

# Coaxial connectors 4.3-10

Edition 2014



# Very stable PIM connector series



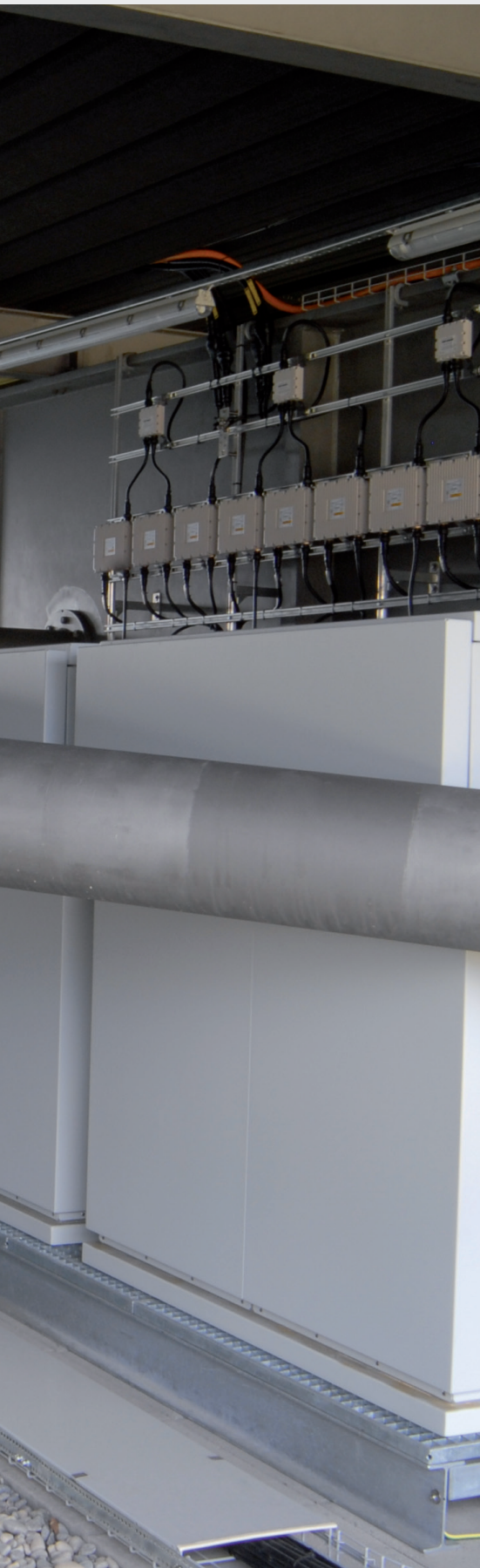

Introduction	4
Technical data	5
Admissible power	6
Cable connectors	7
Receptacle	8
Jumper	9
QUICK-FIT	10
PIM adaptors	11
Calibration with precision adaptors	12
Lightning protectors	13
Lightning protectors for LTE installations	14
Torque wrench	14

### Your partner for system solutions

HUBER+SUHNER is a leading international manufacturer and supplier of components and systems for electrical and optical connectivity. HUBER+SUHNER unites technical expertise in radio frequency technology, fiber optics and low frequency under one roof and offers a high-quality product range for the communication, transport and industrial markets.

HUBER+SUHNER as a global supplier of RF products is an active partner of a developing group designated to provide an innovative solution for the telecom market. The new 4.3-10 connector system is designed to meet the rising performance needs of mobile network equipment and at the same time to reduce its size supporting the ongoing space reduction requirements. This new interface offers very low PIM performance together with weight and compactness advantages.

# Coaxial connectors 4.3-10

The separation of electrical from mechanical plane, which implies a PIM and RL optimized contact independently from the coupling mechanism is a key feature of this connector. This characteristics gives the possibility of offering the connector plug with screw, hand screw and quick lock design, thus simplifying the installation effort and offering for all mechanisms a very high electrical performance.

## Applications

Because of its characteristics the 4.3-10 is the ideal candidate for applications as in new base stations as well as for solutions for distributed antenna systems (DAS), in-building architecture and in small cells applications.

- In base stations the 4.3-10 can be used for interconnections in the remote radio head as well as interface on the antenna and on the jumpers.
- In multi-operator/multiband DAS the 4.3-10 can be used where RF signals have to be combined, terminated, or distributed to the antenna.
- In small cells applications the 4.3-10 is particularly suited for the challenging space restrictions and electrical performances requirements.



## Key features

- Excellent RL and PIM performances independently from the torque applied or mechanism used
- High screening efficiency
- Electrical contact protected against accidental hits
- Compactness: the connector is fitting in 1 inch flange (25.4 mm)
- Low weight (60 % lighter compared to bigger RF interfaces)
- 3 possible mechanical connections (screw, hand screw and quick lock) on 1 universal female connector
- IEC standardization

## Benefits

- High density module design because of smaller flange and a minimum pitch 25.4 mm for hand screw and quick lock
- Light weight modules because of low components weight and no need of thick-walled modules (no torque or small torque required)
- High flexibility in the choice of the best matching coupling mechanism according to the application
- Reliable electrical performance
- Easy installation

# Series 4.3-10 – Technical data

The 4.3-10 interface dimensions conform to the international standards IEC 61169-54.

Electrical data	IEC 61169-1	
Nominal impedance		50 Ω
Frequency range		up to 12 GHz
Reflection factor (interface only)	9.2.1.	0.015 max. DC - 4 GHz 0.025 max. 4 - 6 GHz
Centre and outer contact resistance	9.2.3.	initial ≤ 1.0 mΩ after conditioning ≤ 1.5 mΩ
Insulation resistance	9.2.5.	initial ≥ 5 GΩ after conditioning ≥ 200 MΩ
Proof voltage at sea level r.m.s. values at 40 Hz to 60 Hz	9.2.6.	2500 V
Screening effectiveness • tool tightened • hand tightened & quick-lock	9.2.8.	≥ 120 dB DC - 3 GHz: ≥ 90 dB ; 3 - 6 GHz: ≥ 70 dB
Intermodulation • 2 x 20 W • 2 x 40 W	IEC 62037-3	-166 dBc -160 dBc
Mechanical data	IEC 61169-1	
Mechanical operations	9.5.	> 100 operations
Centre contact captivation (axial force)	9.3.5.	30 N
Coupling torque (screw)	9.3.6.	≥ 5 Nm proof torque: 8 Nm
Engagement force (quick-lock)		typ. 100 N
Separation force (quick-lock)		typ. 80 N
Tensile strength of coupling mechanism (quick-lock)	9.3.11.	≥ 450 N
Vibration	9.3.3.	100 m/s <sup>2</sup> , 10 g acceleration, 2 - 200 Hz
Shock	9.3.14.	981 m/s <sup>2</sup> , 100 g acceleration, 1/2 sin 6 ms
Environmental data	IEC 61169-1	
Temperature range		-55 to +90 °C
Climatic category <sup>1</sup>		55/155/56 40/85/21
Sealing	IEC 60529	IP x8 2.5 bar, 1 h
Salt mist	9.4.6.	duration of spraying 48 h
High temperature endurance	9.6.	250 h at 85 °C

<sup>1</sup>For certain connectors the upper temperature limit is restricted by the cable characteristics. Reference should be made to the relevant cable specification.

Performance listed is typical. Individual part configuration may vary. Contact HUBER+SUHNER for more information and specifications by item number.

## Series 4.3-10 – Admissible power



$T_{amb} = 25\text{ °C} / \text{sea level}$   
 $VSWR = 1.0$

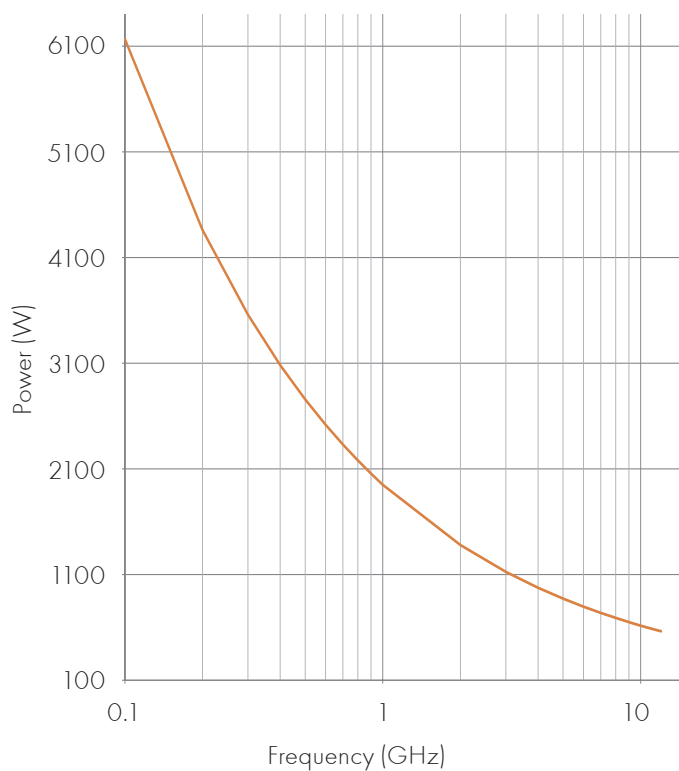

The maximum temperature usually occurs on the connector inner conductor. When connectors are employed in a coaxial cable assembly, the connector should have a center conductor diameter that is equal to or larger than the cable center conductor diameter in order to maximize the power handling of the assembly.

The curves are the results of a typical application and are simulation results. Curves may vary depending on the connector. For specific questions please ask our offices.

# Series 4.3-10 – Cable connectors

## Straight cable plugs (male)

For semi-rigid cables, SUCOFORM and MULTIFLEX cables

- Cable entry soldered
- Centre contact soldered

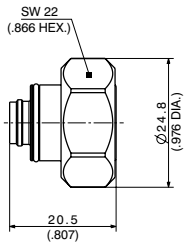

Fig. 1

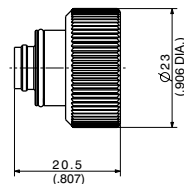

Fig. 2

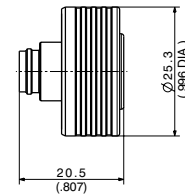

Fig. 3

HUBER+SUHNER type	Item no.	Cable group (example)	Packaging	Fig.
11_4310-50-5-X1/003_-H 11_4310-50-5-X1/003_-E	85020471 85021044	Y14 (SUCOFORM_250-1)	bulk 100 pcs single	1
11_4310-50-5-Y1/003_-H 11_4310-50-5-Y1/003_-E	85020517 85021045	Y14 (SUCOFORM_250-1)	bulk 100 pcs single	2
11_4310-50-5-Z1/003_-H 11_4310-50-5-Z1/003_-E	85020523 85021047	Y14 (SUCOFORM_250-1)	bulk 100 pcs single	3

## Right-angle cable plugs (male)

For semi-rigid cables, SUCOFORM and MULTIFLEX cables

- Cable entry soldered
- Centre contact soldered

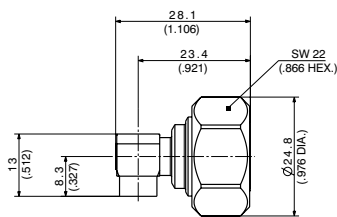

Fig. 1

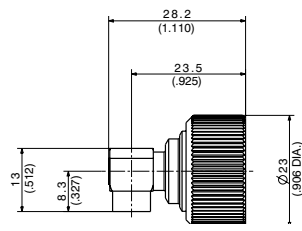

Fig. 2

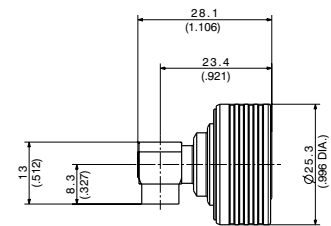

Fig. 3

HUBER+SUHNER type	Item no.	Cable group (example)	Packaging	Fig.
16_4310-50-5-X1/003_-H 16_4310-50-5-X1/003_-E	85020524 85021049	Y14 (SUCOFORM_250-1)	bulk 100 pcs single	1
16_4310-50-5-Y1/003_-H 16_4310-50-5-Y1/003_-E	85020525 85021070	Y14 (SUCOFORM_250-1)	bulk 100 pcs single	2
16_4310-50-5-Z1/003_-H 16_4310-50-5-Z1/003_-E	85020526 85021071	Y14 (SUCOFORM_250-1)	bulk 100 pcs single	3

## Straight cable jacks (female)

For semi-rigid cables, SUCOFORM and MULTIFLEX cables

- Cable entry soldered
- Centre contact soldered

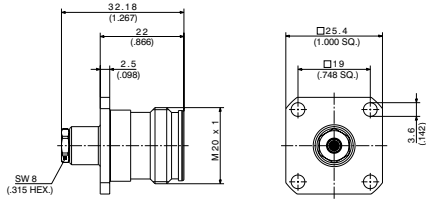

Fig. 1

HUBER+SUHNER type	Item no.	Cable group (example)	Packaging	Fig.
25_4310-50-2-1/003_Y 25_4310-50-2-1/003_E	85020530 85021079	Y16 (SUCOFORM_86)	tray 20 pcs single	1

## Series 4.3-10 - Receptacle

### Straight panel receptacle (jack)

With coaxial end

- 4 hole, 1 inch flange

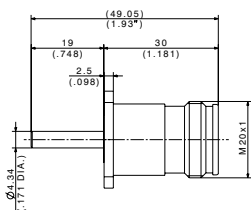

Fig. 1

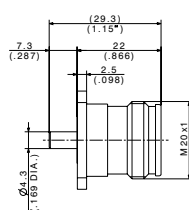

Fig. 2

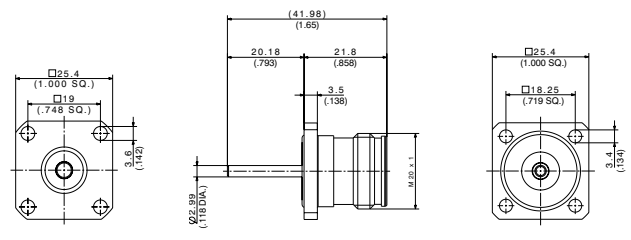

Fig. 3

HUBER+SUHNER type	Item no.	Packaging	Notes	Fig.
23_4310-50-0-1/003_Y 23_4310-50-0-1/003_E	85020598 85021072	tray 40 pcs single		1
23_4310-50-0-2/003_Y 23_4310-50-0-2/003_E	85020599 85021073	tray 60 pcs single		2
23_4310-50-0-5/003_Y 23_4310-50-0-5/003_E	85021011 85020470	tray 60 pcs single	with panel seal	3



# Series 4.3-10 – Jumper

## LISCA assemblies

LISCA cable assemblies are specially developed for applications where low VSWR and low attenuation combined with low intermodulation products are required. The excellent performance is achieved by utilizing corrugated SUCOFEED cables with low intermodulation designed connectors and a controlled assembly process with HUBER+SUHNER solder technology. This product line is designed to provide optimal performance up to 6 GHz.

- Excellent RF performance
- Low attenuation
- Low stable intermodulation products
- Moisture protection IP68



Besides our existing LISCA portfolio, the following 4.3-10 configurations can be ordered:

			Example:	LIS - C9 F - 11 431X - 16 431X - 02000 - 51		
			Product name			
SUCOFEED_1/4_HF	C5		Cable type			
SUCOFEED_3/8_HF	C7					
SUCOFEED_1/2_HF	C9					
SUCOFEED_1/2	C12					
Flame retardant	F		Pattern of connector			
Plenum white	P					
PE	No indication					
Straight male	11		Connector interface			
Right angle male	16					
4.3-10	Type 1: screw Type 2: hand screw Type 3: quick-lock	431X 431Y 431Z		1	2	
			Assembly length in mm			
Jumper performance code	51 52 07		Technical performance			

Other products with 4.3-10 are available on request.

# Series 4.3-10 – QUICK-FIT connectors

QUICK-FIT connectors are designed for the termination of corrugated foam dielectric cables. The HUBER+SUHNER trade name for these cables is SUCOFEED. One unique feature of the HUBER+SUHNER QUICK-FIT connectors is their compatibility with most of the cable brands in the market.

## Key features

- Simplified assembly procedure
- Supplied in one piece
- High quality standard
- Improved PIM performance
- Multi-brand cable compatibility
- Multi-material cable compatibility (copper and aluminium)



## Key benefits

- Quick and easy installation:  
The simplified assembly procedure makes installation quick and easy
- Simplified logistics:  
The connectors are supplied in one piece, which greatly simplifies logistics overall, as well as handling on site
- Very low level of interference of adjacent channels:  
Thanks to their quality and decreased intermodulation distortion, QUICK-FIT connectors ensure a very low level of interference of adjacent channels, meaning that they are the best choice for modern mobile infrastructure
- Wide-ranging applicability:  
Multi-brand/-material cable compatibility ensures wide-ranging applicability

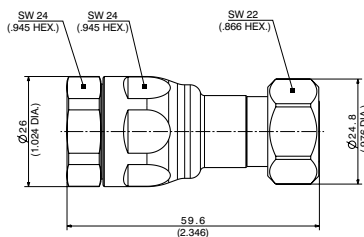

Fig. 1

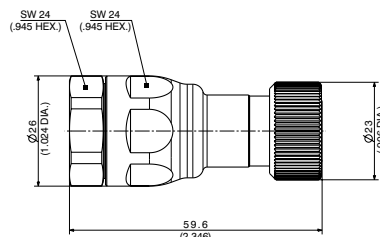

Fig. 2

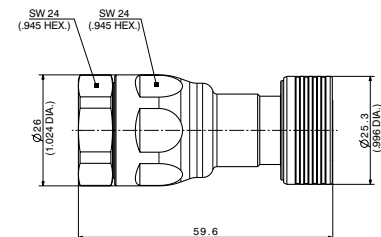

Fig. 3

HUBER+SUHNER type	Connector style	Item no.	Assembly instruction	Stripping tool	Item no. stripping tool	Fig.
11_4310-50-12-X2/003_E	4.3-10	85020537	DOC-0000386367	74_Z-0-12-11	84147226	1
11_4310-50-12-Y2/003_E	4.3-10	85021551	DOC-0000386367	74_Z-0-12-11	84147226	2
11_4310-50-12-Z2/003_E	4.3-10	85021552	DOC-0000386367	74_Z-0-12-11	84147226	3

HUBER+SUHNER field mountable solutions consider mainly HUBER+SUHNER SUCOFEED cables, that guarantee optimal shielding, low attenuation, low VSWR, excellent intermodulation performance and flexibility for handling and installation on sites.

**Cable features**

- Low attenuation design available
- High power capability
- High shielding effectiveness
- UV-resistant
- Guaranteed performance up to 3 GHz



Following table shows the availability of cable entry types according to cable dimension.

Cable type	Filed mountable	LISCA assemblies
1/4" HF	-	•
3/8" HF	-	•
1/2" HF	QUICK-FIT	•
1/2"	QUICK-FIT	•
7/8"	QUICK-FIT*	-

\* on request

## Series 4.3-10 – PIM adaptors

Between series adaptors 7/16 – 4.3-10

- Intermodulation < 166 dB, 2 x 20 W, 1.8 GHz
- RL < 28 dB, DC – 6 GHz

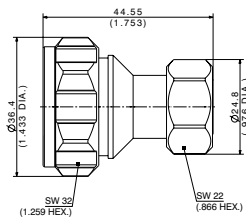

Fig. 1

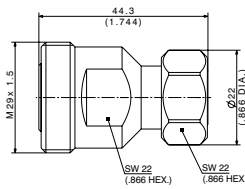

Fig. 2

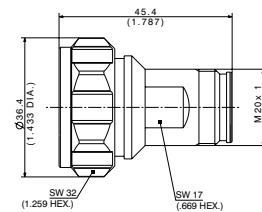
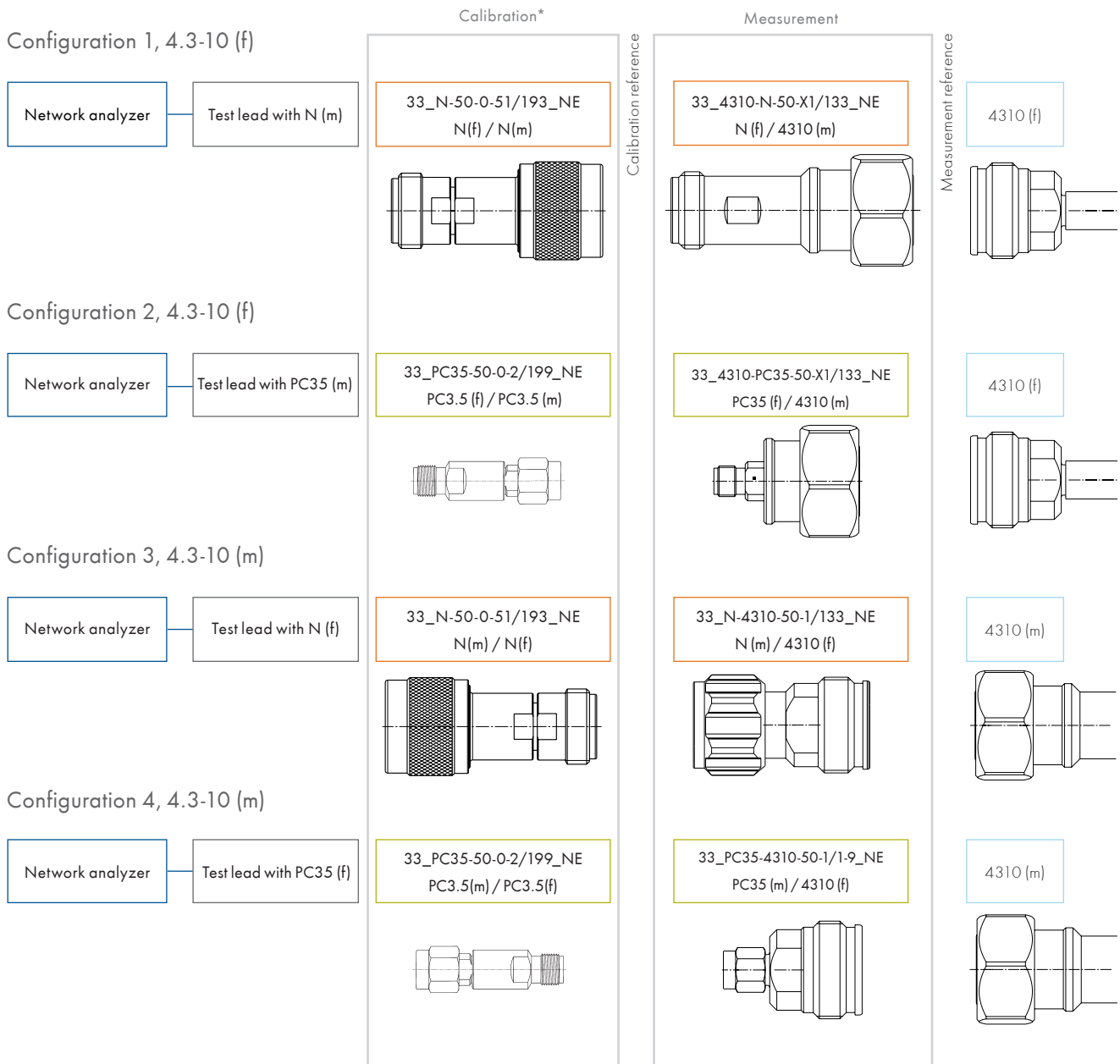

Fig. 3

HUBER+SUHNER type	Item no.	Description	Packaging	Fig.
32_4310-716-50-X1/133_WE	85017233	4310 male (type1), 7/16 male	single	1
33_4310-716-50-X1/133_WE	85017237	4310 male (type1), 7/16 female		2
33_716-4310-50-1/133_WE	85017213	4310 female, 7/16 male		3

# Series 4.3-10 – Calibration with precision adaptors (swapping method)

For return loss/VSWR measurements of 4.3-10 connectors, HUBER+SUHNER recommends the following calibration method. Depending on the 4.3-10 side (male or female) or ports on the test leads, different configurations are possible. Four different configurations with PC3.5 calibration kits or precision N calibration kits are listed below:



\*The calibration connectors need to be swapped and replaced by the corresponding 4.3-10 adaptors

# Series 4.3-10 – Lightning protectors

Highest reliability, lowest risk, fast site approval, reduced maintenance cost

The perfect coaxial lightning protector for LTE installations is the one which archives best protection results while at the same time not degrading the RF systems performance at all. Starting with the RF performance this means that it shall accomplish the full LTE bandwidth (690 - 2700 MHz) with highest possible return loss (RL). LTE is a high power, multicarrier application which demands lowest passive intermodulation products distortion. Certainly the lightning protection parameters shall be of the highest standards in order to increase system reliability, lower risk and reduce maintenance cost.

## QW Quarter-wave shorting stub technology

For all applications which do not apply DC power on the feeder cable our LP 3400.31.0001 (quarter-wave shorting stub principle) with its excellent lightning protection parameters represents the best possible technology.

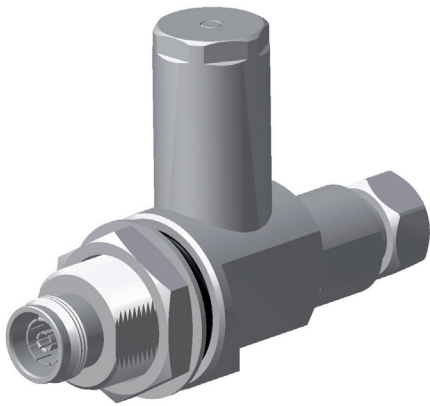

3400.31.0001

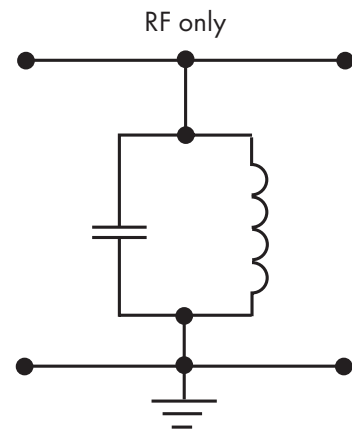

Quarter-wave ( $\lambda/4$ ) shorting stub

## GDT gas discharge tube hybrid technology

Applications in which RF and DC are applied on the feeder line are best served with the 3409.31.0001 protector (GDT hybrid technology). This lightning protector performs lowest passive intermodulation values and can handle peak envelope power (PIP) up to 25 kW.

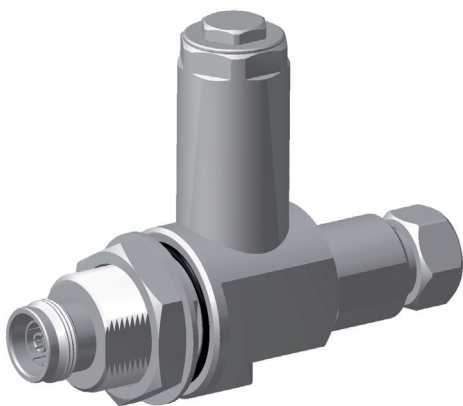

3409.31.0001

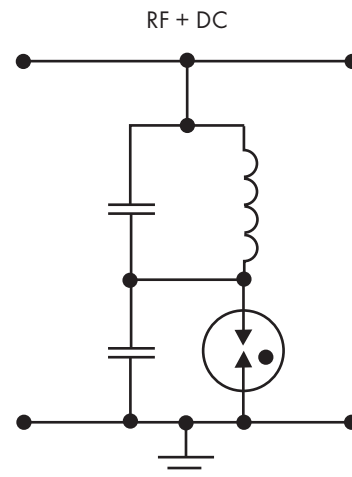

GDT on top of QW shorting stub

## Series 4.3-10 – Lightning protectors for LTE installations

H+S type	Frequency range (MHz)	Connectors	RL min. (dB)	IL max. (dB)	PIM max. (dBc)	Residual energy typical ( $\mu$ J)	Current handling capability (single/multiple) (kA)	Fig.
3400.31.0001	690-2700	4.3-10	26	0.1	-160	11	100/80	1
3409.31.0001	690-2700	4.3-10	26	0.1	-160	350	30/20	2

The frequency range covers the full LTE band and therefore includes public safety, WiMAX, WLAN, ISM and GPS applications besides the classic cellular applications.

Both protectors are IP67 rated (in coupled state) for outdoor installations.

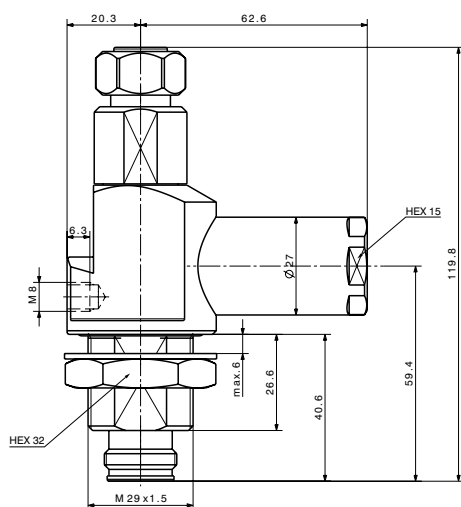

Fig. 1

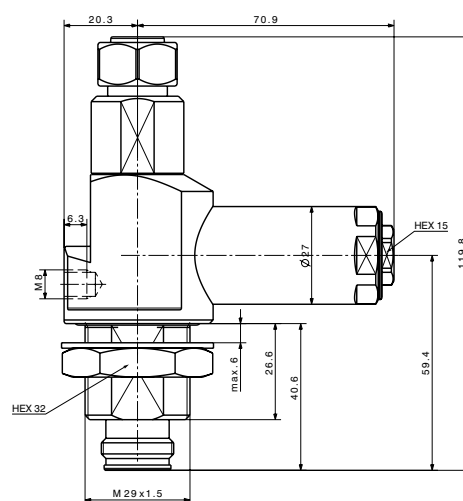
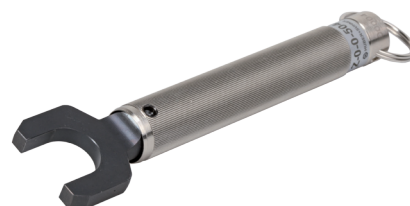

Fig. 2

More applications about lightning protection can be found in the HUBER+SUHNER Lightning Protection catalogue.

## Series 4.3-10 – Torque wrench

Suitable for 4.3-10 screw type.



H+S type	Item no.	For series	Torque	Opening
74_Z0-0-504	85020152	4.3-10	5 Nm	22 mm

## Online catalogues



RF coaxial connectors  
General catalogue

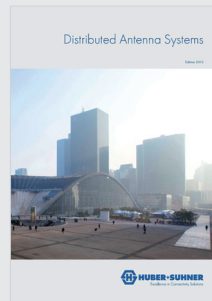

Distributed Antenna Systems  
Brochure



Distributed Antenna Systems (DAS)  
RF products  
General catalogue



Wireless infrastructures – Solutions  
for remote radio and cell sites  
General catalogue



HUBER+SUHNER AG  
Radio Frequency Division  
Degersheimerstrasse 14  
9100 Herisau  
Switzerland  
Phone +41 71 353 4111  
Fax +41 71 353 4444  
hubersuhner.com

HUBER+SUHNER is certified according to EN (AS) 9100, ISO 9001, ISO 14001, ISO/TS 16949 and IRIS.

**Waiver**

Fact and figures herein are for information only and do not represent any warranty of any kind.

