

TLC225x, TLC225xA
Advanced LinCMOS™ RAIL-TO-RAIL
VERY LOW-POWER OPERATIONAL AMPLIFIERS

SLOS176D – FEBRUARY 1997 – REVISED MARCH 2001

- **Output Swing Includes Both Supply Rails**
- **Low Noise . . . 19 nV/√Hz Typ at f = 1 kHz**
- **Low Input Bias Current . . . 1 pA Typ**
- **Fully Specified for Both Single-Supply and Split-Supply Operation**
- **Very Low Power . . . 35 μA Per Channel Typ**
- **Common-Mode Input Voltage Range Includes Negative Rail**
- **Low Input Offset Voltage**
850 μV Max at T_A = 25°C (TLC225xA)
- **Macromodel Included**
- **Performance Upgrades for the TS27L2/L4 and TLC27L2/L4**
- **Available in Q-Temp Automotive HighRel Automotive Applications Configuration Control / Print Support Qualification to Automotive Standards**

description

The TLC2252 and TLC2254 are dual and quadruple operational amplifiers from Texas Instruments. Both devices exhibit rail-to-rail output performance for increased dynamic range in single- or split-supply applications. The TLC225x family consumes only 35 μA of supply current per channel. This micropower operation makes them good choices for battery-powered applications. The noise performance has been dramatically improved over previous generations of CMOS amplifiers. Looking at Figure 1, the TLC225x has a noise level of 19 nV/√Hz at 1kHz; four times lower than competitive micropower solutions.

The TLC225x amplifiers, exhibiting high input impedance and low noise, are excellent for small-signal conditioning for high-impedance sources, such as piezoelectric transducers. Because of the micropower dissipation levels, these devices work well in hand-held monitoring and remote-sensing applications. In addition, the rail-to-rail output feature with single or split supplies makes this family a great choice when interfacing with analog-to-digital converters (ADCs). For precision applications, the TLC225xA family is available and has a maximum input offset voltage of 850 μV. This family is fully characterized at 5 V and ±5 V.

The TLC2252/4 also makes great upgrades to the TLC27L2/L4 or TS27L2/L4 in standard designs. They offer increased output dynamic range, lower noise voltage, and lower input offset voltage. This enhanced feature set allows them to be used in a wider range of applications. For applications that require higher output drive and wider input voltage ranges, see the TLV2432 and TLV2442 devices. If the design requires single amplifiers, please see the TLV2211/21/31 family. These devices are single rail-to-rail operational amplifiers in the SOT-23 package. Their small size and low power consumption, make them ideal for high density, battery-powered equipment.

**EQUIVALENT INPUT NOISE VOLTAGE
vs
FREQUENCY**

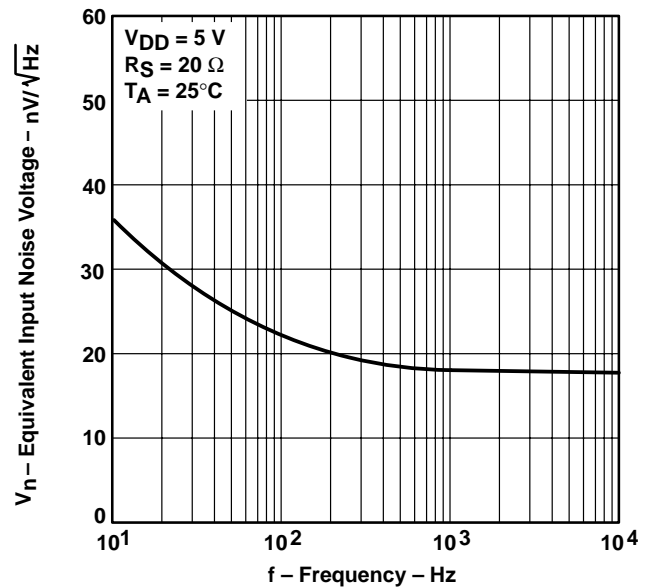

Figure 1



Please be aware that an important notice concerning availability, standard warranty, and use in critical applications of Texas Instruments semiconductor products and disclaimers thereto appears at the end of this data sheet.

Advanced LinCMOS is a trademark of Texas Instruments.

PRODUCTION DATA information is current as of publication date. Products conform to specifications per the terms of Texas Instruments standard warranty. Production processing does not necessarily include testing of all parameters.



POST OFFICE BOX 655303 • DALLAS, TEXAS 75265

Copyright © 2001, Texas Instruments Incorporated
 On products compliant to MIL-PRF-38535, all parameters are tested unless otherwise noted. On all other products, production processing does not necessarily include testing of all parameters.

TLC225x, TLC225xA
Advanced LinCMOS™ RAIL-TO-RAIL
VERY LOW-POWER OPERATIONAL AMPLIFIERS

SLOS176D – FEBRUARY 1997 – REVISED MARCH 2001

TLC2252 AVAILABLE OPTIONS

| T _A | V _{IO} max AT 25°C | PACKAGED DEVICES | | | | | |
|----------------|--------------------------------|--------------------------|---------------------------|---------------------------|-------------------------|------------------|----------------------------|
| | | SMALL OUTLINE† (D) | CHIP CARRIER (FK) | CERAMIC DIP (JG) | PLASTIC DIP (P) | TSSOP‡ (PW) | CERAMIC FLATPACK (U) |
| 0°C to 70°C | 1500 µV | TLC2252CD | — | — | TLC2252CP | TLC2252CPW | — |
| –40°C to 125°C | 850 µV 1500 µV | TLC2252AID TLC2252ID | — — | — — | TLC2252AIP TLC2252IP | TLC2252AIPW — | — — |
| –40°C to 125°C | 850 µV 1500 µV | TLC2252AQD TLC2252QD | — — | — — | — — | — — | — — |
| –55°C to 125°C | 850 µV 1500 µV | — — | TLC2252AMFK TLC2252MFK | TLC2252AMJG TLC2252MJG | — — | — — | TLC2252AMU TLC2252MU |

† The D packages are available taped and reeled. Add R suffix to device type (e.g., TLC2262CDR).

‡ The PW package is available only left-ended taped and reeled.

§ Chip forms are tested at 25°C only.

TLC2254 AVAILABLE OPTIONS

| T _A | V _{IO} max AT 25°C | PACKAGED DEVICES | | | | | |
|-------------------|--------------------------------|--------------------------|---------------------------|-------------------------|-------------------------|------------------|----------------------------|
| | | SMALL OUTLINE† (D) | CHIP CARRIER (FK) | CERAMIC DIP (J) | PLASTIC DIP (N) | TSSOP‡ (PW) | CERAMIC FLATPACK (W) |
| 0°C to 70°C | 1500 µV | TLC2254CD | — | — | TLC2254CN | TLC2254CPW | — |
| –40°C to 125°C | 850 µV 1500 µV | TLC2254AID TLC2254ID | — — | — — | TLC2254AIN TLC2254IN | TLC2254AIPW — | — — |
| –40°C to 125°C | 850 µV 1500 µV | TLC2254AQD TLC2254QD | — — | — — | — — | — — | — — |
| –55°C to 125°C | 850 µV 1500 µV | — — | TLC2254AMFK TLC2254MFK | TLC2254AMJ TLC2254MJ | — — | — — | TLC2254AMW TLC2254MW |

† The D packages are available taped and reeled. Add R suffix to the device type (e.g., TLC2254CDR).

‡ The PW package is available only left-end taped and reeled. Chips are tested at 25°C.

§ Chip forms are tested at 25°C only.



TLC225x, TLC225xA
Advanced LinCMOS™ RAIL-TO-RAIL
VERY LOW-POWER OPERATIONAL AMPLIFIERS

SLOS176D – FEBRUARY 1997 – REVISED MARCH 2001

TLC2252C, TLC2252AC
TLC2252I, TLC2252AI
TLC2252Q, TLC2252AQ
D, P, OR PW PACKAGE
(TOP VIEW)

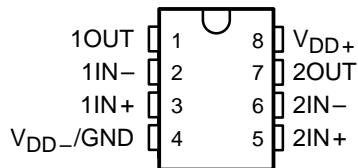

TLC2252M, TLC2252AM ... FK PACKAGE
(TOP VIEW)

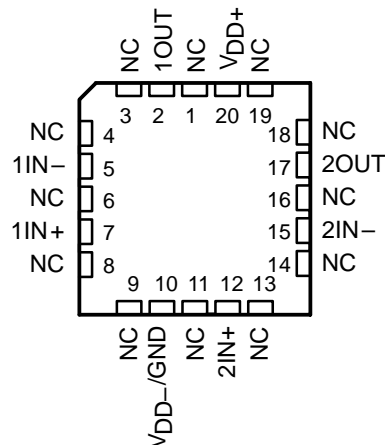

TLC2252M, TLC2252AM ... JG PACKAGE
(TOP VIEW)

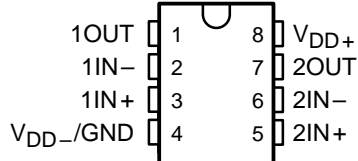

TLC2262M, TLC2252AM ... U PACKAGE
(TOP VIEW)

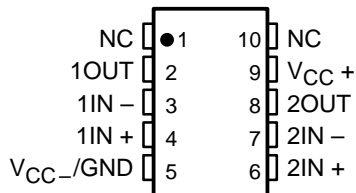

TLC2254C, TLC2254AC
TLC2254I, TLC2254AI
TLC2254Q, TLC2254AQ
D, N, OR PW PACKAGE
(TOP VIEW)



TLC2254M, TLC2254AM
J OR W PACKAGE
(TOP VIEW)



TLC2254M, TLC2254AM
FK PACKAGE
(TOP VIEW)

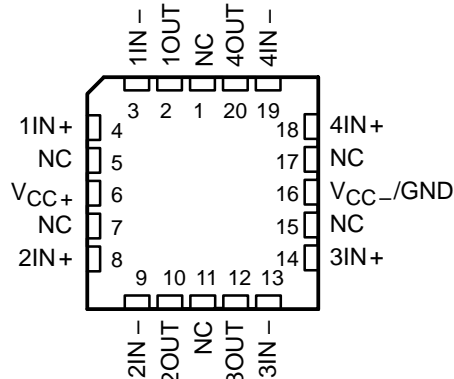

NC – No internal connection

TLC225x, TLC225xA
Advanced LinCMOS™ RAIL-TO-RAIL
VERY LOW-POWER OPERATIONAL AMPLIFIERS

SLOS176D – FEBRUARY 1997 – REVISED MARCH 2001

equivalent schematic (each amplifier)

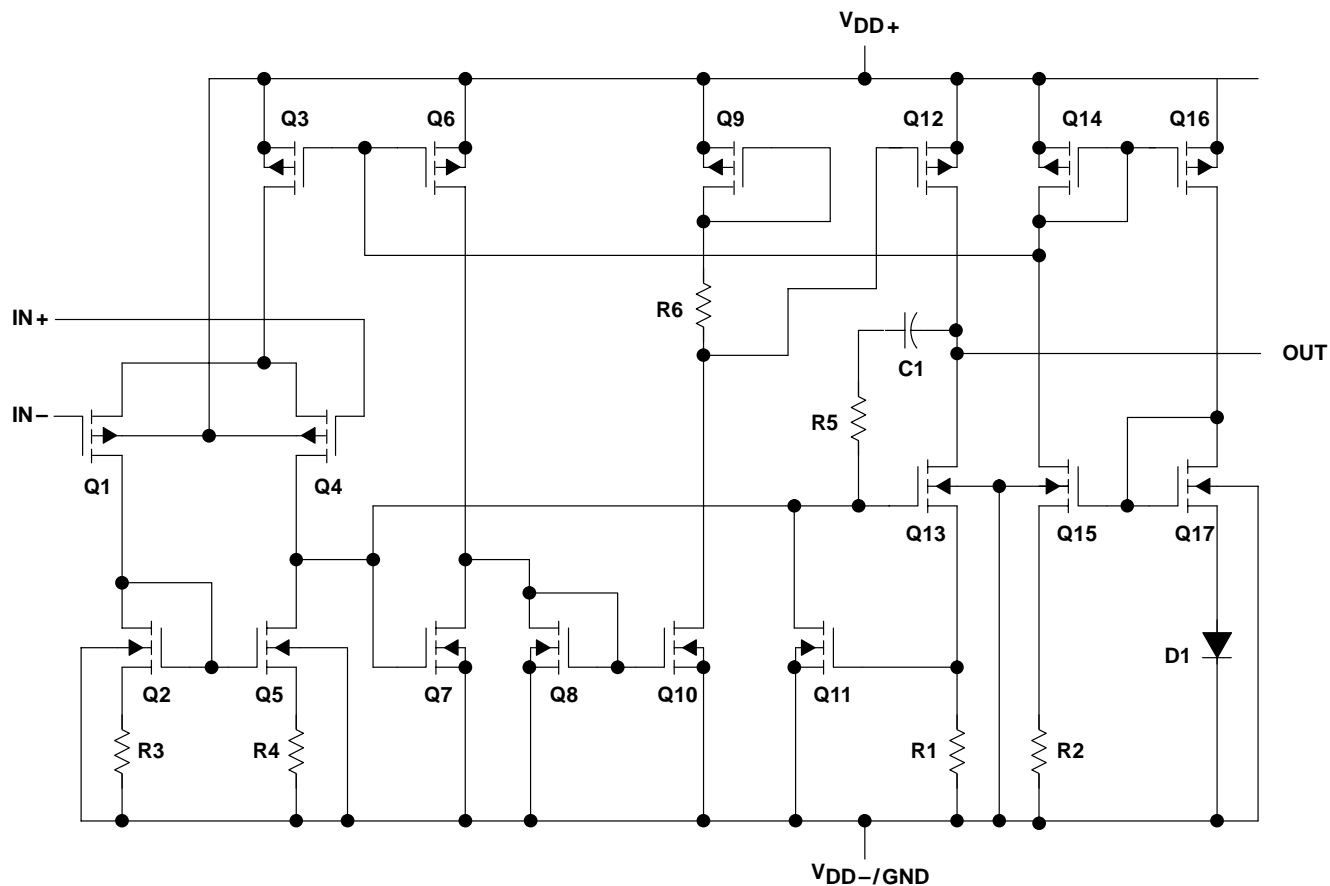

| ACTUAL DEVICE COMPONENT COUNT† | | |
|--------------------------------|---------|---------|
| COMPONENT | TLC2252 | TLC2254 |
| Transistors | 38 | 76 |
| Resistors | 30 | 56 |
| Diodes | 9 | 18 |
| Capacitors | 3 | 6 |

† Includes both amplifiers and all ESD, bias, and trim circuitry



POST OFFICE BOX 655303 • DALLAS, TEXAS 75265

absolute maximum ratings over operating free-air temperature range (unless otherwise noted)†

| | |
|-------------------------------------------------------------------|------------------------------|
| Supply voltage, V_{DD+} (see Note 1) | 8 V |
| Supply voltage, V_{DD-} (see Note 1) | –8 V |
| Differential input voltage, V_{ID} (see Note 2) | ±16 V |
| Input voltage, V_I (any input, see Note 1) | ±8 V |
| Input current, I_I (each input) | ±5 mA |
| Output current, I_O | ±50 mA |
| Total current into V_{DD+} | ±50 mA |
| Total current out of V_{DD-} | ±50 mA |
| Duration of short-circuit current at (or below) 25°C (see Note 3) | unlimited |
| Continuous total dissipation | See Dissipation Rating Table |
| Operating free-air temperature range, T_A : C suffix | 0°C to 70°C |
| I suffix | –40°C to 125°C |
| Q suffix | –40°C to 125°C |
| M suffix | –55°C to 125°C |
| Storage temperature range, T_{stg} | –65°C to 150°C |
| Lead temperature 1,6 mm (1/16 inch) from case for 10 seconds | 260°C |

† Stresses beyond those listed under “absolute maximum ratings” may cause permanent damage to the device. These are stress ratings only, and functional operation of the device at these or any other conditions beyond those indicated under “recommended operating conditions” is not implied. Exposure to absolute-maximum-rated conditions for extended periods may affect device reliability.

- NOTES: 1. All voltage values, except differential voltages, are with respect to the midpoint between V_{DD+} and V_{DD-} .
 2. Differential voltages are at $IN+$ with respect to $IN-$. Excessive current flows when input is brought below $V_{DD-} - 0.3$ V.
 3. The output may be shorted to either supply. Temperature and/or supply voltages must be limited to ensure that the maximum dissipation rating is not exceeded.

DISSIPATION RATING TABLE

| PACKAGE | $T_A \leq 25^\circ\text{C}$ POWER RATING | DERATING FACTOR ABOVE $T_A = 25^\circ\text{C}$ | $T_A = 70^\circ\text{C}$ POWER RATING | $T_A = 85^\circ\text{C}$ POWER RATING | $T_A = 125^\circ\text{C}$ POWER RATING |
|---------|---------------------------------------------|---------------------------------------------------|------------------------------------------|------------------------------------------|-------------------------------------------|
| D–8 | 724 mW | 5.8 mW/°C | 464 mW | 377 mW | 144 mW |
| D–14 | 950 mW | 7.6 mW/°C | 608 mW | 450 mW | 190 mW |
| FK | 1375 mW | 11.0 mW/°C | 880 mW | 715 mW | 275 mW |
| J | 1375 mW | 11.0 mW/°C | 880 mW | 715 mW | 275 mW |
| JG | 1050 mW | 8.4 mW/°C | 672 mW | 546 mW | 275 mW |
| N | 1150 mW | 9.2 mW/°C | 736 mW | 736 mW | — |
| P | 1000 mW | 8.0 mW/°C | 640 mW | 520 mW | — |
| PW–8 | 525 mW | 4.2 mW/°C | 336 mW | 273 mW | — |
| PW–14 | 700 mW | 5.6 mW/°C | 448 mW | 448 mW | — |
| U | 700 mW | 5.5 mW/°C | 246 mW | 330 mW | 150 mW |
| W | 700 mW | 5.5 mW/°C | 246 mW | 330 mW | 150 mW |

recommended operating conditions

| | C SUFFIX | | I SUFFIX | | Q SUFFIX | | M SUFFIX | | UNIT |
|---------------------------------------|-----------|-----------------|-----------|-----------------|-----------|-----------------|-----------|-----------------|------|
| | MIN | MAX | MIN | MAX | MIN | MAX | MIN | MAX | |
| Supply voltage, $V_{DD\pm}$ | ±2.2 | ±8 | ±2.2 | ±8 | ±2.2 | ±8 | ±2.2 | ±8 | V |
| Input voltage range, V_I | V_{DD-} | $V_{DD+} - 1.5$ | V_{DD-} | $V_{DD+} - 1.5$ | V_{DD-} | $V_{DD+} - 1.5$ | V_{DD-} | $V_{DD+} - 1.5$ | V |
| Common-mode input voltage, V_{IC} | V_{DD-} | $V_{DD+} - 1.5$ | V_{DD-} | $V_{DD+} - 1.5$ | V_{DD-} | $V_{DD+} - 1.5$ | V_{DD-} | $V_{DD+} - 1.5$ | V |
| Operating free-air temperature, T_A | 0 | 70 | –40 | 125 | –40 | 125 | –55 | 125 | °C |

TLC225x, TLC225xA
Advanced LinCMOS™ RAIL-TO-RAIL
VERY LOW-POWER OPERATIONAL AMPLIFIERS

SLOS176D – FEBRUARY 1997 – REVISED MARCH 2001

electrical characteristics at specified free-air temperature, $V_{DD} = 5\text{ V}$ (unless otherwise noted)

| PARAMETER | TEST CONDITIONS | T_A † | TLC2252C | | | UNIT |
|----------------------------------------------------------------------------|---------------------------------------------------------------------------------------|--------------------------------------------------------------|------------------------------|-------------|------------------------------|------|
| | | | MIN | TYP | MAX | |
| V_{IO} Input offset voltage | $V_{IC} = 0,$ $V_O = 0,$ $V_{DD} \pm = \pm 2.5\text{ V},$ $R_S = 50\ \Omega$ | 25°C | 200 | 1500 | μV | |
| | | Full range | 1750 | | | |
| α_{VIO} Temperature coefficient of input offset voltage | | 25°C to 70°C | 0.5 | | $\mu\text{V}/^\circ\text{C}$ | |
| Input offset voltage long-term drift (see Note 4) | | 25°C | 0.003 | | $\mu\text{V}/\text{mo}$ | |
| I_{IO} Input offset current | | 25°C | 0.5 | 60 | pA | |
| | | Full range | 100 | | | |
| I_{IB} Input bias current | | 25°C | 1 | 60 | pA | |
| | | Full range | 100 | | | |
| V_{ICR} Common-mode input voltage range | $R_S = 50\ \Omega,$ $ V_{IO} \leq 5\text{ mV}$ | 25°C | 0 to 4 | -0.3 to 4.2 | V | |
| | | Full range | 0 to 3.5 | | | |
| V_{OH} High-level output voltage | $I_{OH} = -20\ \mu\text{A}$ | 25°C | 4.98 | | V | |
| | $I_{OH} = -75\ \mu\text{A}$ | 25°C | 4.9 | 4.94 | | |
| | Full range | 4.8 | | | | |
| | $I_{OH} = -150\ \mu\text{A}$ | 25°C | 4.8 | 4.88 | | |
| V_{OL} Low-level output voltage | $V_{IC} = 2.5\text{ V},$ $I_{OL} = 50\ \mu\text{A}$ | 25°C | 0.01 | | V | |
| | $V_{IC} = 2.5\text{ V},$ $I_{OL} = 500\ \mu\text{A}$ | 25°C | 0.09 | 0.15 | | |
| | | Full range | 0.15 | | | |
| | $V_{IC} = 2.5\text{ V},$ $I_{OL} = 1\text{ mA}$ | 25°C | 0.2 | 0.3 | | |
| | | Full range | 0.3 | | | |
| | $V_{IC} = 2.5\text{ V},$ $I_{OL} = 4\text{ mA}$ | 25°C | 0.7 | 1 | | |
| | | Full range | 1.2 | | | |
| | A_{VD} Large-signal differential voltage amplification | $V_{IC} = 2.5\text{ V},$ $V_O = 1\text{ V to }4\text{ V}$ | $R_L = 100\text{ k}\Omega$ ‡ | 25°C | | 100 |
| $R_L = 1\text{ M}\Omega$ ‡ | | | Full range | 10 | | |
| | | | 25°C | 1700 | | |
| r_{id} Differential input resistance | | 25°C | 10^{12} | | Ω | |
| r_{ic} Common-mode input resistance | | 25°C | 10^{12} | | Ω | |
| c_{ic} Common-mode input capacitance | $f = 10\text{ kHz},$ P package | 25°C | 8 | | pF | |
| z_o Closed-loop output impedance | $f = 25\text{ kHz},$ $A_V = 10$ | 25°C | 200 | | Ω | |
| CMRR Common-mode rejection ratio | $V_{IC} = 0\text{ to }2.7\text{ V},$ $V_O = 2.5\text{ V},$ $R_S = 50\ \Omega$ | 25°C | 70 | 83 | dB | |
| | | Full range | 70 | | | |
| k_{SVR} Supply-voltage rejection ratio ($\Delta V_{DD}/\Delta V_{IO}$) | $V_{DD} = 4.4\text{ V to }16\text{ V},$ $V_{IC} = V_{DD}/2,$ No load | 25°C | 80 | 95 | dB | |
| | | Full range | 80 | | | |
| I_{DD} Supply current | $V_O = 2.5\text{ V},$ No load | 25°C | 70 | 125 | μA | |
| | | Full range | 150 | | | |

† Full range is 0°C to 70°C.

‡ Referenced to 2.5 V

NOTE 4: Typical values are based on the input offset voltage shift observed through 500 hours of operating life test at $T_A = 150^\circ\text{C}$ extrapolated to $T_A = 25^\circ\text{C}$ using the Arrhenius equation and assuming an activation energy of 0.96 eV.



TLC225x, TLC225xA
Advanced LinCMOS™ RAIL-TO-RAIL
VERY LOW-POWER OPERATIONAL AMPLIFIERS

SLOS176D – FEBRUARY 1997 – REVISED MARCH 2001

operating characteristics at specified free-air temperature, $V_{DD} = 5\text{ V}$

| PARAMETER | | TEST CONDITIONS | | T_A † | TLC2252C | | | UNIT |
|-----------------|---------------------------------------------|-------------------------------------------------------------------------------------------------------|--|------------|-----------------------------------------|------|------------------------|------|
| | | | | | MIN | TYP | MAX | |
| SR | Slew rate at unity gain | $V_O = 1.5\text{ V to }3.5\text{ V}, R_L = 100\text{ k}\Omega^\ddagger, C_L = 100\text{ pF}^\ddagger$ | | 25°C | 0.07 | 0.12 | V/ μs | |
| | | | | Full range | 0.05 | | | |
| V_n | Equivalent input noise voltage | f = 10 Hz | | 25°C | 36 | | nV/ $\sqrt{\text{Hz}}$ | |
| | | f = 1 kHz | | 25°C | 19 | | | |
| $V_{N(PP)}$ | Peak-to-peak equivalent input noise voltage | f = 0.1 Hz to 1 Hz | | 25°C | 0.7 | | μV | |
| | | f = 0.1 Hz to 10 Hz | | 25°C | 1.1 | | | |
| I_n | Equivalent input noise current | | | 25°C | 0.6 | | fA/ $\sqrt{\text{Hz}}$ | |
| THD + N | Total harmonic distortion plus noise | $V_O = 0.5\text{ V to }2.5\text{ V}, f = 10\text{ kHz}, R_L = 50\text{ k}\Omega^\ddagger$ | | 25°C | $A_V = 1$ | | | |
| | | | | | $A_V = 10$ | | | |
| | Gain-bandwidth product | f = 10 kHz, $R_L = 50\text{ k}\Omega^\ddagger, C_L = 100\text{ pF}^\ddagger$ | | 25°C | 0.2 | | MHz | |
| B _{OM} | Maximum output-swing bandwidth | $V_{O(PP)} = 2\text{ V}, R_L = 50\text{ k}\Omega^\ddagger,$ | | 25°C | $A_V = 1, C_L = 100\text{ pF}^\ddagger$ | | kHz | |
| ϕ_m | Phase margin at unity gain | $R_L = 50\text{ k}\Omega^\ddagger,$ | | | $C_L = 100\text{ pF}^\ddagger$ | | | |
| | Gain margin | | | 25°C | 15 | | dB | |

† Full range is 0°C to 70°C.

‡ Referenced to 2.5 V

TLC225x, TLC225xA
Advanced LinCMOS™ RAIL-TO-RAIL
VERY LOW-POWER OPERATIONAL AMPLIFIERS

SLOS176D – FEBRUARY 1997 – REVISED MARCH 2001

electrical characteristics at specified free-air temperature, $V_{DD\pm} = \pm 5\text{ V}$ (unless otherwise specified)

| PARAMETER | TEST CONDITIONS | T _A † | TLC2252C | | | UNIT |
|----------------------------------------------------------------------------------------|-------------------------------------------------------------------------------|-------------------------|------------------|-------------|-------|------|
| | | | MIN | TYP | MAX | |
| V _{IO} Input offset voltage | V _{IC} = 0, V _O = 0, R _S = 50 Ω | 25°C | 200 | 1500 | μV | |
| | | Full range | 1750 | | | |
| αV _{IO} Temperature coefficient of input offset voltage | | 25°C to 70°C | 0.5 | | μV/°C | |
| Input offset voltage long-term drift (see Note 4) | | 25°C | 0.003 | | μV/mo | |
| I _{IO} Input offset current | | 25°C | 0.5 | 60 | pA | |
| | | Full range | 100 | | | |
| I _{IB} Input bias current | | 25°C | 1 | 60 | pA | |
| | | Full range | 100 | | | |
| V _{ICR} Common-mode input voltage range | V _{IO} ≤ 5 mV, R _S = 50 Ω | 25°C | -5 to 4 | -5.3 to 4.2 | V | |
| | | Full range | -5 to 3.5 | | | |
| V _{OM+} Maximum positive peak output voltage | I _O = -20 μA | 25°C | 4.98 | | V | |
| | I _O = -100 μA | 25°C | 4.9 | 4.93 | | |
| | | Full range | 4.7 | | | |
| | I _O = -200 μA | 25°C | 4.8 | 4.86 | | |
| V _{OM-} Maximum negative peak output voltage | V _{IC} = 0, I _O = 50 μA | 25°C | -4.99 | | V | |
| | | 25°C | -4.85 | -4.91 | | |
| | V _{IC} = 0, I _O = 500 μA | Full range | -4.85 | | | |
| | | 25°C | -4.7 | -4.8 | | |
| | V _{IC} = 0, I _O = 1 mA | Full range | -4.7 | | | |
| | | 25°C | -4 | -4.3 | | |
| | V _{IC} = 0, I _O = 4 mA | Full range | -3.8 | | | |
| | | 25°C | 45 | 650 | | V/mV |
| A _{VD} Large-signal differential voltage amplification | V _O = ±4 V | R _L = 100 kΩ | 10 | | | |
| | | R _L = 1 MΩ | 3000 | | | |
| r _{id} Differential input resistance | | 25°C | 10 ¹² | | Ω | |
| r _{ic} Common-mode input resistance | | 25°C | 10 ¹² | | Ω | |
| c _{ic} Common-mode input capacitance | f = 10 kHz, P package | 25°C | 8 | | pF | |
| z _o Closed-loop output impedance | f = 25 kHz, A _V = 10 | 25°C | 190 | | Ω | |
| CMRR Common-mode rejection ratio | V _{IC} = -5 V to 2.7 V, V _O = 0, R _S = 50 Ω | 25°C | 75 | 88 | dB | |
| | | Full range | 75 | | | |
| k _{SVR} Supply-voltage rejection ratio (ΔV _{DD±} /ΔV _{IO}) | V _{DD±} = 2.2 V to ±8 V, V _{IC} = 0, No load | 25°C | 80 | 95 | dB | |
| | | Full range | 80 | | | |
| I _{DD} Supply current | V _O = 0, No load | 25°C | 80 | 125 | μA | |
| | | Full range | 150 | | | |

† Full range is 0°C to 70°C.

NOTE 4: Typical values are based on the input offset voltage shift observed through 500 hours of operating life test at T_A = 150°C extrapolated to T_A = 25°C using the Arrhenius equation and assuming an activation energy of 0.96 eV.



TLC225x, TLC225xA
Advanced LinCMOS™ RAIL-TO-RAIL
VERY LOW-POWER OPERATIONAL AMPLIFIERS

SLOS176D – FEBRUARY 1997 – REVISED MARCH 2001

operating characteristics at specified free-air temperature, $V_{DD\pm} = \pm 5\text{ V}$

| PARAMETER | TEST CONDITIONS | T_A † | TLC2252C | | | UNIT |
|---------------------------------------------------------|-----------------------------------------------------------------------------------------------------|------------|----------|------|------------------------|------------|
| | | | MIN | TYP | MAX | |
| SR Slew rate at unity gain | $V_O = \pm 1.9\text{ V}$, $C_L = 100\text{ pF}$, $R_L = 100\text{ k}\Omega$ | 25°C | 0.07 | 0.12 | | V/ μ s |
| | | Full range | 0.05 | | | |
| V_n Equivalent input noise voltage | $f = 10\text{ Hz}$ | 25°C | 38 | | nV/ $\sqrt{\text{Hz}}$ | |
| | $f = 1\text{ kHz}$ | 25°C | 19 | | | |
| $V_{N(PP)}$ Peak-to-peak equivalent input noise voltage | $f = 0.1\text{ Hz to }1\text{ Hz}$ | 25°C | 0.8 | | μ V | |
| | $f = 0.1\text{ Hz to }10\text{ Hz}$ | 25°C | 1.1 | | | |
| I_n Equivalent input noise current | | 25°C | 0.6 | | fA/ $\sqrt{\text{Hz}}$ | |
| THD + N Total harmonic distortion pulse duration | $V_O = \pm 2.3\text{ V}$, $f = 10\text{ kHz}$, $R_L = 50\text{ k}\Omega$ | $A_V = 1$ | 0.2% | | | |
| | | $A_V = 10$ | 1% | | | |
| Gain-bandwidth product | $f = 10\text{ kHz}$, $C_L = 100\text{ pF}$, $R_L = 50\text{ k}\Omega$ | 25°C | 0.21 | | MHz | |
| B_{OM} Maximum output-swing bandwidth | $V_{O(PP)} = 4.6\text{ V}$, $R_L = 50\text{ k}\Omega$, $A_V = 1$, $C_L = 100\text{ pF}$ | 25°C | 14 | | kHz | |
| ϕ_m Phase margin at unity gain | $R_L = 50\text{ k}\Omega$, $C_L = 100\text{ pF}$ | 25°C | 63° | | | |
| Gain margin | | 25°C | 15 | | dB | |

† Full range is 0°C to 70°C.

TLC225x, TLC225xA
Advanced LinCMOS™ RAIL-TO-RAIL
VERY LOW-POWER OPERATIONAL AMPLIFIERS

SLOS176D – FEBRUARY 1997 – REVISED MARCH 2001

electrical characteristics at specified free-air temperature, $V_{DD} = 5\text{ V}$ (unless otherwise noted)

| PARAMETER | TEST CONDITIONS | T_A † | TLC2254C | | | UNIT |
|----------------------------------------------------------------------------|--------------------------------------------------------------------------------------|------------------------------|------------|-------------|----------|------------------------------|
| | | | MIN | TYP | MAX | |
| V_{IO} Input offset voltage | $V_{IC} = 0,$ $V_O = 0,$ $V_{DD\pm} = \pm 2.5\text{ V},$ $R_S = 50\ \Omega$ | 25°C | 200 | 1500 | | μV |
| | | Full range | | 1750 | | |
| $\alpha_{V_{IO}}$ Temperature coefficient of input offset voltage | | 25°C to 70°C | 0.5 | | | $\mu\text{V}/^\circ\text{C}$ |
| Input offset voltage long-term drift (see Note 4) | | 25°C | 0.003 | | | $\mu\text{V}/\text{mo}$ |
| I_{IO} Input offset current | | 25°C | 0.5 | 60 | | pA |
| | | Full range | | 100 | | |
| I_{IB} Input bias current | | 25°C | 1 | 60 | | pA |
| | | Full range | | 100 | | |
| V_{ICR} Common-mode input voltage range | $R_S = 50\ \Omega,$ $ V_{IO} \leq 5\text{ mV}$ | 25°C | 0 to 4 | -0.3 to 4.2 | | V |
| | | Full range | 0 to 3.5 | | | |
| V_{OH} High-level output voltage | $I_{OH} = -20\ \mu\text{A}$ | 25°C | 4.9 | 4.98 | | V |
| | $I_{OH} = -75\ \mu\text{A}$ | 25°C | 4.9 | 4.94 | | |
| | Full range | | 4.8 | | | |
| V_{OL} Low-level output voltage | $V_{IC} = 2.5\text{ V},$ $I_{OL} = 50\ \mu\text{A}$ | 25°C | 0.01 | | | V |
| | $V_{IC} = 2.5\text{ V},$ $I_{OL} = 500\ \mu\text{A}$ | 25°C | 0.09 | 0.15 | | |
| | | Full range | | 0.15 | | |
| | $V_{IC} = 2.5\text{ V},$ $I_{OL} = 1\text{ mA}$ | 25°C | 0.2 | 0.3 | | |
| | | Full range | | 0.3 | | |
| | $V_{IC} = 2.5\text{ V},$ $I_{OL} = 4\text{ mA}$ | 25°C | 0.7 | 1 | | |
| Full range | | | 1.2 | | | |
| A_{VD} Large-signal differential voltage amplification | $V_{IC} = 2.5\text{ V},$ $V_O = 1\text{ V to }4\text{ V}$ | $R_L = 100\text{ k}\Omega$ ‡ | 25°C | 100 | 350 | V/mV |
| | | $R_L = 1\text{ M}\Omega$ ‡ | Full range | 10 | | |
| | | | 25°C | | 1700 | |
| $r_{i(d)}$ Differential input resistance | | 25°C | 10^{12} | | Ω | |
| $r_{i(c)}$ Common-mode input resistance | | 25°C | 10^{12} | | Ω | |
| $c_{i(c)}$ Common-mode input capacitance | $f = 10\text{ kHz},$ N package | 25°C | 8 | | pF | |
| z_o Closed-loop output impedance | $f = 25\text{ kHz},$ $A_V = 10$ | 25°C | 200 | | Ω | |
| CMRR Common-mode rejection ratio | $V_{IC} = 0\text{ to }2.7\text{ V},$ $V_O = 2.5\text{ V},$ $R_S = 50\ \Omega$ | 25°C | 70 | 83 | | dB |
| | | Full range | 70 | | | |
| k_{SVR} Supply-voltage rejection ratio ($\Delta V_{DD}/\Delta V_{IO}$) | $V_{DD} = 4.4\text{ V to }16\text{ V},$ $V_{IC} = V_{DD}/2,$ No load | 25°C | 80 | 95 | | dB |
| | | Full range | 80 | | | |
| I_{DD} Supply current (four amplifiers) | $V_O = 2.5\text{ V},$ No load | 25°C | 140 | 250 | | μA |
| | | Full range | | 300 | | |

† Full range is 0°C to 70°C.

‡ Referenced to 2.5 V

NOTE 4: Typical values are based on the input offset voltage shift observed through 500 hours of operating life test at $T_A = 150^\circ\text{C}$ extrapolated to $T_A = 25^\circ\text{C}$ using the Arrhenius equation and assuming an activation energy of 0.96 eV.



TLC225x, TLC225xA
Advanced LinCMOS™ RAIL-TO-RAIL
VERY LOW-POWER OPERATIONAL AMPLIFIERS

SLOS176D – FEBRUARY 1997 – REVISED MARCH 2001

operating characteristics at specified free-air temperature, $V_{DD} = 5\text{ V}$

| PARAMETER | | TEST CONDITIONS | | T_A † | TLC2254C | | | UNIT |
|-------------|---------------------------------------------|--------------------------------------------------------------------------------------------------|----------------------------------------|------------|------------|------|------------------------------|------|
| | | | | | MIN | TYP | MAX | |
| SR | Slew rate at unity gain | $V_O = 1.4\text{ V to }2.6\text{ V}$ $R_L = 100\text{ k}\Omega$ ‡, $C_L = 100\text{ pF}$ ‡ | | 25°C | 0.07 | 0.12 | $\text{V}/\mu\text{s}$ | |
| | | | | Full range | 0.05 | | | |
| V_n | Equivalent input noise voltage | | | 25°C | 36 | | $\text{nV}/\sqrt{\text{Hz}}$ | |
| | | | | 25°C | 19 | | | |
| $V_{N(PP)}$ | Peak-to-peak equivalent input noise voltage | | | 25°C | 0.7 | | μV | |
| | | | | 25°C | 1.1 | | | |
| I_n | Equivalent input noise current | | | 25°C | 0.6 | | $\text{fA}/\sqrt{\text{Hz}}$ | |
| THD + N | Total harmonic distortion plus noise | $V_O = 0.5\text{ V to }2.5\text{ V}$, $f = 10\text{ kHz}$, $R_L = 50\text{ k}\Omega$ ‡ | | 25°C | $A_V = 1$ | | | |
| | | | | | $A_V = 10$ | | | |
| | Gain-bandwidth product | $f = 10\text{ kHz}$, $C_L = 100\text{ pF}$ ‡ | $R_L = 50\text{ k}\Omega$ ‡, | 25°C | 0.2 | | MHz | |
| BOM | Maximum output-swing bandwidth | $V_{O(PP)} = 2\text{ V}$, $R_L = 50\text{ k}\Omega$ ‡, | $A_V = 1$, $C_L = 100\text{ pF}$ ‡ | 25°C | 30 | | kHz | |
| ϕ_m | Phase margin at unity gain | $R_L = 50\text{ k}\Omega$ ‡, | $C_L = 100\text{ pF}$ ‡ | 25°C | 63° | | | |
| | Gain margin | | | 25°C | 15 | | dB | |

† Full range is 0°C to 70°C.

‡ Referenced to 2.5 V

TLC225x, TLC225xA
Advanced LinCMOS™ RAIL-TO-RAIL
VERY LOW-POWER OPERATIONAL AMPLIFIERS

SLOS176D – FEBRUARY 1997 – REVISED MARCH 2001

electrical characteristics at specified free-air temperature, $V_{DD\pm} = \pm 5\text{ V}$ (unless otherwise specified)

| PARAMETER | TEST CONDITIONS | T _A † | TLC2254C | | | UNIT |
|----------------------------------------------------------------------------------------|----------------------------------------------------------------------------|----------------------------------------------|-------------------------|-------------|-------|------|
| | | | MIN | TYP | MAX | |
| V _{IO} Input offset voltage | V _{IC} = 0, V _O = 0, R _S = 50 Ω | 25°C | 200 | 1500 | μV | |
| | | Full range | 1750 | | | |
| α _{VIO} Temperature coefficient of input offset voltage | | 25°C to 70°C | 0.5 | | μV/°C | |
| Input offset voltage long-term drift (see Note 4) | | 25°C | 0.003 | | μV/mo | |
| I _{IO} Input offset current | | 25°C | 0.5 | 60 | pA | |
| | | Full range | 100 | | | |
| I _{IB} Input bias current | | 25°C | 1 | 60 | pA | |
| | | Full range | 100 | | | |
| V _{ICR} Common-mode input voltage range | V _{IO} ≤ 5 mV, R _S = 50 Ω | 25°C | -5 to 4 | -5.3 to 4.2 | V | |
| | | Full range | -5 to 3.5 | | | |
| V _{OM+} Maximum positive peak output voltage | I _O = -20 μA | 25°C | 4.98 | | V | |
| | I _O = -100 μA | 25°C | 4.9 | 4.93 | | |
| | | Full range | 4.7 | | | |
| | I _O = -200 μA | 25°C | 4.8 | 4.86 | | |
| V _{OM-} Maximum negative peak output voltage | V _{IC} = 0, I _O = 50 μA | 25°C | -4.99 | | V | |
| | | 25°C | -4.85 | -4.91 | | |
| | Full range | -4.85 | | | | |
| | | V _{IC} = 0, I _O = 500 μA | 25°C | -4.7 | | -4.8 |
| | Full range | | -4.7 | | | |
| | V _{IC} = 0, I _O = 1 mA | 25°C | -4 | -4.3 | | |
| | | Full range | -3.8 | | | |
| | A _{VD} Large-signal differential voltage amplification | V _O = ±4 V | R _L = 100 kΩ | 25°C | | 40 |
| Full range | | | | 10 | | |
| R _L = 1 MΩ | | | 25°C | 3000 | | |
| r _{i(d)} Differential input resistance | | 25°C | 10 ¹² | | Ω | |
| r _{i(c)} Common-mode input resistance | | 25°C | 10 ¹² | | Ω | |
| c _{i(c)} Common-mode input capacitance | f = 10 kHz, N package | 25°C | 8 | | pF | |
| z _O Closed-loop output impedance | f = 25 kHz, A _V = 10 | 25°C | 190 | | Ω | |
| CMRR Common-mode rejection ratio | V _{IC} = -5 V to 2.7 V, V _O = 0, R _S = 50 Ω | 25°C | 75 | 88 | dB | |
| | | Full range | 75 | | | |
| k _{SVR} Supply-voltage rejection ratio (ΔV _{DD±} /ΔV _{IO}) | V _{DD±} = ±2.2 V to ±8 V, V _{IC} = 0, No load | 25°C | 80 | 95 | dB | |
| | | Full range | 80 | | | |
| I _{DD} Supply current (four amplifiers) | V _O = 0, No load | 25°C | 160 | 250 | μA | |
| | | Full range | 300 | | | |

† Full range is 0°C to 70°C.

NOTE 4: Typical values are based on the input offset voltage shift observed through 500 hours of operating life test at T_A = 150°C extrapolated to T_A = 25°C using the Arrhenius equation and assuming an activation energy of 0.96 eV.



TLC225x, TLC225xA
Advanced LinCMOS™ RAIL-TO-RAIL
VERY LOW-POWER OPERATIONAL AMPLIFIERS

SLOS176D – FEBRUARY 1997 – REVISED MARCH 2001

operating characteristics at specified free-air temperature, $V_{DD\pm} = \pm 5\text{ V}$

| PARAMETER | | TEST CONDITIONS | | T_A † | TLC2254C | | | UNIT |
|-------------|---------------------------------------------|----------------------------------------------------------------------------------|--------------------------------------|------------|------------|------|------------------------------|------|
| | | | | | MIN | TYP | MAX | |
| SR | Slew rate at unity gain | $V_O = \pm 1.9\text{ V}$, $C_L = 100\text{ pF}$ | $R_L = 100\text{ k}\Omega$ | 25°C | 0.07 | 0.12 | $\text{V}/\mu\text{s}$ | |
| | | | | Full range | 0.05 | | | |
| V_n | Equivalent input noise voltage | | | 25°C | 38 | | $\text{nV}/\sqrt{\text{Hz}}$ | |
| | | | | 25°C | 19 | | | |
| $V_{N(PP)}$ | Peak-to-peak equivalent input noise voltage | | | 25°C | 0.8 | | μV | |
| | | | | 25°C | 1.1 | | | |
| I_n | Equivalent input noise current | | | 25°C | 0.6 | | $\text{fA}/\sqrt{\text{Hz}}$ | |
| THD + N | Total harmonic distortion plus noise | $V_O = \pm 2.3\text{ V}$, $f = 20\text{ kHz}$, $R_L = 50\text{ k}\Omega$ | | 25°C | $A_V = 1$ | | | |
| | | | | | $A_V = 10$ | | | |
| | Gain-bandwidth product | $f = 10\text{ kHz}$, $C_L = 100\text{ pF}$ | $R_L = 50\text{ k}\Omega$ | 25°C | 0.21 | | MHz | |
| B_{OM} | Maximum output-swing bandwidth | $V_{O(PP)} = 4.6\text{ V}$, $R_L = 50\text{ k}\Omega$ | $A_V = 1$, $C_L = 100\text{ pF}$ | 25°C | 14 | | kHz | |
| ϕ_m | Phase margin at unity gain | $R_L = 50\text{ k}\Omega$ | $C_L = 100\text{ pF}$ | 25°C | 63° | | | |
| | Gain margin | | | 25°C | 15 | | dB | |

† Full range is 0°C to 70°C.

TLC225x, TLC225xA
Advanced LinCMOS™ RAIL-TO-RAIL
VERY LOW-POWER OPERATIONAL AMPLIFIERS

SLOS176D – FEBRUARY 1997 – REVISED MARCH 2001

electrical characteristics at specified free-air temperature, $V_{DD} = 5\text{ V}$ (unless otherwise noted)

| PARAMETER | TEST CONDITIONS | T_A † | TLC2252I | | | TLC2252AI | | | UNIT | |
|-----------------------------------------------------------------------|------------------------------------------------------------------------------------|------------------------------|------------|-------------|------------|-------------|-----|-------------|------------------------------|------|
| | | | MIN | TYP | MAX | MIN | TYP | MAX | | |
| V_{IO} Input offset voltage | $V_{DD} \pm = \pm 2.5\text{ V}$, $V_O = 0$, $V_{IC} = 0$, $R_S = 50\ \Omega$ | 25°C | 200 | | 1500 | 200 | | 850 | μV | |
| | | Full range | 1750 | | | 1000 | | | | |
| α_{VIO} Temperature coefficient of input offset voltage | | 25°C to 85°C | 0.5 | | | 0.5 | | | $\mu\text{V}/^\circ\text{C}$ | |
| Input offset voltage long-term drift (see Note 4) | | 25°C | 0.003 | | | 0.003 | | | $\mu\text{V}/\text{mo}$ | |
| I_{IO} Input offset current | | 25°C | 0.5 | | 60 | 0.5 | | 60 | pA | |
| | | Full range | 1000 | | | 1000 | | | | |
| I_{IB} Input bias current | 25°C | 1 | | 60 | 1 | | 60 | pA | | |
| | Full range | 1000 | | | 1000 | | | | | |
| V_{ICR} Common-mode input voltage range | $R_S = 50\ \Omega$, $ V_{IO} \leq 5\text{ mV}$ | 25°C | 0 to 4 | -0.3 to 4.2 | 0 to 4 | -0.3 to 4.2 | | | V | |
| | | Full range | 3.5 to 3.5 | | 3.5 to 3.5 | | | | | |
| V_{OH} High-level output voltage | $I_{OH} = -20\ \mu\text{A}$ | 25°C | 4.98 | | 4.98 | | | | V | |
| | $I_{OH} = -75\ \mu\text{A}$ | 25°C | 4.9 | 4.94 | 4.9 | 4.94 | | | | |
| | $I_{OH} = -150\ \mu\text{A}$ | Full range | 4.8 | | 4.8 | | | | | |
| V_{OL} Low-level output voltage | $V_{IC} = 2.5\text{ V}$, $I_{OL} = 50\ \mu\text{A}$ | 25°C | 0.01 | | 0.01 | | | | V | |
| | $V_{IC} = 2.5\text{ V}$, $I_{OL} = 500\ \mu\text{A}$ | 25°C | 0.09 | 0.15 | 0.09 | 0.15 | | | | |
| | | Full range | 0.15 | | 0.15 | | | | | |
| | $V_{IC} = 2.5\text{ V}$, $I_{OL} = 4\text{ mA}$ | 25°C | 0.8 | 1 | 0.7 | 1 | | | | |
| Full range | | 1.2 | | 1.2 | | | | | | |
| A_{VD} Large-signal differential voltage amplification | $V_{IC} = 2.5\text{ V}$, $V_O = 1\text{ V to }4\text{ V}$ | $R_L = 100\text{ k}\Omega$ ‡ | 25°C | 100 | 350 | 100 | 350 | | | V/mV |
| | | | Full range | 10 | | 10 | | | | |
| | | $R_L = 1\text{ M}\Omega$ ‡ | 25°C | 1700 | | 1700 | | | | |
| r_{id} Differential input resistance | | 25°C | 10^{12} | | 10^{12} | | | | Ω | |
| r_{ic} Common-mode input resistance | | 25°C | 10^{12} | | 10^{12} | | | | Ω | |
| C_{ic} Common-mode input capacitance | $f = 10\text{ kHz}$, P package | 25°C | 8 | | 8 | | | | pF | |
| z_o Closed-loop output impedance | $f = 25\text{ kHz}$, $A_V = 10$ | 25°C | 200 | | 200 | | | | Ω | |
| CMRR Common-mode rejection ratio | $V_{IC} = 0\text{ to }2.7\text{ V}$, $V_O = 2.5\text{ V}$, $R_S = 50\ \Omega$ | 25°C | 70 | 83 | 70 | 83 | | | dB | |
| | | Full range | 70 | | 70 | | | | | |
| kSVR Supply-voltage rejection ratio ($\Delta V_{DD}/\Delta V_{IO}$) | $V_{DD} = 4.4\text{ V to }16\text{ V}$, $V_{IC} = V_{DD}/2$, No load | 25°C | 80 | 95 | 80 | 95 | | | dB | |
| | | Full range | 80 | | 80 | | | | | |
| I_{DD} Supply current | $V_O = 2.5\text{ V}$, No load | 25°C | 70 | 125 | 70 | 125 | | | μA | |
| | | Full range | 150 | | | 150 | | | | |

† Full range is -40°C to 125°C .

‡ Referenced to 2.5 V

NOTE 4: Typical values are based on the input offset voltage shift observed through 500 hours of operating life test at $T_A = 150^\circ\text{C}$ extrapolated to $T_A = 25^\circ\text{C}$ using the Arrhenius equation and assuming an activation energy of 0.96 eV.



TLC225x, TLC225xA
Advanced LinCMOS™ RAIL-TO-RAIL
VERY LOW-POWER OPERATIONAL AMPLIFIERS

SLOS176D – FEBRUARY 1997 – REVISED MARCH 2001

operating characteristics at specified free-air temperature, $V_{DD} = 5\text{ V}$

| PARAMETER | TEST CONDITIONS | | T_A † | TLC2252I | | | TLC2252AI | | | UNIT | |
|-------------|---------------------------------------------|----------------------------------------------------------------------------------------------|-------------------------------------|------------|------|-----|-----------|------|-----|------------------------|--|
| | | | | MIN | TYP | MAX | MIN | TYP | MAX | | |
| SR | Slew rate at unity gain | $V_O = 1.5\text{ V to }3.5\text{ V}$, $R_L = 100\text{ k}\Omega$ ‡, $C_L = 100\text{ pF}$ ‡ | 25°C | 0.07 | 0.12 | | 0.07 | 0.12 | | V/ μs | |
| | | | Full range | 0.05 | | | 0.05 | | | | |
| V_n | Equivalent input noise voltage | $f = 10\text{ Hz}$ | 25°C | 36 | | | 36 | | | nV/ $\sqrt{\text{Hz}}$ | |
| | | | $f = 1\text{ kHz}$ | 19 | | | 19 | | | | |
| $V_{N(PP)}$ | Peak-to-peak equivalent input noise voltage | $f = 0.1\text{ Hz to }10\text{ Hz}$ | 25°C | 0.7 | | | 0.7 | | | μV | |
| | | | $f = 0.1\text{ Hz to }10\text{ Hz}$ | 1.1 | | | 1.1 | | | | |
| I_n | Equivalent input noise current | | 25°C | 0.6 | | | 0.6 | | | fA/ $\sqrt{\text{Hz}}$ | |
| THD + N | Total harmonic distortion plus noise | $V_O = 0.5\text{ V to }2.5\text{ V}$, $f = 10\text{ kHz}$, $R_L = 50\text{ k}\Omega$ ‡ | 25°C | $A_V = 1$ | 0.2% | | | 0.2% | | | |
| | | | | $A_V = 10$ | 1% | | | 1% | | | |
| | Gain-bandwidth product | $f = 50\text{ kHz}$, $C_L = 100\text{ pF}$ ‡ | 25°C | 0.2 | | | 0.2 | | | MHz | |
| BOM | Maximum output-swing bandwidth | $V_{O(PP)} = 2\text{ V}$, $R_L = 50\text{ k}\Omega$ ‡ | 25°C | 30 | | | 30 | | | kHz | |
| ϕ_m | Phase margin at unity gain | $R_L = 50\text{ k}\Omega$ ‡, $C_L = 100\text{ pF}$ ‡ | 25°C | 63° | | | 63° | | | | |
| | | | 25°C | 15 | | | 15 | | | | |
| | Gain margin | | 25°C | 15 | | | 15 | | | dB | |

† Full range is –40°C to 125°C.

‡ Referenced to 2.5 V

TLC225x, TLC225xA
Advanced LinCMOS™ RAIL-TO-RAIL
VERY LOW-POWER OPERATIONAL AMPLIFIERS

SLOS176D – FEBRUARY 1997 – REVISED MARCH 2001

electrical characteristics at specified free-air temperature, $V_{DD\pm} = \pm 5$ V (unless otherwise noted)

| PARAMETER | TEST CONDITIONS | T_A † | TLC2252I | | | TLC2252AI | | | UNIT |
|---------------------------------------------------------------------------------|---------------------------------------------------------|--------------------|-------------------|------------------|------|-----------|------------------|------------------|--------|
| | | | MIN | TYP | MAX | MIN | TYP | MAX | |
| V_{IO} Input offset voltage | $V_{IC} = 0, V_O = 0, R_S = 50 \Omega$ | 25°C | 200 | 1500 | | 200 | 850 | μV | |
| | | Full range | | | 1750 | | 1000 | | |
| α_{VIO} Temperature coefficient of input offset voltage | | 25°C to 85°C | 0.5 | | | 0.5 | | $\mu V/^\circ C$ | |
| Input offset voltage long-term drift (see Note 4) | | 25°C | 0.003 | | | 0.003 | | $\mu V/mo$ | |
| I_{IO} Input offset current | | 25°C | 0.5 | 60 | | 0.5 | 60 | pA | |
| | | Full range | | | 1000 | | 1000 | | |
| I_{IB} Input bias current | 25°C | 1 | 60 | | 1 | 60 | pA | | |
| | Full range | | | 1000 | | 1000 | | | |
| V_{ICR} Common-mode input voltage range | $R_S = 50 \Omega, V_{IO} \leq 5 mV$ | 25°C | -5 to 4 | -5.3 to 4.2 | | -5 to 4 | -5.3 to 4.2 | V | |
| | | Full range | -5 to 3.5 | | | -5 to 3.5 | | | |
| V_{OM+} Maximum positive peak output voltage | $I_O = -20 \mu A$ | 25°C | | 4.98 | | 4.98 | V | | |
| | $I_O = -100 \mu A$ | 25°C | 4.9 | 4.93 | | 4.9 | | 4.93 | |
| | | Full range | | 4.7 | | | | 4.7 | |
| | $I_O = -200 \mu A$ | 25°C | 4.8 | 4.86 | | 4.8 | | 4.86 | |
| V_{OM-} Maximum negative peak output voltage | $V_{IC} = 0, I_O = 50 \mu A$ | 25°C | | -4.99 | | -4.99 | V | | |
| | $V_{IC} = 0, I_O = 500 \mu A$ | 25°C | -4.85 | -4.91 | | -4.85 | | -4.91 | |
| | | Full range | | -4.85 | | | | -4.85 | |
| | $V_{IC} = 0, I_O = 4 mA$ | 25°C | -4 | -4.3 | | -4 | | -4.3 | |
| AVD Large-signal differential voltage amplification | $V_O = \pm 4 V$ | $R_L = 50 k\Omega$ | 25°C | 40 | 150 | | 40 | 150 | V/mV |
| | | | Full range | | 10 | | | 10 | |
| | | | $R_L = 1 M\Omega$ | 25°C | | 3000 | | | |
| r_{id} Differential input resistance | | 25°C | | 10 ¹² | | | 10 ¹² | Ω | |
| r_{ic} Common-mode input resistance | | 25°C | | 10 ¹² | | | 10 ¹² | Ω | |
| C_{ic} Common-mode input capacitance | f = 10 kHz, P package | 25°C | | 8 | | | 8 | pF | |
| Z_o Closed-loop output impedance | f = 25 kHz, $A_V = 10$ | 25°C | | 190 | | | 190 | Ω | |
| CMRR Common-mode rejection ratio | $V_{IC} = -5 V$ to 2.7 V, $V_O = 0, R_S = 50 \Omega$ | 25°C | 75 | 88 | | 75 | 88 | dB | |
| | | Full range | | 75 | | | 75 | | |
| k_{SVR} Supply-voltage rejection ratio ($\Delta V_{DD\pm} / \Delta V_{IO}$) | $V_{DD} = 4.4 V$ to 16 V, $V_{IC} = V_{DD}/2$, No load | 25°C | 80 | 95 | | 80 | 95 | dB | |
| | | Full range | | 80 | | | 80 | | |
| I_{DD} Supply current | $V_O = 2.5 V$, No load | 25°C | 80 | 125 | | 80 | 125 | μA | |
| | | Full range | | 150 | | | 150 | | |

† Full range is -40°C to 125°C.

NOTE 4: Typical values are based on the input offset voltage shift observed through 500 hours of operating life test at $T_A = 150^\circ C$ extrapolated to $T_A = 25^\circ C$ using the Arrhenius equation and assuming an activation energy of 0.96 eV.



TLC225x, TLC225xA
Advanced LinCMOS™ RAIL-TO-RAIL
VERY LOW-POWER OPERATIONAL AMPLIFIERS

SLOS176D – FEBRUARY 1997 – REVISED MARCH 2001

operating characteristics at specified free-air temperature, $V_{DD\pm} = \pm 5\text{ V}$

| PARAMETER | TEST CONDITIONS | T_A † | TLC2252I | | | TLC2252AI | | | UNIT | |
|-------------|-------------------------------------------------------------------------------------------------------------|-----------------------------------------------------------------------------------------------|------------|------|-----|-----------|------|-----|------------------------|--|
| | | | MIN | TYP | MAX | MIN | TYP | MAX | | |
| SR | Slew rate at unity gain $V_O = \pm 1.9\text{ V}$, $R_L = 100\text{ k}\Omega$, $C_L = 100\text{ pF}$ | 25°C | 0.07 | 0.12 | | 0.07 | 0.12 | | V/ μs | |
| | | Full range | 0.05 | | | 0.05 | | | | |
| V_n | Equivalent input noise voltage | f = 10 Hz | 25°C | | | 38 | | | nV/ $\sqrt{\text{Hz}}$ | |
| | | f = 1 kHz | 25°C | | | 19 | | | | |
| $V_{N(PP)}$ | Peak-to-peak equivalent input noise voltage | f = 0.1 Hz to 1 Hz | 25°C | | | 0.8 | | | μV | |
| | | f = 0.1 Hz to 10 Hz | 25°C | | | 1.1 | | | | |
| I_n | Equivalent input noise current | 25°C | 0.6 | | | 0.6 | | | fA/ $\sqrt{\text{Hz}}$ | |
| THD + N | Total harmonic distortion plus noise | $V_O = \pm 2.3\text{ V}$, $R_L = 50\text{ k}\Omega$, f = 10 kHz | $A_V = 1$ | 25°C | | | 0.2% | | | |
| | | | $A_V = 10$ | 25°C | | | 1% | | | |
| | Gain-bandwidth product | f = 10 kHz, $C_L = 100\text{ pF}$, $R_L = 50\text{ k}\Omega$ | 25°C | | | 0.21 | | | MHz | |
| BOM | Maximum output-swing bandwidth | $V_{O(PP)} = 4.6\text{ V}$, $A_V = 1$, $R_L = 50\text{ k}\Omega$, $C_L = 100\text{ pF}$ | 25°C | | | 14 | | | kHz | |
| ϕ_m | Phase margin at unity gain | $R_L = 50\text{ k}\Omega$, $C_L = 100\text{ pF}$ | 25°C | | | 63° | | | | |
| | Gain margin | | 25°C | | | 15 | | | dB | |

† Full range is -40°C to 125°C .

TLC225x, TLC225xA
Advanced LinCMOS™ RAIL-TO-RAIL
VERY LOW-POWER OPERATIONAL AMPLIFIERS

SLOS176D – FEBRUARY 1997 – REVISED MARCH 2001

electrical characteristics at specified free-air temperature, $V_{DD} = 5\text{ V}$ (unless otherwise noted)

| PARAMETER | TEST CONDITIONS | T_A † | TLC2254I | | | TLC2254AI | | | UNIT | |
|----------------------------------------------------------------------------|--------------------------------------------------------------------------------------|--------------------------------------------------|------------|-------------|----------|-----------|-------------|------|------------------------------|------|
| | | | MIN | TYP | MAX | MIN | TYP | MAX | | |
| V_{IO} Input offset voltage | | 25°C | 200 | | 1500 | 200 | | 850 | μV | |
| | | Full range | | | 1750 | | | 1000 | | |
| α_{VIO} Temperature coefficient of input offset voltage | $V_{DD} = \pm 2.5\text{ V}$, $V_{IC} = 0$, $V_O = 0$, $R_S = 50\ \Omega$ | 25°C to 125°C | 0.5 | | | 0.5 | | | $\mu\text{V}/^\circ\text{C}$ | |
| Input offset voltage long-term drift (see Note 4) | | 25°C | 0.003 | | | 0.003 | | | $\mu\text{V}/\text{mo}$ | |
| I_{IO} Input offset current | | 25°C | 0.5 | 60 | | 0.5 | 60 | | pA | |
| | | Full range | | | 1000 | | | 1000 | | |
| I_{IB} Input bias current | 25°C | 1 | | 60 | 1 | | 60 | pA | | |
| | Full range | | | 1000 | | | 1000 | | | |
| V_{ICR} Common-mode input voltage range | $R_S = 50\ \Omega$, $ V_{IO} \leq 5\text{ mV}$ | 25°C | 0 to 4 | -0.3 to 4.2 | | 0 to 4 | -0.3 to 4.2 | V | | |
| | | Full range | 0 to 3.5 | | 0 to 3.5 | | | | | |
| V_{OH} High-level output voltage | $I_{OH} = -20\ \mu\text{A}$ | 25°C | 4.98 | | | 4.98 | | | V | |
| | | 25°C | 4.9 | 4.94 | | 4.9 | 4.94 | | | |
| | | Full range | 4.8 | | | 4.8 | | | | |
| V_{OL} Low-level output voltage | $V_{IC} = 2.5\text{ V}$, $I_{OL} = 50\ \mu\text{A}$ | 25°C | 0.01 | | | 0.01 | | | V | |
| | | 25°C | 0.09 | 0.15 | | 0.09 | 0.15 | | | |
| | Full range | 0.15 | | | 0.15 | | | | | |
| | | $V_{IC} = 2.5\text{ V}$, $I_{OL} = 4\text{ mA}$ | 25°C | 0.8 | 1 | | 0.7 | 1 | | |
| Full range | | | 1.2 | | | 1.2 | | | | |
| A_{VD} Large-signal differential voltage amplification | $V_{IC} = 2.5\text{ V}$, $V_O = 1\text{ V to }4\text{ V}$ | $R_L = 100\text{ k}\Omega$ ‡ | 25°C | 100 | 350 | | 100 | 350 | | V/mV |
| | | | Full range | 10 | | | 10 | | | |
| | | $R_L = 1\text{ M}\Omega$ ‡ | 25°C | 1700 | | | 1700 | | | |
| $r_{i(d)}$ Differential input resistance | | 25°C | 10^{12} | | | 10^{12} | | | Ω | |
| $r_{i(c)}$ Common-mode input resistance | | 25°C | 10^{12} | | | 10^{12} | | | Ω | |
| $C_{i(c)}$ Common-mode input capacitance | $f = 10\text{ kHz}$, N package | 25°C | 8 | | | 8 | | | pF | |
| z_o Closed-loop output impedance | $f = 25\text{ kHz}$, $A_V = 10$ | 25°C | 200 | | | 200 | | | Ω | |
| CMRR Common-mode rejection ratio | $V_{IC} = 0\text{ to }2.7\text{ V}$, $V_O = 2.5\text{ V}$, $R_S = 50\ \Omega$ | 25°C | 70 | 83 | | 70 | 83 | | dB | |
| | | Full range | 70 | | | 70 | | | | |
| k_{SVR} Supply-voltage rejection ratio ($\Delta V_{DD}/\Delta V_{IO}$) | $V_{DD} = 4.4\text{ V to }16\text{ V}$, $V_{IC} = V_{DD}/2$, No load | 25°C | 80 | 95 | | 80 | 95 | | dB | |
| | | Full range | 80 | | | 80 | | | | |
| I_{DD} Supply current (four amplifiers) | $V_O = 2.5\text{ V}$, No load | 25°C | 140 | 250 | | 140 | 250 | | μA | |
| | | Full range | | | 300 | | | 300 | | |

† Full range is -40°C to 125°C .

‡ Referenced to 2.5 V

NOTE 4: Typical values are based on the input offset voltage shift observed through 500 hours of operating life test at $T_A = 150^\circ\text{C}$ extrapolated to $T_A = 25^\circ\text{C}$ using the Arrhenius equation and assuming an activation energy of 0.96 eV.



TLC225x, TLC225xA
Advanced LinCMOS™ RAIL-TO-RAIL
VERY LOW-POWER OPERATIONAL AMPLIFIERS

SLOS176D – FEBRUARY 1997 – REVISED MARCH 2001

operating characteristics at specified free-air temperature, $V_{DD} = 5\text{ V}$

| PARAMETER | TEST CONDITIONS | T_A † | TLC2254I | | | TLC2254AI | | | UNIT |
|-------------|----------------------------------------------------------------------------------------------------------------------------------------|------------|----------------------------------------|------|-----|-----------|------|-----|------------------------|
| | | | MIN | TYP | MAX | MIN | TYP | MAX | |
| SR | Slew rate at unity gain $V_O = 1.4\text{ V to }2.6\text{ V}$, $R_L = 100\text{ k}\Omega$ ‡, $C_L = 100\text{ pF}$ ‡ | 25°C | 0.07 | 0.12 | | 0.07 | 0.12 | | V/ μs |
| | | Full range | 0.05 | | | 0.05 | | | |
| V_n | Equivalent input noise voltage $f = 10\text{ Hz}$ $f = 1\text{ kHz}$ | 25°C | 36 | | | 36 | | | nV/ $\sqrt{\text{Hz}}$ |
| | | 25°C | 19 | | | 19 | | | |
| $V_{N(PP)}$ | Peak-to-peak equivalent input noise voltage $f = 0.1\text{ Hz to }1\text{ Hz}$ $f = 0.1\text{ Hz to }10\text{ Hz}$ | 25°C | 0.7 | | | 0.7 | | | μV |
| | | 25°C | 1.1 | | | 1.1 | | | |
| I_n | Equivalent input noise current | 25°C | 0.6 | | | 0.6 | | | fA/ $\sqrt{\text{Hz}}$ |
| THD + N | Total harmonic distortion plus noise $V_O = 0.5\text{ V to }2.5\text{ V}$, $f = 20\text{ kHz}$, $R_L = 50\text{ k}\Omega$ ‡ | 25°C | $A_V = 1$ | | | 0.2% | | | |
| | | | $A_V = 10$ | | | 1% | | | |
| | Gain-bandwidth product $f = 50\text{ kHz}$, $C_L = 100\text{ pF}$ ‡ | 25°C | $R_L = 50\text{ k}\Omega$ ‡ | | | 0.2 | | | MHz |
| BOM | Maximum output-swing bandwidth $V_{O(PP)} = 2\text{ V}$, $R_L = 50\text{ k}\Omega$ ‡ | 25°C | $A_V = 1$, $C_L = 100\text{ pF}$ ‡ | | | 30 | | | kHz |
| ϕ_m | Phase margin at unity gain $R_L = 50\text{ k}\Omega$ ‡ | 25°C | $C_L = 100\text{ pF}$ ‡ | | | 63° | | | |
| | Gain margin | 25°C | | | | 15 | | | dB |

† Full range is –40°C to 125°C.

‡ Referenced to 2.5 V

TLC225x, TLC225xA
Advanced LinCMOS™ RAIL-TO-RAIL
VERY LOW-POWER OPERATIONAL AMPLIFIERS

SLOS176D – FEBRUARY 1997 – REVISED MARCH 2001

electrical characteristics at specified free-air temperature, $V_{DD\pm} = \pm 5$ V (unless otherwise noted)

| PARAMETER | TEST CONDITIONS | T_A † | TLC2254I | | | TLC2254AI | | | UNIT |
|-------------------------------------------------------------------------------|---------------------------------------------------------------------|------------------------|------------|-------------|------|-----------|-------------|------------------|------|
| | | | MIN | TYP | MAX | MIN | TYP | MAX | |
| V_{IO} Input offset voltage | $V_{IC} = 0, V_O = 0, R_S = 50 \Omega$ | 25°C | 200 | 1500 | | 200 | 850 | μV | |
| | | Full range | | | 1750 | | 1000 | | |
| α_{VIO} Temperature coefficient of input offset voltage | | 25°C to 125°C | 0.5 | | | 0.5 | | $\mu V/^\circ C$ | |
| Input offset voltage long-term drift (see Note 4) | | 25°C | 0.003 | | | 0.003 | | $\mu V/mo$ | |
| I_{IO} Input offset current | | 25°C | 0.5 | 60 | | 0.5 | 60 | pA | |
| | | Full range | | | 1000 | | 1000 | | |
| I_{IB} Input bias current | 25°C | 1 | 60 | | 1 | 60 | pA | | |
| | Full range | | | 1000 | | 1000 | | | |
| V_{ICR} Common-mode input voltage range | $R_S = 50 \Omega, V_{IO} \leq 5$ mV | 25°C | -5 to 4 | -5.3 to 4.2 | | -5 to 4 | -5.3 to 4.2 | V | |
| | | Full range | -5 to 3.5 | | | -5 to 3.5 | | | |
| V_{OM+} Maximum positive peak output voltage | $I_O = -20 \mu A$ | 25°C | 4.98 | | | 4.98 | V | | |
| | $I_O = -100 \mu A$ | 25°C | 4.9 | 4.93 | | 4.9 | | 4.93 | |
| | | Full range | 4.7 | | | 4.7 | | | |
| | $I_O = -200 \mu A$ | 25°C | 4.8 | 4.86 | | 4.8 | | 4.86 | |
| V_{OM-} Maximum negative peak output voltage | $V_{IC} = 0, I_O = 50 \mu A$ | 25°C | -4.99 | | | -4.99 | V | | |
| | $V_{IC} = 0, I_O = 500 \mu A$ | 25°C | -4.85 | -4.91 | | -4.85 | | -4.91 | |
| | | Full range | -4.85 | | | -4.85 | | | |
| | $V_{IC} = 0, I_O = 4$ mA | 25°C | -4 | -4.3 | | -4 | | -4.3 | |
| A_{VD} Large-signal differential voltage amplification | $V_O = \pm 4$ V | $R_L = 100$ k Ω | 25°C | 40 | 150 | | 40 | 150 | V/mV |
| | | | Full range | 10 | | | 10 | | |
| | | $R_L = 1$ M Ω | 25°C | 3000 | | | 3000 | | |
| $r_{i(d)}$ Differential input resistance | | 25°C | 10^{12} | | | 10^{12} | Ω | | |
| $r_{i(c)}$ Common-mode input resistance | | 25°C | 10^{12} | | | 10^{12} | Ω | | |
| $C_{i(c)}$ Common-mode input capacitance | $f = 10$ kHz, N package | 25°C | 8 | | | 8 | pF | | |
| z_o Closed-loop output impedance | $f = 25$ kHz, $A_V = 10$ | 25°C | 190 | | | 190 | Ω | | |
| CMRR Common-mode rejection ratio | $V_{IC} = -5$ V to 2.7 V, $V_O = 0, R_S = 50 \Omega$ | 25°C | 75 | 88 | | 75 | 88 | dB | |
| | | Full range | 75 | | | 75 | | | |
| k_{SVR} Supply-voltage rejection ratio ($\Delta V_{DD\pm}/\Delta V_{IO}$) | $V_{DD\pm} = \pm 2.2$ V to ± 8 V, $V_{IC} = V_{DD}/2$, No load | 25°C | 80 | 95 | | 80 | 95 | dB | |
| | | Full range | 80 | | | 80 | | | |
| I_{DD} Supply current (four amplifiers) | $V_O = 0$, No load | 25°C | 160 | 250 | | 160 | 250 | μA | |
| | | Full range | | | 300 | | 300 | | |

† Full range is -40°C to 125°C.

NOTE 4: Typical values are based on the input offset voltage shift observed through 500 hours of operating life test at $T_A = 150^\circ C$ extrapolated to $T_A = 25^\circ C$ using the Arrhenius equation and assuming an activation energy of 0.96 eV.



TLC225x, TLC225xA
Advanced LinCMOS™ RAIL-TO-RAIL
VERY LOW-POWER OPERATIONAL AMPLIFIERS

SLOS176D – FEBRUARY 1997 – REVISED MARCH 2001

operating characteristics at specified free-air temperature, $V_{DD\pm} = \pm 5\text{ V}$

| PARAMETER | TEST CONDITIONS | T_A † | TLC2254I | | | TLC2254AI | | | UNIT |
|-------------|---------------------------------------------------------------------------------------------------------------------------------------|------------|----------|------|-----|-----------|------|-----|------------------------|
| | | | MIN | TYP | MAX | MIN | TYP | MAX | |
| SR | Slew rate at unity gain $V_O = \pm 1.9\text{ V}$, $C_L = 100\text{ pF}$, $R_L = 100\text{ k}\Omega$ | 25°C | 0.07 | 0.12 | | 0.07 | 0.12 | | V/ μs |
| | | Full range | 0.05 | | | 0.05 | | | |
| V_n | Equivalent input noise voltage | 25°C | 38 | | | 38 | | | nV/ $\sqrt{\text{Hz}}$ |
| | | 25°C | 19 | | | 19 | | | |
| $V_{N(PP)}$ | Peak-to-peak equivalent input noise voltage | 25°C | 0.8 | | | 0.8 | | | μV |
| | | 25°C | 1.1 | | | 1.1 | | | |
| I_n | Equivalent input noise current | 25°C | 0.6 | | | 0.6 | | | fA/ $\sqrt{\text{Hz}}$ |
| THD + N | Total harmonic distortion plus noise $V_O = \pm 2.3\text{ V}$, $R_L = 50\text{ k}\Omega$, $f = 20\text{ kHz}$ | 25°C | 0.2% | | | 0.2% | | | |
| | | | 1% | | | 1% | | | |
| | Gain-bandwidth product $f = 10\text{ kHz}$, $C_L = 100\text{ pF}$, $R_L = 50\text{ k}\Omega$ | 25°C | 0.21 | | | 0.21 | | | MHz |
| BOM | Maximum output-swing bandwidth $V_{O(PP)} = 4.6\text{ V}$, $R_L = 50\text{ k}\Omega$, $A_V = 1$, $C_L = 100\text{ pF}$ | 25°C | 14 | | | 14 | | | kHz |
| ϕ_m | Phase margin at unity gain $R_L = 50\text{ k}\Omega$, $C_L = 100\text{ pF}$ | 25°C | 63° | | | 63° | | | |
| | | 25°C | 15 | | | 15 | | | |

† Full range is -40°C to 125°C .

TLC225x, TLC225xA Advanced LinCMOS™ RAIL-TO-RAIL VERY LOW-POWER OPERATIONAL AMPLIFIERS

SLOS176D – FEBRUARY 1997 – REVISED MARCH 2001

electrical characteristics at specified free-air temperature, $V_{DD} = 5\text{ V}$ (unless otherwise noted)

| PARAMETER | TEST CONDITIONS | T_A † | TLC2252Q TLC2252M | | | TLC2252AQ TLC2252AM | | | UNIT | |
|----------------------------------------------------------------------------|------------------------------------------------------------------------------------------------------------------|------------------------------|----------------------|-------------|----------|------------------------|-------------|---------------|------------------------------|------|
| | | | MIN | TYP | MAX | MIN | TYP | MAX | | |
| V_{IO} Input offset voltage | $V_{DD\pm} = \pm 2.5\text{ V}$, $V_O = 0$, $V_{IC} = 0$, $R_S = 50\ \Omega$ | 25°C | 200 | 1500 | | 200 | 850 | μV | | |
| | | Full range | | | 1750 | | 1000 | | | |
| α_{VIO} Temperature coefficient of input offset voltage | | 25°C to 125°C | 0.5 | | | 0.5 | | | $\mu\text{V}/^\circ\text{C}$ | |
| Input offset voltage long-term drift (see Note 4) | | 25°C | 0.003 | | | 0.003 | | | $\mu\text{V}/\text{mo}$ | |
| I_{IO} Input offset current | | 25°C | 0.5 | 60 | | 0.5 | 60 | pA | | |
| | | Full range | | | 1000 | | 1000 | | | |
| I_{IB} Input bias current | 25°C | 1 | 60 | | 1 | 60 | pA | | | |
| | Full range | | | 1000 | | 1000 | | | | |
| V_{ICR} Common-mode input voltage range | $R_S = 50\ \Omega$, $ V_{IO} \leq 5\text{ mV}$ | 25°C | 0 to 4 | -0.3 to 4.2 | | 0 to 4 | -0.3 to 4.2 | V | | |
| | | Full range | 0 to 3.5 | | 0 to 3.5 | | | | | |
| V_{OH} High-level output voltage | $I_{OH} = -20\ \mu\text{A}$ $I_{OH} = -75\ \mu\text{A}$ $I_{OH} = -150\ \mu\text{A}$ | 25°C | 4.98 | | | 4.98 | | | V | |
| | | 25°C | 4.9 | 4.94 | | 4.9 | 4.94 | | | |
| | | Full range | 4.8 | | | 4.8 | | | | |
| | | 25°C | 4.8 | 4.88 | | 4.8 | 4.88 | | | |
| V_{OL} Low-level output voltage | $V_{IC} = 2.5\text{ V}$, $I_{OL} = 50\ \mu\text{A}$ $I_{OL} = 500\ \mu\text{A}$ $I_{OL} = 4\text{ mA}$ | 25°C | 0.01 | | | 0.01 | | | V | |
| | | 25°C | 0.09 | 0.15 | | 0.09 | 0.15 | | | |
| | | Full range | 0.15 | | | 0.15 | | | | |
| | | 25°C | 0.8 | 1 | | 0.7 | 1 | | | |
| | | Full range | 1.2 | | | 1.2 | | | | |
| | | 25°C | 100 | 350 | | 100 | 350 | | | |
| AVD Large-signal differential voltage amplification | $V_{IC} = 2.5\text{ V}$, $V_O = 1\text{ V to }4\text{ V}$ | $R_L = 100\text{ k}\Omega$ ‡ | 25°C | 100 | | | 100 | | | V/mV |
| | | | Full range | 10 | | | 10 | | | |
| | | $R_L = 1\text{ M}\Omega$ ‡ | 25°C | 1700 | | | 1700 | | | |
| r_{id} Differential input resistance | | 25°C | 10^{12} | | | 10^{12} | | | Ω | |
| r_{ic} Common-mode input resistance | | 25°C | 10^{12} | | | 10^{12} | | | Ω | |
| c_{ic} Common-mode input capacitance | $f = 10\text{ kHz}$, $f = 10\text{ kHz}$ | 25°C | 8 | | | 8 | | | pF | |
| z_o Closed-loop output impedance | $f = 25\text{ kHz}$, $A_V = 10$ | 25°C | 200 | | | 200 | | | Ω | |
| CMRR Common-mode rejection ratio | $V_{IC} = 0\text{ to }2.7\text{ V}$, $R_S = 50\ \Omega$, $V_O = 2.5\text{ V}$ | 25°C | 70 | 83 | | 70 | 83 | dB | | |
| | | Full range | 70 | | | 70 | | | | |
| k_{SVR} Supply-voltage rejection ratio ($\Delta V_{DD}/\Delta V_{IO}$) | $V_{DD} = 4.4\text{ V to }16\text{ V}$, $V_{IC} = V_{DD}/2$, No load | 25°C | 80 | 95 | | 80 | 95 | dB | | |
| | | Full range | 80 | | | 80 | | | | |
| I_{DD} Supply current | $V_O = 2.5\text{ V}$, No load | 25°C | 70 | 125 | | 70 | 125 | μA | | |
| | | Full range | 150 | | | 150 | | | | |

† Full range is -40°C to 125°C for Q suffix, -55°C to 125°C for M suffix.

‡ Referenced to 2.5 V

NOTE 4: Typical values are based on the input offset voltage shift observed through 500 hours of operating life test at $T_A = 150^\circ\text{C}$ extrapolated to $T_A = 25^\circ\text{C}$ using the Arrhenius equation and assuming an activation energy of 0.96 eV.



TLC225x, TLC225xA
Advanced LinCMOS™ RAIL-TO-RAIL
VERY LOW-POWER OPERATIONAL AMPLIFIERS

SLOS176D – FEBRUARY 1997 – REVISED MARCH 2001

operating characteristics at specified free-air temperature, $V_{DD} = 5\text{ V}$

| PARAMETER | TEST CONDITIONS | T_A † | TLC2252Q TLC2252M | | | TLC2252AQ TLC2252AM | | | UNIT | |
|-------------|----------------------------------------------------------------------------------------------------------------------------------------|----------------------------------------|----------------------|------|-----|------------------------|------|-----|------------------------|-----|
| | | | MIN | TYP | MAX | MIN | TYP | MAX | | |
| SR | Slew rate at unity gain $V_O = 0.5\text{ V to }3.5\text{ V}$, $R_L = 100\text{ k}\Omega$ ‡, $C_L = 100\text{ pF}$ ‡ | 25°C | 0.07 | 0.12 | | 0.07 | 0.12 | | V/ μs | |
| | | Full range | 0.05 | | | 0.05 | | | | |
| V_n | Equivalent input noise voltage $f = 10\text{ Hz}$ $f = 1\text{ kHz}$ | 25°C | | 36 | | | 36 | | nV/ $\sqrt{\text{Hz}}$ | |
| | | 25°C | | 19 | | | 19 | | | |
| $V_{N(PP)}$ | Peak-to-peak equivalent input noise voltage $f = 0.1\text{ Hz to }1\text{ Hz}$ $f = 0.1\text{ Hz to }10\text{ Hz}$ | 25°C | | 0.7 | | | 0.7 | | μV | |
| | | 25°C | | 1.1 | | | 1.1 | | | |
| I_n | Equivalent input noise current | 25°C | | 0.6 | | | 0.6 | | fA/ $\sqrt{\text{Hz}}$ | |
| THD + N | Total harmonic distortion plus noise $V_O = 0.5\text{ V to }2.5\text{ V}$, $f = 10\text{ kHz}$, $R_L = 50\text{ k}\Omega$ ‡ | $A_V = 1$ | 25°C | 0.2% | | | 0.2% | | | |
| | | $A_V = 10$ | | 1% | | | 1% | | | |
| | Gain-bandwidth product $f = 50\text{ kHz}$, $C_L = 100\text{ pF}$ ‡ | $R_L = 50\text{ k}\Omega$ ‡ | 25°C | 0.2 | | | 0.2 | | | MHz |
| B_{OM} | Maximum output-swing bandwidth $V_{O(PP)} = 2\text{ V}$, $R_L = 50\text{ k}\Omega$ ‡ | $A_V = 1$, $C_L = 100\text{ pF}$ ‡ | 25°C | 30 | | | 30 | | | kHz |
| ϕ_m | Phase margin at unity gain $R_L = 50\text{ k}\Omega$ ‡, $C_L = 100\text{ pF}$ ‡ | 25°C | 63° | | | 63° | | | | |
| | | 25°C | 15 | | | 15 | | | dB | |

† Full range is – 40°C to 125°C for Q suffix, – 55°C to 125°C for M suffix.

‡ Referenced to 2.5 V

TLC225x, TLC225xA
Advanced LinCMOS™ RAIL-TO-RAIL
VERY LOW-POWER OPERATIONAL AMPLIFIERS

SLOS176D – FEBRUARY 1997 – REVISED MARCH 2001

electrical characteristics at specified free-air temperature, $V_{DD\pm} = \pm 5$ V (unless otherwise noted)

| PARAMETER | TEST CONDITIONS | T_A † | TLC2252Q TLC2252M | | | TLC2252AQ TLC2252AM | | | UNIT |
|---------------------------------------------------------------------------------|--------------------------------------------------------|---------------------|----------------------|-------------|------|------------------------|-------------|------------------|------|
| | | | MIN | TYP | MAX | MIN | TYP | MAX | |
| V_{IO} Input offset voltage | $V_{IC} = 0, V_O = 0, R_S = 50 \Omega$ | 25°C | 200 | 1500 | | 200 | 850 | μV | |
| | | Full range | | | 1750 | | 1000 | | |
| αV_{IO} Temperature coefficient of input offset voltage | | 25°C to 125°C | 0.5 | | | 0.5 | | $\mu V/^\circ C$ | |
| Input offset voltage long-term drift (see Note 4) | | 25°C | 0.003 | | | 0.003 | | $\mu V/mo$ | |
| I_{IO} Input offset current | | 25°C | 0.5 | 60 | | 0.5 | 60 | pA | |
| | | Full range | | | 1000 | | 1000 | | |
| I_{IB} Input bias current | 25°C | 1 | 60 | | 1 | 60 | pA | | |
| | Full range | | | 1000 | | 1000 | | | |
| V_{ICR} Common-mode input voltage range | $R_S = 50 \Omega, V_{IO} \leq 5 mV$ | 25°C | -5 to 4 | -5.3 to 4.2 | | -5 to 4 | -5.3 to 4.2 | V | |
| | | Full range | -5 to 3.5 | | | -5 to 3.5 | | | |
| V_{OM+} Maximum positive peak output voltage | $I_O = -20 \mu A$ | 25°C | 4.98 | | | 4.98 | V | | |
| | $I_O = -100 \mu A$ | 25°C | 4.9 | 4.93 | | 4.9 | | 4.93 | |
| | | Full range | 4.7 | | | 4.7 | | | |
| | $I_O = -200 \mu A$ | 25°C | 4.8 | 4.86 | | 4.8 | | 4.86 | |
| V_{OM-} Maximum negative peak output voltage | $V_{IC} = 0, I_O = 50 \mu A$ | 25°C | -4.99 | | | -4.99 | V | | |
| | $V_{IC} = 0, I_O = 500 \mu A$ | 25°C | -4.85 | -4.91 | | -4.85 | | -4.91 | |
| | | Full range | -4.85 | | | -4.85 | | | |
| | $V_{IC} = 0, I_O = 4 mA$ | 25°C | -4 | -4.3 | | -4 | | -4.3 | |
| | | Full range | -3.8 | | | -3.8 | | | |
| AVD Large-signal differential voltage amplification | $V_O = \pm 4 V$ | $R_L = 100 k\Omega$ | 25°C | 40 | 150 | | 40 | 150 | V/mV |
| | | | Full range | 10 | | | 10 | | |
| | | $R_L = 1 M\Omega$ | 25°C | 3000 | | | 3000 | | |
| r_{id} Differential input resistance | | 25°C | 10^{12} | | | 10^{12} | Ω | | |
| r_{ic} Common-mode input resistance | | 25°C | 10^{12} | | | 10^{12} | Ω | | |
| c_{ic} Common-mode input capacitance | $f = 10 kHz, P$ package | 25°C | 8 | | | 8 | pF | | |
| z_o Closed-loop output impedance | $f = 25 kHz, A_V = 10$ | 25°C | 190 | | | 190 | Ω | | |
| CMRR Common-mode rejection ratio | $V_{IC} = -5 V$ to 2.7 V, $V_O = 0, R_S = 50 \Omega$ | 25°C | 75 | 88 | | 75 | 88 | dB | |
| | | Full range | 75 | | | 75 | | | |
| k_{SVR} Supply-voltage rejection ratio ($\Delta V_{DD\pm} / \Delta V_{IO}$) | $V_{DD} = \pm 2.2 V$ to $\pm 8 V, V_{IC} = 0, No load$ | 25°C | 80 | 95 | | 80 | 95 | dB | |
| | | Full range | 80 | | | 80 | | | |
| I_{DD} Supply current | $V_O = 2.5 V, No load$ | 25°C | 80 | 125 | | 80 | 125 | μA | |
| | | Full range | | | 150 | | 150 | | |

† Full range is -40°C to 125°C for Q suffix, -55°C to 125°C for M suffix.

NOTE 4: Typical values are based on the input offset voltage shift observed through 500 hours of operating life test at $T_A = 150^\circ C$ extrapolated to $T_A = 25^\circ C$ using the Arrhenius equation and assuming an activation energy of 0.96 eV.



TLC225x, TLC225xA
Advanced LinCMOS™ RAIL-TO-RAIL
VERY LOW-POWER OPERATIONAL AMPLIFIERS

SLOS176D – FEBRUARY 1997 – REVISED MARCH 2001

operating characteristics at specified free-air temperature, $V_{DD\pm} = \pm 5\text{ V}$

| PARAMETER | TEST CONDITIONS | T_A † | TLC2252Q TLC2252M | | | TLC2252AQ TLC2252AM | | | UNIT |
|-------------|---------------------------------------------------------------------------------------------------------------------------------------|------------|----------------------|------|-----|------------------------|------|------------------------------|------------------------------|
| | | | MIN | TYP | MAX | MIN | TYP | MAX | |
| SR | Slew rate at unity gain $V_O = \pm 2\text{ V}$, $C_L = 100\text{ pF}$, $R_L = 100\text{ k}\Omega$ | 25°C | 0.07 | 0.12 | | 0.07 | 0.12 | | $\text{V}/\mu\text{s}$ |
| | | Full range | 0.05 | | | 0.05 | | | |
| V_n | Equivalent input noise voltage | 25°C | | 38 | | | 38 | | $\text{nV}/\sqrt{\text{Hz}}$ |
| | | 25°C | | 19 | | | 19 | | |
| $V_{N(PP)}$ | Peak-to-peak equivalent input noise voltage | 25°C | | 0.8 | | | 0.8 | | μV |
| | | 25°C | | 1.1 | | | 1.1 | | |
| I_n | Equivalent input noise current | 25°C | | 0.6 | | | 0.6 | $\text{fA}/\sqrt{\text{Hz}}$ | |
| THD + N | Total harmonic distortion plus noise $V_O = \pm 2.3\text{ V}$, $R_L = 50\text{ k}\Omega$, $f = 10\text{ kHz}$ | 25°C | | 0.2% | | | 0.2% | | |
| | | 25°C | | 1% | | | 1% | | |
| | Gain-bandwidth product $f = 10\text{ kHz}$, $C_L = 100\text{ pF}$, $R_L = 50\text{ k}\Omega$ | 25°C | | 0.21 | | | 0.21 | MHz | |
| BOM | Maximum output-swing bandwidth $V_{O(PP)} = 4.6\text{ V}$, $R_L = 50\text{ k}\Omega$, $A_V = 1$, $C_L = 100\text{ pF}$ | 25°C | | 14 | | | 14 | kHz | |
| ϕ_m | Phase margin at unity gain $R_L = 50\text{ k}\Omega$, $C_L = 100\text{ pF}$ | 25°C | | 63° | | | 63° | | |
| | | 25°C | | 15 | | | 15 | dB | |

† Full range is – 40°C to 125°C for Q suffix, – 55°C to 125°C for M suffix.

TLC225x, TLC225xA Advanced LinCMOS™ RAIL-TO-RAIL VERY LOW-POWER OPERATIONAL AMPLIFIERS

SLOS176D – FEBRUARY 1997 – REVISED MARCH 2001

electrical characteristics at specified free-air temperature, $V_{DD} = 5\text{ V}$ (unless otherwise noted)

| PARAMETER | TEST CONDITIONS | T_A † | TLC2254Q TLC2254M | | | TLC2254AQ TLC2254AM | | | UNIT | |
|----------------------------------------------------------------------------|---------------------------------------------------------------------------------|------------------------------------------------------------|------------------------------|-------------|----------|------------------------|-------------|---------------|------------------------------|------|
| | | | MIN | TYP | MAX | MIN | TYP | MAX | | |
| V_{IO} Input offset voltage | | 25°C | 200 | 1500 | | 200 | 850 | μV | | |
| | | Full range | | 1750 | | 1000 | | | | |
| α_{VIO} Temperature coefficient of input offset voltage | | 25°C to 125°C | 0.5 | | | 0.5 | | | $\mu\text{V}/^\circ\text{C}$ | |
| Input offset voltage long-term drift (see Note 4) | $V_{DD\pm} = \pm 2.5\text{ V}$, $V_{IC} = 0$, $V_O = 0$, $R_S = 50\ \Omega$ | 25°C | 0.003 | | | 0.003 | | | $\mu\text{V}/\text{mo}$ | |
| I_{IO} Input offset current | | 25°C | 0.5 | 60 | | 0.5 | 60 | pA | | |
| | | 125°C | 1000 | | | 1000 | | | | |
| I_{IB} Input bias current | | 25°C | 1 | 60 | | 1 | 60 | pA | | |
| | | 125°C | 1000 | | | 1000 | | | | |
| V_{ICR} Common-mode input voltage range | $R_S = 50\ \Omega$, $ V_{IO} \leq 5\text{ mV}$ | 25°C | 0 to 4 | -0.3 to 4.2 | | 0 to 4 | -0.3 to 4.2 | V | | |
| | | Full range | 0 to 3.5 | | 0 to 3.5 | | | | | |
| V_{OH} High-level output voltage | $I_{OH} = -20\ \mu\text{A}$ | 25°C | 4.98 | | | 4.98 | | | V | |
| | $I_{OH} = -75\ \mu\text{A}$ | 25°C | 4.9 | 4.94 | | 4.9 | 4.94 | | | |
| | Full range | | 4.8 | | | 4.8 | | | | |
| | $I_{OH} = -150\ \mu\text{A}$ | 25°C | 4.8 | 4.88 | | 4.8 | 4.88 | | | |
| V_{OL} Low-level output voltage | $V_{IC} = 2.5\text{ V}$, $I_{OL} = 50\ \mu\text{A}$ | 25°C | 0.01 | | | 0.01 | | | V | |
| | $V_{IC} = 2.5\text{ V}$, $I_{OL} = 500\ \mu\text{A}$ | 25°C | 0.09 | 0.15 | | 0.09 | 0.15 | | | |
| | | Full range | 0.15 | | | 0.15 | | | | |
| | $V_{IC} = 2.5\text{ V}$, $I_{OL} = 4\text{ mA}$ | 25°C | 0.8 | 1 | | 0.7 | 1 | | | |
| | | Full range | 1.2 | | | 1.2 | | | | |
| | A_{VD} Large-signal differential voltage amplification | $V_{IC} = 2.5\text{ V}$, $V_O = 1\text{ V to }4\text{ V}$ | $R_L = 100\text{ k}\Omega$ ‡ | 25°C | 100 | 350 | 100 | 350 | | V/mV |
| Full range | | | | 10 | | | 10 | | | |
| $R_L = 1\text{ M}\Omega$ ‡ | | | 25°C | 1700 | | | 1700 | | | |
| $r_{i(d)}$ Differential input resistance | | 25°C | 1012 | | | 1012 | | | Ω | |
| $r_{i(c)}$ Common-mode input resistance | | 25°C | 1012 | | | 1012 | | | Ω | |
| $C_{i(c)}$ Common-mode input capacitance | $f = 10\text{ kHz}$, N package | 25°C | 8 | | | 8 | | | pF | |
| z_o Closed-loop output impedance | $f = 25\text{ kHz}$, $A_V = 10$ | 25°C | 200 | | | 200 | | | Ω | |
| CMRR Common-mode rejection ratio | $V_{IC} = 0\text{ to }2.7\text{ V}$, $V_O = 2.5\text{ V}$, $R_S = 50\ \Omega$ | 25°C | 70 | 83 | | 70 | 83 | dB | | |
| | | Full range | 70 | | | 70 | | | | |
| k_{SVR} Supply-voltage rejection ratio ($\Delta V_{DD}/\Delta V_{IO}$) | $V_{DD} = 4.4\text{ V to }16\text{ V}$, $V_{IC} = V_{DD}/2$, No load | 25°C | 80 | 95 | | 80 | 95 | dB | | |
| | | Full range | 80 | | | 80 | | | | |
| I_{DD} Supply current (four amplifiers) | $V_O = 2.5\text{ V}$, No load | 25°C | 140 | 250 | | 140 | 250 | μA | | |
| | | Full range | 300 | | | 300 | | | | |

† Full range is -40°C to 125°C for Q suffix, -55°C to 125°C for M suffix.

‡ Referenced to 2.5 V

NOTE 4: Typical values are based on the input offset voltage shift observed through 500 hours of operating life test at $T_A = 150^\circ\text{C}$ extrapolated to $T_A = 25^\circ\text{C}$ using the Arrhenius equation and assuming an activation energy of 0.96 eV.



TLC225x, TLC225xA
Advanced LinCMOS™ RAIL-TO-RAIL
VERY LOW-POWER OPERATIONAL AMPLIFIERS

SLOS176D – FEBRUARY 1997 – REVISED MARCH 2001

operating characteristics at specified free-air temperature, $V_{DD} = 5\text{ V}$

| PARAMETER | TEST CONDITIONS | T_A † | TLC2254Q TLC2254M | | | TLC2254AQ TLC2254AM | | | UNIT |
|-------------|----------------------------------------------------------------------------------------------------------------------------------------|----------------------------------------------|----------------------|------|-----|------------------------|------|-----|------------------------|
| | | | MIN | TYP | MAX | MIN | TYP | MAX | |
| SR | Slew rate at unity gain $V_O = 0.5\text{ V to }3.5\text{ V}$, $R_L = 100\text{ k}\Omega$ ‡, $C_L = 100\text{ pF}$ ‡ | 25°C | 0.07 | 0.12 | | 0.07 | 0.12 | | V/ μ s |
| | | Full range | 0.05 | | | 0.05 | | | |
| V_n | Equivalent input noise voltage | $f = 10\text{ Hz}$ | 36 | | | 36 | | | nV/ $\sqrt{\text{Hz}}$ |
| | | $f = 1\text{ kHz}$ | 19 | | | 19 | | | |
| $V_{N(PP)}$ | Peak-to-peak equivalent input noise voltage | $f = 0.1\text{ Hz to }1\text{ Hz}$ | 0.7 | | | 0.7 | | | μ V |
| | | $f = 0.1\text{ Hz to }10\text{ Hz}$ | 1.1 | | | 1.1 | | | |
| I_n | Equivalent input noise current | 25°C | 0.6 | | | 0.6 | | | fA/ $\sqrt{\text{Hz}}$ |
| THD + N | Total harmonic distortion plus noise $V_O = 0.5\text{ V to }2.5\text{ V}$, $f = 20\text{ kHz}$, $R_L = 50\text{ k}\Omega$ ‡ | $A_V = 1$ | 0.2% | | | 0.2% | | | |
| | | $A_V = 10$ | 1% | | | 1% | | | |
| | Gain-bandwidth product $f = 50\text{ kHz}$, $C_L = 100\text{ pF}$ ‡ | $R_L = 50\text{ k}\Omega$ ‡, 25°C | 0.2 | | | 0.2 | | | MHz |
| B_{OM} | Maximum output-swing bandwidth $V_{O(PP)} = 2\text{ V}$, $R_L = 50\text{ k}\Omega$ ‡ | $A_V = 1$, $C_L = 100\text{ pF}$ ‡, 25°C | 30 | | | 30 | | | kHz |
| ϕ_m | Phase margin at unity gain $R_L = 50\text{ k}\Omega$ ‡, $C_L = 100\text{ pF}$ ‡ | 25°C | 63° | | | 63° | | | |
| | | 25°C | 15 | | | 15 | | | dB |

† Full range is – 40°C to 125°C for Q suffix, – 55°C to 125°C for M suffix.

‡ Referenced to 2.5 V

TLC225x, TLC225xA
Advanced LinCMOS™ RAIL-TO-RAIL
VERY LOW-POWER OPERATIONAL AMPLIFIERS

SLOS176D – FEBRUARY 1997 – REVISED MARCH 2001

electrical characteristics at specified free-air temperature, $V_{DD\pm} = \pm 5$ V (unless otherwise noted)

| PARAMETER | TEST CONDITIONS | T_A † | TLC2254Q TLC2254M | | | TLC2254AQ TLC2254AM | | | UNIT |
|---------------------------------------------------------------------------------|------------------------------------------------------------------|---------------------|----------------------|-------------|------|------------------------|-------------|------------------|------|
| | | | MIN | TYP | MAX | MIN | TYP | MAX | |
| V_{IO} Input offset voltage | $V_{IC} = 0, V_O = 0, R_S = 50 \Omega$ | 25°C | 200 | 1500 | | 200 | 850 | μV | |
| | | Full range | | | 1750 | | 1000 | | |
| αV_{IO} Temperature coefficient of input offset voltage | | 25°C to 125°C | 0.5 | | | 0.5 | | $\mu V/^\circ C$ | |
| Input offset voltage long-term drift (see Note 4) | | 25°C | 0.003 | | | 0.003 | | $\mu V/mo$ | |
| I_{IO} Input offset current | | 25°C | 0.5 | 60 | | 0.5 | 60 | pA | |
| | | 125°C | | | 1000 | | 1000 | | |
| I_{IB} Input bias current | 25°C | 1 | 60 | | 1 | 60 | pA | | |
| | 125°C | | | 1000 | | 1000 | | | |
| V_{ICR} Common-mode input voltage range | $R_S = 50 \Omega, V_{IO} \leq 5 mV$ | 25°C | -5 to 4 | -5.3 to 4.2 | | -5 to 4 | -5.3 to 4.2 | V | |
| | | Full range | -5 to 3.5 | | | -5 to 3.5 | | | |
| V_{OM+} Maximum positive peak output voltage | $I_O = -20 \mu A$ | 25°C | 4.98 | | | 4.98 | V | | |
| | $I_O = -100 \mu A$ | 25°C | 4.9 | 4.93 | | 4.9 | | 4.93 | |
| | | Full range | 4.7 | | | 4.7 | | | |
| | $I_O = -200 \mu A$ | 25°C | 4.8 | 4.86 | | 4.8 | | 4.86 | |
| V_{OM-} Maximum negative peak output voltage | $V_{IC} = 0, I_O = 50 \mu A$ | 25°C | -4.99 | | | -4.99 | V | | |
| | $V_{IC} = 0, I_O = 500 \mu A$ | 25°C | -4.85 | -4.91 | | -4.85 | | -4.91 | |
| | | Full range | -4.85 | | | -4.85 | | | |
| | $V_{IC} = 0, I_O = 4 mA$ | 25°C | -4 | -4.3 | | -4 | | -4.3 | |
| | | Full range | -3.8 | | | -3.8 | | | |
| A_{VD} Large-signal differential voltage amplification | $V_O = \pm 4 V$ | $R_L = 100 k\Omega$ | 25°C | 40 | 150 | | 40 | 150 | V/mV |
| | | | Full range | 10 | | | 10 | | |
| | | $R_L = 1 M\Omega$ | 25°C | 3000 | | | 3000 | | |
| $r_{i(d)}$ Differential input resistance | | 25°C | 10 ¹² | | | 10 ¹² | Ω | | |
| $r_{i(c)}$ Common-mode input resistance | | 25°C | 10 ¹² | | | 10 ¹² | Ω | | |
| $C_{i(c)}$ Common-mode input capacitance | $f = 10 kHz, N$ package | 25°C | 8 | | | 8 | pF | | |
| z_o Closed-loop output impedance | $f = 25 kHz, A_V = 10$ | 25°C | 190 | | | 190 | Ω | | |
| CMRR Common-mode rejection ratio | $V_{IC} = -5 V$ to 2.7 V, $V_O = 0, R_S = 50 \Omega$ | 25°C | 75 | 88 | | 75 | 88 | dB | |
| | | Full range | 75 | | | 75 | | | |
| k_{SVR} Supply-voltage rejection ratio ($\Delta V_{DD\pm} / \Delta V_{IO}$) | $V_{DD\pm} = \pm 2.2 V$ to $\pm 8 V, V_{IC} = V_{DD}/2, No load$ | 25°C | 80 | 95 | | 80 | 95 | dB | |
| | | Full range | 80 | | | 80 | | | |
| I_{DD} Supply current (four amplifiers) | $V_O = 0, No load$ | 25°C | 160 | 250 | | 160 | 250 | μA | |
| | | Full range | | | 300 | | 300 | | |

† Full range is -40°C to 125°C for Q suffix, -55°C to 125°C for M suffix.

NOTE 4: Typical values are based on the input offset voltage shift observed through 500 hours of operating life test at $T_A = 150^\circ C$ extrapolated to $T_A = 25^\circ C$ using the Arrhenius equation and assuming an activation energy of 0.96 eV.



TLC225x, TLC225xA
Advanced LinCMOS™ RAIL-TO-RAIL
VERY LOW-POWER OPERATIONAL AMPLIFIERS

SLOS176D – FEBRUARY 1997 – REVISED MARCH 2001

operating characteristics at specified free-air temperature, $V_{DD\pm} = \pm 5\text{ V}$

| PARAMETER | TEST CONDITIONS | | T_A † | TLC2254Q TLC2254M | | | TLC2254AQ TLC2254AM | | | UNIT |
|---------------------------------------------------------|----------------------------------------------------------------------------------|--------------------------------------|-------------|----------------------|------|-----|------------------------|------|-----|------------------------|
| | | | | MIN | TYP | MAX | MIN | TYP | MAX | |
| SR Slew rate at unity gain | $V_O = \pm 2\text{ V}$, $C_L = 100\text{ pF}$ | $R_L = 100\text{ k}\Omega$, | 25°C | 0.07 | 0.12 | | 0.07 | 0.12 | | V/ μ s |
| | | | Full range | 0.05 | | | 0.05 | | | |
| V_n Equivalent input noise voltage | $f = 10\text{ Hz}$ | | 25°C | 38 | | | 38 | | | nV/ $\sqrt{\text{Hz}}$ |
| | $f = 1\text{ kHz}$ | | 25°C | 19 | | | 19 | | | |
| $V_{N(PP)}$ Peak-to-peak equivalent input noise voltage | $f = 0.1\text{ Hz to }1\text{ Hz}$ | | 25°C | 0.8 | | | 0.8 | | | μ V |
| | $f = 0.1\text{ Hz to }10\text{ Hz}$ | | 25°C | 1.1 | | | 1.1 | | | |
| I_n Equivalent input noise current | | | 25°C | 0.6 | | | 0.6 | | | fA/ $\sqrt{\text{Hz}}$ |
| THD + N Total harmonic distortion plus noise | $V_O = \pm 2.3\text{ V}$, $R_L = 50\text{ k}\Omega$, $f = 20\text{ kHz}$ | $A_V = 1$ | 25°C | 0.2% | | | 0.2% | | | |
| | | $A_V = 10$ | | 1% | | | 1% | | | |
| Gain-bandwidth product | $f = 10\text{ kHz}$, $C_L = 100\text{ pF}$ | $R_L = 50\text{ k}\Omega$, | 25°C | 0.21 | | | 0.21 | | | MHz |
| B_{OM} Maximum output-swing bandwidth | $V_{O(PP)} = 4.6\text{ V}$, $R_L = 50\text{ k}\Omega$, | $A_V = 1$, $C_L = 100\text{ pF}$ | 25°C | 14 | | | 14 | | | kHz |
| ϕ_m Phase margin at unity gain | $R_L = 50\text{ k}\Omega$, | $C_L = 100\text{ pF}$ | 25°C | 63° | | | 63° | | | |
| | | | Gain margin | 25°C | 15 | | | 15 | | |

† Full range is – 40°C to 125°C for Q suffix, – 55°C to 125°C for M suffix.

TLC225x, TLC225xA
Advanced LinCMOS™ RAIL-TO-RAIL
VERY LOW-POWER OPERATIONAL AMPLIFIERS

SLOS176D – FEBRUARY 1997 – REVISED MARCH 2001

TYPICAL CHARACTERISTICS

Table of Graphs

| | | FIGURE | |
|-----------------|-------------------------------------------------|------------------------------------------------|------------------|
| V_{IO} | Input offset voltage | Distribution vs Common-mode input voltage | 2 – 5 6, 7 |
| αV_{IO} | Input offset voltage temperature coefficient | Distribution | 8 – 11 |
| I_{IB}/I_{IO} | Input bias and input offset currents | vs Free-air temperature | 12 |
| V_I | Input voltage range | vs Supply voltage vs Free-air temperature | 13 14 |
| V_{OH} | High-level output voltage | vs High-level output current | 15 |
| V_{OL} | Low-level output voltage | vs Low-level output current | 16, 17 |
| V_{OM+} | Maximum positive peak output voltage | vs Output current | 18 |
| V_{OM-} | Maximum negative peak output voltage | vs Output current | 19 |
| $V_{O(PP)}$ | Maximum peak-to-peak output voltage | vs Frequency | 20 |
| I_{OS} | Short-circuit output current | vs Supply voltage vs Free-air temperature | 21 22 |
| V_O | Output voltage | vs Differential input voltage | 23, 24 |
| | Differential gain | vs Load resistance | 25 |
| A_{VD} | Large-signal differential voltage amplification | vs Frequency vs Free-air temperature | 26, 27 28, 29 |
| z_o | Output impedance | vs Frequency | 30, 31 |
| CMRR | Common-mode rejection ratio | vs Frequency vs Free-air temperature | 32 33 |
| k_{SVR} | Supply-voltage rejection ratio | vs Frequency vs Free-air temperature | 34, 35 36 |
| I_{DD} | Supply current | vs Supply voltage vs Free-air temperature | 37 38 |
| SR | Slew rate | vs Load capacitance vs Free-air temperature | 39 40 |
| V_O | Inverting large-signal pulse response | | 41, 42 |
| V_O | Voltage-follower large-signal pulse response | | 43, 44 |
| V_O | Inverting small-signal pulse response | | 45, 46 |
| V_O | Voltage-follower small-signal pulse response | | 47, 48 |
| V_n | Equivalent input noise voltage | vs Frequency | 49, 50 |
| | Noise voltage (referred to input) | Over a 10-second period | 51 |
| | Integrated noise voltage | vs Frequency | 52 |
| THD + N | Total harmonic distortion plus noise | vs Frequency | 53 |
| | Gain-bandwidth product | vs Free-air temperature vs Supply voltage | 54 55 |
| ϕ_m | Phase margin | vs Frequency vs Load capacitance | 26, 27 56 |
| A_m | Gain margin | vs Load capacitance | 57 |
| B_1 | Unity-gain bandwidth | vs Load capacitance | 58 |
| | Overestimation of phase margin | vs Load capacitance | 59 |



TYPICAL CHARACTERISTICS

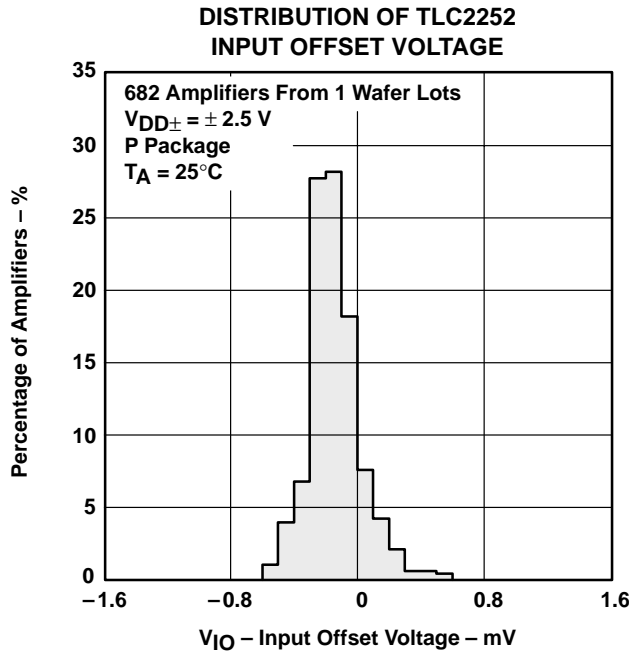

Figure 2

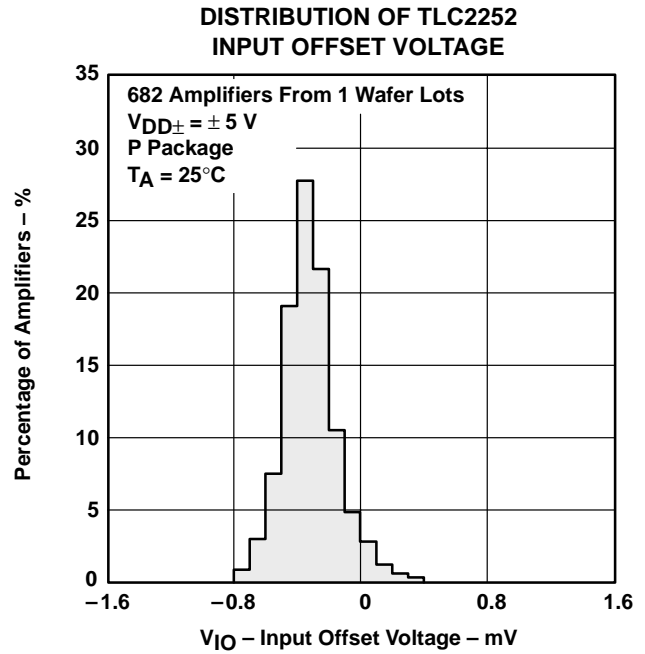

Figure 3

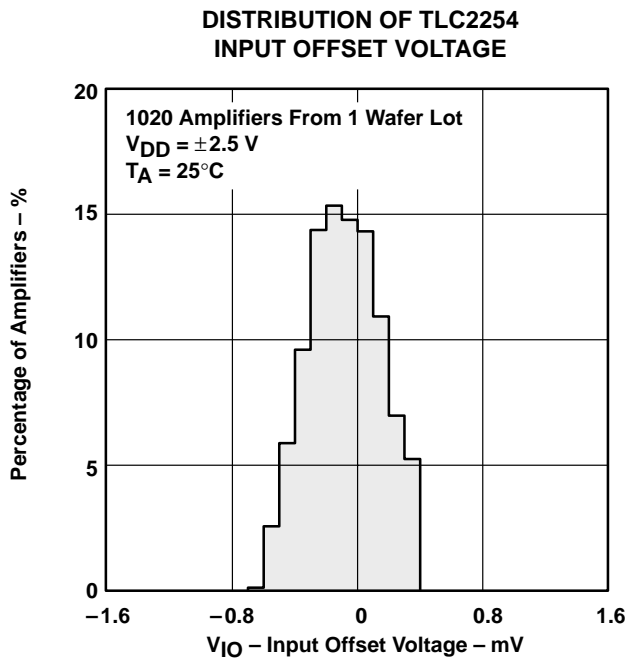

Figure 4

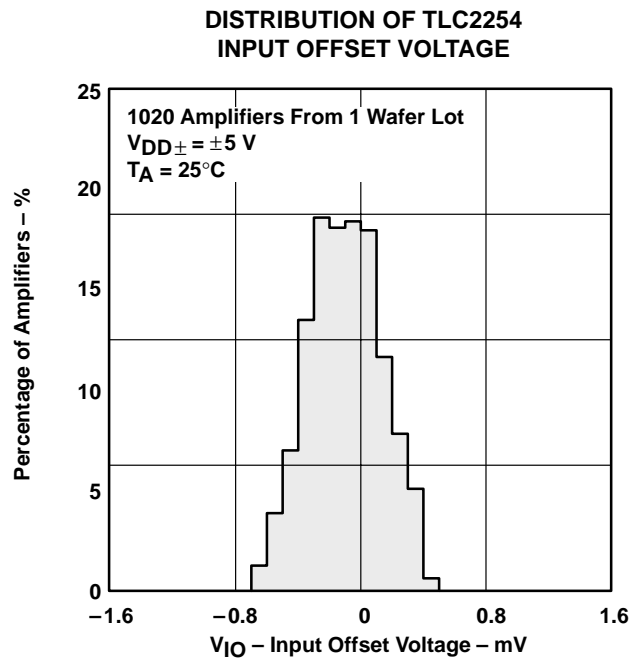

Figure 5

TLC225x, TLC225xA
Advanced LinCMOS™ RAIL-TO-RAIL
VERY LOW-POWER OPERATIONAL AMPLIFIERS

SLOS176D – FEBRUARY 1997 – REVISED MARCH 2001

TYPICAL CHARACTERISTICS

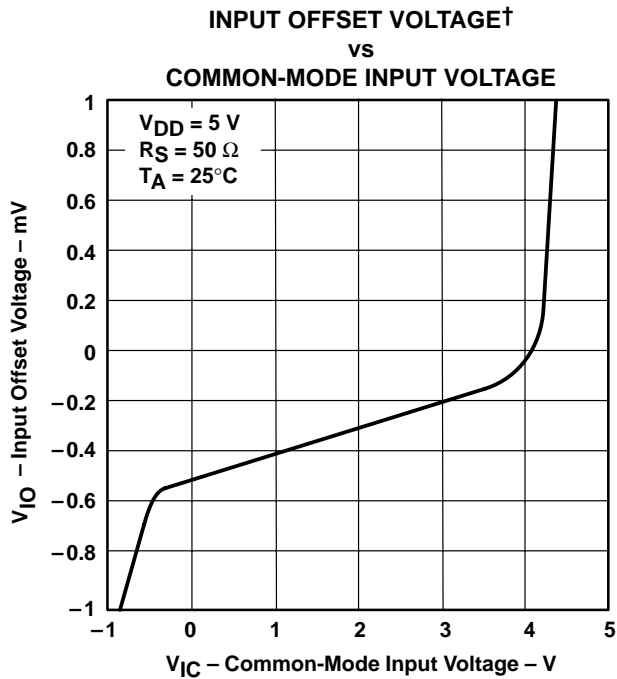

Figure 6

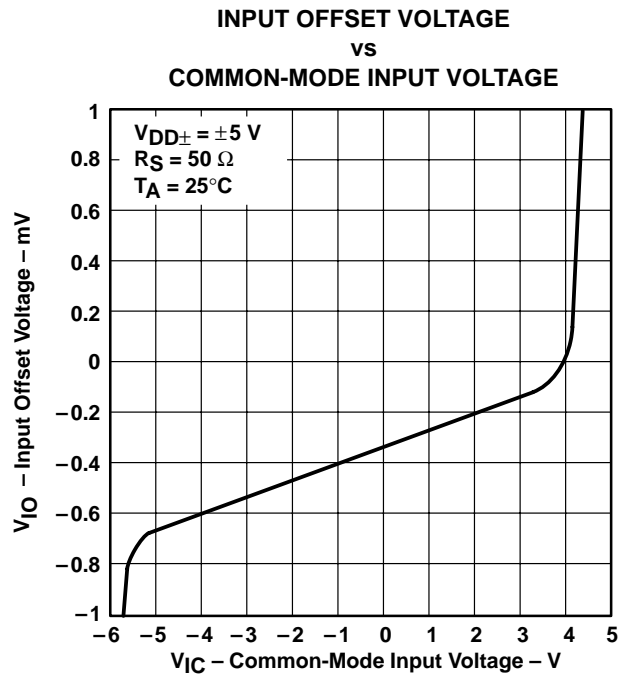

Figure 7

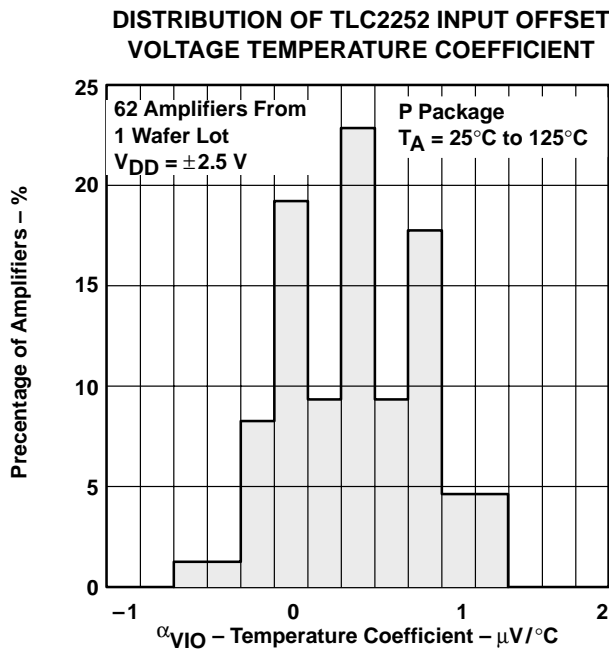

Figure 8

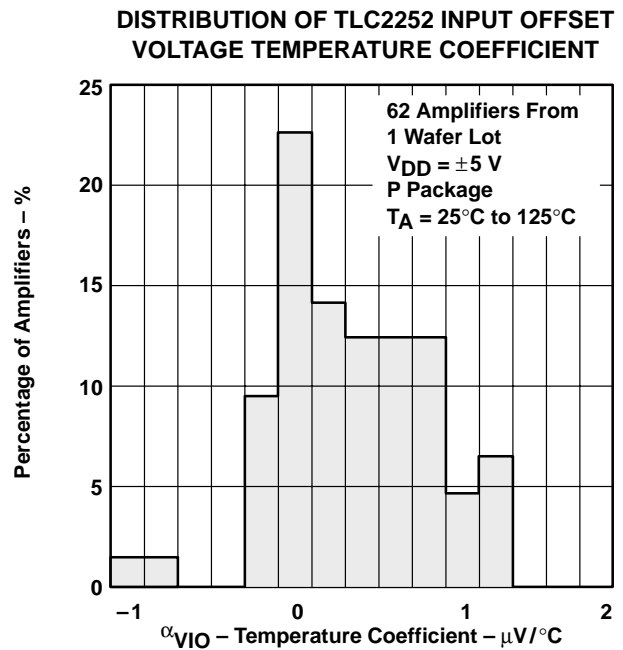

Figure 9

† For curves where $V_{DD} = 5\text{ V}$, all loads are referenced to 2.5 V.

TYPICAL CHARACTERISTICS

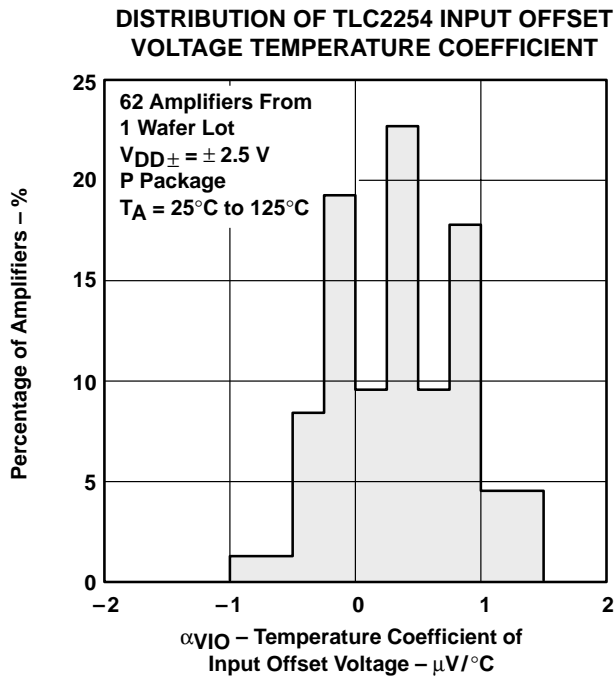

Figure 10



Figure 11

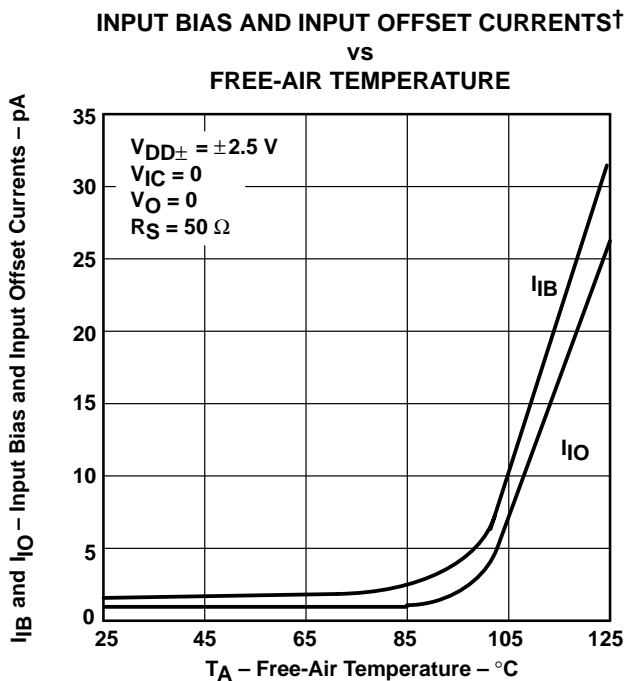

Figure 12



Figure 13

† Data at high and low temperatures are applicable only within the rated operating free-air temperature ranges of the various devices.

TYPICAL CHARACTERISTICS

INPUT VOLTAGE RANGE†
vs
FREE-AIR TEMPERATURE

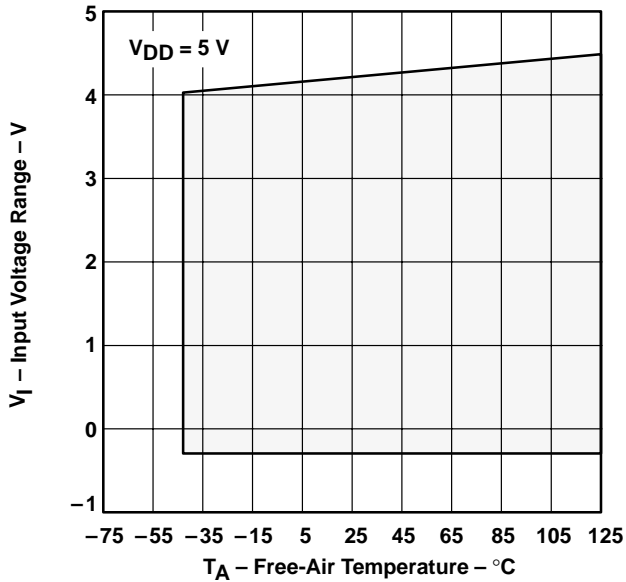

Figure 14

HIGH-LEVEL OUTPUT VOLTAGE†‡
vs
HIGH-LEVEL OUTPUT CURRENT

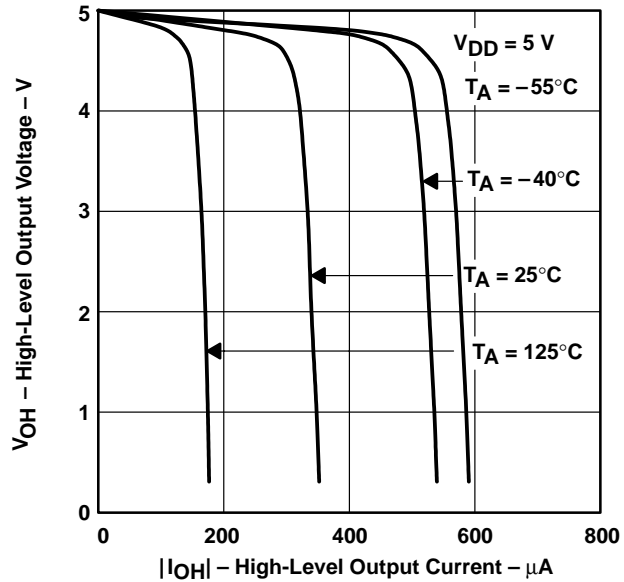

Figure 15

LOW-LEVEL OUTPUT VOLTAGE†
vs
LOW-LEVEL OUTPUT CURRENT

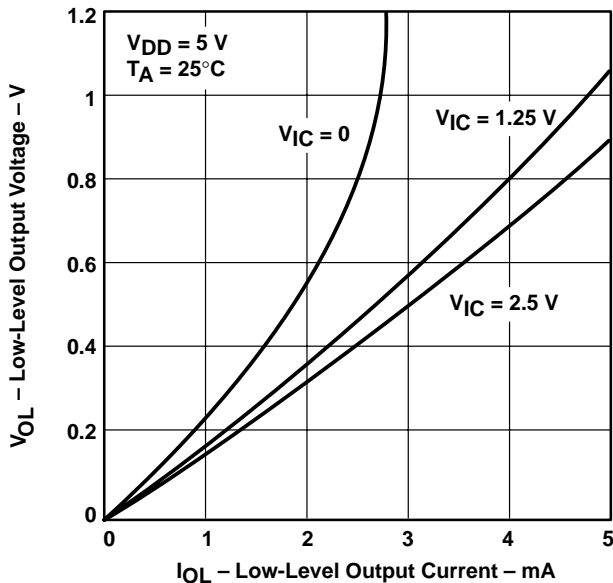

Figure 16

LOW-LEVEL OUTPUT VOLTAGE†‡
vs
LOW-LEVEL OUTPUT CURRENT

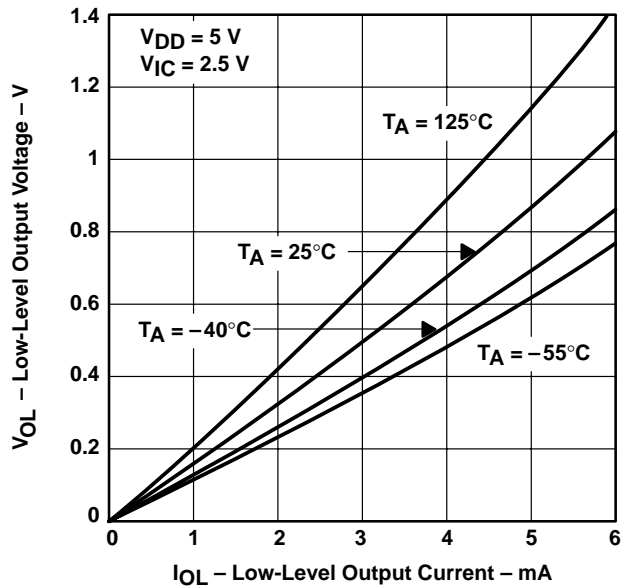

Figure 17

† Data at high and low temperatures are applicable only within the rated operating free-air temperature ranges of the various devices.
 ‡ For curves where $V_{DD} = 5\text{ V}$, all loads are referenced to 2.5 V.

TYPICAL CHARACTERISTICS

MAXIMUM POSITIVE PEAK OUTPUT VOLTAGE†
 vs
 OUTPUT CURRENT

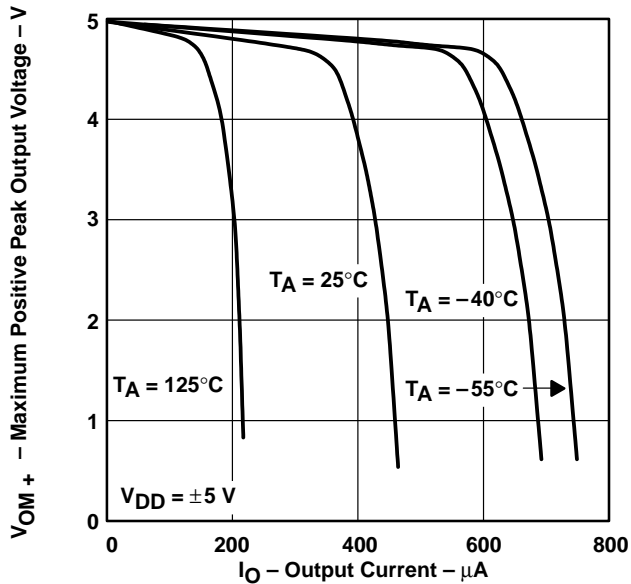

Figure 18

MAXIMUM NEGATIVE PEAK OUTPUT VOLTAGE†
 vs
 OUTPUT CURRENT

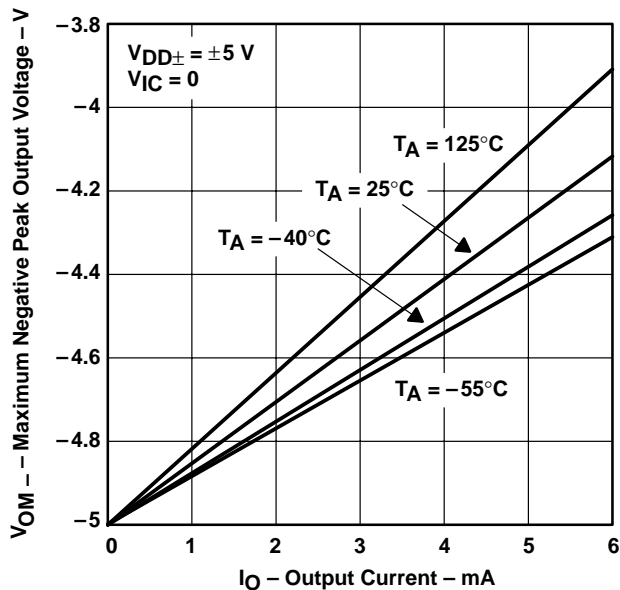

Figure 19

MAXIMUM PEAK-TO-PEAK OUTPUT VOLTAGE‡
 vs
 FREQUENCY

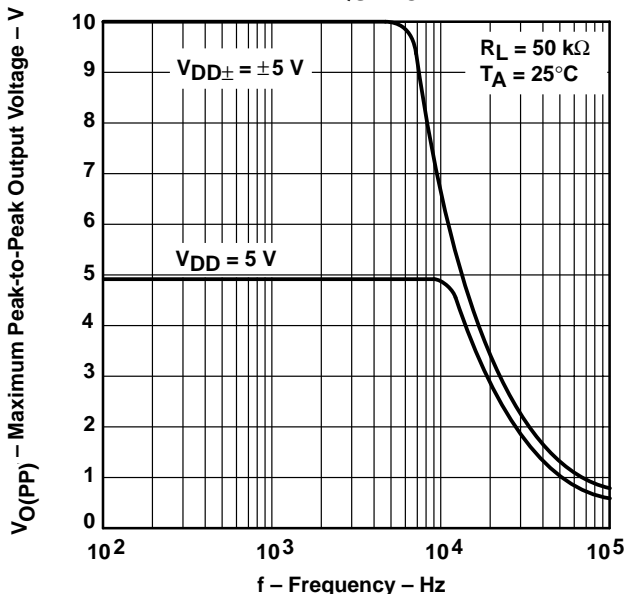

Figure 20

SHORT-CIRCUIT OUTPUT CURRENT
 vs
 SUPPLY VOLTAGE

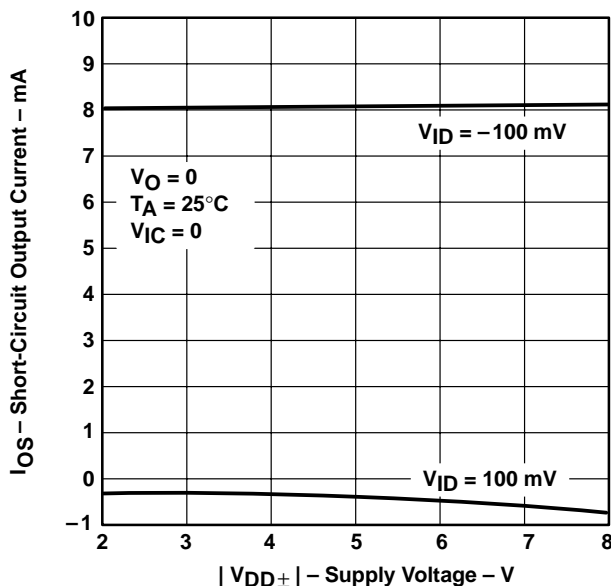

Figure 21

† Data at high and low temperatures are applicable only within the rated operating free-air temperature ranges of the various devices.

‡ For curves where $V_{DD} = 5\text{ V}$, all loads are referenced to 2.5 V .

TYPICAL CHARACTERISTICS



Figure 22

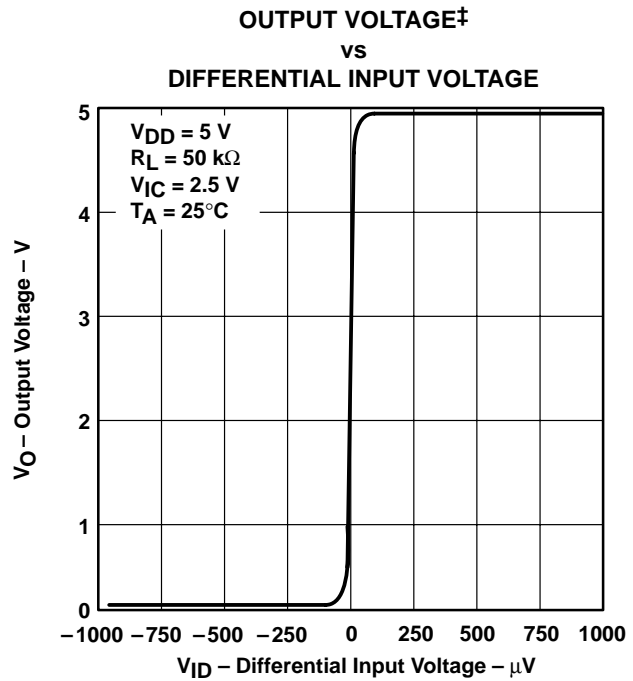

Figure 23

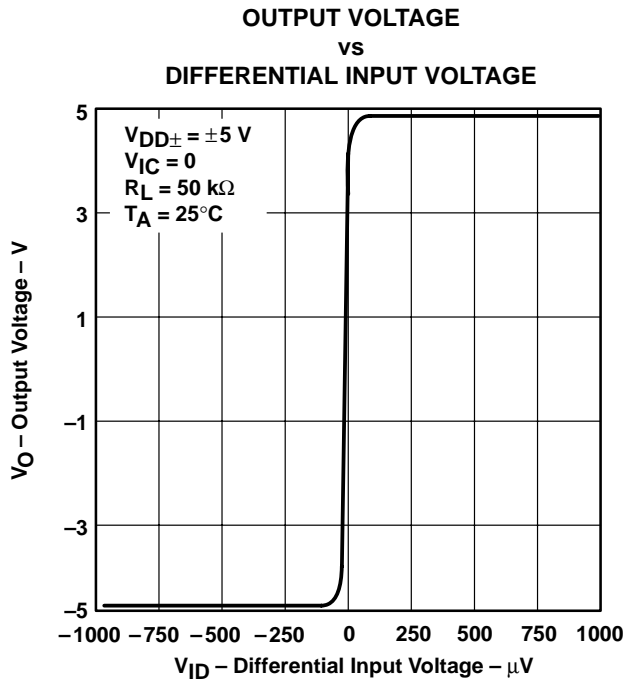

Figure 24

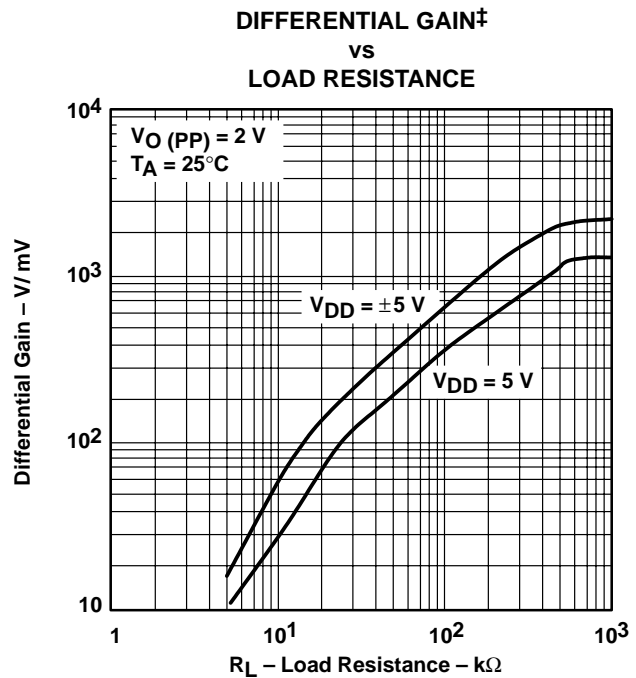

Figure 25

† Data at high and low temperatures are applicable only within the rated operating free-air temperature ranges of the various devices.

‡ For curves where $V_{DD} = 5 V$, all loads are referenced to 2.5 V.

TYPICAL CHARACTERISTICS

LARGE-SIGNAL DIFFERENTIAL VOLTAGE
 AMPLIFICATION AND PHASE MARGIN†
 VS
 FREQUENCY



Figure 26

LARGE-SIGNAL DIFFERENTIAL VOLTAGE
 AMPLIFICATION AND PHASE MARGIN
 VS
 FREQUENCY

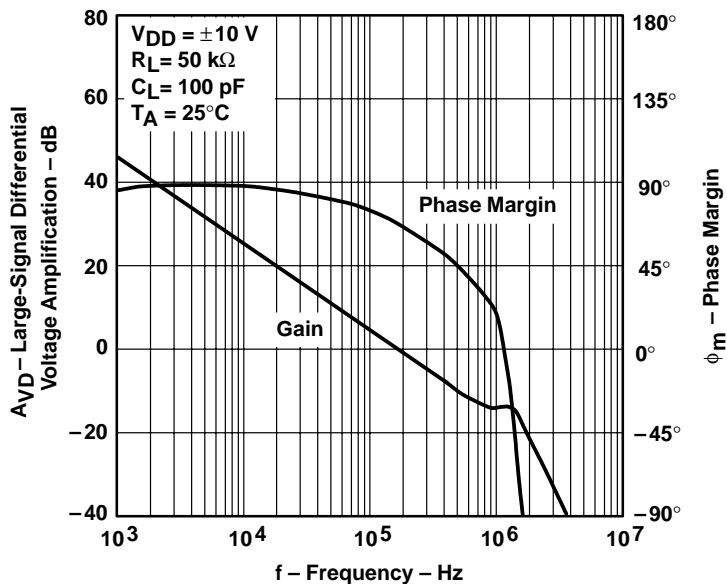

Figure 27

† For curves where $V_{DD} = 5\text{ V}$, all loads are referenced to 2.5 V.

TLC225x, TLC225xA
Advanced LinCMOS™ RAIL-TO-RAIL
VERY LOW-POWER OPERATIONAL AMPLIFIERS

SLOS176D – FEBRUARY 1997 – REVISED MARCH 2001

TYPICAL CHARACTERISTICS

LARGE-SIGNAL DIFFERENTIAL VOLTAGE AMPLIFICATION†‡
vs
FREE-AIR TEMPERATURE

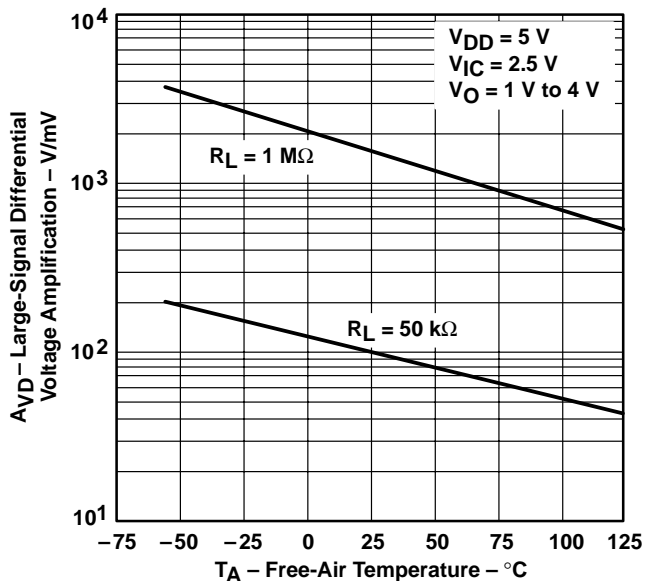

Figure 28

LARGE-SIGNAL DIFFERENTIAL VOLTAGE AMPLIFICATION†
vs
FREE-AIR TEMPERATURE

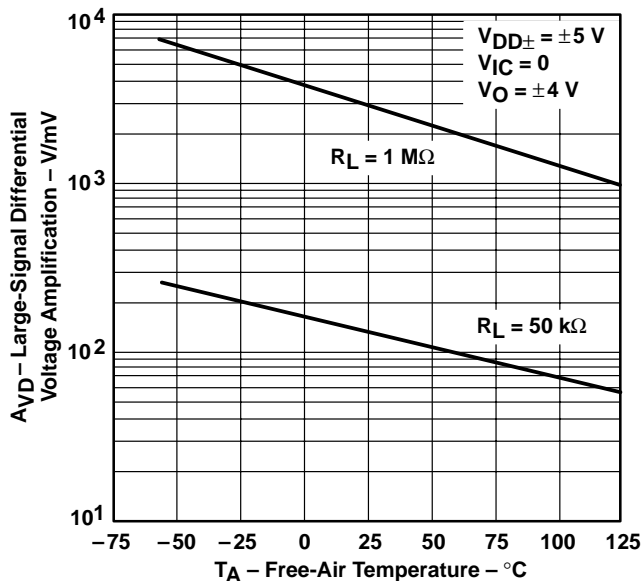

Figure 29

OUTPUT IMPEDANCE‡
vs
FREQUENCY

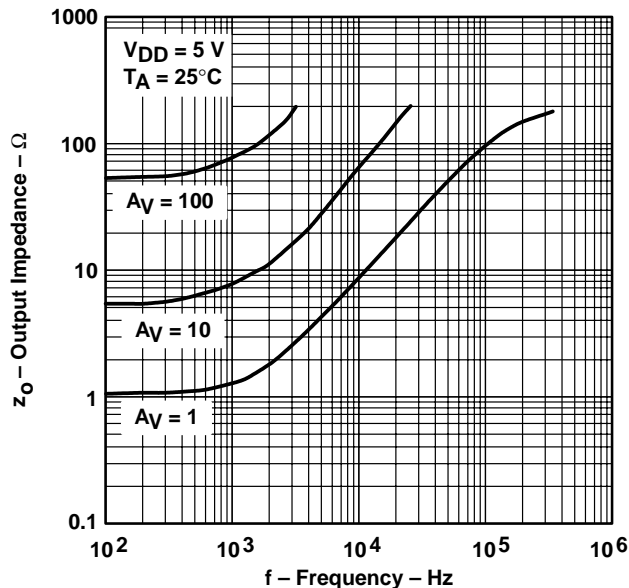

Figure 30

OUTPUT IMPEDANCE
vs
FREQUENCY

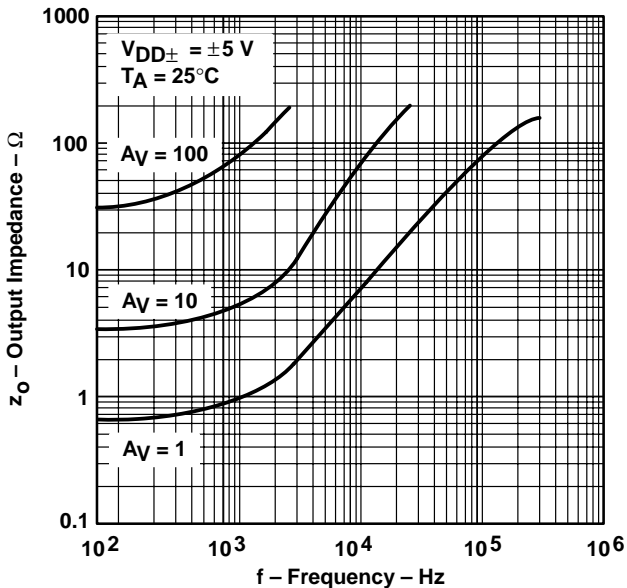

Figure 31

† Data at high and low temperatures are applicable only within the rated operating free-air temperature ranges of the various devices.

‡ For curves where $V_{DD} = 5\text{ V}$, all loads are referenced to 2.5 V.



TYPICAL CHARACTERISTICS



Figure 32

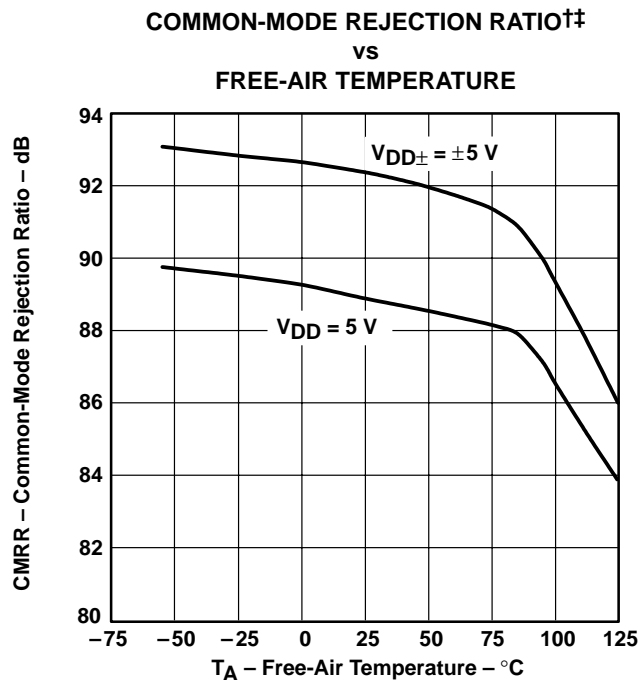

Figure 33



Figure 34

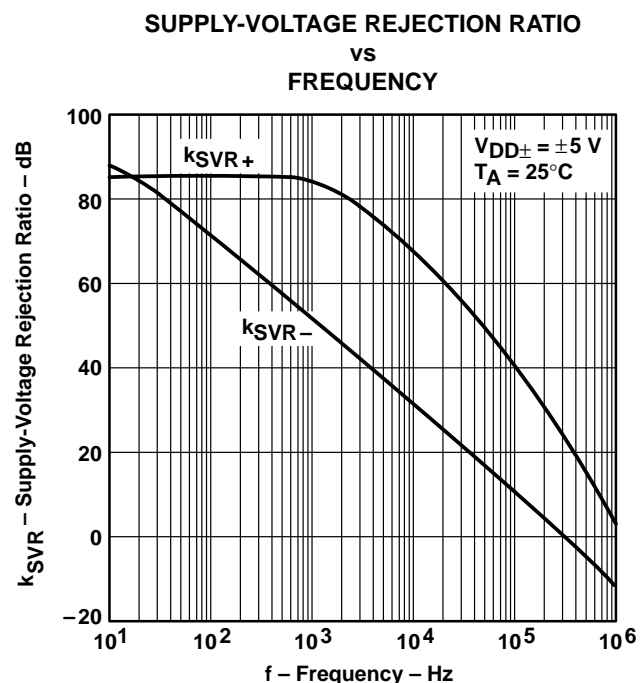
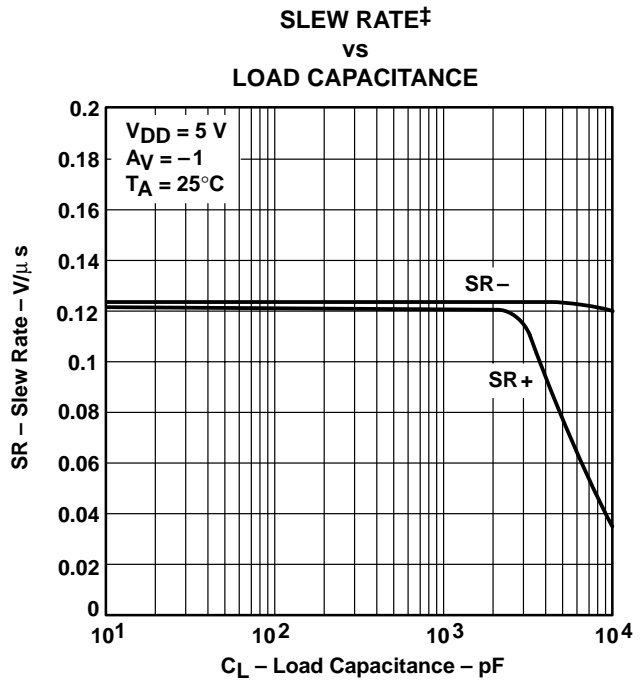
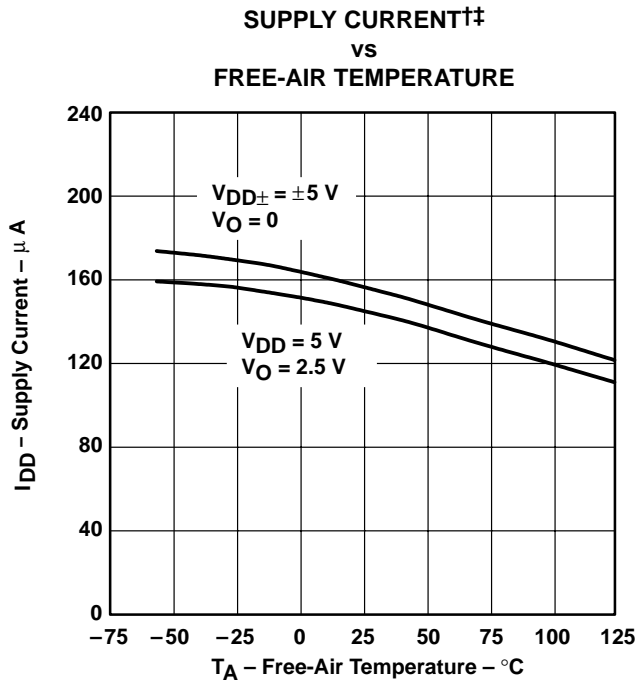
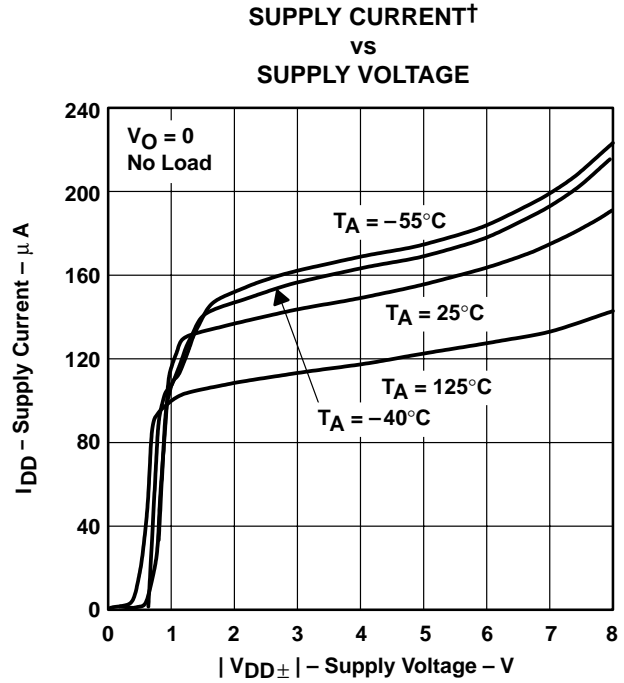
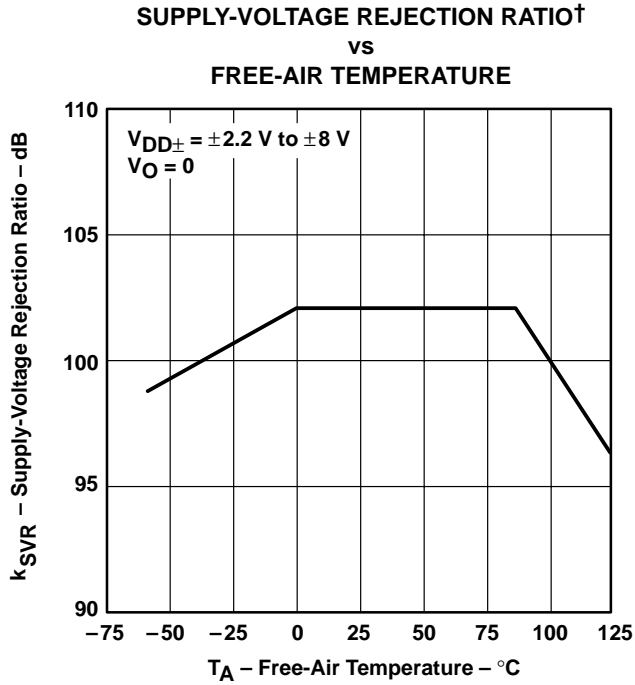

Figure 35

† For curves where $V_{DD} = 5\text{ V}$, all loads are referenced to 2.5 V .

†† Data at high and low temperatures are applicable only within the rated operating free-air temperature ranges of the various devices.

TYPICAL CHARACTERISTICS



† Data at high and low temperatures are applicable only within the rated operating free-air temperature ranges of the various devices.

‡ For curves where $V_{DD} = 5\text{ V}$, all loads are referenced to 2.5 V.

TYPICAL CHARACTERISTICS

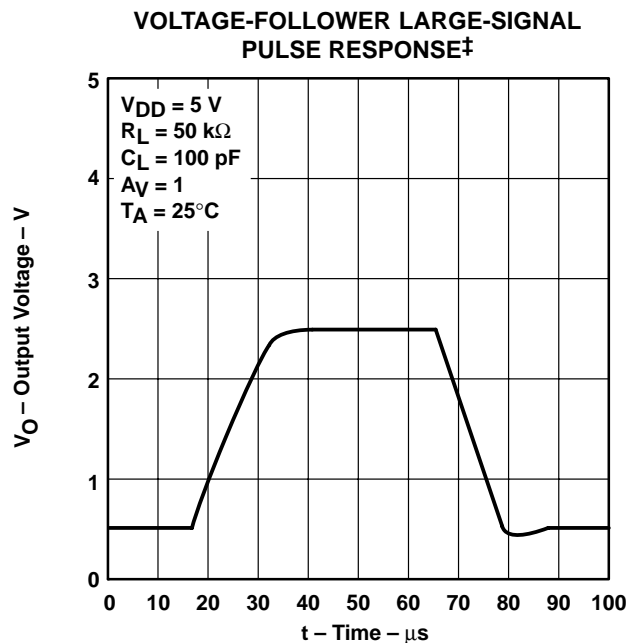
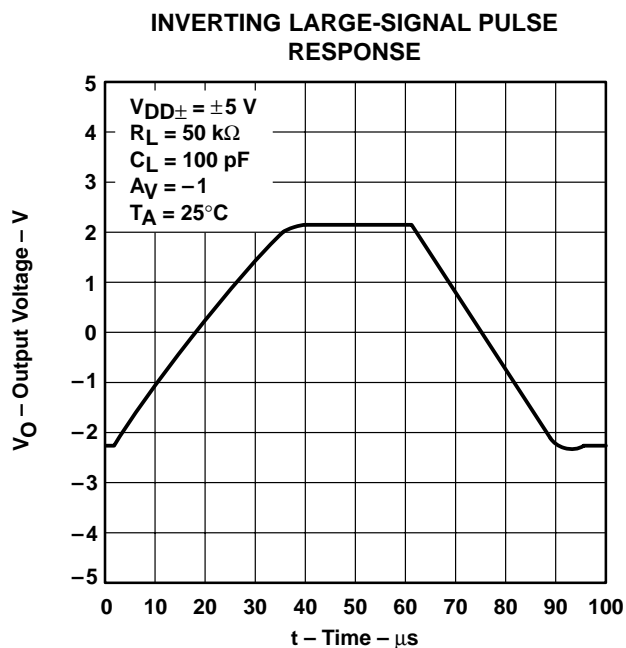
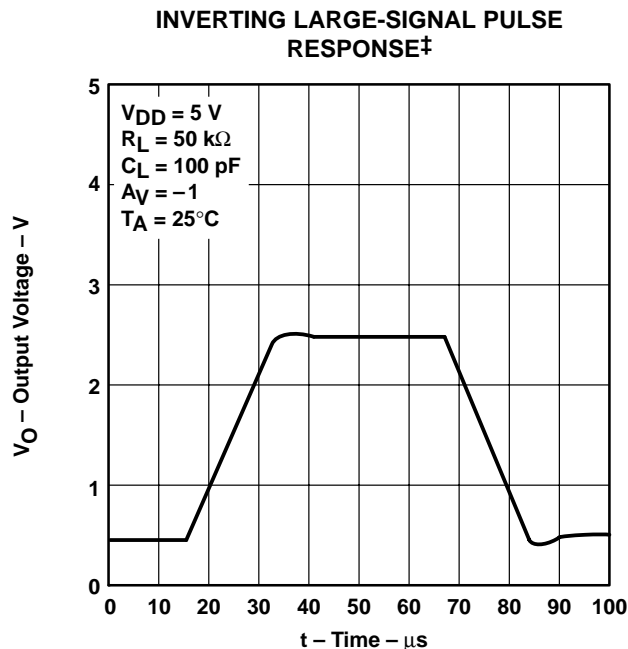
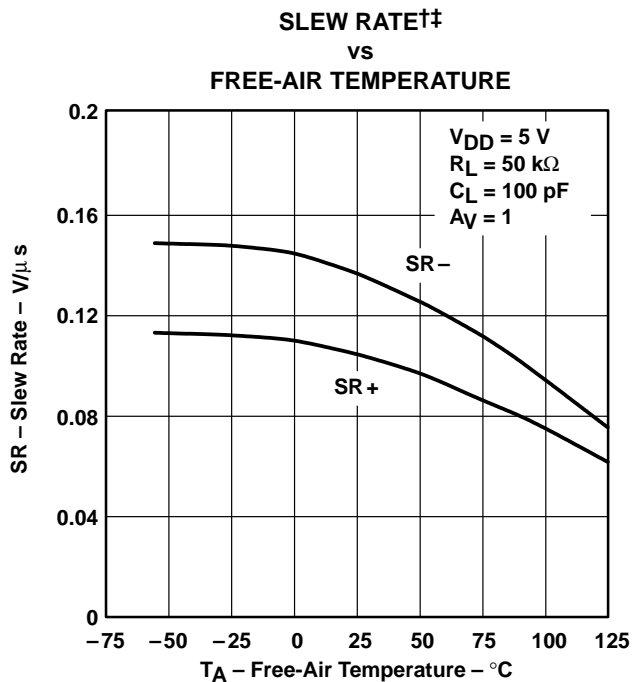

† Data at high and low temperatures are applicable only within the rated operating free-air temperature ranges of the various devices.

‡ For curves where $V_{DD} = 5\text{ V}$, all loads are referenced to 2.5 V.

TYPICAL CHARACTERISTICS

VOLTAGE-FOLLOWER LARGE-SIGNAL PULSE RESPONSE

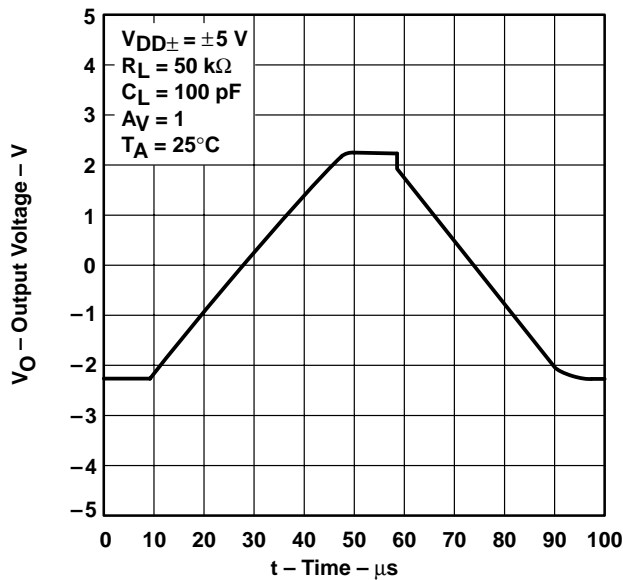

Figure 44

INVERTING SMALL-SIGNAL PULSE RESPONSE†

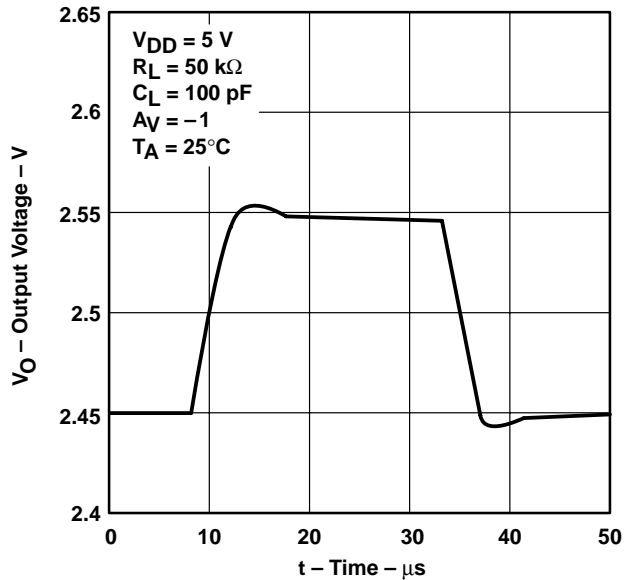

Figure 45

INVERTING SMALL-SIGNAL PULSE RESPONSE



Figure 46

VOLTAGE-FOLLOWER SMALL-SIGNAL PULSE RESPONSE†

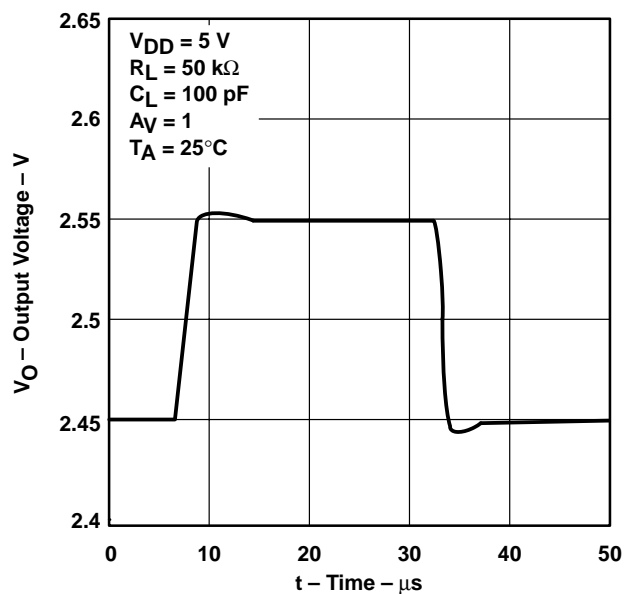

Figure 47

† For curves where $V_{DD} = 5$ V, all loads are referenced to 2.5 V.

TYPICAL CHARACTERISTICS



Figure 48

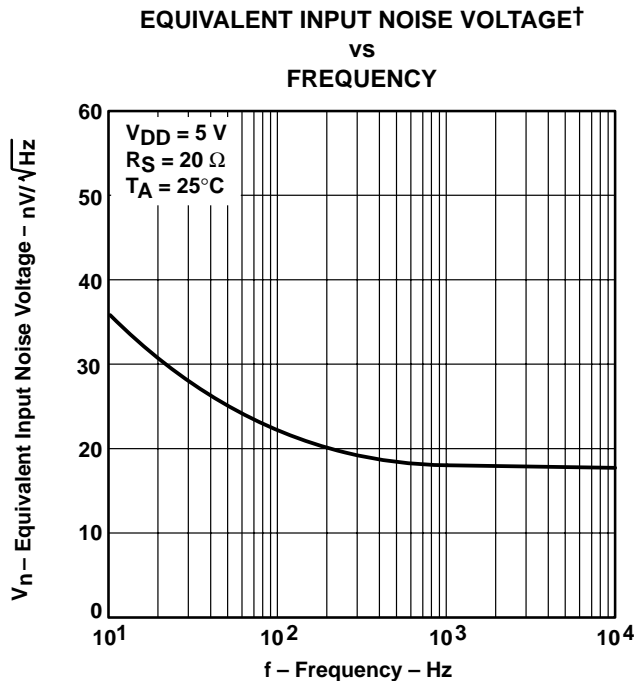

Figure 49



Figure 50

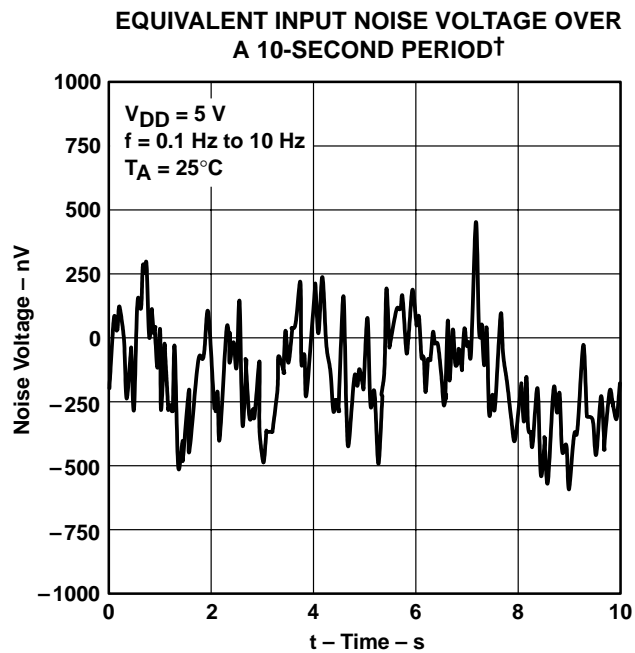

Figure 51

† For curves where $V_{DD} = 5 \text{ V}$, all loads are referenced to 2.5 V.

TYPICAL CHARACTERISTICS

**INTEGRATED NOISE VOLTAGE
 VS
 FREQUENCY**

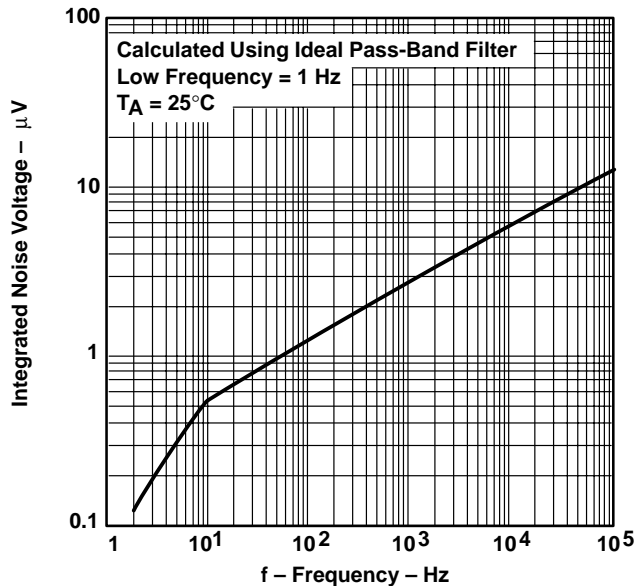

Figure 52

**TOTAL HARMONIC DISTORTION PLUS NOISE†
 VS
 FREQUENCY**

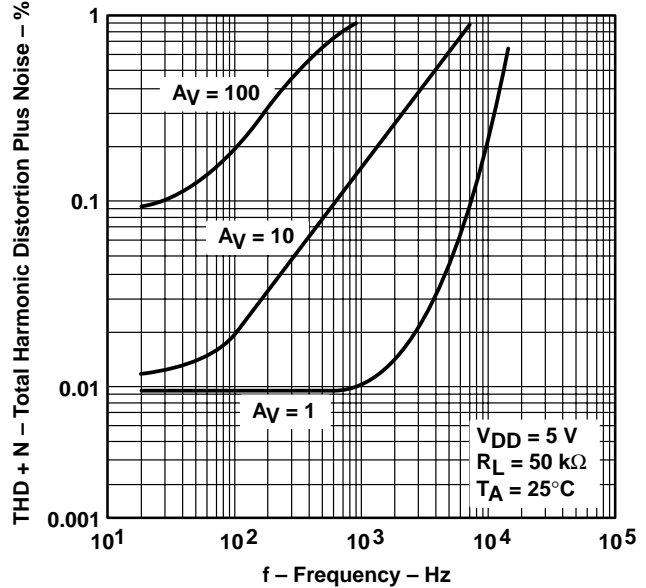

Figure 53

**GAIN-BANDWIDTH PRODUCT‡
 VS
 FREE-AIR TEMPERATURE**

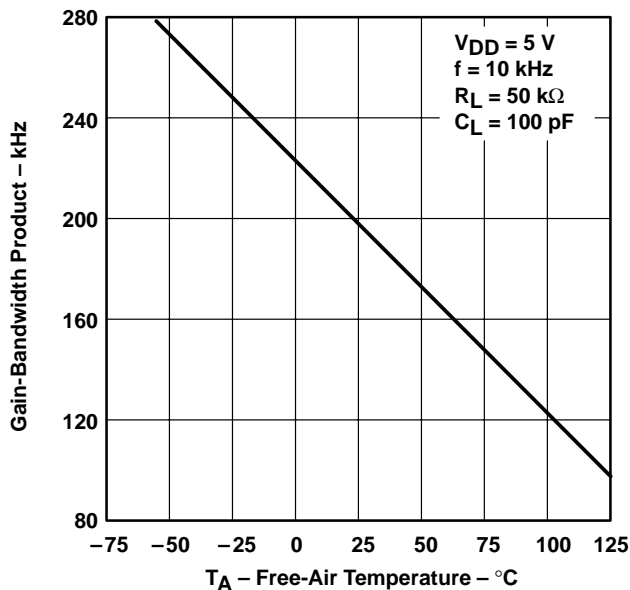

Figure 54

**GAIN-BANDWIDTH PRODUCT
 VS
 SUPPLY VOLTAGE**

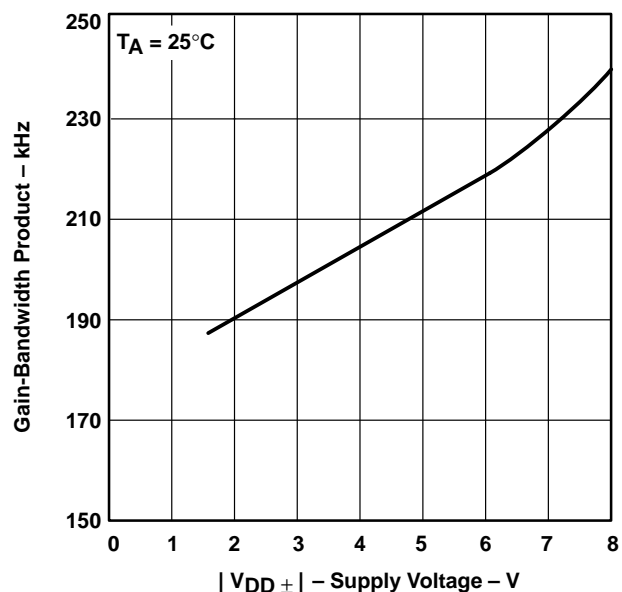

Figure 55

† For curves where $V_{DD} = 5\text{ V}$, all loads are referenced to 2.5 V .

‡ Data at high and low temperatures are applicable only within the rated operating free-air temperature ranges of the various devices.

TYPICAL CHARACTERISTICS



Figure 56

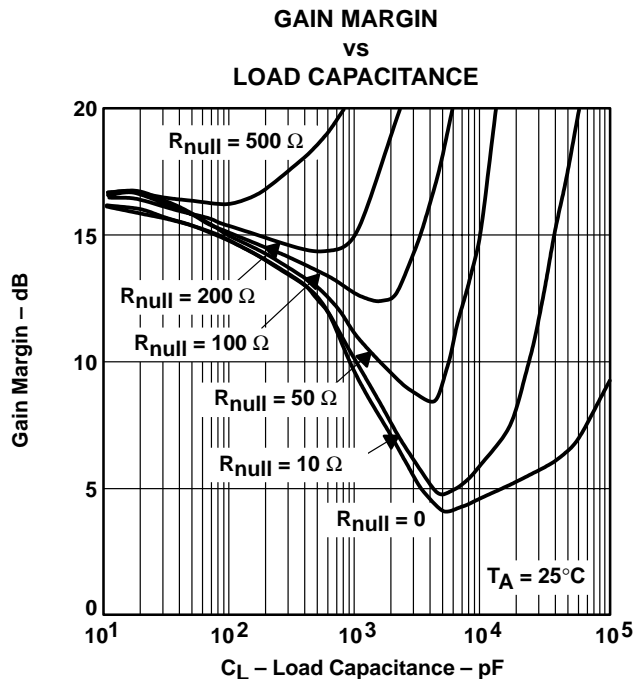

Figure 57

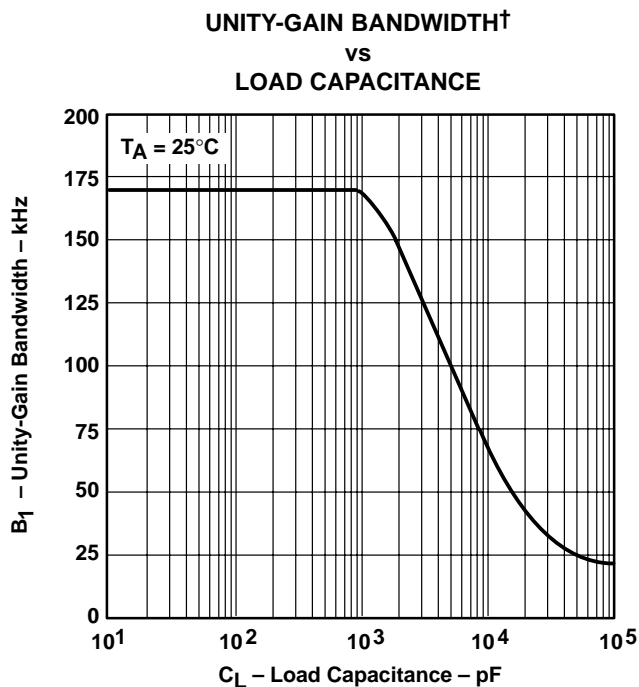

Figure 58

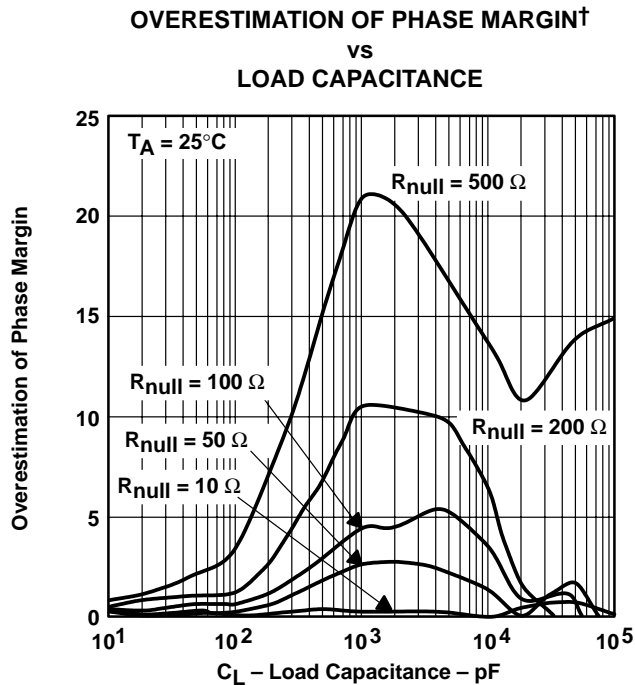

Figure 59

† See application information

APPLICATION INFORMATION

driving large capacitive loads

The TLC225x is designed to drive larger capacitive loads than most CMOS operational amplifiers. Figure 56 and Figure 57 illustrate its ability to drive loads up to 1000 pF while maintaining good gain and phase margins ($R_{null} = 0$).

A smaller series resistor (R_{null}) at the output of the device (see Figure 60) improves the gain and phase margins when driving large capacitive loads. Figure 56 and Figure 57 show the effects of adding series resistances of 10 Ω , 50 Ω , 100 Ω , 200 Ω , and 500 Ω . The addition of this series resistor has two effects: the first is that it adds a zero to the transfer function and the second is that it reduces the frequency of the pole associated with the output load in the transfer function.

The zero introduced to the transfer function is equal to the series resistance times the load capacitance. To calculate the improvement in phase margin, equation 1 can be used.

$$\Delta\phi_{m1} = \tan^{-1} \left(2 \times \pi \times \text{UGBW} \times R_{null} \times C_L \right) \tag{1}$$

Where :

- $\Delta\phi_{m1}$ = Improvement in phase margin
- UGBW = Unity-gain bandwidth frequency
- R_{null} = Output series resistance
- C_L = Load capacitance

The unity-gain bandwidth (UGBW) frequency decreases as the capacitive load increases (see Figure 58). To use equation 1, UGBW must be approximated from Figure 58.

Using equation 1 alone overestimates the improvement in phase margin, as illustrated in Figure 59. The overestimation is caused by the decrease in the frequency of the pole associated with the load, thus providing additional phase shift and reducing the overall improvement in phase margin.

Using Figure 60, with equation 1 enables the designer to choose the appropriate output series resistance to optimize the design of circuits driving large capacitance loads.

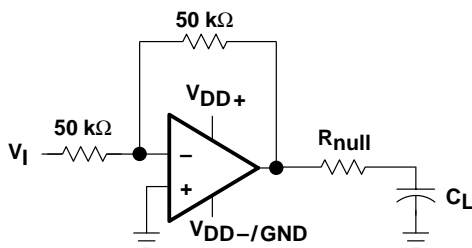

Figure 60. Series-Resistance Circuit

PACKAGING INFORMATION

| Orderable Device | Status (1) | Package Type | Package Drawing | Pins | Package Qty | Eco Plan (2) | Lead/Ball Finish (6) | MSL Peak Temp (3) | Op Temp (°C) | Device Marking (4/5) | Samples |
|------------------|---------------|--------------|--------------------|------|----------------|----------------------------|-------------------------|----------------------|--------------|-----------------------------------------|-------------------------|
| 5962-9564001NXD | OBSOLETE | SOIC | D | 8 | | TBD | Call TI | Call TI | -55 to 125 | Q2252M | |
| 5962-9564001NXDR | OBSOLETE | SOIC | D | 8 | | TBD | Call TI | Call TI | -55 to 125 | Q2252M | |
| 5962-9564001Q2A | ACTIVE | LCCC | FK | 20 | 1 | TBD | POST-PLATE | N / A for Pkg Type | -55 to 125 | 5962- 9564001Q2A TLC2252 MFKB | Samples |
| 5962-9564001QHA | ACTIVE | CFP | U | 10 | 1 | TBD | A42 | N / A for Pkg Type | -55 to 125 | 9564001QHA TLC2252M | Samples |
| 5962-9564001QPA | ACTIVE | CDIP | JG | 8 | 1 | TBD | A42 | N / A for Pkg Type | -55 to 125 | 9564001QPA TLC2252M | Samples |
| 5962-9564002NYDR | OBSOLETE | SOIC | D | 14 | | TBD | Call TI | Call TI | | QTLC2254M | |
| 5962-9564002Q2A | ACTIVE | LCCC | FK | 20 | 1 | TBD | POST-PLATE | N / A for Pkg Type | -55 to 125 | 5962- 9564002Q2A TLC2254 MFKB | Samples |
| 5962-9564002QCA | OBSOLETE | CDIP | J | 14 | | TBD | Call TI | Call TI | -55 to 125 | 5962-9564002QC A TLC2254MJB | |
| 5962-9564002QDA | ACTIVE | CFP | W | 14 | 1 | TBD | A42 | N / A for Pkg Type | -55 to 125 | 5962-9564002QD A TLC2254MWB | Samples |
| 5962-9564003NXD | ACTIVE | SOIC | D | 8 | 2500 | Green (RoHS & no Sb/Br) | CU NIPDAU | Level-1-260C-UNLIM | -55 to 125 | Q2252A | Samples |
| 5962-9564003NXDR | ACTIVE | SOIC | D | 8 | 2500 | Green (RoHS & no Sb/Br) | CU NIPDAU | Level-1-260C-UNLIM | -55 to 125 | Q2252A | Samples |
| 5962-9564003Q2A | ACTIVE | LCCC | FK | 20 | 1 | TBD | POST-PLATE | N / A for Pkg Type | -55 to 125 | 5962- 9564003Q2A TLC2252 AMFKB | Samples |
| 5962-9564003QHA | ACTIVE | CFP | U | 10 | 1 | TBD | A42 | N / A for Pkg Type | -55 to 125 | 9564003QHA TLC2252AM | Samples |
| 5962-9564003QPA | ACTIVE | CDIP | JG | 8 | 1 | TBD | A42 | N / A for Pkg Type | -55 to 125 | 9564003QPA TLC2252AM | Samples |
| 5962-9564004NYDR | OBSOLETE | SOIC | D | 14 | | TBD | Call TI | Call TI | | Q2254AM | |

| Orderable Device | Status (1) | Package Type | Package Drawing | Pins | Package Qty | Eco Plan (2) | Lead/Ball Finish (6) | MSL Peak Temp (3) | Op Temp (°C) | Device Marking (4/5) | Samples |
|------------------|---------------|--------------|-----------------|------|-------------|-------------------------|-------------------------|----------------------|--------------|-------------------------------------|-------------------------|
| 5962-9564004Q2A | ACTIVE | LCCC | FK | 20 | 1 | TBD | POST-PLATE | N / A for Pkg Type | -55 to 125 | 5962-9564004Q2A TLC2254 AMFKB | Samples |
| 5962-9564004QCA | OBSOLETE | CDIP | J | 14 | | TBD | Call TI | Call TI | -55 to 125 | 5962-9564004QC A TLC2254AMJB | |
| 5962-9564004QDA | ACTIVE | CFP | W | 14 | 1 | TBD | A42 | N / A for Pkg Type | -55 to 125 | 5962-9564004QD A TLC2254AMWB | Samples |
| TLC2252AID | ACTIVE | SOIC | D | 8 | 75 | Green (RoHS & no Sb/Br) | CU NIPDAU | Level-1-260C-UNLIM | | 2252AI | Samples |
| TLC2252AIDG4 | ACTIVE | SOIC | D | 8 | 75 | Green (RoHS & no Sb/Br) | CU NIPDAU | Level-1-260C-UNLIM | | 2252AI | Samples |
| TLC2252AIDR | ACTIVE | SOIC | D | 8 | 2500 | Green (RoHS & no Sb/Br) | CU NIPDAU | Level-1-260C-UNLIM | | 2252AI | Samples |
| TLC2252AIDRG4 | ACTIVE | SOIC | D | 8 | 2500 | Green (RoHS & no Sb/Br) | CU NIPDAU | Level-1-260C-UNLIM | | 2252AI | Samples |
| TLC2252AIP | ACTIVE | PDIP | P | 8 | 50 | Pb-Free (RoHS) | CU NIPDAU | N / A for Pkg Type | | TLC2252AI | Samples |
| TLC2252AIPE4 | ACTIVE | PDIP | P | 8 | 50 | Pb-Free (RoHS) | CU NIPDAU | N / A for Pkg Type | | TLC2252AI | Samples |
| TLC2252AIPW | ACTIVE | TSSOP | PW | 8 | 150 | Green (RoHS & no Sb/Br) | CU NIPDAU | Level-1-260C-UNLIM | | Y2252A | Samples |
| TLC2252AIPWLE | OBSOLETE | TSSOP | PW | 8 | | TBD | Call TI | Call TI | | | |
| TLC2252AIPWR | ACTIVE | TSSOP | PW | 8 | 2000 | Green (RoHS & no Sb/Br) | CU NIPDAU | Level-1-260C-UNLIM | | Y2252A | Samples |
| TLC2252AIPWRG4 | ACTIVE | TSSOP | PW | 8 | 2000 | Green (RoHS & no Sb/Br) | CU NIPDAU | Level-1-260C-UNLIM | | Y2252A | Samples |
| TLC2252AMFKB | ACTIVE | LCCC | FK | 20 | 1 | TBD | POST-PLATE | N / A for Pkg Type | -55 to 125 | 5962-9564003Q2A TLC2252 AMFKB | Samples |
| TLC2252AMJGB | ACTIVE | CDIP | JG | 8 | 1 | TBD | A42 | N / A for Pkg Type | -55 to 125 | 9564003QPA TLC2252AM | Samples |
| TLC2252AMUB | ACTIVE | CFP | U | 10 | 1 | TBD | A42 | N / A for Pkg Type | -55 to 125 | 9564003QHA TLC2252AM | Samples |

| Orderable Device | Status (1) | Package Type | Package Drawing | Pins | Package Qty | Eco Plan (2) | Lead/Ball Finish (6) | MSL Peak Temp (3) | Op Temp (°C) | Device Marking (4/5) | Samples |
|------------------|---------------|--------------|--------------------|------|----------------|----------------------------|-------------------------|----------------------|--------------|--------------------------------|-------------------------|
| TLC2252AQDR | ACTIVE | SOIC | D | 8 | 2500 | Green (RoHS & no Sb/Br) | CU NIPDAU | Level-1-260C-UNLIM | -40 to 125 | C2252A | Samples |
| TLC2252AQDRG4 | ACTIVE | SOIC | D | 8 | 2500 | Green (RoHS & no Sb/Br) | CU NIPDAU | Level-1-260C-UNLIM | | C2252A | Samples |
| TLC2252CD | ACTIVE | SOIC | D | 8 | 75 | Green (RoHS & no Sb/Br) | CU NIPDAU | Level-1-260C-UNLIM | 0 to 70 | 2252C | Samples |
| TLC2252CDG4 | ACTIVE | SOIC | D | 8 | 75 | Green (RoHS & no Sb/Br) | CU NIPDAU | Level-1-260C-UNLIM | 0 to 70 | 2252C | Samples |
| TLC2252CDR | ACTIVE | SOIC | D | 8 | 2500 | Green (RoHS & no Sb/Br) | CU NIPDAU | Level-1-260C-UNLIM | 0 to 70 | 2252C | Samples |
| TLC2252CDRG4 | ACTIVE | SOIC | D | 8 | 2500 | Green (RoHS & no Sb/Br) | CU NIPDAU | Level-1-260C-UNLIM | 0 to 70 | 2252C | Samples |
| TLC2252CP | ACTIVE | PDIP | P | 8 | 50 | Pb-Free (RoHS) | CU NIPDAU | N / A for Pkg Type | 0 to 70 | TLC2252CP | Samples |
| TLC2252CPW | ACTIVE | TSSOP | PW | 8 | 150 | Green (RoHS & no Sb/Br) | CU NIPDAU | Level-1-260C-UNLIM | 0 to 70 | P2252 | Samples |
| TLC2252CPWG4 | ACTIVE | TSSOP | PW | 8 | 150 | Green (RoHS & no Sb/Br) | CU NIPDAU | Level-1-260C-UNLIM | 0 to 70 | P2252 | Samples |
| TLC2252CPWLE | OBSOLETE | TSSOP | PW | 8 | | TBD | Call TI | Call TI | 0 to 70 | | |
| TLC2252CPWR | ACTIVE | TSSOP | PW | 8 | 2000 | Green (RoHS & no Sb/Br) | CU NIPDAU | Level-1-260C-UNLIM | 0 to 70 | P2252 | Samples |
| TLC2252CPWRG4 | ACTIVE | TSSOP | PW | 8 | 2000 | Green (RoHS & no Sb/Br) | CU NIPDAU | Level-1-260C-UNLIM | 0 to 70 | P2252 | Samples |
| TLC2252ID | ACTIVE | SOIC | D | 8 | 75 | Green (RoHS & no Sb/Br) | CU NIPDAU | Level-1-260C-UNLIM | -40 to 125 | 2252I | Samples |
| TLC2252IDG4 | ACTIVE | SOIC | D | 8 | 75 | Green (RoHS & no Sb/Br) | CU NIPDAU | Level-1-260C-UNLIM | -40 to 125 | 2252I | Samples |
| TLC2252IDR | ACTIVE | SOIC | D | 8 | 2500 | Green (RoHS & no Sb/Br) | CU NIPDAU | Level-1-260C-UNLIM | -40 to 125 | 2252I | Samples |
| TLC2252IDRG4 | ACTIVE | SOIC | D | 8 | 2500 | Green (RoHS & no Sb/Br) | CU NIPDAU | Level-1-260C-UNLIM | -40 to 125 | 2252I | Samples |
| TLC2252IP | ACTIVE | PDIP | P | 8 | 50 | Pb-Free (RoHS) | CU NIPDAU | N / A for Pkg Type | -40 to 125 | TLC2252IP | Samples |
| TLC2252MFKB | ACTIVE | LCCC | FK | 20 | 1 | TBD | POST-PLATE | N / A for Pkg Type | -55 to 125 | 5962- 9564001Q2A TLC2252 | Samples |

| Orderable Device | Status (1) | Package Type | Package Drawing | Pins | Package Qty | Eco Plan (2) | Lead/Ball Finish (6) | MSL Peak Temp (3) | Op Temp (°C) | Device Marking (4/5) | Samples |
|------------------|---------------|--------------|-----------------|------|-------------|----------------------------|-------------------------|----------------------|--------------|-----------------------------------------|-------------------------|
| | | | | | | | | | | MFKB | |
| TLC2252MJGB | ACTIVE | CDIP | JG | 8 | 1 | TBD | A42 | N / A for Pkg Type | -55 to 125 | 9564001QPA TLC2252M | Samples |
| TLC2252MUB | ACTIVE | CFP | U | 10 | 1 | TBD | A42 | N / A for Pkg Type | -55 to 125 | 9564001QHA TLC2252M | Samples |
| TLC2254AID | ACTIVE | SOIC | D | 14 | 50 | Green (RoHS & no Sb/Br) | CU NIPDAU | Level-1-260C-UNLIM | | 2254AI | Samples |
| TLC2254AIDG4 | ACTIVE | SOIC | D | 14 | 50 | Green (RoHS & no Sb/Br) | CU NIPDAU | Level-1-260C-UNLIM | | 2254AI | Samples |
| TLC2254AIDR | ACTIVE | SOIC | D | 14 | 2500 | Green (RoHS & no Sb/Br) | CU NIPDAU | Level-1-260C-UNLIM | | 2254AI | Samples |
| TLC2254AIDRG4 | ACTIVE | SOIC | D | 14 | 2500 | Green (RoHS & no Sb/Br) | CU NIPDAU | Level-1-260C-UNLIM | | 2254AI | Samples |
| TLC2254AIN | ACTIVE | PDIP | N | 14 | 25 | Pb-Free (RoHS) | CU NIPDAU | N / A for Pkg Type | | TLC2254AIN | Samples |
| TLC2254AIPW | ACTIVE | TSSOP | PW | 14 | 90 | Green (RoHS & no Sb/Br) | CU NIPDAU | Level-1-260C-UNLIM | | Y2254A | Samples |
| TLC2254AIPWLE | OBSOLETE | TSSOP | PW | 14 | | TBD | Call TI | Call TI | | | |
| TLC2254AIPWR | ACTIVE | TSSOP | PW | 14 | 2000 | Green (RoHS & no Sb/Br) | CU NIPDAU | Level-1-260C-UNLIM | | Y2254A | Samples |
| TLC2254AIPWRG4 | ACTIVE | TSSOP | PW | 14 | 2000 | Green (RoHS & no Sb/Br) | CU NIPDAU | Level-1-260C-UNLIM | | Y2254A | Samples |
| TLC2254AMFKB | ACTIVE | LCCC | FK | 20 | 1 | TBD | POST-PLATE | N / A for Pkg Type | -55 to 125 | 5962- 9564004Q2A TLC2254 AMFKB | Samples |
| TLC2254AMJB | OBSOLETE | CDIP | J | 14 | | TBD | Call TI | Call TI | -55 to 125 | 5962-9564004QC A TLC2254AMJB | |
| TLC2254AMWB | ACTIVE | CFP | W | 14 | 1 | TBD | A42 | N / A for Pkg Type | -55 to 125 | 5962-9564004QD A TLC2254AMWB | Samples |
| TLC2254AQD | ACTIVE | SOIC | D | 14 | 50 | Green (RoHS & no Sb/Br) | CU NIPDAU | Level-1-260C-UNLIM | -40 to 125 | TLC2254A | Samples |
| TLC2254AQDR | ACTIVE | SOIC | D | 14 | 2500 | Green (RoHS & no Sb/Br) | CU NIPDAU | Level-1-260C-UNLIM | -40 to 125 | TLC2254A | Samples |

| Orderable Device | Status (1) | Package Type | Package Drawing | Pins | Package Qty | Eco Plan (2) | Lead/Ball Finish (6) | MSL Peak Temp (3) | Op Temp (°C) | Device Marking (4/5) | Samples |
|------------------|---------------|--------------|-----------------|------|-------------|-------------------------|-------------------------|----------------------|--------------|------------------------------------|-------------------------|
| TLC2254AQDRG4 | ACTIVE | SOIC | D | 14 | 2500 | Green (RoHS & no Sb/Br) | CU NIPDAU | Level-1-260C-UNLIM | | PJ2254A | Samples |
| TLC2254CD | ACTIVE | SOIC | D | 14 | 50 | Green (RoHS & no Sb/Br) | CU NIPDAU Call TI | Level-1-260C-UNLIM | 0 to 70 | TLC2254C | Samples |
| TLC2254CDG4 | ACTIVE | SOIC | D | 14 | 50 | Green (RoHS & no Sb/Br) | Call TI | Level-1-260C-UNLIM | 0 to 70 | TLC2254C | Samples |
| TLC2254CDR | ACTIVE | SOIC | D | 14 | 2500 | Green (RoHS & no Sb/Br) | CU NIPDAU | Level-1-260C-UNLIM | 0 to 70 | TLC2254C | Samples |
| TLC2254CDRG4 | ACTIVE | SOIC | D | 14 | 2500 | Green (RoHS & no Sb/Br) | CU NIPDAU | Level-1-260C-UNLIM | 0 to 70 | TLC2254C | Samples |
| TLC2254CN | ACTIVE | PDIP | N | 14 | 25 | Pb-Free (RoHS) | CU NIPDAU | N / A for Pkg Type | 0 to 70 | TLC2254CN | Samples |
| TLC2254CPW | ACTIVE | TSSOP | PW | 14 | 90 | Green (RoHS & no Sb/Br) | CU NIPDAU | Level-1-260C-UNLIM | 0 to 70 | P2254 | Samples |
| TLC2254CPWG4 | ACTIVE | TSSOP | PW | 14 | 90 | Green (RoHS & no Sb/Br) | CU NIPDAU | Level-1-260C-UNLIM | 0 to 70 | P2254 | Samples |
| TLC2254CPWLE | OBSOLETE | TSSOP | PW | 14 | | TBD | Call TI | Call TI | 0 to 70 | | |
| TLC2254CPWR | ACTIVE | TSSOP | PW | 14 | 2000 | Green (RoHS & no Sb/Br) | CU NIPDAU | Level-1-260C-UNLIM | 0 to 70 | P2254 | Samples |
| TLC2254CPWRG4 | ACTIVE | TSSOP | PW | 14 | 2000 | Green (RoHS & no Sb/Br) | CU NIPDAU | Level-1-260C-UNLIM | 0 to 70 | P2254 | Samples |
| TLC2254ID | ACTIVE | SOIC | D | 14 | 50 | Green (RoHS & no Sb/Br) | CU NIPDAU | Level-1-260C-UNLIM | | TLC2254I | Samples |
| TLC2254IDG4 | ACTIVE | SOIC | D | 14 | 50 | Green (RoHS & no Sb/Br) | CU NIPDAU | Level-1-260C-UNLIM | | TLC2254I | Samples |
| TLC2254IDR | ACTIVE | SOIC | D | 14 | 2500 | Green (RoHS & no Sb/Br) | CU NIPDAU | Level-1-260C-UNLIM | | TLC2254I | Samples |
| TLC2254IDRG4 | ACTIVE | SOIC | D | 14 | 2500 | Green (RoHS & no Sb/Br) | CU NIPDAU | Level-1-260C-UNLIM | | TLC2254I | Samples |
| TLC2254IN | ACTIVE | PDIP | N | 14 | 25 | Pb-Free (RoHS) | CU NIPDAU | N / A for Pkg Type | | TLC2254IN | Samples |
| TLC2254MFKB | ACTIVE | LCCC | FK | 20 | 1 | TBD | POST-PLATE | N / A for Pkg Type | -55 to 125 | 5962-9564002Q2A TLC2254 MFKB | Samples |
| TLC2254MJB | OBSOLETE | CDIP | J | 14 | | TBD | Call TI | Call TI | -55 to 125 | 5962-9564002QC | |

| Orderable Device | Status (1) | Package Type | Package Drawing | Pins | Package Qty | Eco Plan (2) | Lead/Ball Finish (6) | MSL Peak Temp (3) | Op Temp (°C) | Device Marking (4/5) | Samples |
|------------------|---------------|--------------|-----------------|------|-------------|-----------------|-------------------------|----------------------|--------------|-----------------------------------|---------|
| | | | | | | | | | | A TLC2254MJB | |
| TLC2254MWB | ACTIVE | CFP | W | 14 | 1 | TBD | A42 | N / A for Pkg Type | -55 to 125 | 5962-9564002QD A TLC2254MWB | Samples |
| TLC2254QD | OBSOLETE | SOIC | D | 14 | | TBD | Call TI | Call TI | -40 to 125 | TLC2254 | |
| TLC2254QDR | OBSOLETE | SOIC | D | 14 | | TBD | Call TI | Call TI | -40 to 125 | | |

(1) The marketing status values are defined as follows:

ACTIVE: Product device recommended for new designs.

LIFEBUY: TI has announced that the device will be discontinued, and a lifetime-buy period is in effect.

NRND: Not recommended for new designs. Device is in production to support existing customers, but TI does not recommend using this part in a new design.

PREVIEW: Device has been announced but is not in production. Samples may or may not be available.

OBSOLETE: TI has discontinued the production of the device.

(2) Eco Plan - The planned eco-friendly classification: Pb-Free (RoHS), Pb-Free (RoHS Exempt), or Green (RoHS & no Sb/Br) - please check <http://www.ti.com/productcontent> for the latest availability information and additional product content details.

TBD: The Pb-Free/Green conversion plan has not been defined.

Pb-Free (RoHS): TI's terms "Lead-Free" or "Pb-Free" mean semiconductor products that are compatible with the current RoHS requirements for all 6 substances, including the requirement that lead not exceed 0.1% by weight in homogeneous materials. Where designed to be soldered at high temperatures, TI Pb-Free products are suitable for use in specified lead-free processes.

Pb-Free (RoHS Exempt): This component has a RoHS exemption for either 1) lead-based flip-chip solder bumps used between the die and package, or 2) lead-based die adhesive used between the die and leadframe. The component is otherwise considered Pb-Free (RoHS compatible) as defined above.

Green (RoHS & no Sb/Br): TI defines "Green" to mean Pb-Free (RoHS compatible), and free of Bromine (Br) and Antimony (Sb) based flame retardants (Br or Sb do not exceed 0.1% by weight in homogeneous material)

(3) MSL, Peak Temp. - The Moisture Sensitivity Level rating according to the JEDEC industry standard classifications, and peak solder temperature.

(4) There may be additional marking, which relates to the logo, the lot trace code information, or the environmental category on the device.

(5) Multiple Device Markings will be inside parentheses. Only one Device Marking contained in parentheses and separated by a "-" will appear on a device. If a line is indented then it is a continuation of the previous line and the two combined represent the entire Device Marking for that device.

(6) Lead/Ball Finish - Orderable Devices may have multiple material finish options. Finish options are separated by a vertical ruled line. Lead/Ball Finish values may wrap to two lines if the finish value exceeds the maximum column width.

Important Information and Disclaimer: The information provided on this page represents TI's knowledge and belief as of the date that it is provided. TI bases its knowledge and belief on information provided by third parties, and makes no representation or warranty as to the accuracy of such information. Efforts are underway to better integrate information from third parties. TI has taken and

continues to take reasonable steps to provide representative and accurate information but may not have conducted destructive testing or chemical analysis on incoming materials and chemicals. TI and TI suppliers consider certain information to be proprietary, and thus CAS numbers and other limited information may not be available for release.

In no event shall TI's liability arising out of such information exceed the total purchase price of the TI part(s) at issue in this document sold by TI to Customer on an annual basis.

OTHER QUALIFIED VERSIONS OF TLC2252, TLC2252A, TLC2252AM, TLC2252M, TLC2254, TLC2254A, TLC2254AM, TLC2254M :

- Catalog: [TLC2252A](#), [TLC2252](#), [TLC2254A](#), [TLC2254](#)
- Automotive: [TLC2252-Q1](#), [TLC2252A-Q1](#), [TLC2252A-Q1](#), [TLC2252-Q1](#), [TLC2254-Q1](#), [TLC2254A-Q1](#), [TLC2254A-Q1](#), [TLC2254-Q1](#)
- Enhanced Product: [TLC2252-EP](#), [TLC2252A-EP](#), [TLC2252A-EP](#), [TLC2252-EP](#), [TLC2254-EP](#), [TLC2254A-EP](#), [TLC2254A-EP](#), [TLC2254-EP](#)
- Military: [TLC2252M](#), [TLC2252AM](#), [TLC2254M](#), [TLC2254AM](#)

NOTE: Qualified Version Definitions:

- Catalog - TI's standard catalog product
- Automotive - Q100 devices qualified for high-reliability automotive applications targeting zero defects
- Enhanced Product - Supports Defense, Aerospace and Medical Applications
- Military - QML certified for Military and Defense Applications

TAPE AND REEL INFORMATION

QUADRANT ASSIGNMENTS FOR PIN 1 ORIENTATION IN TAPE

*All dimensions are nominal

| Device | Package Type | Package Drawing | Pins | SPQ | Reel Diameter (mm) | Reel Width W1 (mm) | A0 (mm) | B0 (mm) | K0 (mm) | P1 (mm) | W (mm) | Pin1 Quadrant |
|------------------|--------------|-----------------|------|------|--------------------|--------------------|---------|---------|---------|---------|--------|---------------|
| 5962-9564003NXDR | SOIC | D | 8 | 2500 | 330.0 | 12.4 | 6.4 | 5.2 | 2.1 | 8.0 | 12.0 | Q1 |
| TLC2252AIDR | SOIC | D | 8 | 2500 | 330.0 | 12.4 | 6.4 | 5.2 | 2.1 | 8.0 | 12.0 | Q1 |
| TLC2252AIPWR | TSSOP | PW | 8 | 2000 | 330.0 | 12.4 | 7.0 | 3.6 | 1.6 | 8.0 | 12.0 | Q1 |
| TLC2252CDR | SOIC | D | 8 | 2500 | 330.0 | 12.4 | 6.4 | 5.2 | 2.1 | 8.0 | 12.0 | Q1 |
| TLC2252CPWR | TSSOP | PW | 8 | 2000 | 330.0 | 12.4 | 7.0 | 3.6 | 1.6 | 8.0 | 12.0 | Q1 |
| TLC2252IDR | SOIC | D | 8 | 2500 | 330.0 | 12.4 | 6.4 | 5.2 | 2.1 | 8.0 | 12.0 | Q1 |
| TLC2254AIDR | SOIC | D | 14 | 2500 | 330.0 | 16.4 | 6.5 | 9.0 | 2.1 | 8.0 | 16.0 | Q1 |
| TLC2254AIPWR | TSSOP | PW | 14 | 2000 | 330.0 | 12.4 | 6.9 | 5.6 | 1.6 | 8.0 | 12.0 | Q1 |
| TLC2254AQDR | SOIC | D | 14 | 2500 | 330.0 | 16.4 | 6.5 | 9.0 | 2.1 | 8.0 | 16.0 | Q1 |
| TLC2254CDR | SOIC | D | 14 | 2500 | 330.0 | 16.4 | 6.5 | 9.0 | 2.1 | 8.0 | 16.0 | Q1 |
| TLC2254CPWR | TSSOP | PW | 14 | 2000 | 330.0 | 12.4 | 6.9 | 5.6 | 1.6 | 8.0 | 12.0 | Q1 |
| TLC2254IDR | SOIC | D | 14 | 2500 | 330.0 | 16.4 | 6.5 | 9.0 | 2.1 | 8.0 | 16.0 | Q1 |

TAPE AND REEL BOX DIMENSIONS

*All dimensions are nominal

| Device | Package Type | Package Drawing | Pins | SPQ | Length (mm) | Width (mm) | Height (mm) |
|------------------|--------------|-----------------|------|------|-------------|------------|-------------|
| 5962-9564003NXDR | SOIC | D | 8 | 2500 | 367.0 | 367.0 | 35.0 |
| TLC2252AIDR | SOIC | D | 8 | 2500 | 340.5 | 338.1 | 20.6 |
| TLC2252AIPWR | TSSOP | PW | 8 | 2000 | 367.0 | 367.0 | 35.0 |
| TLC2252CDR | SOIC | D | 8 | 2500 | 340.5 | 338.1 | 20.6 |
| TLC2252CPWR | TSSOP | PW | 8 | 2000 | 367.0 | 367.0 | 35.0 |
| TLC2252IDR | SOIC | D | 8 | 2500 | 340.5 | 338.1 | 20.6 |
| TLC2254AIDR | SOIC | D | 14 | 2500 | 367.0 | 367.0 | 38.0 |
| TLC2254AIPWR | TSSOP | PW | 14 | 2000 | 367.0 | 367.0 | 35.0 |
| TLC2254AQDR | SOIC | D | 14 | 2500 | 367.0 | 367.0 | 38.0 |
| TLC2254CDR | SOIC | D | 14 | 2500 | 367.0 | 367.0 | 38.0 |
| TLC2254CPWR | TSSOP | PW | 14 | 2000 | 367.0 | 367.0 | 35.0 |
| TLC2254IDR | SOIC | D | 14 | 2500 | 367.0 | 367.0 | 38.0 |

JG (R-GDIP-T8)

CERAMIC DUAL-IN-LINE



- NOTES: A. All linear dimensions are in inches (millimeters).
 B. This drawing is subject to change without notice.
 C. This package can be hermetically sealed with a ceramic lid using glass frit.
 D. Index point is provided on cap for terminal identification.
 E. Falls within MIL STD 1835 GDIP1-T8

J (R-GDIP-T**)

14 LEADS SHOWN

CERAMIC DUAL IN-LINE PACKAGE



| DIM \ PINS ** | 14 | 16 | 18 | 20 |
|---------------|------------------------|------------------------|------------------------|------------------------|
| A | 0.300 (7,62) BSC | 0.300 (7,62) BSC | 0.300 (7,62) BSC | 0.300 (7,62) BSC |
| B MAX | 0.785 (19,94) | .840 (21,34) | 0.960 (24,38) | 1.060 (26,92) |
| B MIN | — | — | — | — |
| C MAX | 0.300 (7,62) | 0.300 (7,62) | 0.310 (7,87) | 0.300 (7,62) |
| C MIN | 0.245 (6,22) | 0.245 (6,22) | 0.220 (5,59) | 0.245 (6,22) |



4040083/F 03/03

- NOTES:
- A. All linear dimensions are in inches (millimeters).
 - B. This drawing is subject to change without notice.
 - C. This package is hermetically sealed with a ceramic lid using glass frit.
 - D. Index point is provided on cap for terminal identification only on press ceramic glass frit seal only.
 - E. Falls within MIL STD 1835 GDIP1-T14, GDIP1-T16, GDIP1-T18 and GDIP1-T20.

W (R-GDFP-F14)

CERAMIC DUAL FLATPACK



- NOTES:
- A. All linear dimensions are in inches (millimeters).
 - B. This drawing is subject to change without notice.
 - C. This package can be hermetically sealed with a ceramic lid using glass frit.
 - D. Index point is provided on cap for terminal identification only.
 - E. Falls within MIL STD 1835 GDFP1-F14

P (R-PDIP-T8)

PLASTIC DUAL-IN-LINE PACKAGE



- NOTES:
- A. All linear dimensions are in inches (millimeters).
 - B. This drawing is subject to change without notice.
 - C. Falls within JEDEC MS-001 variation BA.

N (R-PDIP-T**)

PLASTIC DUAL-IN-LINE PACKAGE

16 PINS SHOWN



4040049/E 12/2002

- NOTES:
- A. All linear dimensions are in inches (millimeters).
 - B. This drawing is subject to change without notice.
 - $\triangle C$ Falls within JEDEC MS-001, except 18 and 20 pin minimum body length (Dim A).
 - $\triangle D$ The 20 pin end lead shoulder width is a vendor option, either half or full width.

D (R-PDSO-G14)

PLASTIC SMALL OUTLINE



- NOTES:
- A. All linear dimensions are in inches (millimeters).
 - B. This drawing is subject to change without notice.
 -  Body length does not include mold flash, protrusions, or gate burrs. Mold flash, protrusions, or gate burrs shall not exceed 0.006 (0,15) each side.
 -  Body width does not include interlead flash. Interlead flash shall not exceed 0.017 (0,43) each side.
 - E. Reference JEDEC MS-012 variation AB.

D (R-PDSO-G14)

PLASTIC SMALL OUTLINE



- NOTES:
- A. All linear dimensions are in millimeters.
 - B. This drawing is subject to change without notice.
 - C. Publication IPC-7351 is recommended for alternate designs.
 - D. Laser cutting apertures with trapezoidal walls and also rounding corners will offer better paste release. Customers should contact their board assembly site for stencil design recommendations. Refer to IPC-7525 for other stencil recommendations.
 - E. Customers should contact their board fabrication site for solder mask tolerances between and around signal pads.

PW (R-PDSO-G14)

PLASTIC SMALL OUTLINE



- NOTES:
- A. All linear dimensions are in millimeters. Dimensioning and tolerancing per ASME Y14.5M-1994.
 - B. This drawing is subject to change without notice.
 - C. Body length does not include mold flash, protrusions, or gate burrs. Mold flash, protrusions, or gate burrs shall not exceed 0,15 each side.
 - D. Body width does not include interlead flash. Interlead flash shall not exceed 0,25 each side.
 - E. Falls within JEDEC MO-153

PW (R-PDSO-G14)

PLASTIC SMALL OUTLINE



- NOTES:
- All linear dimensions are in millimeters.
 - This drawing is subject to change without notice.
 - Publication IPC-7351 is recommended for alternate designs.
 - Laser cutting apertures with trapezoidal walls and also rounding corners will offer better paste release. Customers should contact their board assembly site for stencil design recommendations. Refer to IPC-7525 for other stencil recommendations.
 - Customers should contact their board fabrication site for solder mask tolerances between and around signal pads.

PW0008A



PACKAGE OUTLINE

TSSOP - 1.2 mm max height

SMALL OUTLINE PACKAGE



4221848/A 02/2015

NOTES:

1. All linear dimensions are in millimeters. Any dimensions in parenthesis are for reference only. Dimensioning and tolerancing per ASME Y14.5M.
2. This drawing is subject to change without notice.
3. This dimension does not include mold flash, protrusions, or gate burrs. Mold flash, protrusions, or gate burrs shall not exceed 0.15 mm per side.
4. This dimension does not include interlead flash. Interlead flash shall not exceed 0.25 mm per side.
5. Reference JEDEC registration MO-153, variation AA.

EXAMPLE BOARD LAYOUT

PW0008A

TSSOP - 1.2 mm max height

SMALL OUTLINE PACKAGE



LAND PATTERN EXAMPLE
SCALE:10X



SOLDER MASK DETAILS
NOT TO SCALE

4221848/A 02/2015

NOTES: (continued)

- 6. Publication IPC-7351 may have alternate designs.
- 7. Solder mask tolerances between and around signal pads can vary based on board fabrication site.

EXAMPLE STENCIL DESIGN

PW0008A

TSSOP - 1.2 mm max height

SMALL OUTLINE PACKAGE



SOLDER PASTE EXAMPLE
BASED ON 0.125 mm THICK STENCIL
SCALE:10X

4221848/A 02/2015

NOTES: (continued)

8. Laser cutting apertures with trapezoidal walls and rounded corners may offer better paste release. IPC-7525 may have alternate design recommendations.
9. Board assembly site may have different recommendations for stencil design.

D (R-PDSO-G8)

PLASTIC SMALL OUTLINE



4211283-2/E 08/12

- NOTES:
- A. All linear dimensions are in millimeters.
 - B. This drawing is subject to change without notice.
 - C. Publication IPC-7351 is recommended for alternate designs.
 - D. Laser cutting apertures with trapezoidal walls and also rounding corners will offer better paste release. Customers should contact their board assembly site for stencil design recommendations. Refer to IPC-7525 for other stencil recommendations.
 - E. Customers should contact their board fabrication site for solder mask tolerances between and around signal pads.

IMPORTANT NOTICE

Texas Instruments Incorporated and its subsidiaries (TI) reserve the right to make corrections, enhancements, improvements and other changes to its semiconductor products and services per JESD46, latest issue, and to discontinue any product or service per JESD48, latest issue. Buyers should obtain the latest relevant information before placing orders and should verify that such information is current and complete. All semiconductor products (also referred to herein as "components") are sold subject to TI's terms and conditions of sale supplied at the time of order acknowledgment.

TI warrants performance of its components to the specifications applicable at the time of sale, in accordance with the warranty in TI's terms and conditions of sale of semiconductor products. Testing and other quality control techniques are used to the extent TI deems necessary to support this warranty. Except where mandated by applicable law, testing of all parameters of each component is not necessarily performed.

TI assumes no liability for applications assistance or the design of Buyers' products. Buyers are responsible for their products and applications using TI components. To minimize the risks associated with Buyers' products and applications, Buyers should provide adequate design and operating safeguards.

TI does not warrant or represent that any license, either express or implied, is granted under any patent right, copyright, mask work right, or other intellectual property right relating to any combination, machine, or process in which TI components or services are used. Information published by TI regarding third-party products or services does not constitute a license to use such products or services or a warranty or endorsement thereof. Use of such information may require a license from a third party under the patents or other intellectual property of the third party, or a license from TI under the patents or other intellectual property of TI.

Reproduction of significant portions of TI information in TI data books or data sheets is permissible only if reproduction is without alteration and is accompanied by all associated warranties, conditions, limitations, and notices. TI is not responsible or liable for such altered documentation. Information of third parties may be subject to additional restrictions.

Resale of TI components or services with statements different from or beyond the parameters stated by TI for that component or service voids all express and any implied warranties for the associated TI component or service and is an unfair and deceptive business practice. TI is not responsible or liable for any such statements.

Buyer acknowledges and agrees that it is solely responsible for compliance with all legal, regulatory and safety-related requirements concerning its products, and any use of TI components in its applications, notwithstanding any applications-related information or support that may be provided by TI. Buyer represents and agrees that it has all the necessary expertise to create and implement safeguards which anticipate dangerous consequences of failures, monitor failures and their consequences, lessen the likelihood of failures that might cause harm and take appropriate remedial actions. Buyer will fully indemnify TI and its representatives against any damages arising out of the use of any TI components in safety-critical applications.

In some cases, TI components may be promoted specifically to facilitate safety-related applications. With such components, TI's goal is to help enable customers to design and create their own end-product solutions that meet applicable functional safety standards and requirements. Nonetheless, such components are subject to these terms.

No TI components are authorized for use in FDA Class III (or similar life-critical medical equipment) unless authorized officers of the parties have executed a special agreement specifically governing such use.

Only those TI components which TI has specifically designated as military grade or "enhanced plastic" are designed and intended for use in military/aerospace applications or environments. Buyer acknowledges and agrees that any military or aerospace use of TI components which have **not** been so designated is solely at the Buyer's risk, and that Buyer is solely responsible for compliance with all legal and regulatory requirements in connection with such use.

TI has specifically designated certain components as meeting ISO/TS16949 requirements, mainly for automotive use. In any case of use of non-designated products, TI will not be responsible for any failure to meet ISO/TS16949.

Products

| | |
|------------------------------|--------------------------------------------------------------------------------------|
| Audio | www.ti.com/audio |
| Amplifiers | amplifier.ti.com |
| Data Converters | dataconverter.ti.com |
| DLP® Products | www.dlp.com |
| DSP | dsp.ti.com |
| Clocks and Timers | www.ti.com/clocks |
| Interface | interface.ti.com |
| Logic | logic.ti.com |
| Power Mgmt | power.ti.com |
| Microcontrollers | microcontroller.ti.com |
| RFID | www.ti-rfid.com |
| OMAP Applications Processors | www.ti.com/omap |
| Wireless Connectivity | www.ti.com/wirelessconnectivity |

Applications

| | |
|-------------------------------|------------------------------------------------------------------------------------------|
| Automotive and Transportation | www.ti.com/automotive |
| Communications and Telecom | www.ti.com/communications |
| Computers and Peripherals | www.ti.com/computers |
| Consumer Electronics | www.ti.com/consumer-apps |
| Energy and Lighting | www.ti.com/energy |
| Industrial | www.ti.com/industrial |
| Medical | www.ti.com/medical |
| Security | www.ti.com/security |
| Space, Avionics and Defense | www.ti.com/space-avionics-defense |
| Video and Imaging | www.ti.com/video |

TI E2E Community

e2e.ti.com