



VPM36-1390

Description:

The toroidal construction inherently reduces stray fields, increases efficiency and minimizes size compared to traditional EI transformers. The addition of a Flux Band further reduces the remaining stray fields. The shield between Primary and Secondary improves safety, reduces common mode signals and minimizes leakage current. Built with a Class F (155°) insulation system. A 140°C self-resetting thermal switch is included in each primary.

Electrical Specifications (@25C)

1. Maximum Power: 50VA
2. Input Voltages: 100, 120, 220, 240VAC, 50/60Hz
3. Output Voltages: 18VAC @ 2.78A or 36VAC CT @ 1.39A
4. Voltage Regulation: 11.5% TYP from full load to no load
5. Temperature Rise: 45°C TYP
6. Hipot: 4000VAC, Primary to Secondary, Primary & Secondary to Shield & mounting surface
7. Efficiency: 89% TYP. @ full load

Agency File:

UL: File E122529, UL 60601-1/(R) 2012 Medical Electrical Equipment – Part 1
 CE: ES 60601-1 (IEC 60601-1:2005, MOD)
 cUL: C22.2 No. 60601-1:14, Medical Electrical Equipment – Part 1
 CB Certified.



Dimensions: Inches (mm)

O.D.	I.D.	HT.*
3.6 (92)	1.2(31)	1.5(38)

*Add 0.188 (3) to the height for mounting hardware

Weight: 0.7Kg

Mounting:

Transformer is provided with one metal mounting plate, two rubber pads, M5 x 45mm bolt, nut, spring and flat washer.

Connections:

Transformer is provided with 8" (203mm) long, 0.25" (6.35mm) 12" (305mm) long, 0.5" (12.7mm) stripped and tinned, stranded UL 1015 lead wire. Primaries are 22AWG, Secondaries are 20AWG, and Shield is 20AWG. **The GRN/YEL shield lead is typically grounded. Do not lift transformer by leads!**

Input Options:

- 100VAC:** Input to Gray & Blue, jumper White & Brown, jumper Blue & Violet.
- 120VAC:** Input to White & Blue, jumper White & Brown, jumper Blue & Violet.
- 220VAC:** Input to Gray & Violet, jumper Blue & Brown
- 240VAC:** Input to White and Violet, jumper Blue & Brown

Output Options:

- 120VAC:** Output from Black & Red, jumper Black & Orange, jumper Red to Yellow
- 240VAC:** Output from Black & Yellow, jumper Red & Orange

Primary and secondary windings are designed to be connected in series or parallel. Windings are not intended to be used independently.

RoHS Compliance: Meets the requirements of 2011/65/EU, known as the RoHS 2 initiative.

* At printing, this document is considered "uncontrolled". Contact Triad Magnetics' website for current version

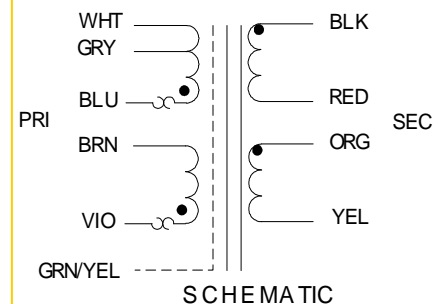
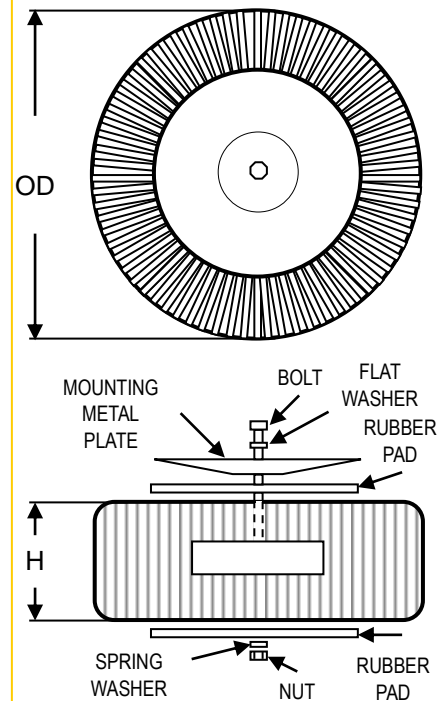

**POWER TRANSFORMER
CHASSIS MOUNT :
TOROIDAL MEDICAL SERIES**

Web: www.TriadMagnetics.com
Phone 951-277-0757
Fax 951-277-2757

460 Harley Knox Blvd.
Perris, California 92571

Publish Date: June 19, 2015