

SPACECRAFT COMPONENTS CORP.

Your Connector Consultant Since 1962

AS50151

# DUST CAPS

## & DUMMY RECEPTACLES

MS25042

MS25043

MS3105



- ▶ Military Approved
- ▶ Special Platings Available
- ▶ Extensive Inventory



**SPACECRAFT**  
COMPONENTS CORP.

# DUST CAPS & DUMMY RECEPTACLES - AS50151

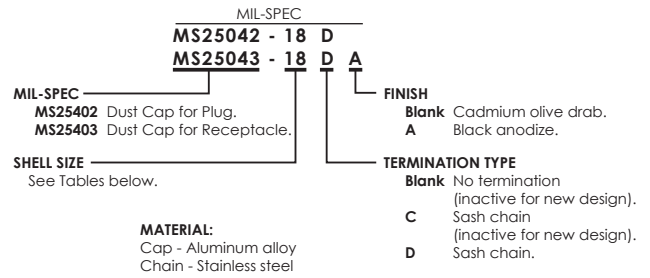
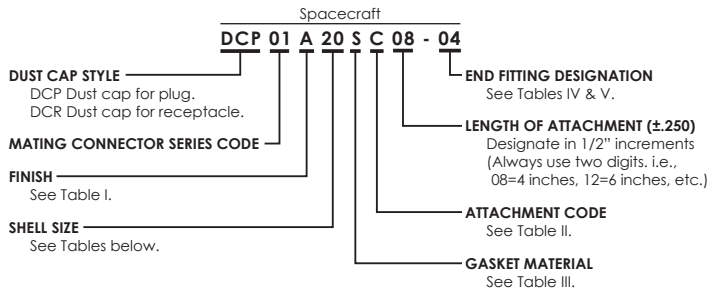

## Dust Cap for Plug

### MS25042 DCP01

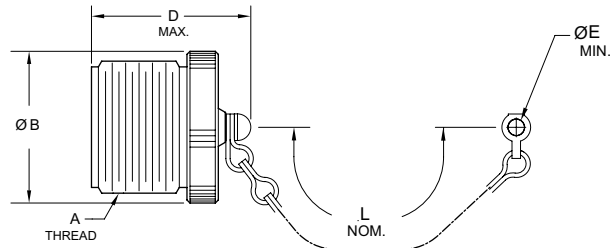

DASH NO.	SHELL SIZE	A THREAD CLASS 2A	B MAX.	D MAX.	E* MIN.	L NOMINAL
8	8S	.500-28 UNEF	.562 [14.27]	.969 [24.61]	.151 [3.84]	4.00 [101.60]
10	10S, 10SL	.625-24 UNEF	.687 [17.45]	.969 [24.61]	.151 [3.84]	4.00 [101.60]
12	12, 12S	.750-20 UNEF	.812 [20.62]	1.156 [29.36]	.151 [3.84]	4.50 [114.30]
14	14, 14S	.875-20 UNEF	.937 [23.80]	1.156 [29.36]	.151 [3.84]	4.50 [114.30]
16	16, 16S	1.000-20 NEF	1.062 [26.97]	1.156 [29.36]	.151 [3.84]	4.50 [114.30]
18	18	1.125-18 UNEF	1.187 [30.15]	1.156 [29.36]	.151 [3.84]	4.50 [114.30]
20	20	1.250-18 UNEF	1.312 [33.32]	1.156 [29.36]	.182 [4.62]	5.00 [127.00]
22	22	1.375-18 UNEF	1.437 [36.50]	1.156 [29.36]	.182 [4.62]	5.00 [127.00]
24	24	1.500-18 UNEF	1.562 [39.67]	1.156 [29.36]	.182 [4.62]	5.50 [139.70]
28	28	1.750-18 UNS	1.812 [46.02]	1.156 [29.36]	.182 [4.62]	7.75 [196.85]
32	32	2.000-18 UNS	2.062 [52.37]	1.156 [29.36]	.213 [5.41]	7.75 [196.85]
36	36	2.250-16 UN	2.312 [58.72]	1.156 [29.36]	.213 [5.41]	7.75 [196.85]
40	40	2.500-16 UN	2.562 [65.07]	1.156 [29.36]	.213 [5.41]	7.75 [196.85]

1. Dimensions in brackets [ ] are in millimeters.

\* "E" dimensions only applicable for MS25042/MS25403. For DCP01/DCP02 caps use end fitting code.

## Dust Cap for Receptacle

### MS25043 DCR01

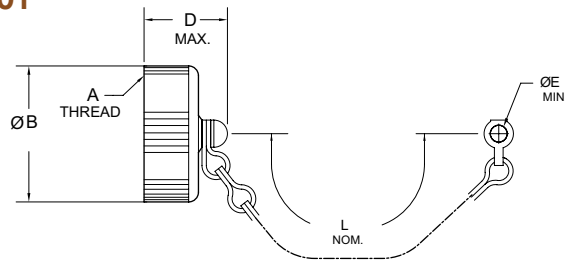

DASH NO.	SHELL SIZE	A THREAD CLASS 2B	B MAX.	D MAX.	E* MIN.	L NOMINAL
8	8S	.500-28 UNEF	.688 [17.48]	.750 [19.05]	.135 [3.43]	4.00 [101.60]
10	10S, 10SL	.625-24 UNEF	.815 [20.70]	.750 [19.05]	.135 [3.43]	4.00 [101.60]
12	12, 12S	.750-20 UNEF	1.000 [25.40]	.750 [19.05]	.135 [3.43]	4.50 [114.30]
14	14, 14S	.875-20 UNEF	1.125 [28.57]	.750 [19.05]	.135 [3.43]	4.50 [114.30]
16	16, 16S	1.000-20 NEF	1.188 [30.18]	.750 [19.05]	.135 [3.43]	4.50 [114.30]
18	18	1.125-18 UNEF	1.344 [34.14]	.750 [19.05]	.135 [3.43]	4.50 [114.30]
20	20	1.250-18 UNEF	1.469 [37.31]	.750 [19.05]	.135 [3.43]	5.00 [127.00]
22	22	1.375-18 UNEF	1.594 [40.49]	.750 [19.05]	.135 [3.43]	5.00 [127.00]
24	24	1.500-18 UNEF	1.719 [43.66]	.750 [19.05]	.166 [4.22]	5.50 [139.70]
28	28	1.750-18 UNS	1.969 [50.01]	.812 [20.62]	.166 [4.22]	7.75 [196.85]
32	32	2.000-18 UNS	2.219 [56.36]	.812 [20.62]	.182 [4.62]	7.75 [196.85]
36	36	2.250-16 UN	2.469 [62.71]	.812 [20.62]	.182 [4.62]	7.75 [196.85]
40	40	2.500-16 UN	2.719 [69.06]	.812 [20.62]	.182 [4.62]	7.75 [196.85]

1. Dimensions in brackets [ ] are in millimeters.

\* "E" dimensions only applicable for MS25042/MS25403. For DCP01/DCP02 caps use end fitting code.

## Dummy Receptacle

### MS3105 DRP01

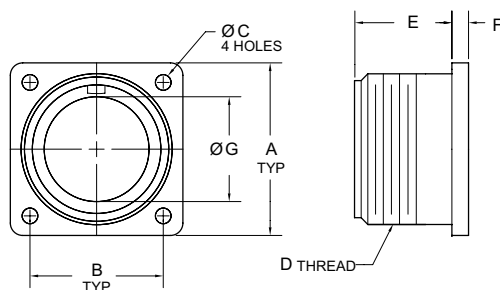
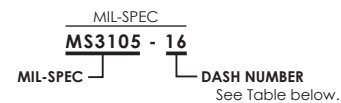
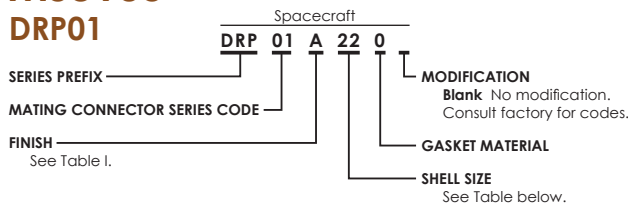

DASH NO. (SHELL SIZE)	A ±.031 [±0.79]	B ±.005 [±0.25]	C +.010 -.005 [+0.25] [-0.13]	D THREAD CLASS 2A	E +.031 -.000 [+0.79] [-0.00]	F
8S	.875 [22.22]	.594 [15.09]	.120 [3.05]	.500-28 UNEF	.562 [14.27]	.156 [3.96]
10S, 10SL	1.000 [25.40]	.719 [18.26]	.120 [3.05]	.625-24 UNEF	.562 [14.27]	.156 [3.96]
12S	1.094 [27.79]	.812 [20.62]	.120 [3.05]	.750-20 UNEF	.562 [14.27]	.156 [3.96]
12	1.094 [27.79]	.812 [20.62]	.120 [3.05]	.750-20 UNEF	.750 [19.05]	.156 [3.96]
14S	1.188 [30.18]	.906 [23.01]	.120 [3.05]	.875-20 UNEF	.562 [14.27]	.156 [3.96]
14	1.188 [30.18]	.906 [23.01]	.120 [3.05]	.875-20 UNEF	.750 [19.05]	.156 [3.96]
16S	1.281 [32.54]	.969 [24.61]	.120 [3.05]	1.000-20 UNEF	.562 [14.27]	.156 [3.96]
16	1.281 [32.54]	.969 [24.61]	.120 [3.05]	1.000-20 UNEF	.750 [19.05]	.156 [3.96]
18	1.375 [34.92]	1.062 [26.97]	.120 [3.05]	1.125-18 UNEF	.750 [19.05]	.203 [5.16]
20	1.500 [38.10]	1.156 [29.36]	.120 [3.05]	1.250-18 UNEF	.750 [19.05]	.203 [5.16]
22	1.625 [41.27]	1.250 [31.75]	.120 [3.05]	1.375-18 UNEF	.750 [19.05]	.203 [5.16]
24	1.750 [44.45]	1.375 [34.92]	.147 [3.73]	1.500-18 UNEF	.812 [20.62]	.203 [5.16]
28	2.000 [50.80]	1.562 [39.67]	.147 [3.73]	1.750-18 UNS	.812 [20.62]	.203 [5.16]
32	2.250 [57.15]	1.750 [44.45]	.173 [4.39]	2.000-16 UNS	.875 [22.22]	.359 [9.12]
36	2.500 [63.50]	1.938 [49.23]	.173 [4.39]	2.250-16 UN	.875 [22.22]	.359 [9.12]
40	2.750 [69.85]	2.188 [55.58]	.173 [4.39]	2.500-16 UN	.875 [22.22]	.359 [9.12]

1. Dimensions in brackets [ ] are in millimeters.



**SPACECRAFT  
COMPONENTS CORP.**

3040 Clayton Street  
North Las Vegas, NV 89032

Phone: 702.851.7600  
Fax: 702.851.7620

Email: salesinfo@spacecraft.com  
Web: www.spacecraft.com

# AS50151 - DUST CAPS & DUMMY RECEPTACLES

SPACECRAFT CODES FOR: } DUST CAP FOR PLUG: **DCP01**  
 DUST CAP FOR RECEPTACLE: **DCR01**  
 DUMMY RECEPTACLE: **DRP01**

**TABLE I. FINISH CODES**  
 CONSULT FACTORY FOR OTHER AVAILABLE FINISHES

Spacecraft Code	Finish	Specification(s)
H	● Anodize, Black	AMS-A-8625, Type II, Class 2
B	● Cadmium Plate, Black	AMS-QQ-P-416, Type II, Class 3
X	● Cadmium Plate, Bright Over Electroless Nickel	AMS-QQ-P-416, Type I, Class 3 ASTMB 733-90, SC2, Type I, Class 5 over AMS-C-26074, Class 4, Grade B
E	● Cadmium Plate, Gold Iridite, Over Electroless Nickel	MIL-C-5541, Class 3 AMS-QQ-P-416, Type II, Class 3 over AMS-C-26074, Class 4, Grade B
C	● Cadmium Plate, Olive Drab	AMS-QQ-P-416, Type II, Class 3, 48 Hours
A	● Cadmium Plate, Olive Drab Over Electroless Nickel	1000 Hour Corrosion Resistance
N	● Electroless Nickel	AMS-C-26074, Class 4, Grade B
L	● Zinc Cobalt, Dark Olive Drab	96 Hour Corrosion Resistance
P	● Passivated, Stainless Steel	AMS-QQ-P-35
T	● Nickel, Fluorocarbon Polymer	500 Hour Corrosion Resistance
W	● Zinc Nickel, Black	ASTM B841 Type D

**TABLE II. ATTACHMENT CODES**

Attachment Code	Description
A	No Attachment Required
B	Bead Chain, Brass, Nickel Plated
C	Sash Chain, SST, Passivated
D	Bead Chain, SST, Passivated
E	Bead Chain, Brass, Cadmium, Olive Drab Plated
F	Bead Chain, Brass, Unfinished
I	Bead Chain, Brass, Black Oxide Finish
N	Wire Rope, No Jacket
P	Wire Rope, Polyurethane Jacket with Terminal
R	Wire Rope, SST, PVC Covered, Green Color
T	Wire Rope, SST, Teflon Covered, Natural Cover
U	Wire Rope, SST, Nylon Covered, Brown Color
V	Wire Rope, SST, Viton Covered, Black Color
W	Nylon Cord, Green Color, SST Terminal

**TABLE III. GASKET MATERIAL CODES**

Material Code	Material Description
A	Fluorosilicone, Blue
N	Neoprene, Black, MIL-R-3065
O	None Required
S	Silicone, Red, ZZ-R-765
C	Conductive Silicone

**TABLE IV. EYELET END FITTING STYLES AND SIZES**  
 (NOT USED WITH ATTACHMENT CODE A)

Dash No. Code	Y Ref. Dia.
00	No Eyelet
01	.125
02	.141
03	.167
04	.188
05	.219
06	.250
07	.156
08	.121

USED WITH ATTACHMENT CODES:

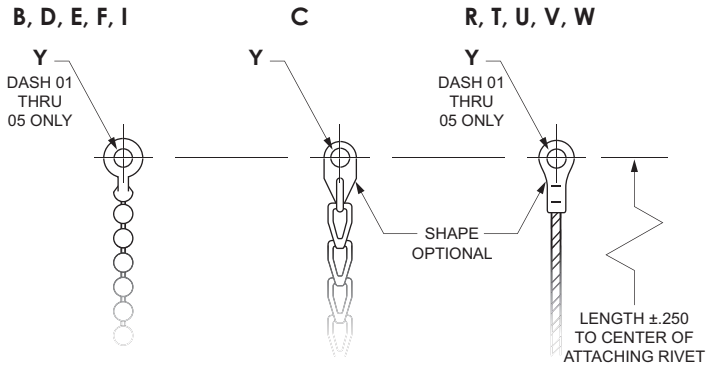

**TABLE V. RING END FITTING SIZES**  
 (NOT USED WITH ATTACHMENT CODE A)

DASH NO. CODE	Z RANGE	DASH NO. CODE	Z RANGE	DASH NO. CODE	Z RANGE
33	.401 - .391	15	1.072 - 1.052	24	2.088 - 2.078
34	.454 - .444	16	1.198 - 1.178	25	2.151 - 2.141
35	.464 - .454	17	1.322 - 1.302	26	2.276 - 2.266
36	.526 - .516	18	1.448 - 1.428	27	2.338 - 2.328
11	.604 - .584	19	1.572 - 1.552	28	2.401 - 2.391
37	.651 - .641	20	1.698 - 1.678	29	2.526 - 2.516
12	.729 - .709	21	1.822 - 1.802	30	2.651 - 2.641
13	.885 - .865	22	1.948 - 1.928	31	2.901 - 2.891
14	.948 - .918	23	2.026 - 2.016	32	3.026 - 3.016

USED WITH ATTACHMENT CODES:  
 B THRU W

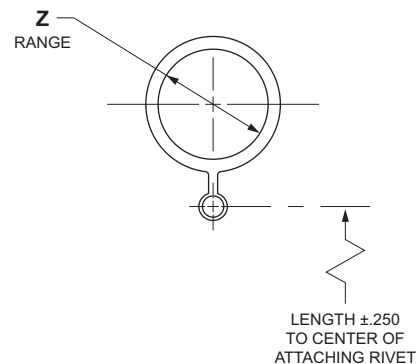

# SPACECRAFT COMPONENTS CORP.

Your Connector Consultant Since 1962

## Try Our Other Connector Products



SCP 5015 STYLE CONNECTORS (CATALOG 102)



SCPT 26482 STYLE SC1 38999 SERIES I SC2 38999 SERIES II SC39 38999 SERIES III (CATALOG 202)



SCPB SERIES (CATALOG 302)



CONNECTOR ACCESSORIES (CATALOG 402)



CONNECTORS WITH INTEGRATED BACKSHELLS (CATALOG 601)



### Get All of Our Catalogs & Product Brochures on One Disc



## SPACECRAFT COMPONENTS CORP.



### Headquarters

3040 Clayton Street  
North Las Vegas, NV 89032

Phone: 702.851.7600  
Fax: 702.851.7620

Email: [salesinfo@spacecraft.com](mailto:salesinfo@spacecraft.com)  
Web: [www.spacecraft.com](http://www.spacecraft.com)

### Florida Office

4577 Nob Hill Road  
Suite 106  
Sunrise, FL 33351  
Tel: 954.748.4540  
Fax: 954.748.4128

### Arizona Office

519 W. Lone Cactus Dr.  
Suite 401  
Phoenix, AZ 85027  
Tel: 623.580.1162  
Fax: 623.580.1165

### Italy Office

Spacecraft Components, sp A  
Milan, Italy  
+39 [335] 719.4512

### Mexico Office

Av. Constituyentes 13-6 Col. Pueblo Nuevo  
Queretaro, Qro 76900  
+52 442 341 69 63

COMING SOON...  
All Plastic Connectors  
CATALOG 701

APR 2013  
SF-142

COMPILED AND PRODUCED BY SPACECRAFT COMPONENTS CORP.  
©2012 SPACECRAFT COMPONENTS CORP., NORTH LAS VEGAS, NV 89032