

PLEASE CHECK WWW.MOLEX.COM FOR LATEST PART INFORMATION

Part Number: [043860002](#)
Status: **Active**
Overview: [Modular Jacks and Plugs](#)
Description: Modular Jack, Right Angle, Low Profile, Inverted, 6/6

Documents:

3D Model	Application Specification AS-43860-001 (PDF)
Drawing (PDF)	Test Summary TS-43860-001 (PDF)
Product Specification PS-43860-003 (PDF)	RoHS Certificate of Compliance (PDF)

Agency Certification

CSA	LR19980
UL	E107635

General

Product Family	Modular Jacks/Plugs
Series	43860
Component Type	PCB Jack
Magnetic	No
Overview	Modular Jacks and Plugs
Performance Category	3
Power over Ethernet (PoE)	N/A
Product Name	RJ11
UPC	800754319393

Physical

Boot Color	N/A
Color - Resin	Black
Durability (mating cycles max)	500
Flammability	94V-0
Inverted / Top Latch	Yes
Jack Height	13.21mm
Lightpipes/LEDs	None
Material - Metal	Phosphor Bronze
Material - Plating Mating	Gold
Material - Plating Termination	Tin
Material - Resin	High Temperature Thermoplastic
Net Weight	2.182/g
Orientation	Right Angle (Side Entry)
PCB Locator	Yes
PCB Retention	Yes
PCB Thickness - Recommended	1.60mm
Packaging Type	Tube
Pitch - Mating Interface	1.02mm
Pitch - Termination Interface	1.02mm
Plating min - Mating	1.270µm
Plating min - Termination	2.540µm
Ports	1
Positions / Loaded Contacts	6/6
Surface Mount Compatible (SMC)	No
Temperature Range - Operating	-40°C to +85°C
Termination Interface: Style	Through Hole
Waterproof / Dustproof	No
Wire/Cable Type	N/A

Electrical

Current - Maximum per Contact	1.5A
-------------------------------	------

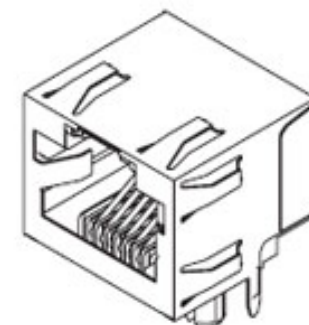

Series image - Reference only

EU ELV

Not Relevant

EU RoHS

Compliant

REACH SVHC

Contains SVHC(2015
June 15): No

Halogen-Free

Status

Not Low-Halogen

Need more information on product environmental compliance?

Email productcompliance@molex.com
Please visit the [Contact Us](#) section for any non-product compliance questions.

China ROHS

ELV

Green Image

Not Relevant

Search Parts in this Series

[43860 Series](#)

Mates With

FCC 68 Plugs

Shielded	No
Voltage - Maximum	150V AC (RMS)

Solder Process Data

Duration at Max. Process Temperature (seconds)	005
Lead-free Process Capability	WAVE
Max. Cycles at Max. Process Temperature	001
Process Temperature max. C	260

Material Info**Reference - Drawing Numbers**

Application Specification	AS-43860-001
Product Specification	PS-43860-003, RPS-43860-004, RPS-43860-007, RPS-43860-008, RPS-43860-013
Sales Drawing	SD-43860-001
Test Summary	TS-43860-001

This document was generated on 11/16/2015

PLEASE CHECK WWW.MOLEX.COM FOR LATEST PART INFORMATION