

ENERGIZER E95

D

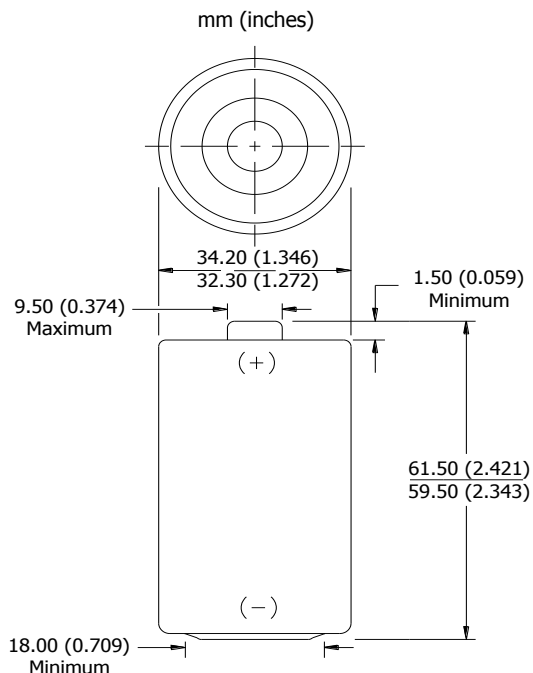

Industry Standard Dimensions



Specifications

Classification:	Alkaline
Chemical System:	Zinc-Manganese Dioxide (Zn/MnO ₂) No added mercury or cadmium
Designation:	ANSI-13A, IEC-LR20
Nominal Voltage:	1.5 volts
Nominal IR:	150 to 300 milliohms (fresh)
Operating Temp:	-18°C to 55°C (0°F to 130°F)
Typical Weight:	144.0 grams (5.1 oz.)
Typical Volume:	56.0 cubic centimeters (3.4 cubic inch)
Jacket:	Plastic Label
Shelf Life:	10 years at 21°C
Terminal:	Flat Contact

Milliamp-Hours Capacity

Continuous discharge to 0.8 volts at 21°C

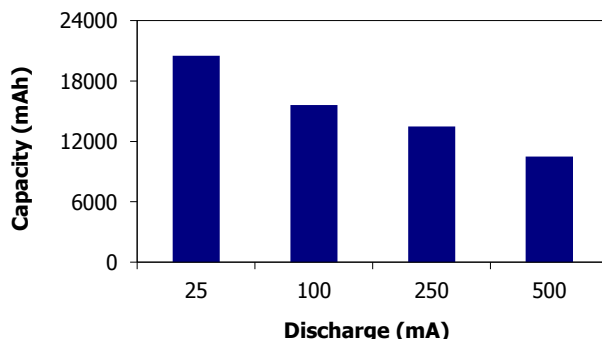

Device Selection Guide:

Portable Stereo



Toy



Lighting



Radio



Battery Selection Indicator

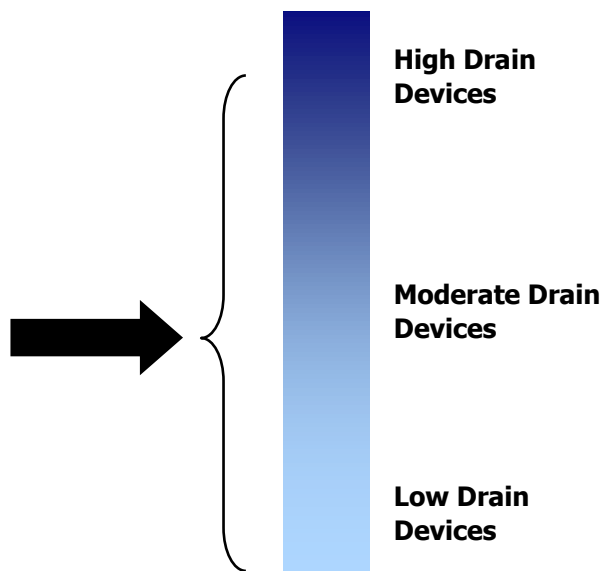

ENERGIZER E95

D

Constant Resistance Performance Typical Characteristics (21°C)

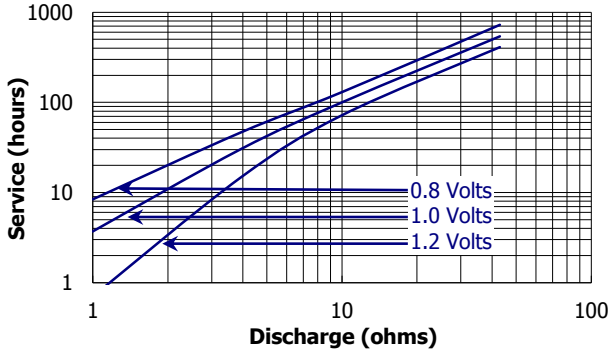

Constant Current Performance Typical Characteristics (21°C)

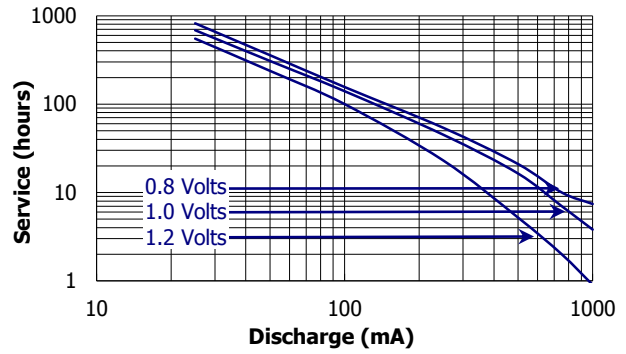

Industry Standard Tests (21°C)

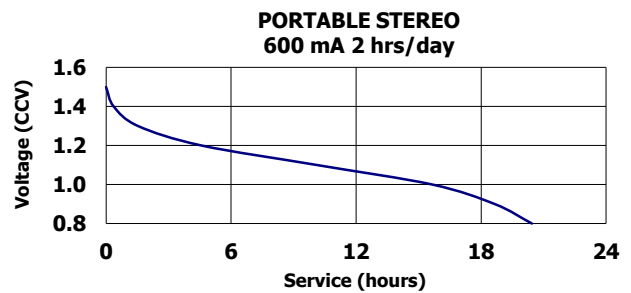
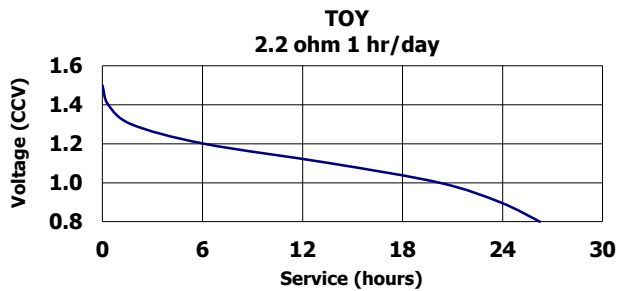
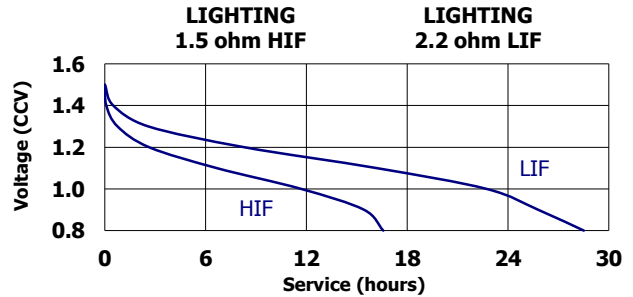
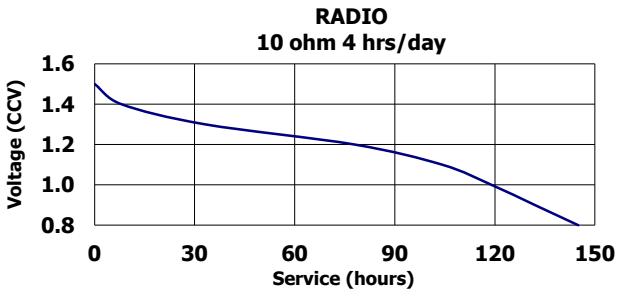

Pack Quantity : 2
 Manufacturers Part Number : E300129200
 Pack Quantity : 4
 Manufacturers Part Number : E300129100