

Full-color Power SMD 6mm (120° Viewing Angle)

OVSPRGBCR4

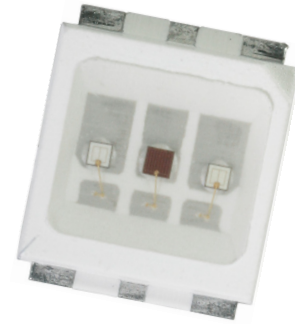

Features:

- Surface mount RGB designed for high current drive
- Low thermal resistance—20K/W
- Ultra low profile of 1.5mm
- High flux output

Description:

The **OVSPRGBCR4** is an energy-efficient packaged LED source that offers high luminance, and a long operating lifespan. This full-color power device offers a 120° viewing angle and an ultra-low profile (1.5mm) making it highly suitable for conventional lighting and specialized applications. Optional optics are offered to suit application. Please contact OPTEK for more information.

Applications:

- Automotive exterior and interior lighting
- Architectural indoor and outdoor lighting
- General lighting
- LED backlighting

Part Number	Viewing Angle	Emitted Color	Typical Intensity (mcd)	Lens Color
OVSPRGBCR4	120°	Red	9000	Water Clear
		Green	14000	Water Clear
		Blue	3550	Water Clear

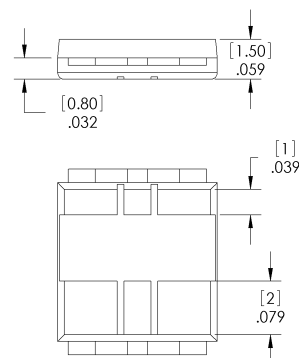
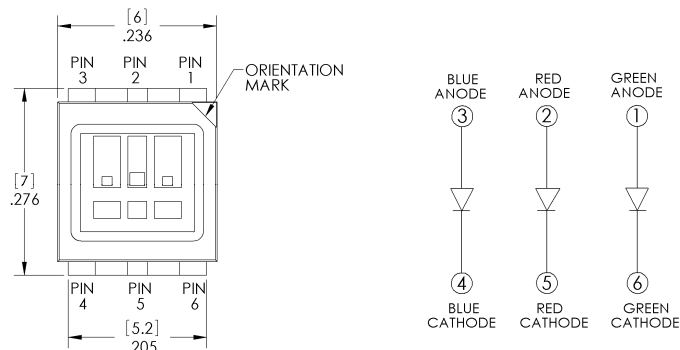

Dimensions are in inches [MM]

**DO NOT LOOK DIRECTLY AT LED
WITH UNSHIELDED EYES OR
DAMAGE TO RETINA MAY
OCCUR.**

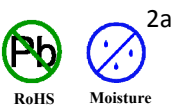

General Note

TT Electronics reserves the right to make changes in product specification without notice or liability. All information is subject to TT Electronics' own data and is considered accurate at time of going to print.



1645 Wallace Drive, Carrollton, TX 75006 | Ph: +1 972 323 2200
www.optekinc.com | www.ttelectronics.com

Electrical Specifications

Absolute Maximum Ratings ($T_A = 25^\circ\text{C}$ unless otherwise noted)

Storage Temperature Range	-40 ~ +100° C
Operating Temperature Range	-40 ~ +100° C
Reverse Voltage	5 V
DC forward current (per chip)	250 mA
Peak Pulse Current (per chip) ($T_p \leq 10$ msec, $D \leq 10\%$)	500 mA
Electrostatic Discharge (ESD Threshold [HBM])	Class 2
Moisture Sensitivity Level (IPC/JEDEC J-STD-020C)	2a / 672 Hrs
LED Junction Temperature	125° C

Optical and Electrical Characteristics ($I_F = 250$ mA, $T_A = 25^\circ\text{C}$)

SYMBOL	PARAMETER	MIN	TYP	MAX	UNITS	
V_F	Forward Voltage	Red	2.0	2.3	2.8	V
		Green	3.0	3.4	3.8	V
		Blue	3.0	3.4	3.8	V
I_V	Luminous Intensity	Red	7,150	9,000	11,250	mcd
		Green	9,000	14,000	18,000	mcd
		Blue	2240	3550	5,600	mcd
λ_D	Dominant Wavelength	Red	619	625	625	nm
		Green	520	525	535	nm
		Blue	460	465	475	nm
$2\theta_{\frac{1}{2}}$	Beam Angle	----	120	----	deg	

Beam Angle

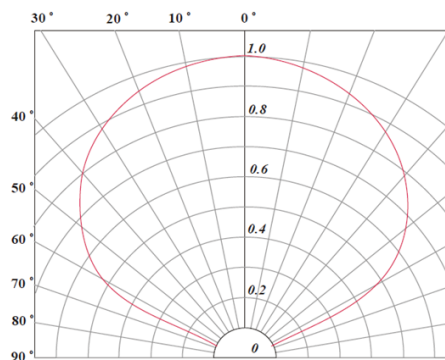

General Note

TT Electronics reserves the right to make changes in product specification without notice or liability. All information is subject to TT Electronics' own data and is considered accurate at time of going to print.



1645 Wallace Drive, Carrollton, TX 75006 | Ph: +1 972 323 2200
 www.optekinc.com | www.ttelectronics.com

Performance—Typical Electro-Optical Characteristics Curves

Forward Current Vs Forward Voltage (Red)

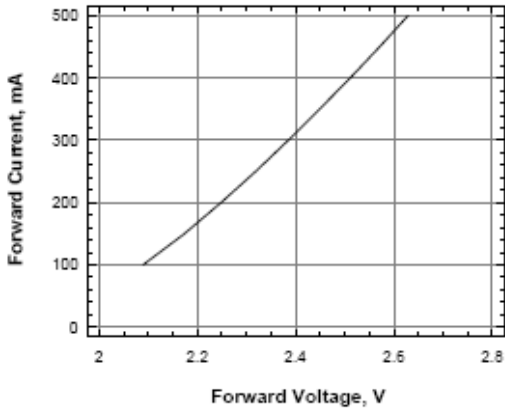

Forward Current Vs Forward Voltage (Blue and True Green)

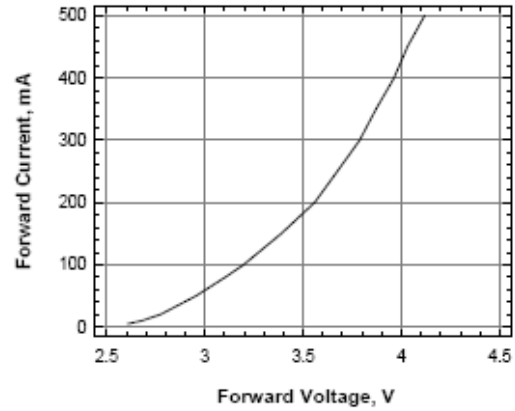

Wavelength Shift Vs Forward Current (True Green)

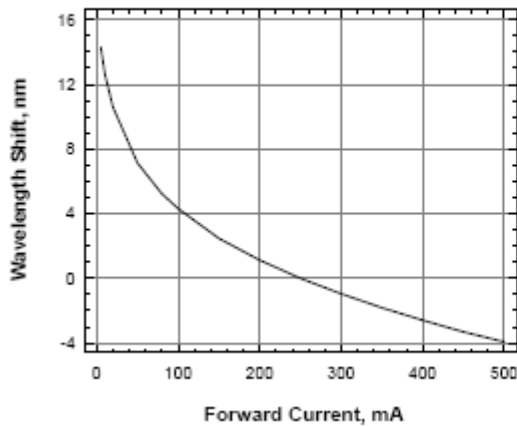

Wavelength Shift Vs Forward Current (Blue)

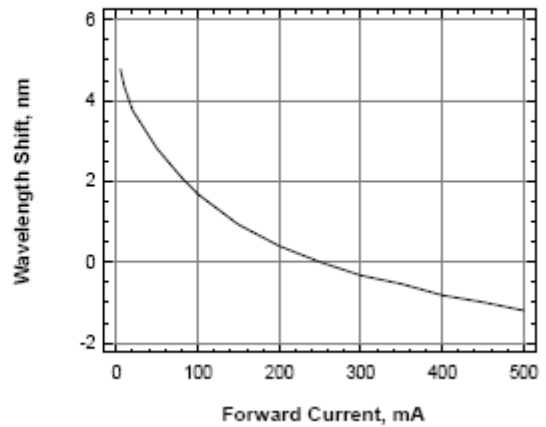

Maximum Current Vs Solder Point Temperature

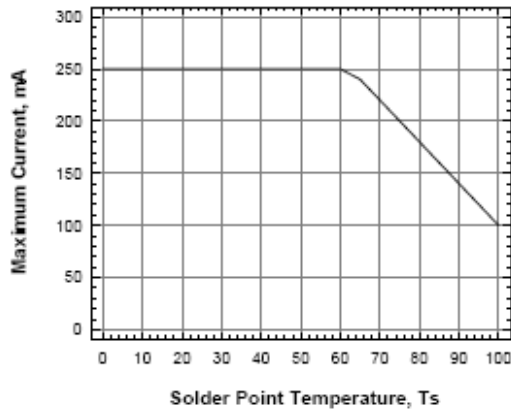

Maximum Pulse Current Vs Duty Cycle

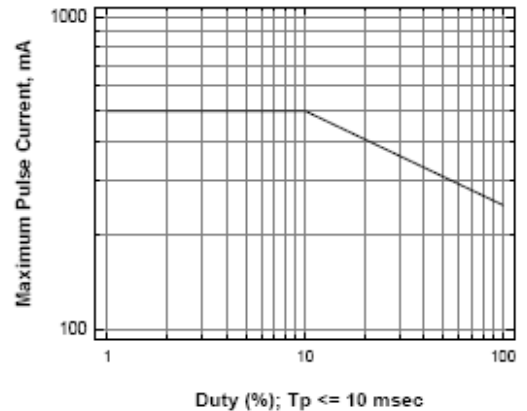

General Note

TT Electronics reserves the right to make changes in product specification without notice or liability. All information is subject to TT Electronics' own data and is considered accurate at time of going to print.

Solder Pad Design

Note: Metal core circuit board (MCPCB) is highly recommended for applications.

SOLDER PAD DESIGN

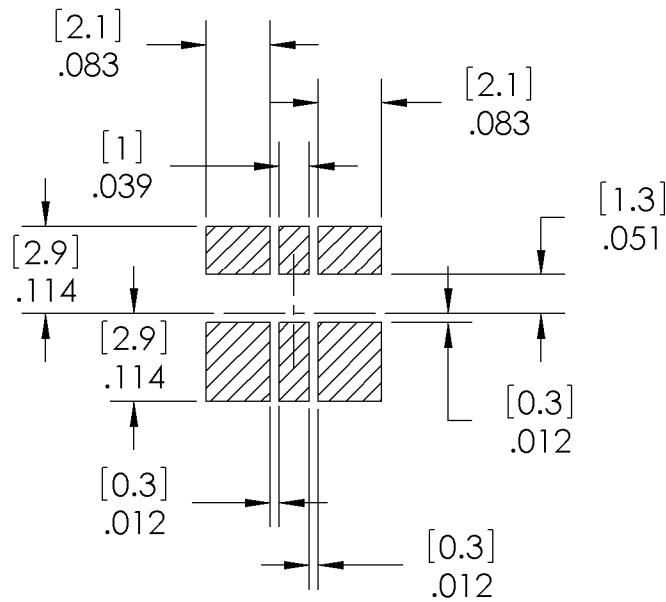

Reel Dimensions: 13-inch reel

REEL DIMENSIONS (ϕ 13 INCH [329])

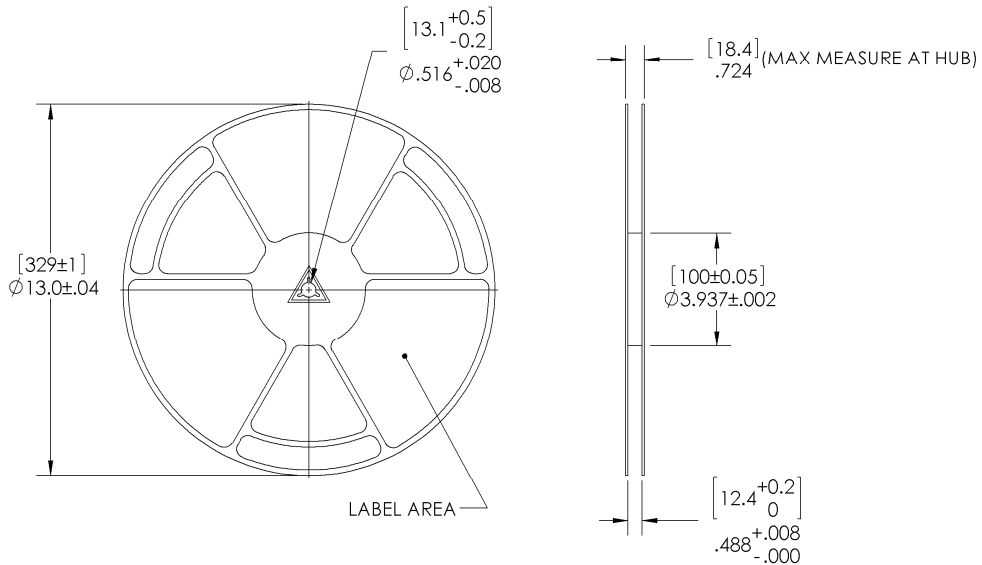

DIMENSIONS ARE IN INCHES [MM]

General Note

TT Electronics reserves the right to make changes in product specification without notice or liability. All information is subject to TT Electronics' own data and is considered accurate at time of going to print.



1645 Wallace Drive, Carrollton, TX 75006 | Ph: +1 972 323 2200
www.optekinc.com | www.ttelectronics.com

Carrier Tape Dimensions: Loaded quantity 2000 pieces per reel

Once inventory is depleted, the current 12 mm carrier tape and pocket will be replaced with new 8 mm carrier tape and pocket. See below specifications.

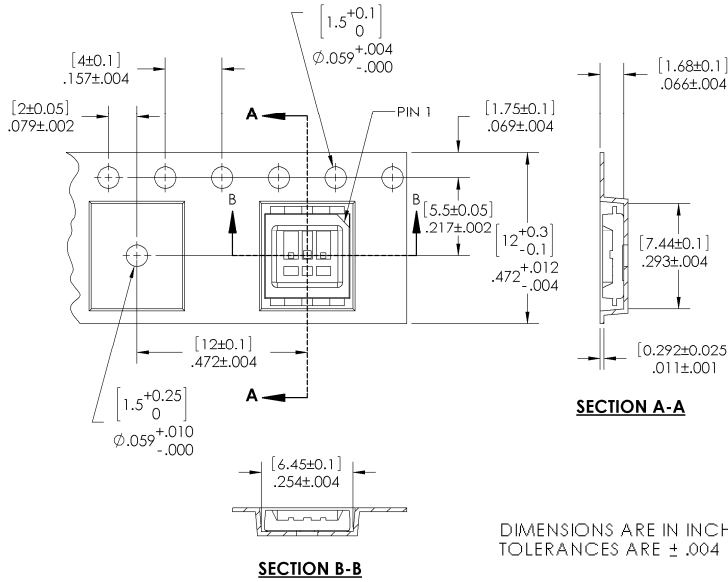

PCN 1005: New 8 mm carrier tape and pocket.

Effective: Manufacturing date codes beginning July 24, 2012

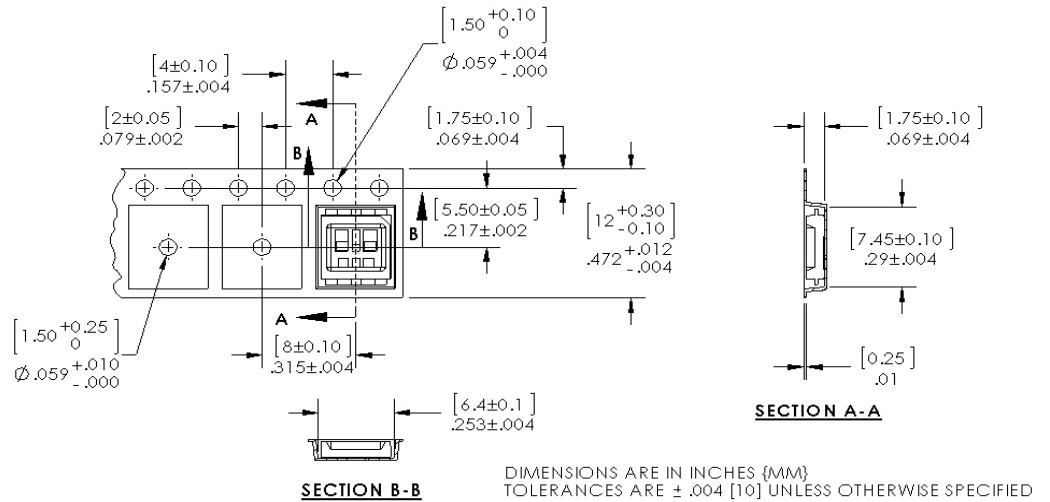

Moisture Resistant Packaging:

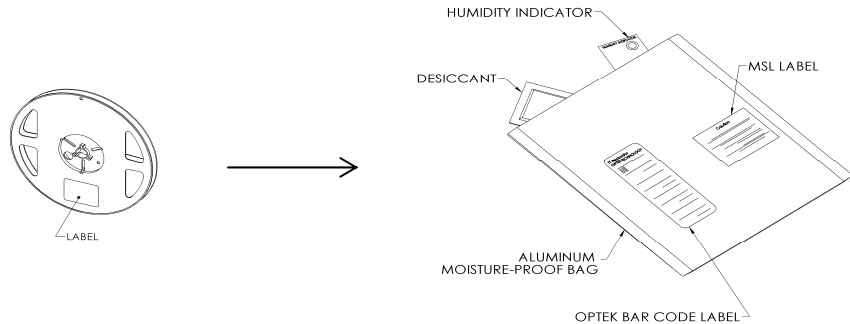

General Note

TT Electronics reserves the right to make changes in product specification without notice or liability. All information is subject to TT Electronics' own data and is considered accurate at time of going to print.

Recommended Sn-Pb IR-Reflow Soldering Profile

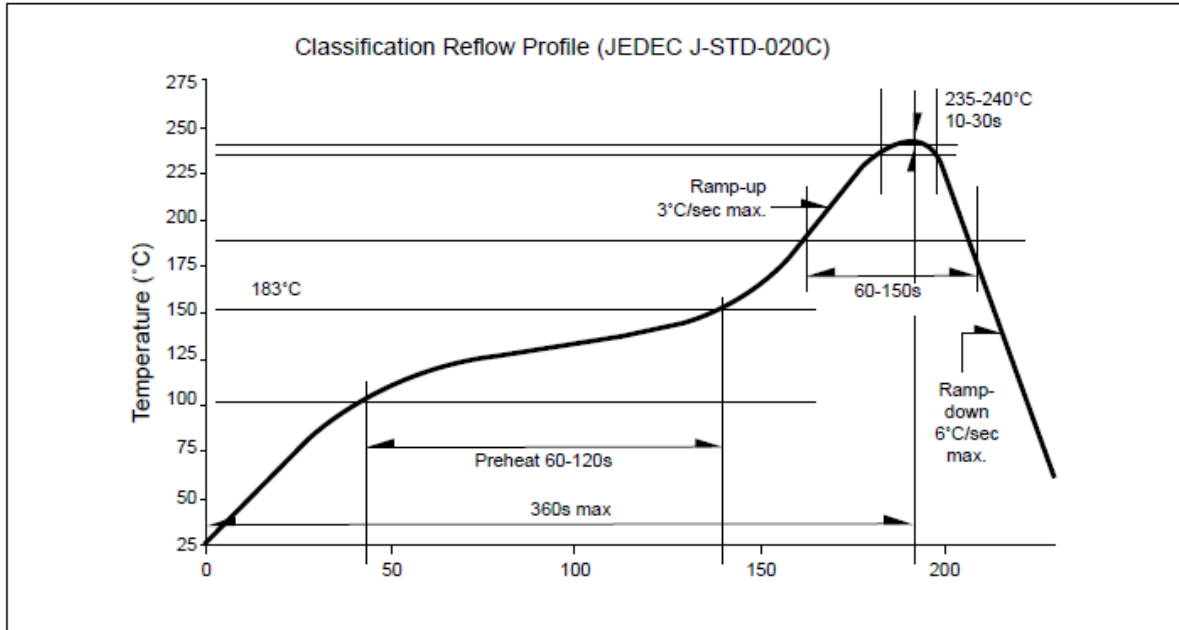

Recommended Pb-free Soldering Profile

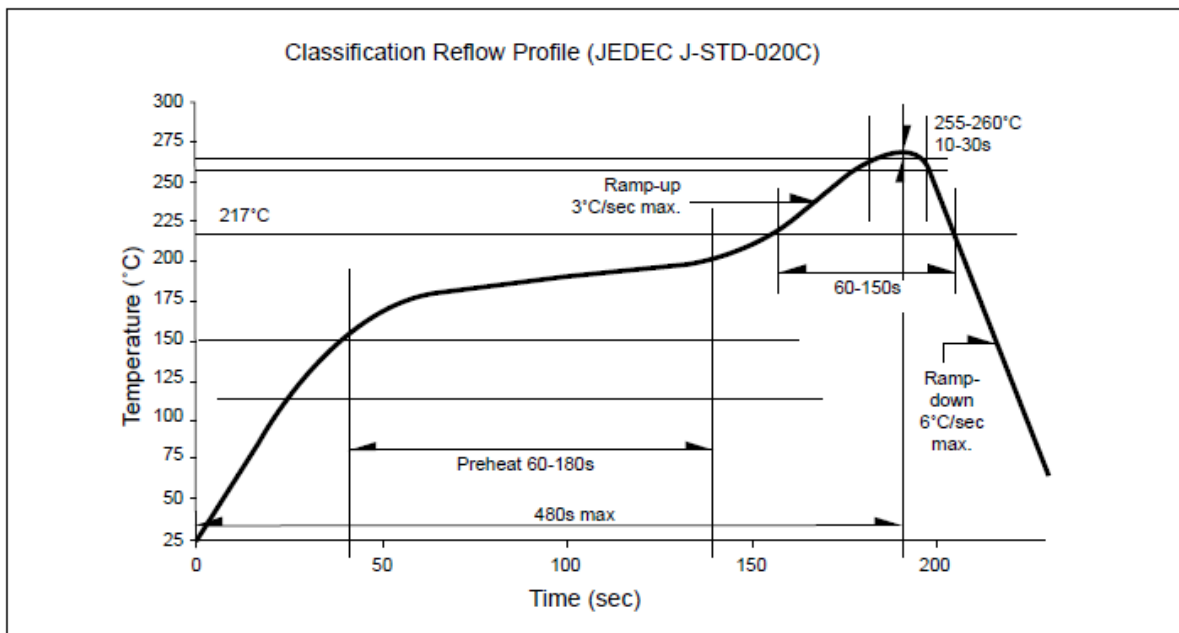

General Note

TT Electronics reserves the right to make changes in product specification without notice or liability. All information is subject to TT Electronics' own data and is considered accurate at time of going to print.



1645 Wallace Drive, Carrollton, TX 75006 | Ph: +1 972 323 2200
www.optekinc.com | www.ttelectronics.com