

FEATURES

1.8 V supply operation

Low power: 164 mW per channel at 125 MSPS

SNR = 76.5 dBFS at 70 MHz (2.0 V p-p input span)

SNR = 77.5 dBFS at 70 MHz (2.6 V p-p input span)

SFDR = 90 dBc (to Nyquist, 2.0 V p-p input span)

DNL = ± 0.7 LSB; INL = ± 3.5 LSB (2.0 V p-p input span)

Serial LVDS (ANSI-644, default) and low power, reduced range option (similar to IEEE 1596.3)

650 MHz full power analog bandwidth

2 V p-p input voltage range (supports up to 2.6 V p-p)

Serial port control

Full chip and individual channel power-down modes

Flexible bit orientation

Built-in and custom digital test pattern generation

Multichip sync and clock divider

Programmable output clock and data alignment

Standby mode

APPLICATIONS

Medical ultrasound and MRI

High speed imaging

Quadrature radio receivers

Diversity radio receivers

Test equipment

GENERAL DESCRIPTION

The **AD9653** is a quad, 16-bit, 125 MSPS analog-to-digital converter (ADC) with an on-chip sample-and-hold circuit designed for low cost, low power, small size, and ease of use. The product operates at a conversion rate of up to 125 MSPS and is optimized for outstanding dynamic performance and low power in applications where a small package size is critical.

The ADC requires a single 1.8 V power supply and LVPECL-/CMOS-/LVDS-compatible sample rate clock for full performance operation. No external reference or driver components are required for many applications.

The ADC automatically multiplies the sample rate clock for the appropriate LVDS serial data rate. A data clock output (DCO) for capturing data on the output and a frame clock output (FCO) for signaling a new output byte are provided. Individual channel power-down is supported and typically consumes less than 2 mW when all channels are disabled. The ADC contains several features designed to maximize flexibility and minimize system cost, such

FUNCTIONAL BLOCK DIAGRAM

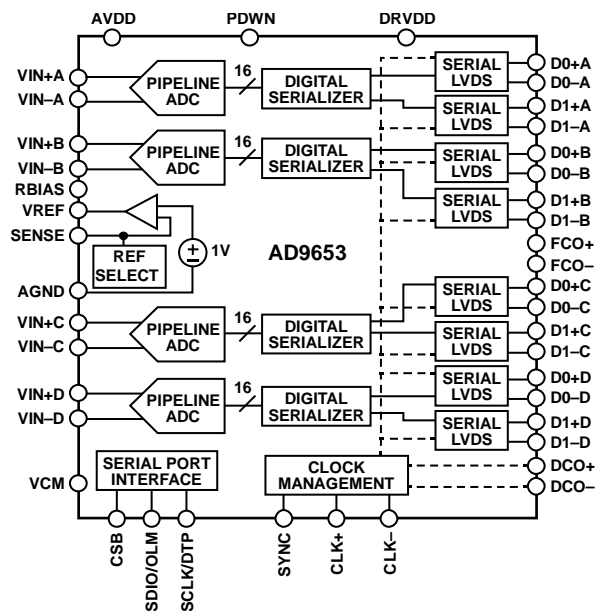

Figure 1.

as programmable output clock and data alignment and digital test pattern generation. The available digital test patterns include built-in deterministic and pseudorandom patterns, along with custom user-defined test patterns entered via the serial port interface (SPI).

The **AD9653** is available in a RoHS-compliant, 48-lead LFCSP. It is specified over the industrial temperature range of -40°C to $+85^{\circ}\text{C}$. This product is protected by a U.S. patent.

PRODUCT HIGHLIGHTS

1. Small Footprint.
Four ADCs are contained in a small, space-saving package.
2. Low power of 164 mW/channel at 125 MSPS with scalable power options.
3. Pin compatible to the **AD9253** 14-bit quad and the **AD9633** 12-bit quad ADC.
4. Ease of Use.
A data clock output (DCO) operates at frequencies of up to 500 MHz and supports double data rate (DDR) operation.
5. User Flexibility.
The SPI control offers a wide range of flexible features to meet specific system requirements.

TABLE OF CONTENTS

Features	1	Power Dissipation and Power-Down Mode	26
Applications	1	Digital Outputs and Timing	26
General Description	1	Output Test Modes	29
Functional Block Diagram	1	Serial Port Interface (SPI)	30
Product Highlights	1	Configuration Using the SPI	30
Revision History	2	Hardware Interface	31
Specifications	3	Configuration Without the SPI	31
DC Specifications	3	SPI Accessible Features	31
AC Specifications	5	Memory Map	32
Digital Specifications	7	Reading the Memory Map Register Table	32
Switching Specifications	8	Memory Map Register Table	33
Timing Specifications	9	Memory Map Register Descriptions	36
Absolute Maximum Ratings	11	Applications Information	38
Thermal Resistance	11	Design Guidelines	38
ESD Caution	11	Power and Ground Recommendations	38
Pin Configuration and Function Descriptions	12	Clock Stability Considerations	38
Typical Performance Characteristics	13	Exposed Pad Thermal Heat Slug Recommendations	38
V _{REF} = 1.0 V	13	VCM	38
V _{REF} = 1.3 V	16	Reference Decoupling	38
Equivalent Circuits	20	SPI Port	38
Theory of Operation	21	Crosstalk Performance	39
Analog Input Considerations	21	Outline Dimensions	40
Voltage Reference	22	Ordering Guide	40
Clock Input Considerations	24		
REVISION HISTORY			
11/15—Rev. C to Rev. D		11/14—Rev. 0 to Rev. A	
Changes to General Description Section	1	Changed Output Voltage (1.0 V Mode) from 1.01 V to	
Added Note 4, Table 6	8	1.02 V (max); Table 1	3
Changes to Digital Outputs and Timing Section	28	Changes to Table 3	5
		Added t _{PD} of 1.5 ns (min) and 3.1 ns (max); Table 6	8
8/15—Rev. B to Rev. C		Changed t _{SSYNC} from 0.24 ns (typ) to 1.2 ns (min) and Changed	
Change to Applications Section	1	t _{HSYNC} from 0.40 ns (typ) to -0.2 ns (min); Table 7	9
Change to Jitter Considerations Section	25	Changes to Table 10	12
		Changes to Clock Input Options Section	24
7/15—Rev. A to Rev. B		Changes to Digital Outputs and Timing Section	27
Added Patent Note, Note 1	1	Changes to Table 13	28
Change to Applications Section and General Description Section ..	1	Changes to Table 14	29
Change to Effective Number of Bits (ENOB) Parameter, Table 3 ...	5	Changes to Channel-Specific Registers Section	32
Changes to Table 5	7	Changes to Register 0x14 Bit 1 and Default Value	34
Change to Table 8	11	Changes to Register 0x16; Bits[6:4]—Input Clock Phase Adjust	
Changes to Reading the Memory Map Register Table Section		Section and Sample Rate Override (Register 0x100) Section ...	37
and Channel-Specific Registers Section	32	Added Clock Stability Considerations Section	38
Changes to Table 19	33		
Changes to Device Index (Register 0x04, Register 0x05) Section ..	36		
Changes to Clock Stability Considerations Section	38		
		5/12—Revision 0: Initial Version	

SPECIFICATIONS

DC SPECIFICATIONS

AVDD = 1.8 V, DRVDD = 1.8 V, 2.0 V p-p full-scale differential input at -1.0 dBFS; V_{REF} = 1.0 V, DCS off, unless otherwise noted.

Table 1.

Parameter ¹	Temperature	Min	Typ	Max	Unit
RESOLUTION		16			Bits
ACCURACY		Guaranteed			
No Missing Codes	Full				
Offset Error	Full	-0.49	-0.3	0.17	% FSR
Offset Matching	Full	-0.14	+0.2	0.39	% FSR
Gain Error	Full	-12.3	-5	2.37	% FSR
Gain Matching	Full	1.0	1.1	5.8	% FSR
Differential Nonlinearity (DNL)	Full	-0.77		0.95	LSB
	25°C		±0.7		LSB
Integral Nonlinearity (INL)	Full	-7.26		8.18	LSB
	25°C		±3.5		LSB
TEMPERATURE DRIFT					
Offset Error	Full	3.5			ppm/°C
INTERNAL VOLTAGE REFERENCE					
Output Voltage (1.0 V Mode)	Full	0.98	1.0	1.02	V
Load Regulation at 1.0 mA (V _{REF} = 1.0 V)	Full	2			mV
Input Resistance	25°C	7.5			kΩ
INPUT-REFERRED NOISE					
V _{REF} = 1.0 V	25°C	2.7			LSB rms
ANALOG INPUTS					
Differential Input Voltage (V _{REF} = 1.0 V)	Full	2			V p-p
Common-Mode Voltage	Full	0.9			V
Common-Mode Range	25°C	0.5	1.3		V
Differential Input Resistance	25°C	2.6			kΩ
Differential Input Capacitance	25°C	7			pF
POWER SUPPLY					
AVDD	Full	1.7	1.8	1.9	V
DRVDD	Full	1.7	1.8	1.9	V
I _{AVDD} ²	Full	305		330	mA
I _{DRVDD} (ANSI-644 Mode) ²	Full	60		64	mA
I _{DRVDD} (Reduced Range Mode) ²	25°C	45			mA
TOTAL POWER CONSUMPTION					
DC Input	Full	607		649	mW
Sine Wave Input (Four Channels Including Output Drivers, ANSI-644 Mode)	Full	657		708	mW
Sine Wave Input (Four Channels Including Output Drivers, Reduced Range Mode)	25°C	630			mW
Power-Down	25°C	2			mW
Standby ³	Full	356		392	mW

¹ See the [AN-835 Application Note](#), *Understanding High Speed ADC Testing and Evaluation*, for definitions and for details on how these tests were completed.

² Measured with a low input frequency, full-scale sine wave on all four channels.

³ Can be controlled via the SPI.

AVDD = 1.8 V, DRVDD = 1.8 V, 2.6 V p-p full-scale differential input at -1.0 dBFS; V_{REF} = 1.3 V; 0°C to 85°C, DCS off, unless otherwise noted.

Table 2.

Parameter ¹	Temperature	Min	Typ	Max	Unit
RESOLUTION		16			Bits
ACCURACY					
No Missing Codes	25°C		Guaranteed		
Offset Error	25°C		-0.3		% FSR
Offset Matching	25°C		+0.2		% FSR
Gain Error	25°C		-5		% FSR
Gain Matching	25°C		1.1		% FSR
Differential Nonlinearity (DNL)	25°C		±0.8		LSB
Integral Nonlinearity (INL)	25°C		±5.0		LSB
TEMPERATURE DRIFT					
Offset Error	25°C		3.5		ppm/°C
INTERNAL VOLTAGE REFERENCE					
Output Voltage (1.3 V Programmable Mode)	25°C		1.3		V
Load Regulation at 1.0 mA (V _{REF} = 1.3 V)	25°C		6.5		mV
Input Resistance	25°C		7.5		kΩ
INPUT-REFERRED NOISE					
V _{REF} = 1.3 V	25°C		2.1		LSB rms
ANALOG INPUTS					
Differential Input Voltage (V _{REF} = 1.3 V)	25°C		2.6		V p-p
Common-Mode Voltage	25°C		0.9		V
Common-Mode Range	25°C	0.6		1.3	V
Differential Input Resistance	25°C		2.6		kΩ
Differential Input Capacitance	25°C		7		pF
POWER SUPPLY					
AVDD	25°C		1.8		V
DRVDD	25°C		1.8		V
I _{AVDD} ²	25°C		314		mA
I _{DRVDD} (ANSI-644 Mode) ²	25°C		60		mA
I _{DRVDD} (Reduced Range Mode) ²	25°C		45		mA
TOTAL POWER CONSUMPTION					
DC Input	25°C		614		mW
Sine Wave Input (Four Channels Including Output Drivers, ANSI-644 Mode)	25°C		673		mW
Sine Wave Input (Four Channels Including Output Drivers, Reduced Range Mode)	25°C		646		mW
Power-Down	25°C		2		mW
Standby ³	25°C		371		mW

¹ See the [AN-835 Application Note, Understanding High Speed ADC Testing and Evaluation](#), for definitions and for details on how these tests were completed.

² Measured with a low input frequency, full-scale sine wave on all four channels.

³ Can be controlled via the SPI.

AC SPECIFICATIONS

AVDD = 1.8 V, DRVDD = 1.8 V, 2.0 V p-p full-scale differential input at -1.0 dBFS; V_{REF} = 1.0 V, DCS off, unless otherwise noted.

Table 3.

Parameter ¹	Temperature	Min	Typ	Max	Unit
SIGNAL-TO-NOISE RATIO (SNR)					
f _{IN} = 9.7 MHz	25°C		78		dBFS
f _{IN} = 15 MHz	25°C		77.8		dBFS
f _{IN} = 70 MHz	Full	75.5	76.5		dBFS
f _{IN} = 128 MHz	25°C		73.9		dBFS
f _{IN} = 200 MHz	25°C		71.5		dBFS
SIGNAL-TO-NOISE-AND-DISTORTION RATIO (SINAD)					
f _{IN} = 9.7 MHz	25°C		78		dBFS
f _{IN} = 15 MHz	25°C		77.7		dBFS
f _{IN} = 70 MHz	Full	74.6	76.1		dBFS
f _{IN} = 128 MHz	25°C		73.6		dBFS
f _{IN} = 200 MHz	25°C		70.3		dBFS
EFFECTIVE NUMBER OF BITS (ENOB)					
f _{IN} = 9.7 MHz	25°C		12.7		Bits
f _{IN} = 15 MHz	25°C		12.6		Bits
f _{IN} = 70 MHz	Full	12.1	12.3		Bits
f _{IN} = 128 MHz	25°C		11.9		Bits
f _{IN} = 200 MHz	25°C		11.4		Bits
SPURIOUS-FREE DYNAMIC RANGE (SFDR)					
f _{IN} = 9.7 MHz	25°C		96		dBc
f _{IN} = 15 MHz	25°C		93		dBc
f _{IN} = 70 MHz	Full	78	89		dBc
f _{IN} = 128 MHz	25°C		87		dBc
f _{IN} = 200 MHz	25°C		77		dBc
WORST HARMONIC (SECOND OR THIRD)					
f _{IN} = 9.7 MHz	25°C		-98		dBc
f _{IN} = 15 MHz	25°C		-93		dBc
f _{IN} = 70 MHz	Full		-89	-78	dBc
f _{IN} = 128 MHz	25°C		-87		dBc
f _{IN} = 200 MHz	25°C		-77		dBc
WORST OTHER HARMONIC OR SPUR					
f _{IN} = 9.7 MHz	25°C		-96		dBc
f _{IN} = 15 MHz	25°C		-98		dBc
f _{IN} = 70 MHz	Full		-94	-85	dBc
f _{IN} = 128 MHz	25°C		-89		dBc
f _{IN} = 200 MHz	25°C		-83		dBc
TWO-TONE INTERMODULATION DISTORTION (IMD)—AIN1 AND AIN2 = -7.0 dBFS					
f _{IN1} = 70.5 MHz, f _{IN2} = 72.5 MHz	25°C		-90		dBc
CROSSTALK ²	25°C		-91		dB
CROSSTALK (OVERRANGE CONDITION) ³	25°C		-87		dB
POWER SUPPLY REJECTION RATIO (PSRR) ⁴					
AVDD	25°C		31		dB
DRVDD	25°C		79		dB
ANALOG INPUT BANDWIDTH, FULL POWER	25°C		650		MHz

¹ See the [AN-835 Application Note](#), *Understanding High Speed ADC Testing and Evaluation*, for definitions and for details on how these tests were completed.

² Crosstalk is measured at 70 MHz with -1.0 dBFS analog input on one channel and no input on the adjacent channel.

³ Overrange condition is defined as the input being 3 dB above full scale.

⁴ PSRR is measured by injecting a sinusoidal signal at 10 MHz to the power supply pin and measuring the output spur on the FFT. PSRR is calculated as the ratio of the amplitudes of the spur voltage over the pin voltage, expressed in decibels.

AVDD = 1.8 V, DRVDD = 1.8 V, 2.6 V p-p full-scale differential input at -1.0 dBFS; $V_{REF} = 1.3$ V; 0°C to 85°C , DCS off, unless otherwise noted.

Table 4.

Parameter ¹	Temperature	Min	Typ	Max	Unit
SIGNAL-TO-NOISE RATIO (SNR)					
$f_{IN} = 9.7$ MHz	25°C		80		dBFS
$f_{IN} = 15$ MHz	25°C		79.4		dBFS
$f_{IN} = 70$ MHz	25°C		77.5		dBFS
$f_{IN} = 128$ MHz	25°C		74.4		dBFS
$f_{IN} = 200$ MHz	25°C		71.7		dBFS
SIGNAL-TO-NOISE-AND-DISTORTION RATIO (SINAD)					
$f_{IN} = 9.7$ MHz	25°C		79.8		dBFS
$f_{IN} = 15$ MHz	25°C		79.2		dBFS
$f_{IN} = 70$ MHz	25°C		76.1		dBFS
$f_{IN} = 128$ MHz	25°C		74		dBFS
$f_{IN} = 200$ MHz	25°C		69.9		dBFS
EFFECTIVE NUMBER OF BITS (ENOB)					
$f_{IN} = 9.7$ MHz	25°C		13		Bits
$f_{IN} = 15$ MHz	25°C		12.9		Bits
$f_{IN} = 70$ MHz	25°C		12.3		Bits
$f_{IN} = 128$ MHz	25°C		12		Bits
$f_{IN} = 200$ MHz	25°C		11.3		Bits
SPURIOUS-FREE DYNAMIC RANGE (SFDR)					
$f_{IN} = 9.7$ MHz	25°C		94		dBc
$f_{IN} = 15$ MHz	25°C		94		dBc
$f_{IN} = 70$ MHz	25°C		82		dBc
$f_{IN} = 128$ MHz	25°C		86		dBc
$f_{IN} = 200$ MHz	25°C		75		dBc
WORST HARMONIC (SECOND OR THIRD)					
$f_{IN} = 9.7$ MHz	25°C		-94		dBc
$f_{IN} = 15$ MHz	25°C		-94		dBc
$f_{IN} = 70$ MHz	25°C		-82		dBc
$f_{IN} = 128$ MHz	25°C		-87		dBc
$f_{IN} = 200$ MHz	25°C		-75		dBc
WORST OTHER HARMONIC OR SPUR					
$f_{IN} = 9.7$ MHz	25°C		-100		dBc
$f_{IN} = 15$ MHz	25°C		-99		dBc
$f_{IN} = 70$ MHz	25°C		-96		dBc
$f_{IN} = 128$ MHz	25°C		-86		dBc
$f_{IN} = 200$ MHz	25°C		-84		dBc
TWO-TONE INTERMODULATION DISTORTION (IMD)— A_{IN1} AND $A_{IN2} = -7.0$ dBFS					
$f_{IN1} = 70.5$ MHz, $f_{IN2} = 72.5$ MHz	25°C		-90		dBc
CROSSTALK ²					
	25°C		91		dB
CROSSTALK (OVERRANGE CONDITION) ³					
	25°C		87		dB
POWER SUPPLY REJECTION RATIO (PSRR) ⁴					
AVDD	25°C		31		dB
DRVDD	25°C		79		dB
ANALOG INPUT BANDWIDTH, FULL POWER					
	25°C		650		MHz

¹ See the [AN-835 Application Note, Understanding High Speed ADC Testing and Evaluation](#), for definitions and for details on how these tests were completed.

² Crosstalk is measured at 70 MHz with -1.0 dBFS analog input on one channel and no input on the adjacent channel.

³ Overrange condition is defined as the input being 3 dB above full scale.

⁴ PSRR is measured by injecting a sinusoidal signal at 10 MHz to the power supply pin and measuring the output spur on the FFT. PSRR is calculated as the ratio of the amplitudes of the spur voltage over the pin voltage, expressed in decibels.

DIGITAL SPECIFICATIONS

AVDD = 1.8 V, DRVDD = 1.8 V, unless otherwise noted.

Table 5.

Parameter ¹	Temp	Min	Typ	Max	Unit
CLOCK INPUTS (CLK+, CLK-)					
Logic Compliance			CMOS/LVDS/LVPECL		
Differential Input Voltage ²	Full	0.2		3.6	V p-p
Input Voltage Range	Full	AGND - 0.2		AVDD + 0.2	V
Input Common-Mode Voltage	Full		0.9		V
Input Resistance (Differential)	25°C		15		kΩ
Input Capacitance	25°C		4		pF
LOGIC INPUTS (PDWN, SYNC, SCLK)					
Logic 1 Voltage	Full	1.2		AVDD + 0.2	V
Logic 0 Voltage	Full	0		0.8	V
Input Resistance	25°C		30		kΩ
Input Capacitance	25°C		2		pF
LOGIC INPUT (CSB)					
Logic 1 Voltage	Full	1.2		AVDD + 0.2	V
Logic 0 Voltage	Full	0		0.8	V
Input Resistance	25°C		26		kΩ
Input Capacitance	25°C		2		pF
LOGIC INPUT (SDIO)					
Logic 1 Voltage	Full	1.2		AVDD + 0.2	V
Logic 0 Voltage	Full	0		0.8	V
Input Resistance	25°C		26		kΩ
Input Capacitance	25°C		5		pF
LOGIC OUTPUT (SDIO) ³					
Logic 1 Voltage (I _{OH} = 800 μA)	Full		1.79		V
Logic 0 Voltage (I _{OL} = 50 μA)	Full			0.05	V
DIGITAL OUTPUTS (D0±x, D1±x), ANSI-644					
Logic Compliance			LVDS		
Differential Output Voltage (V _{OD})	Full	±290	±345	±400	mV
Output Offset Voltage (V _{OS})	Full	1.15	1.25	1.35	V
Output Coding (Default)			Twos complement		
DIGITAL OUTPUTS (D0±x, D1±x), LOW POWER, REDUCED SIGNAL OPTION					
Logic Compliance			LVDS		
Differential Output Voltage (V _{OD})	Full	±160	±200	±230	mV
Output Offset Voltage (V _{OS})	Full	1.15	1.25	1.35	V
Output Coding (Default)			Twos complement		

¹ See the [AN-835 Application Note, Understanding High Speed ADC Testing and Evaluation](#), for definitions and for details on how these tests were completed.² This is specified for LVDS and LVPECL only.³ This is specified for 13 SDIO/OLM pins sharing the same connection.

SWITCHING SPECIFICATIONS

AVDD = 1.8 V, DRVDD = 1.8 V, unless otherwise noted.

Table 6.

Parameter ^{1,2}	Temp	Min	Typ	Max	Unit
CLOCK³					
Input Clock Rate	Full	20		1000	MHz
Conversion Rate ⁴	Full	20		125	MSPS
Clock Pulse Width High (t_{EH})	Full		4.00		ns
Clock Pulse Width Low (t_{EL})	Full		4.00		ns
OUTPUT PARAMETERS³					
Propagation Delay (t_{PD})	Full	1.5	2.3	3.1	ns
Rise Time (t_R) (20% to 80%)	Full		300		ps
Fall Time (t_F) (20% to 80%)	Full		300		ps
FCO Propagation Delay (t_{FCO})	Full	1.5	2.3	3.1	ns
DCO Propagation Delay (t_{CPD}) ⁵	Full		$t_{FCO} + (t_{SAMPLE}/16)$		ns
DCO to Data Delay (t_{DATA}) ⁵	Full	$(t_{SAMPLE}/16) - 300$	$(t_{SAMPLE}/16)$	$(t_{SAMPLE}/16) + 300$	ps
DCO to FCO Delay (t_{FRAME}) ⁵	Full	$(t_{SAMPLE}/16) - 300$	$(t_{SAMPLE}/16)$	$(t_{SAMPLE}/16) + 300$	ps
Lane Delay (t_{LD})			90		ps
Data to Data Skew ($t_{DATA-MAX} - t_{DATA-MIN}$)	Full		± 50	± 200	ps
Wake-Up Time (Standby)	25°C		250		ns
Wake-Up Time (Power-Down) ⁶	25°C		375		μ s
Pipeline Latency	Full		16		Clock cycles
APERTURE					
Aperture Delay (t_A)	25°C		1		ns
Aperture Uncertainty (Jitter, t_j)	25°C		135		fs rms
Out-of-Range Recovery Time	25°C		1		Clock cycles

¹ See the [AN-835 Application Note, Understanding High Speed ADC Testing and Evaluation](#), for definitions and for details on how these tests were completed.

² Measured on standard FR-4 material.

³ Can be adjusted via the SPI. The conversion rate is the clock rate after the divider.

⁴ The maximum conversion rate is based on two-lane output mode. See the Digital Outputs and Timing section for the maximum conversion rate in one-lane output mode.

⁵ $t_{SAMPLE}/16$ is based on the number of bits in two LVDS data lanes. $t_{SAMPLE} = 1/f_s$.

⁶ Wake-up time is defined as the time required to return to normal operation from power-down mode.

TIMING SPECIFICATIONS

Table 7.

Parameter	Description	Limit	Unit
SYNC TIMING REQUIREMENTS			
t_{SSYNC}	SYNC to rising edge of CLK+ setup time	1.2	ns min
t_{HSYNC}	SYNC to rising edge of CLK+ hold time	-0.2	ns min
SPI TIMING REQUIREMENTS			
See Figure 75			
t_{DS}	Setup time between the data and the rising edge of SCLK	2	ns min
t_{DH}	Hold time between the data and the rising edge of SCLK	2	ns min
t_{CLK}	Period of the SCLK	40	ns min
t_S	Setup time between CSB and SCLK	2	ns min
t_H	Hold time between CSB and SCLK	2	ns min
t_{HIGH}	SCLK pulse width high	10	ns min
t_{LOW}	SCLK pulse width low	10	ns min
t_{EN_SDIO}	Time required for the SDIO pin to switch from an input to an output relative to the SCLK falling edge (not shown in Figure 75)	10	ns min
t_{DIS_SDIO}	Time required for the SDIO pin to switch from an output to an input relative to the SCLK rising edge (not shown in Figure 75)	10	ns min

Timing Diagrams

Refer to the Memory Map Register Descriptions section and Table 23 for SPI register settings.

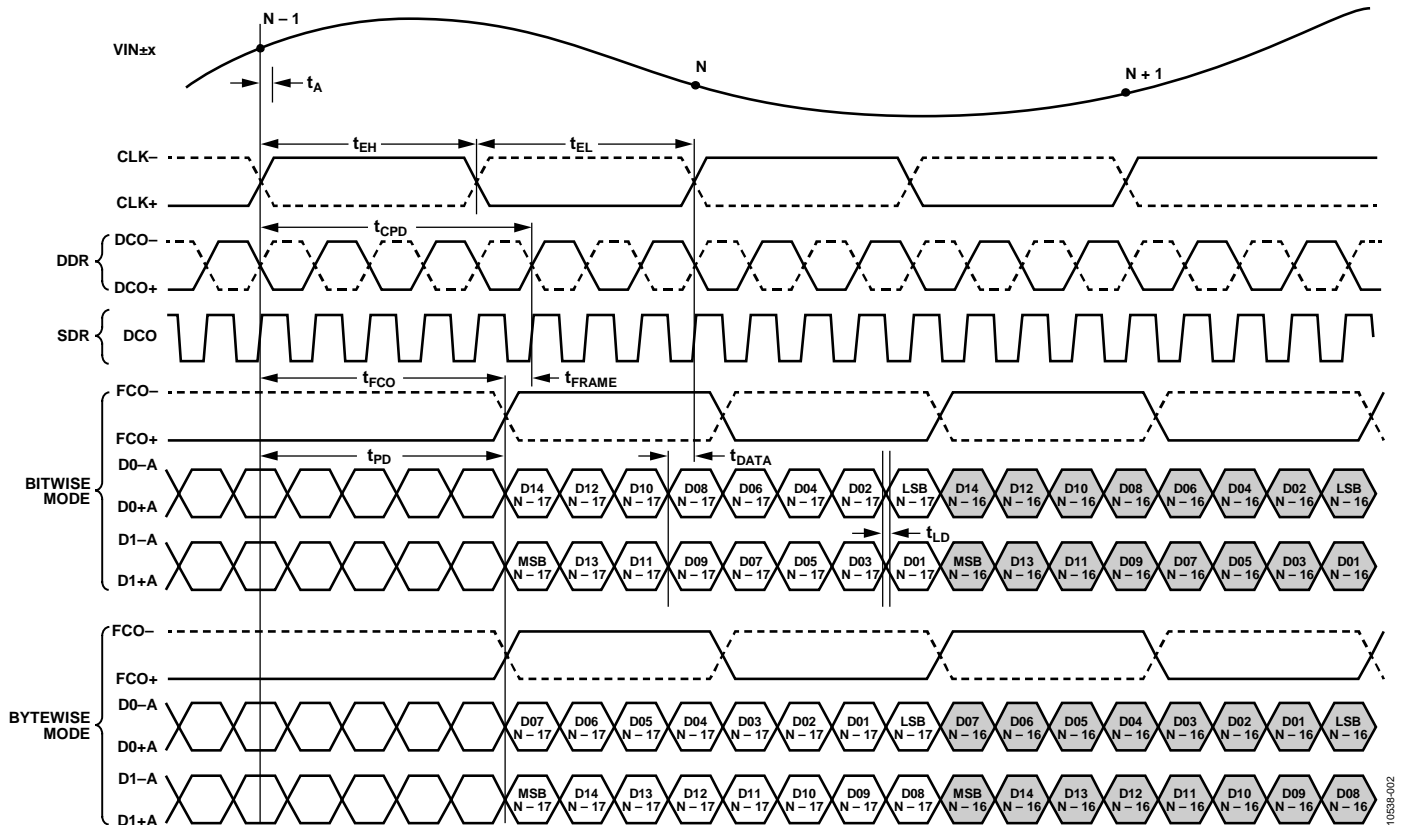

Figure 2. 16-Bit DDR/SDR, Two-Lane, 1x Frame Mode (Default)

10598-002

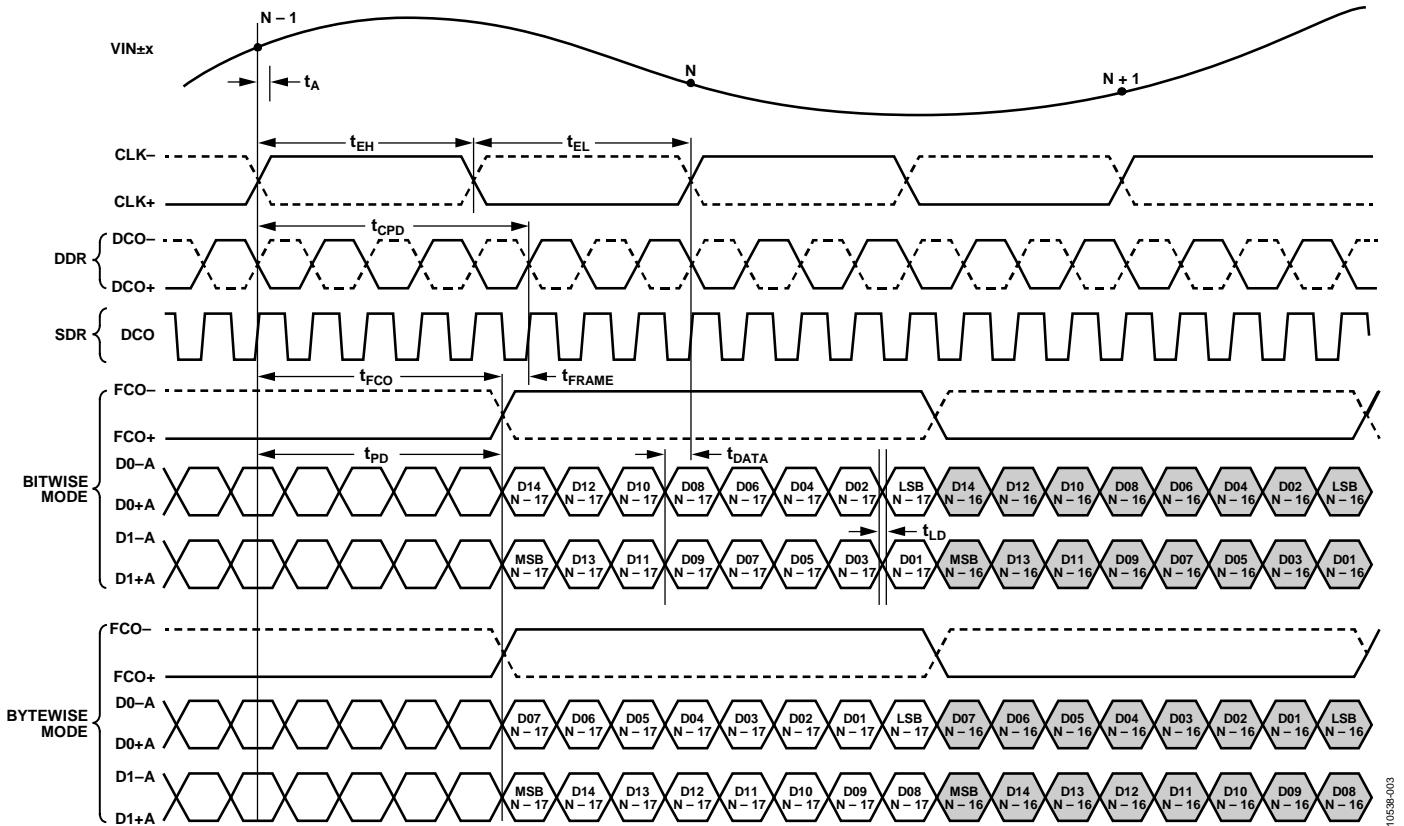

Figure 3. 16-Bit DDR/SDR, Two-Lane, 2x Frame Mode

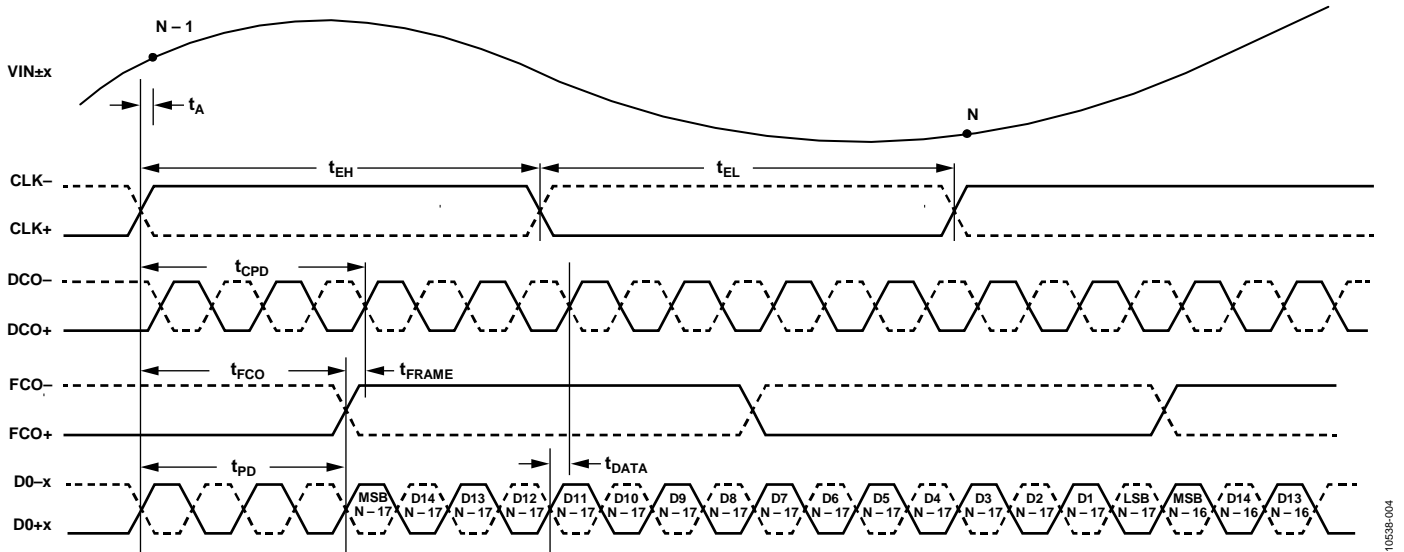

Figure 4. Wordwise DDR, One-Lane, 1x Frame, 16-Bit Output Mode

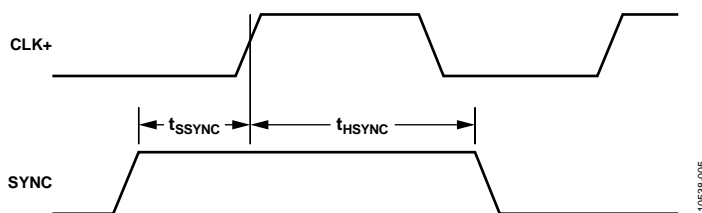

Figure 5. SYNC Input Timing Requirements

ABSOLUTE MAXIMUM RATINGS

Table 8.

Parameter	Rating
Electrical	
AVDD to AGND	-0.3 V to +2.0 V
DRVDD to AGND	-0.3 V to +2.0 V
Digital Outputs (D0±x, D1±x, DCO+, DCO-, FCO+, FCO-) to AGND	-0.3 V to +2.0 V
CLK+, CLK- to AGND	-0.3 V to +2.0 V
VIN+x, VIN-x to AGND	-0.3 V to +2.0 V
SCLK/DTP, SDIO/OLM, CSB to AGND	-0.3 V to +2.0 V
SYNC, PDWN to AGND	-0.3 V to +2.0 V
RBIAS, VCM to AGND	-0.3 V to +2.0 V
VREF, SENSE to AGND	-0.3 V to +2.0 V
Environmental	
Operating Temperature Range (Ambient, $V_{REF} = 1.0$ V)	-40°C to +85°C
Operating Temperature Range (Ambient, $V_{REF} = 1.3$ V)	0°C to 85°C
Maximum Junction Temperature	150°C
Lead Temperature (Soldering, 10 sec)	300°C
Storage Temperature Range (Ambient)	-65°C to +150°C

Stresses at or above those listed under Absolute Maximum Ratings may cause permanent damage to the product. This is a stress rating only; functional operation of the product at these or any other conditions above those indicated in the operational section of this specification is not implied. Operation beyond the maximum operating conditions for extended periods may affect product reliability.

THERMAL RESISTANCE

Table 9. Thermal Resistance

Package Type	Air Flow Velocity (m/sec)	θ_{JA}^1	θ_{JB}	θ_{JC}	Unit
48-Lead LFCSP	0.0	23.7	7.8	7.1	°C/W
7 mm × 7 mm (CP-48-13)	1.0	20.0	N/A	N/A	°C/W
	2.5	18.7	N/A	N/A	°C/W

¹ θ_{JA} for a 4-layer PCB with solid ground plane (simulated). Exposed pad soldered to PCB.

ESD CAUTION



ESD (electrostatic discharge) sensitive device. Charged devices and circuit boards can discharge without detection. Although this product features patented or proprietary protection circuitry, damage may occur on devices subjected to high energy ESD. Therefore, proper ESD precautions should be taken to avoid performance degradation or loss of functionality.

PIN CONFIGURATION AND FUNCTION DESCRIPTIONS

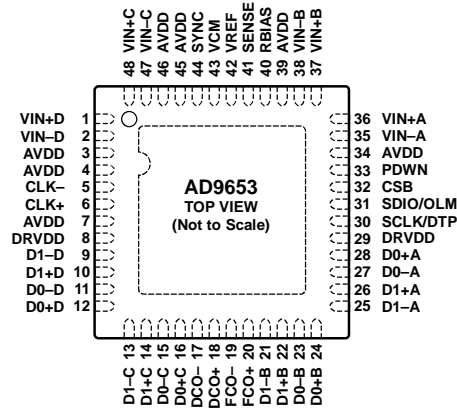

NOTES
 1. THE EXPOSED THERMAL PAD ON THE BOTTOM OF THE PACKAGE PROVIDES THE ANALOG GROUND FOR THE PART. THIS EXPOSED PAD MUST BE CONNECTED TO GROUND FOR PROPER OPERATION.

10/58-006

Figure 6. 48-Lead LFCSP Pin Configuration, Top View

Table 10. Pin Function Descriptions

Pin No.	Mnemonic	Description
0	AGND, Exposed Pad	Analog Ground, Exposed Pad. The exposed thermal pad on the bottom of the package provides the analog ground for the part. This exposed pad must be connected to ground for proper operation.
1	VIN+D	ADC D Analog Input True.
2	VIN-D	ADC D Analog Input Complement.
3, 4, 7, 34, 39, 45, 46	AVDD	1.8 V Analog Supply Pins.
5, 6	CLK-, CLK+	Differential Encode Clock. PECL, LVDS, or 1.8 V CMOS inputs.
8, 29	DRVDD	Digital Output Driver Supply.
9, 10	D1-D, D1+D	Channel D Digital Outputs, (Disabled in One-Lane Mode ¹).
11, 12	D0-D, D0+D	Channel D Digital Outputs, (disabled in One-Lane Mode ¹).
13, 14	D1-C, D1+C	Channel C Digital Outputs, (Channel D Digital Outputs in One-Lane Mode ¹).
15, 16	D0-C, D0+C	Channel C Digital Outputs.
17, 18	DCO-, DCO+	Data Clock Outputs.
19, 20	FCO-, FCO+	Frame Clock Outputs.
21, 22	D1-B, D1+B	Channel B Digital Outputs.
23, 24	D0-B, D0+B	Channel B Digital Outputs, (Channel A Digital Outputs in One-Lane Mode ¹).
25, 26	D1-A, D1+A	Channel A Digital Outputs, (Disabled in One-Lane Mode ¹).
27, 28	D0-A, D0+A	Channel A Digital Outputs, (Disabled in One-Lane Mode ¹).
30	SCLK/DTP	SPI Clock Input/Digital Test Pattern.
31	SDIO/OLM	SPI Data Input and Output Bidirectional SPI Data/Output Lane Mode.
32	CSB	SPI Chip Select Bar. Active low enable; 30 kΩ internal pull-up.
33	PDWN	Digital Input, 30 kΩ Internal Pull-Down. PDWN high = power-down device. PDWN low = run device, normal operation.
35	VIN-A	ADC A Analog Input Complement.
36	VIN+A	ADC A Analog Input True.
37	VIN+B	ADC B Analog Input True.
38	VIN-B	ADC B Analog Input Complement.
40	RBIAS	Sets Analog Current Bias. Connect to 10 kΩ (1% tolerance) resistor to ground.
41	SENSE	Reference Mode Selection.
42	VREF	Voltage Reference Input and Output.
43	VCM	Analog Input Common-Mode Voltage.
44	SYNC	Digital Input. SYNC input to clock divider.
47	VIN-C	ADC C Analog Input Complement.
48	VIN+C	ADC C Analog Input True.

¹ Output channel assignments are shown first for THE default two-lane mode. If one-lane mode is used, output channel assignments change as indicated in parenthesis. Register 0x21 Bits[6:4] invoke one-lane mode.

TYPICAL PERFORMANCE CHARACTERISTICS

$V_{REF} = 1.0 V$

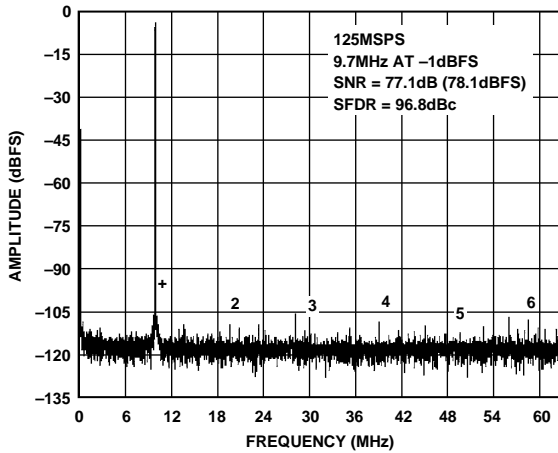

Figure 7. Single-Tone 16k FFT with $f_{IN} = 9.7 MHz$, $f_{SAMPLE} = 125 MSPS$, $V_{REF} = 1.0 V$

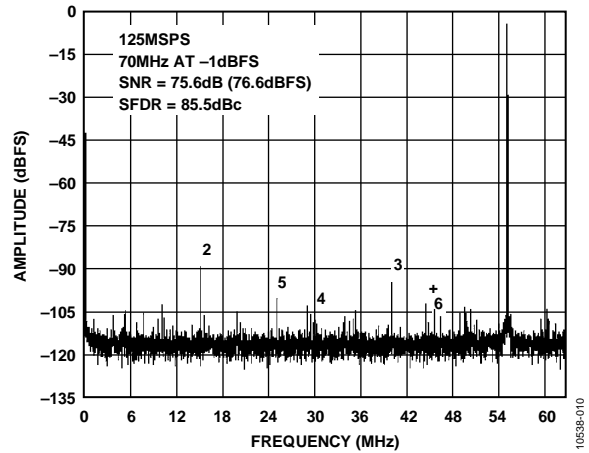

Figure 10. Single-Tone 16k FFT with $f_{IN} = 70 MHz$, $f_{SAMPLE} = 125 MSPS$, $V_{REF} = 1.0 V$

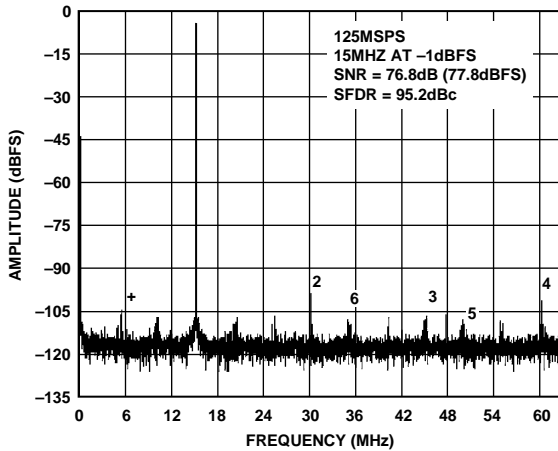

Figure 8. Single-Tone 16k FFT with $f_{IN} = 15 MHz$, $f_{SAMPLE} = 125 MSPS$, $V_{REF} = 1.0 V$

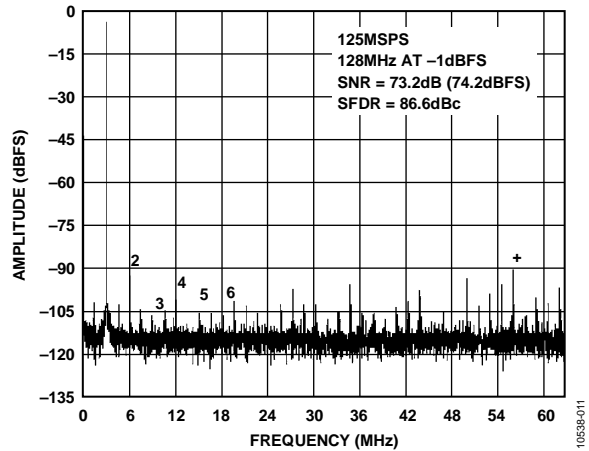

Figure 11. Single-Tone 16k FFT with $f_{IN} = 128 MHz$, $f_{SAMPLE} = 125 MSPS$, $V_{REF} = 1.0 V$

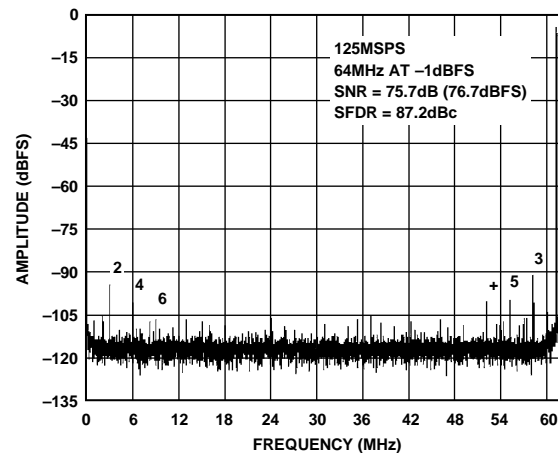

Figure 9. Single-Tone 16k FFT with $f_{IN} = 64 MHz$, $f_{SAMPLE} = 125 MSPS$, $V_{REF} = 1.0 V$

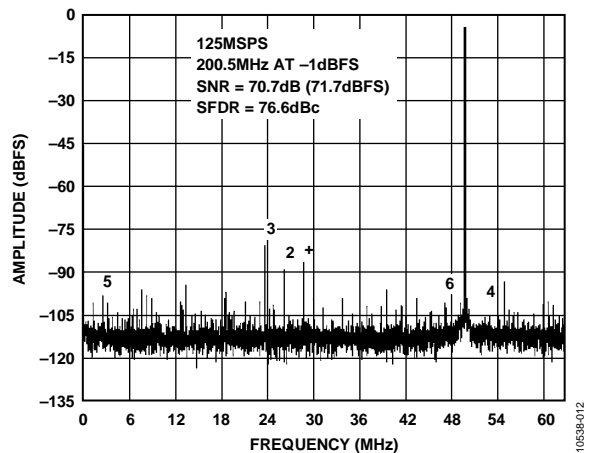

Figure 12. Single-Tone 16k FFT with $f_{IN} = 200.5 MHz$ at $f_{SAMPLE} = 125 MSPS$, $V_{REF} = 1.0 V$

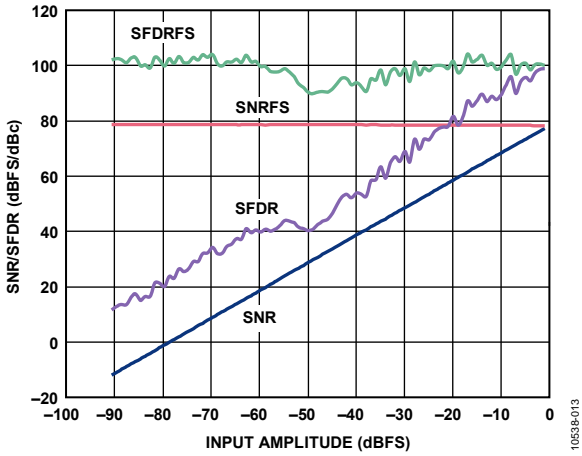

Figure 13. SNR/SFDR vs. Input Amplitude (A_{IN}), $f_{IN} = 9.7$ MHz, $f_{SAMPLE} = 125$ MSPS, $V_{REF} = 1.0$ V

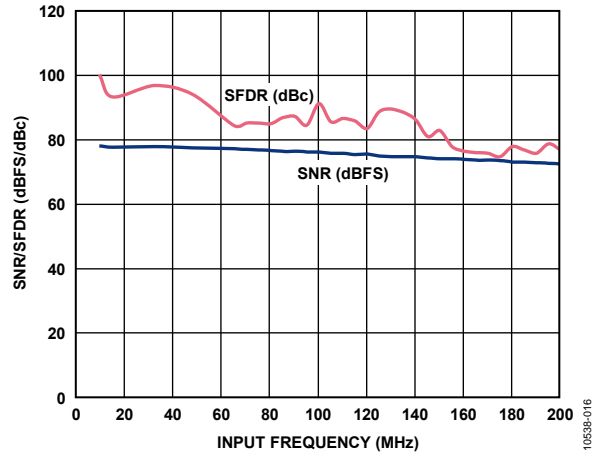

Figure 16. SNR/SFDR vs. f_{IN} , $f_{SAMPLE} = 125$ MSPS, Clock Divider = 8, $V_{REF} = 1.0$ V

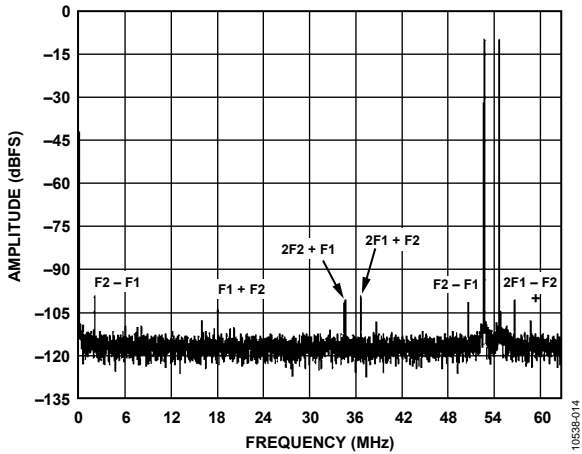

Figure 14. Two-Tone 16k FFT with $f_{IN1} = 70.5$ MHz and $f_{IN2} = 72.5$ MHz, $f_{SAMPLE} = 125$ MSPS, $V_{REF} = 1.0$ V

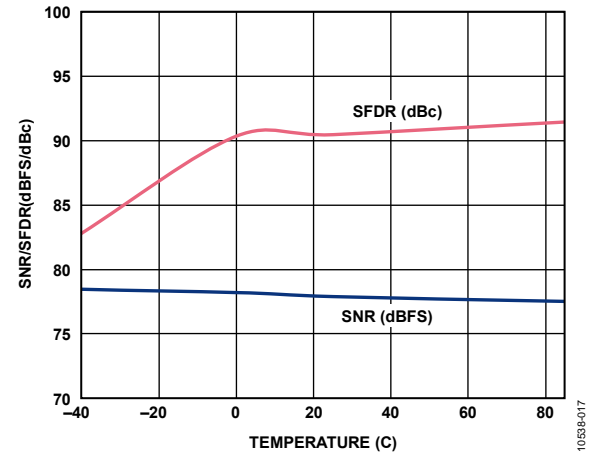

Figure 17. SNR/SFDR vs. Temperature, $f_{IN} = 9.7$ MHz, $f_{SAMPLE} = 125$ MSPS, $V_{REF} = 1.0$ V

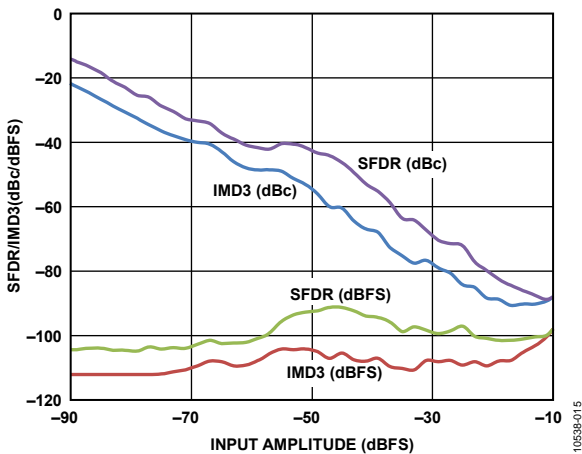

Figure 15. Two-Tone SFDR/IMD3 vs. Input Amplitude (A_{IN}) with $f_{IN1} = 70.5$ MHz and $f_{IN2} = 72.5$ MHz, $f_{SAMPLE} = 125$ MSPS, $V_{REF} = 1.0$ V

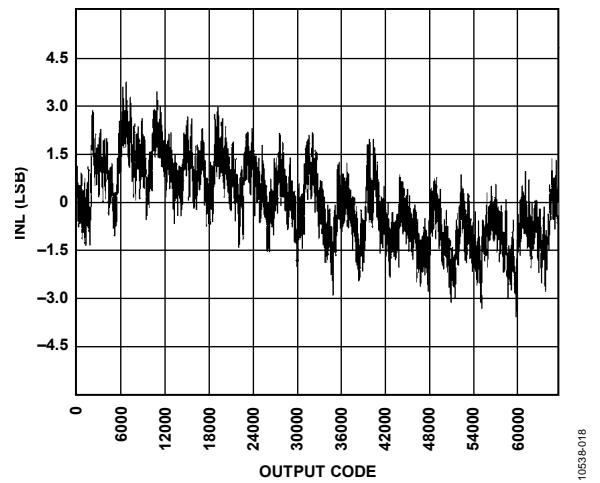

Figure 18. INL, $f_{IN} = 9.7$ MHz, $f_{SAMPLE} = 125$ MSPS, $V_{REF} = 1.0$ V

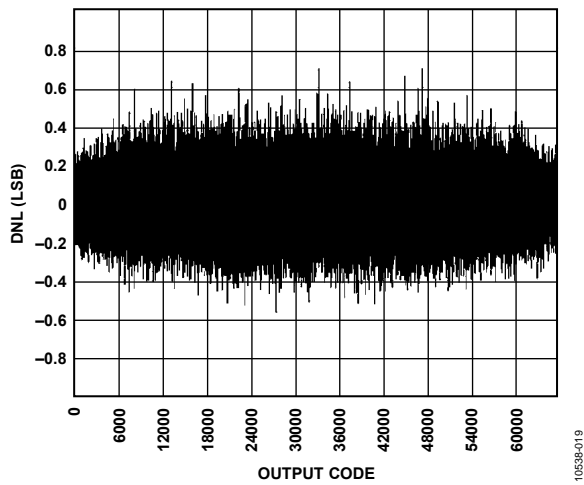

Figure 19. DNL, $f_{IN} = 9.7$ MHz, $f_{SAMPLE} = 125$ MSPS, $V_{REF} = 1.0$ V

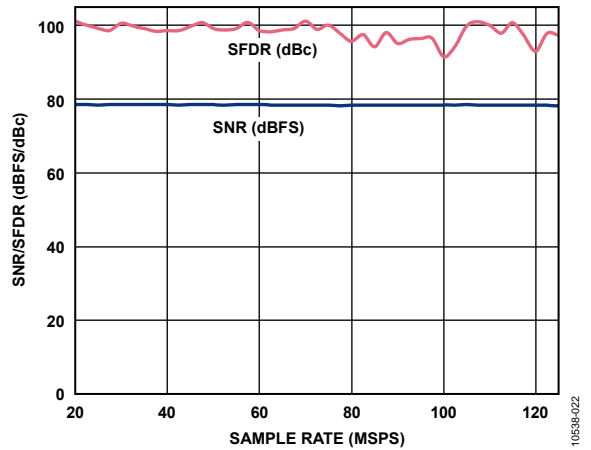

Figure 22. SNR/SFDR vs. Sample Rate, $f_{IN} = 9.7$ MHz, $V_{REF} = 1.0$ V

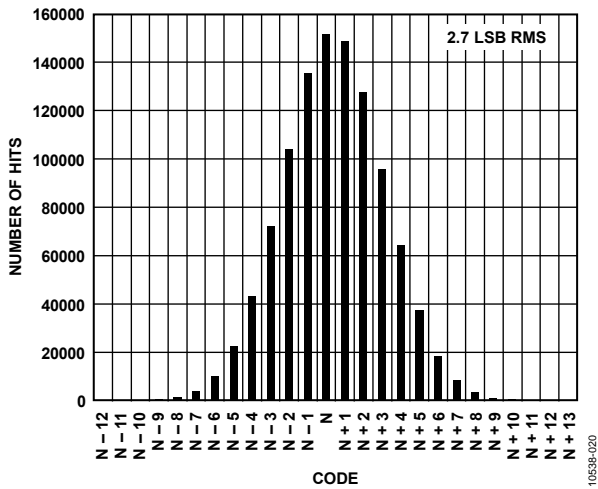

Figure 20. Input-Referred Noise Histogram, $f_{SAMPLE} = 125$ MSPS, $V_{REF} = 1.0$ V

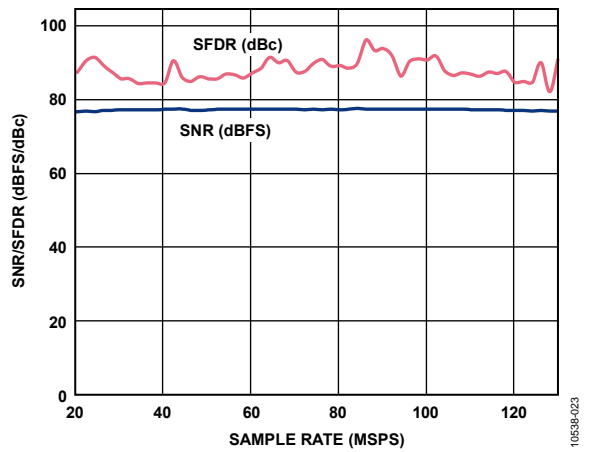

Figure 23. SNR/SFDR vs. Sample Rate, $f_{IN} = 64$ MHz, Clock Divider = 4, $V_{REF} = 1.0$ V

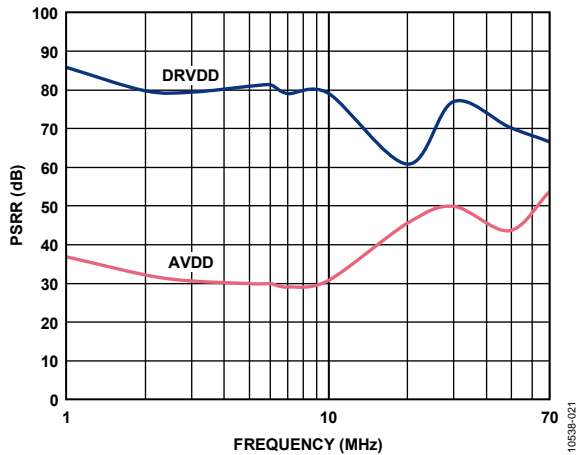

Figure 21. PSRR vs. Frequency, $f_{SAMPLE} = 125$ MSPS, $V_{REF} = 1.0$ V

$V_{REF} = 1.3\text{ V}$

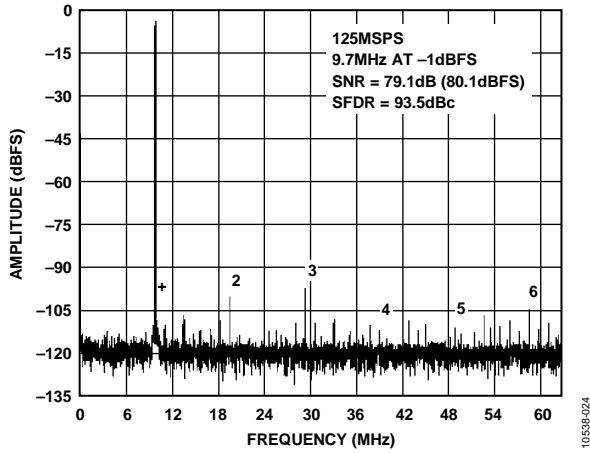

Figure 24. Single-Tone 16k FFT with $f_{IN} = 9.7\text{ MHz}$, $f_{SAMPLE} = 125\text{ MSPS}$, $V_{REF} = 1.3\text{ V}$

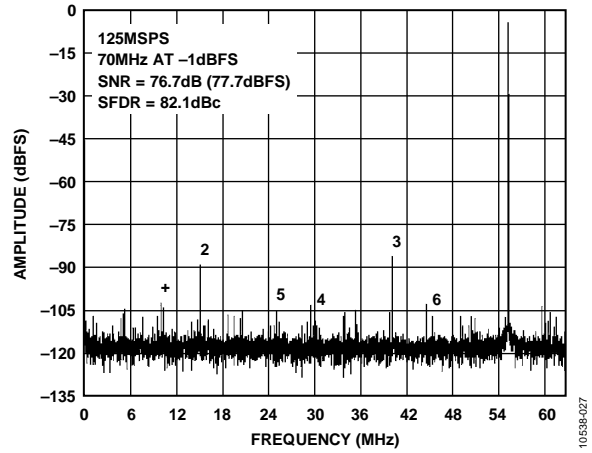

Figure 27. Single-Tone 16k FFT with $f_{IN} = 70\text{ MHz}$, $f_{SAMPLE} = 125\text{ MSPS}$, $V_{REF} = 1.3\text{ V}$

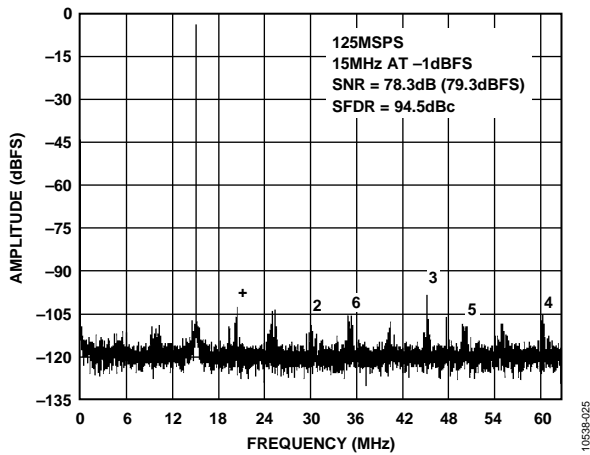

Figure 25. Single-Tone 16k FFT with $f_{IN} = 15\text{ MHz}$, $f_{SAMPLE} = 125\text{ MSPS}$, $V_{REF} = 1.3\text{ V}$

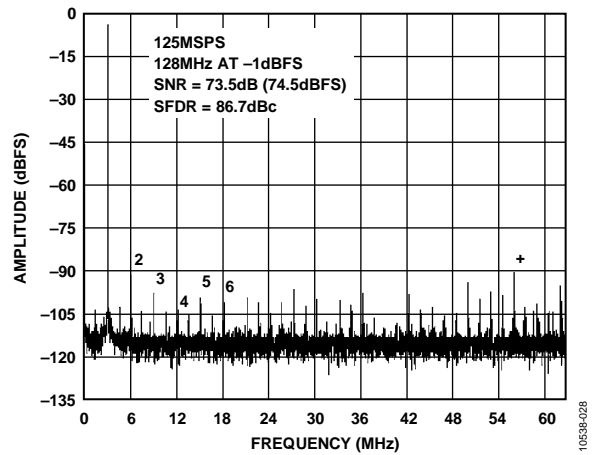

Figure 28. Single-Tone 16k FFT with $f_{IN} = 128\text{ MHz}$, $f_{SAMPLE} = 125\text{ MSPS}$, $V_{REF} = 1.3\text{ V}$

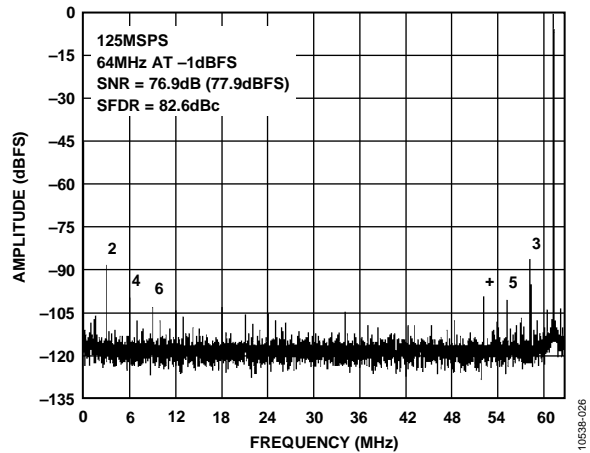

Figure 26. Single-Tone 16k FFT with $f_{IN} = 64\text{ MHz}$, $f_{SAMPLE} = 125\text{ MSPS}$, $V_{REF} = 1.3\text{ V}$

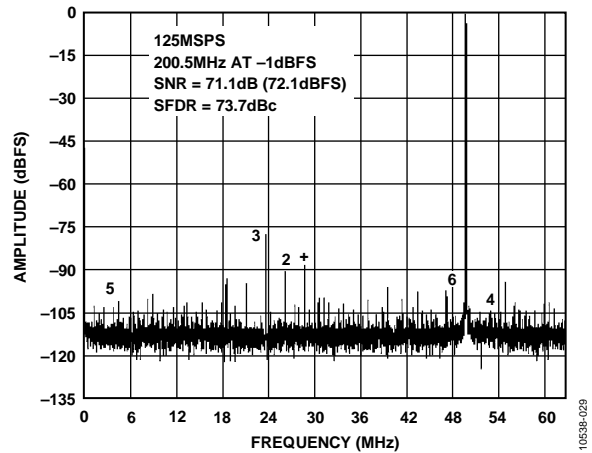

Figure 29. Single-Tone 16k FFT with $f_{IN} = 200.5\text{ MHz}$, $f_{SAMPLE} = 125\text{ MSPS}$, $V_{REF} = 1.3\text{ V}$

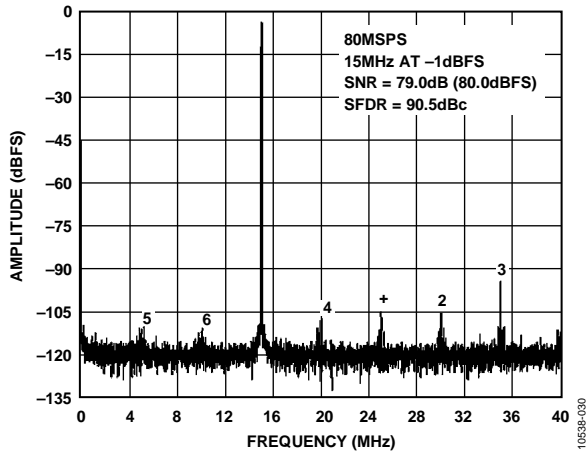

Figure 30. Single-Tone 16k FFT with $f_{IN} = 15$ MHz, $f_{SAMPLE} = 80$ MSPS, $V_{REF} = 1.3$ V

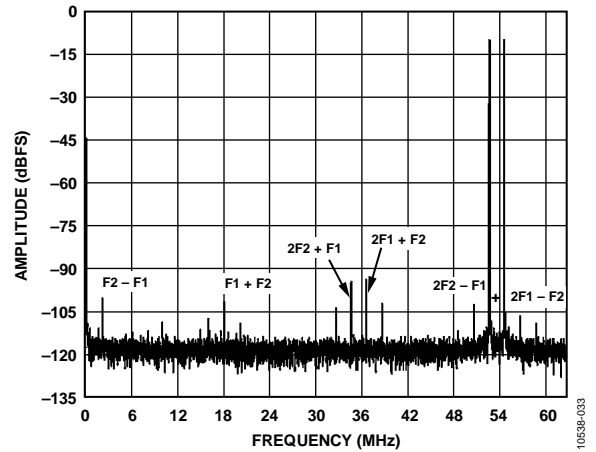

Figure 33. Two-Tone 16k FFT with $f_{IN1} = 70.5$ MHz and $f_{IN2} = 72.5$ MHz, $f_{SAMPLE} = 125$ MSPS, $V_{REF} = 1.3$ V

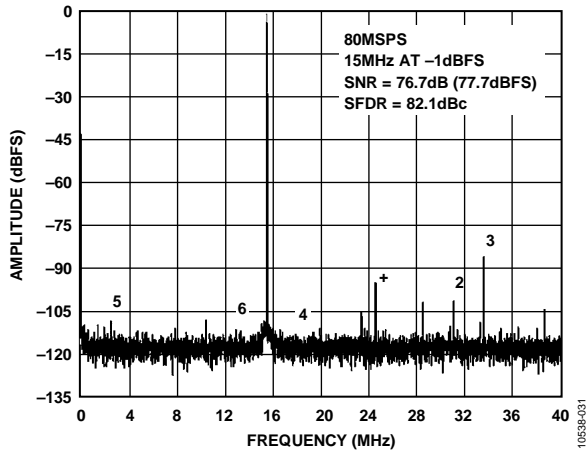

Figure 31. Single-Tone 16k FFT with $f_{IN} = 64.5$ MHz, $f_{SAMPLE} = 80$ MSPS, $V_{REF} = 1.3$ V

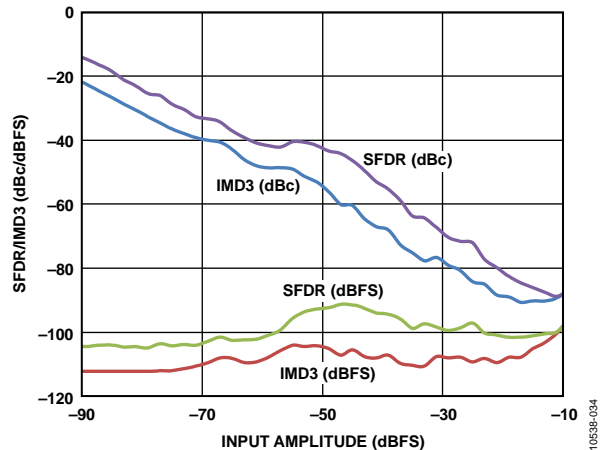

Figure 34. Two-Tone SFDR/IMD3 vs. Input Amplitude (AIN) with $f_{IN1} = 70.5$ MHz and $f_{IN2} = 72.5$ MHz, $f_{SAMPLE} = 125$ MSPS, $V_{REF} = 1.3$ V

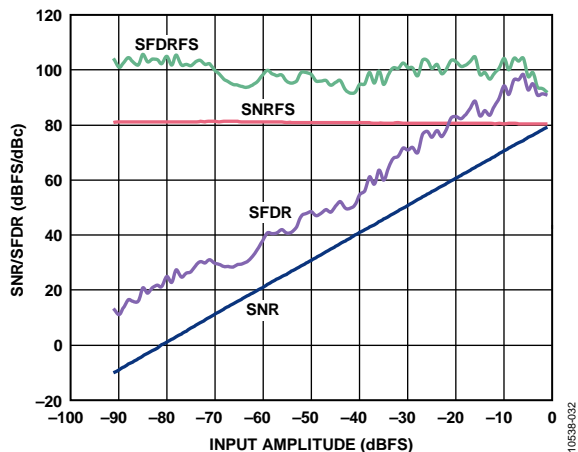

Figure 32. SNR/SFDR vs. Input Amplitude (AIN), $f_{IN} = 9.7$ MHz, $f_{SAMPLE} = 125$ MSPS, $V_{REF} = 1.3$ V

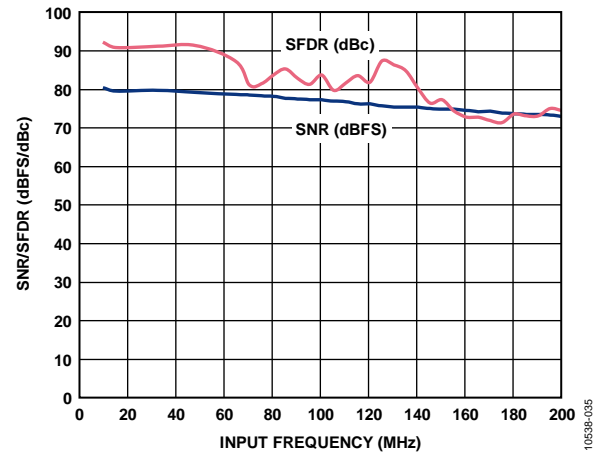

Figure 35. SNR/SFDR vs. f_{IN} , $f_{SAMPLE} = 125$ MSPS, Clock Divider = 8, $V_{REF} = 1.3$ V

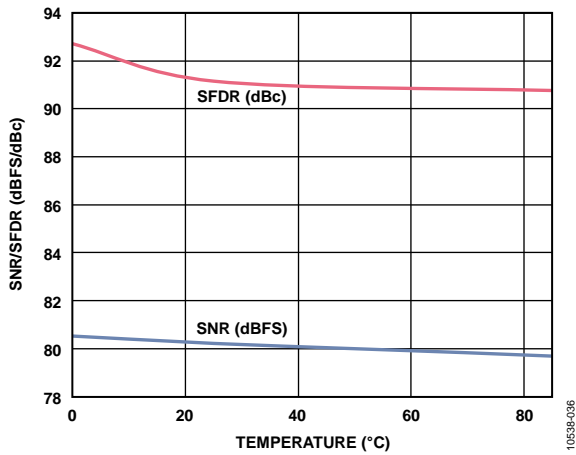

Figure 36. SNR/SFDR vs. Temperature, $f_{IN} = 9.7$ MHz, $f_{SAMPLE} = 125$ MSPS, $V_{REF} = 1.3$ V

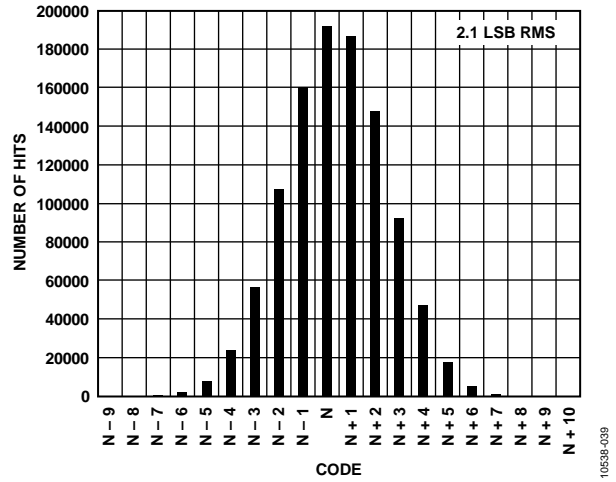

Figure 39. Input-Referred Noise Histogram, $f_{SAMPLE} = 125$ MSPS, $V_{REF} = 1.3$ V

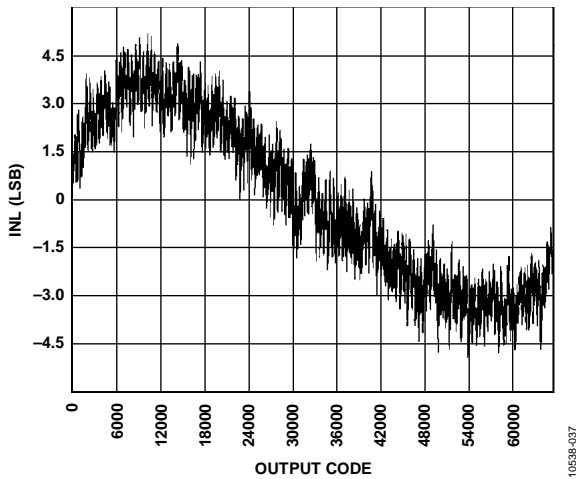

Figure 37. INL, $f_{IN} = 9.7$ MHz, $f_{SAMPLE} = 125$ MSPS, $V_{REF} = 1.3$ V

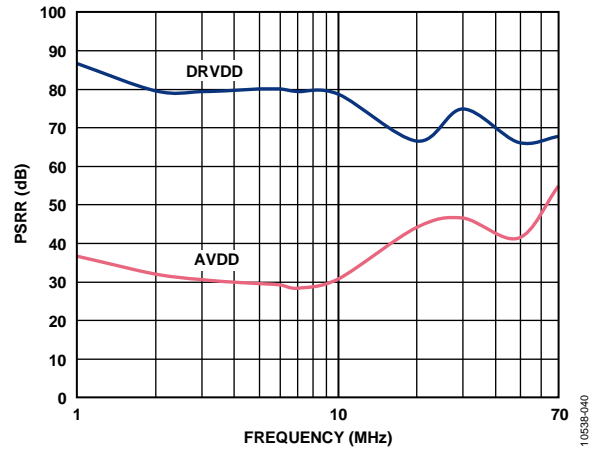

Figure 40. PSRR vs. Frequency, $f_{SAMPLE} = 125$ MSPS, $V_{REF} = 1.3$ V

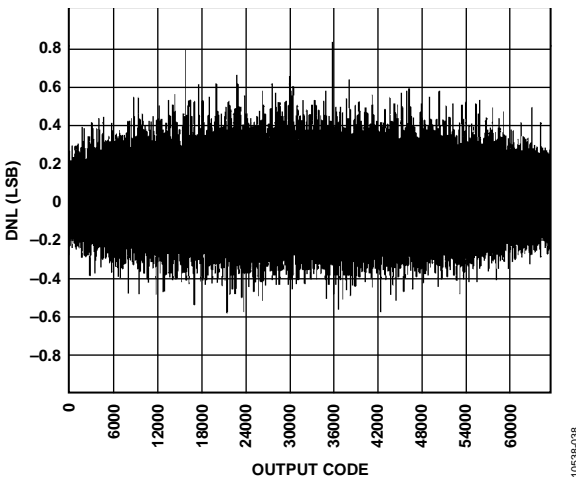

Figure 38. DNL, $f_{IN} = 9.7$ MHz, $f_{SAMPLE} = 125$ MSPS, $V_{REF} = 1.3$ V

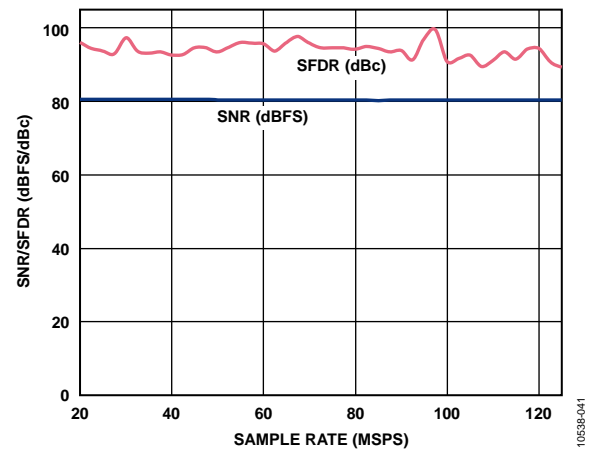

Figure 41. SNR/SFDR vs. Sample Rate, $f_{IN} = 9.7$ MHz, $V_{REF} = 1.3$ V

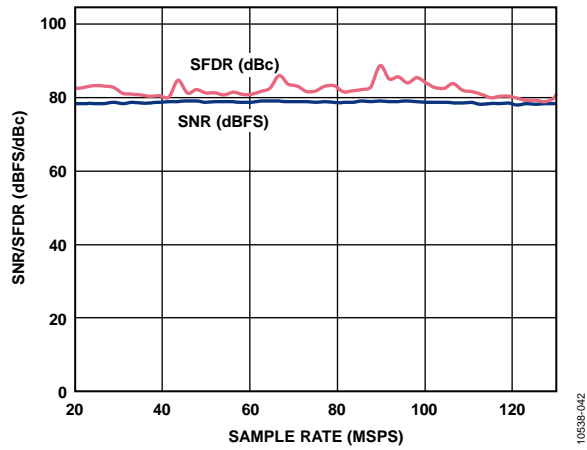

Figure 42. SNR/SFDR vs. Sample Rate, $f_{IN} = 64$ MHz, Clock Divider = 4, $V_{REF} = 1.3$ V

EQUIVALENT CIRCUITS

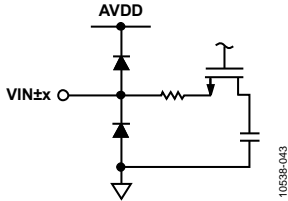

Figure 43. Equivalent Analog Input Circuit

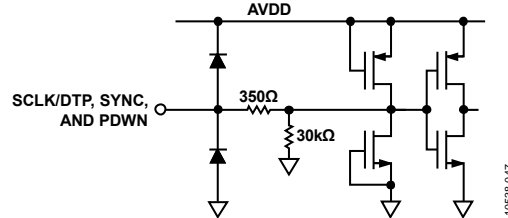

Figure 47. Equivalent SCLK/DTP, SYNC, and PDWN Input Circuit

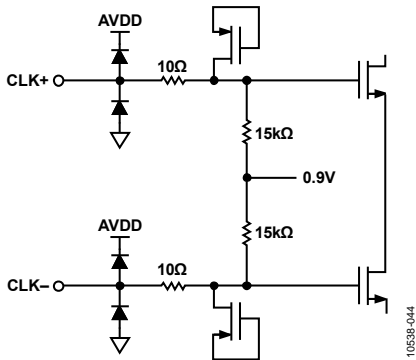

Figure 44. Equivalent Clock Input Circuit

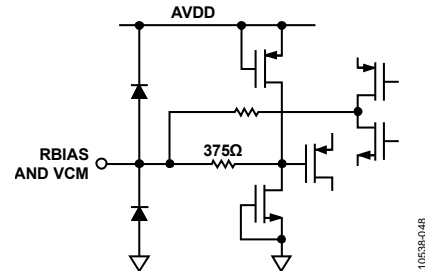

Figure 48. Equivalent RBIAS and VCM Circuit

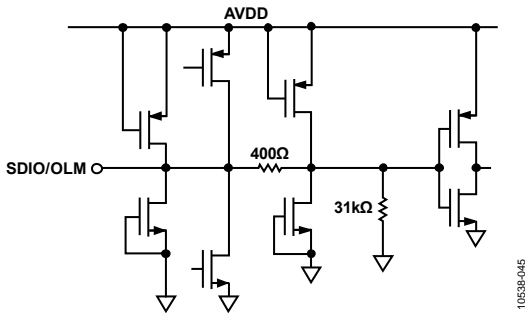

Figure 45. Equivalent SDIO/OLM Input Circuit

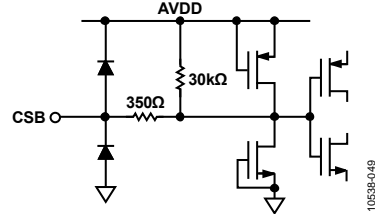

Figure 49. Equivalent CS Input Circuit

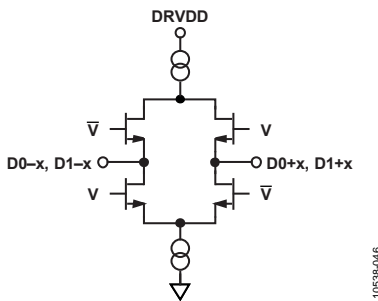

Figure 46. Equivalent Digital Output Circuit

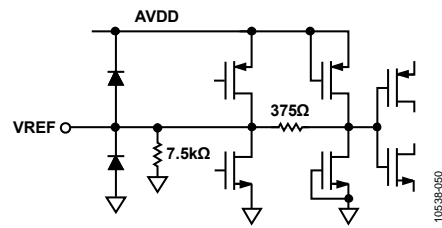

Figure 50. Equivalent VREF Circuit

THEORY OF OPERATION

The AD9653 is a multistage, pipelined ADC. Each stage provides sufficient overlap to correct for flash errors in the preceding stage. The quantized outputs from each stage are combined into a final 16-bit result in the digital correction logic. The serializer transmits this converted data in a 16-bit output. The pipelined architecture permits the first stage to operate with a new input sample while the remaining stages operate with preceding samples. Sampling occurs on the rising edge of the clock.

Each stage of the pipeline, excluding the last, consists of a low resolution flash ADC connected to a switched-capacitor DAC and an interstage residue amplifier (for example, a multiplying digital-to-analog converter (MDAC)). The residue amplifier magnifies the difference between the reconstructed DAC output and the flash input for the next stage in the pipeline. One bit of redundancy is used in each stage to facilitate digital correction of flash errors. The last stage simply consists of a flash ADC.

The output staging block aligns the data, corrects errors, and passes the data to the output buffers. The data is then serialized and aligned to the frame and data clocks.

ANALOG INPUT CONSIDERATIONS

The analog input to the AD9653 is a differential switched-capacitor circuit designed for processing differential input signals. This circuit can support a wide common-mode range while maintaining excellent performance. By using an input common-mode voltage of midsupply, users can minimize signal-dependent errors and achieve optimum performance.

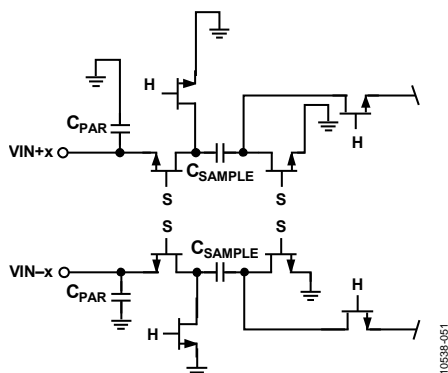

Figure 51. Switched-Capacitor Input Circuit

The clock signal alternately switches the input circuit between sample mode and hold mode (see Figure 51). When the input circuit is switched to sample mode, the signal source must be capable of charging the sample capacitors and settling within one-half of a clock cycle. A small resistor in series with each input can help reduce the peak transient current injected from

the output stage of the driving source. In addition, low Q inductors or ferrite beads can be placed on each leg of the input to reduce high differential capacitance at the analog inputs and therefore achieve the maximum bandwidth of the ADC. Such use of low Q inductors or ferrite beads is required when driving the converter front end at high IF frequencies. Either a differential capacitor or two single-ended capacitors can be placed on the inputs to provide a matching passive network. This ultimately creates a low-pass filter at the input to limit unwanted broadband noise. See the AN-742 Application Note, the AN-827 Application Note, and the Analog Dialogue article “Transformer-Coupled Front-End for Wideband A/D Converters” (Volume 39, April 2005) for more information. In general, the precise values depend on the application.

Input Common Mode

The analog inputs of the AD9653 are not internally dc-biased. Therefore, in ac-coupled applications, the user must provide this bias externally. Setting the device so that $V_{CM} = AVDD/2$ is recommended for optimum performance, but the device can function over a wider range with reasonable performance, as shown in Figure 52 and Figure 53.

An on-chip, common-mode voltage reference is included in the design and is available from the VCM pin. The VCM pin must be bypassed to ground by a 0.1 μF capacitor, as described in the Applications Information section.

Maximum SNR performance is achieved by setting the ADC to the largest span in a differential configuration. In the case of the AD9653, the input span is dependent on the reference voltage (see Table 11).

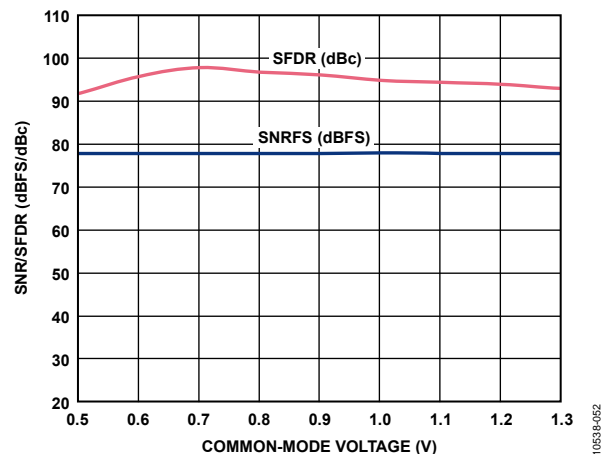

Figure 52. SNR/SFDR vs. Common-Mode Voltage, $f_{IN} = 9.7 \text{ MHz}$, $f_{SAMPLE} = 125 \text{ MSPS}$, $V_{REF} = 1.0 \text{ V}$

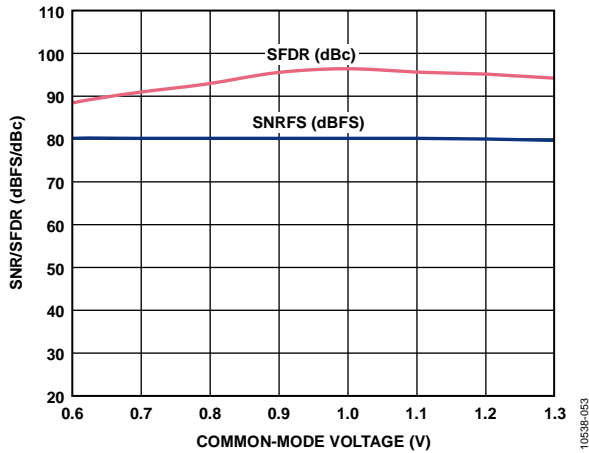

Figure 53. SNR/SFDR vs. Common-Mode Voltage, $f_{IN} = 9.7 \text{ MHz}$, $f_{SAMPLE} = 125 \text{ MSPS}$, $V_{REF} = 1.3 \text{ V}$

Differential Input Configurations

There are several ways to drive the AD9653 either actively or passively. However, optimum performance is achieved by driving the analog inputs differentially. Using a differential double balun configuration to drive the AD9653 provides excellent performance and a flexible interface to the ADC (see Figure 56) for baseband applications.

For applications where SNR is a key parameter, differential transformer coupling is the recommended input configuration (see Figure 57), because the noise performance of most amplifiers is not adequate to achieve the true performance of the AD9653.

Regardless of the configuration, the value of the shunt capacitor, C, is dependent on the input frequency and may need to be reduced or removed.

It is not recommended to drive the AD9653 inputs single-ended.

VOLTAGE REFERENCE

A stable and accurate voltage reference is built into the AD9653. VREF can be configured using either the internal 1.0 V reference, an externally applied 1.0 V to 1.3 V reference voltage, or using an external resistor divider applied to the internal reference to produce a reference voltage of the user’s choice. The various reference modes are summarized in the Internal Reference Connection section and the External Reference Operation section. The VREF pin should be externally bypassed to ground with a low ESR, 1.0 μF capacitor in parallel with a low ESR, 0.1 μF ceramic capacitor.

Internal Reference Connection

A comparator within the AD9653 detects the potential at the SENSE pin and configures the reference into one of three possible modes, which are summarized in Table 11. If SENSE is grounded, the reference amplifier switch is connected to the internal resistor divider (see Figure 54), setting the voltage at the VREF pin, V_{REF} , to 1.0 V. If SENSE is connected to an external resistor divider (see Figure 55), V_{REF} is defined as

$$V_{REF} = 0.5 \times \left(1 + \frac{R2}{R1} \right)$$

where:

$$7 \text{ k}\Omega \leq (R1 + R2) \leq 10 \text{ k}\Omega$$

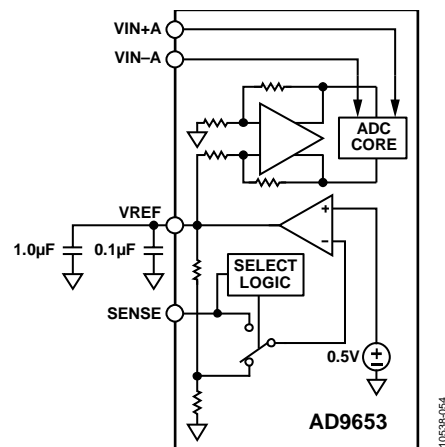

Figure 54. 1.0 V Internal Reference Configuration

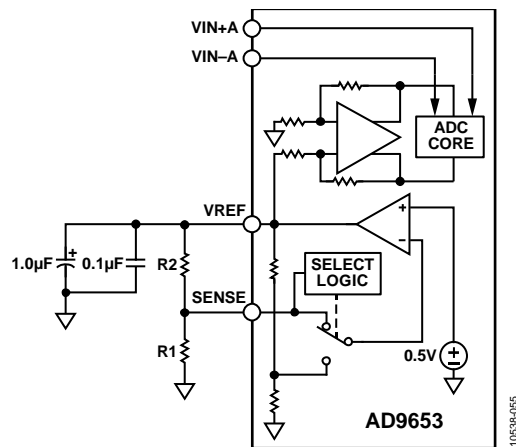

Figure 55. Programmable Internal Reference Configuration

Table 11. Reference Configuration Summary

Selected Mode	SENSE Voltage (V)	Resulting V_{REF} (V)	Resulting Differential Span (V p-p)
Fixed Internal Reference	AGND to 0.2	1.0 internal	2.0
Programmable Internal Reference	Tie to external R-divider (see Figure 55)	$0.5 \times (1 + R2/R1)$, example: $R1 = 3.5 \text{ k}\Omega$, $R2 = 5.6 \text{ k}\Omega$ for $V_{REF} = 1.3 \text{ V}$ ¹	$2 \times V_{REF}$
Fixed External Reference	AVDD	1.0 to 1.3 applied to external VREF pin ¹	2.0 to 2.6

¹ Normal operation for $V_{REF} = 1.3 \text{ V}$ is supported over the 0°C to 85°C temperature range.

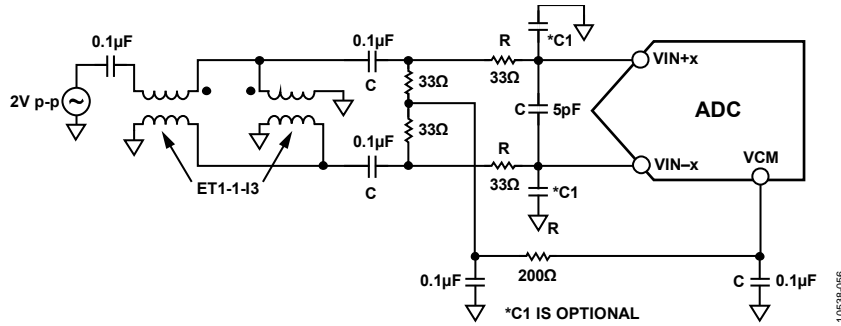

Figure 56. Differential Double Balun Input Configuration for Baseband Applications

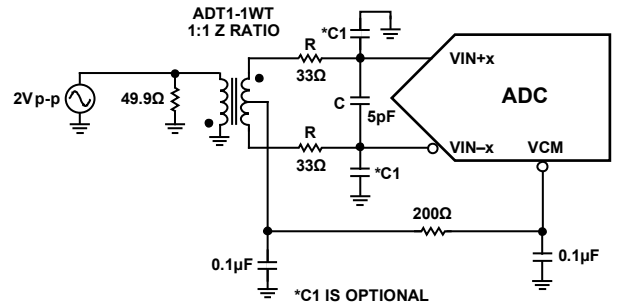

Figure 57. Differential Transformer-Coupled Configuration for Baseband Applications

If the internal reference of the AD9653 is used to drive multiple converters to improve gain matching, the loading of the reference by the other converters must be considered. Figure 58 and Figure 59 show how the internal reference voltage is affected by loading.

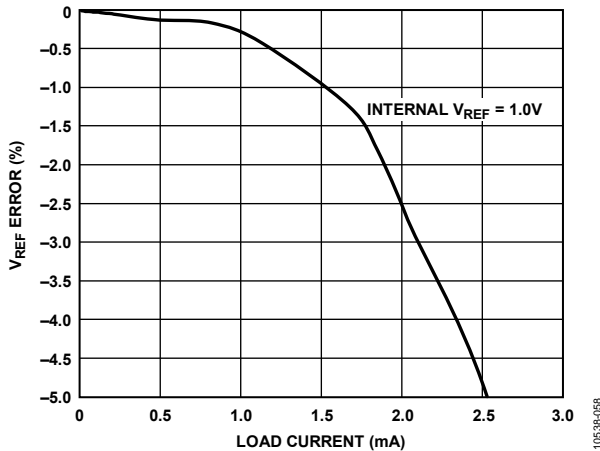

Figure 58. $V_{REF} = 1.0V$ Error vs. Load Current

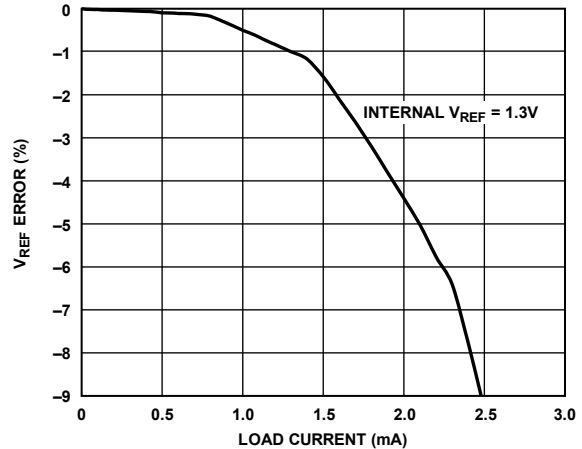
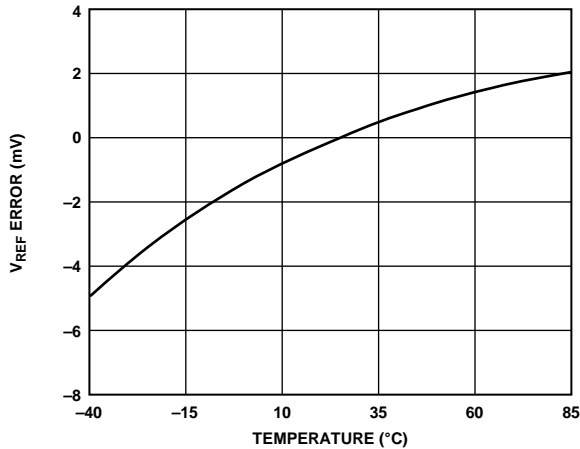
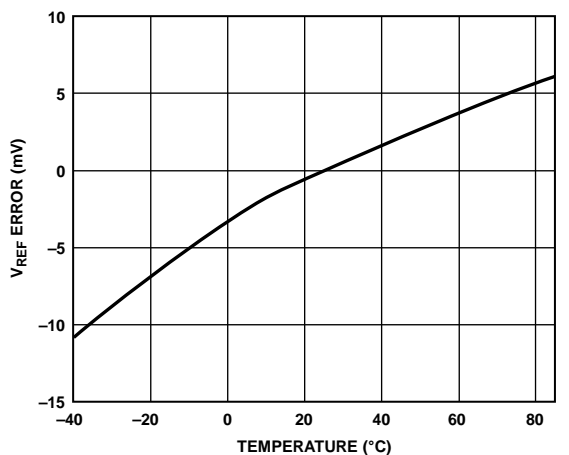

Figure 59. $V_{REF} = 1.3V$ Error vs. Load Current

External Reference Operation

The use of an external reference may be necessary to enhance the gain accuracy of the ADC or improve thermal drift characteristics. Figure 60 and Figure 61 show the typical drift characteristics of the internal reference in 1.0 V mode and programmable 1.3 V mode, respectively.

Figure 60. Typical $V_{REF} = 1.0$ V DriftFigure 61. Typical $V_{REF} = 1.3$ V Drift

When the SENSE pin is tied to AVDD, the internal reference is disabled, allowing the use of an external reference. An internal reference buffer loads the external reference with an equivalent 7.5 k Ω load (see Figure 50). The internal buffer generates the positive and negative full-scale references for the ADC core.

It is not recommended to leave the SENSE pin floating.

CLOCK INPUT CONSIDERATIONS

For optimum performance, clock the AD9653 sample clock inputs, CLK+ and CLK-, with a differential signal. The signal is typically ac-coupled into the CLK+ and CLK- pins via a transformer or capacitors. These pins are biased internally (see Figure 44) and require no external bias.

Clock Input Options

The AD9653 has a flexible clock input structure. The clock input can be a CMOS, LVDS, LVPECL, or sine wave signal. Regardless of the type of signal being used, clock source jitter is of the most concern, as described in the Jitter Considerations section.

Figure 62 and Figure 63 show two preferred methods for clocking the AD9653 (at clock rates up to 1 GHz prior to internal clock divider). A low jitter clock source is converted from a single-ended signal to a differential signal using either a radio frequency (RF) transformer or an RF balun.

The RF balun configuration is recommended for clock frequencies between 125 MHz and 1 GHz, and the RF transformer is recommended for clock frequencies from 20 MHz to 200 MHz. The antiparallel Schottky diodes across the transformer/balun secondary winding limit clock excursions into the AD9653 to approximately 0.8 V p-p differential.

This limit helps prevent the large voltage swings of the clock from feeding through to other portions of the AD9653 while preserving the fast rise and fall times of the signal that are critical to achieving low jitter performance. However, the diode capacitance comes into play at frequencies above 500 MHz. Care must be taken in choosing the appropriate signal limiting diode.

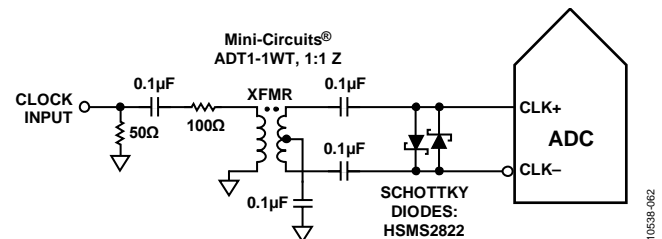

Figure 62. Transformer-Coupled Differential Clock (Up to 200 MHz)

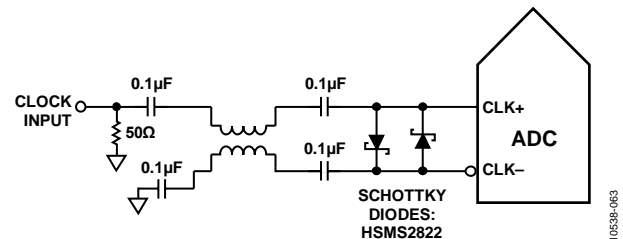

Figure 63. Balun-Coupled Differential Clock (Up to 1 GHz)

If a low jitter clock source is not available, another option is to ac couple a differential PECL signal to the sample clock input pins, as shown in Figure 64. The AD9510/AD9511/AD9512/AD9513/AD9514/AD9515/AD9516-4/AD9517-4 clock drivers offer excellent jitter performance.

A third option is to ac couple a differential LVDS signal to the sample clock input pins, as shown in Figure 65. The AD9510/AD9511/AD9512/AD9513/AD9514/AD9515/AD9516-4/AD9517-4 clock drivers offer excellent jitter performance.

In some applications, it may be acceptable to drive the sample clock inputs with a single-ended 1.8 V CMOS signal. In such applications, drive the CLK+ pin directly from a CMOS gate, and bypass the CLK- pin to ground with a 0.1 μ F capacitor (see Figure 66).

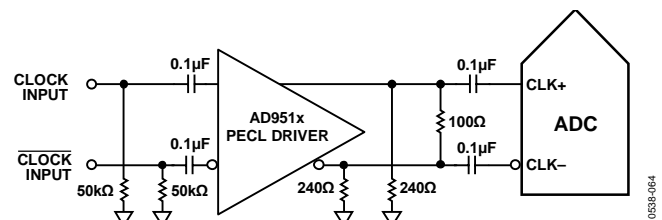

Figure 64. Differential PECL Sample Clock (Up to 1 GHz)

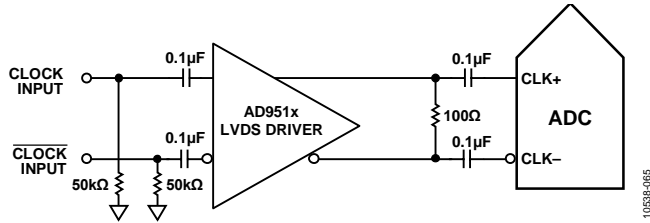
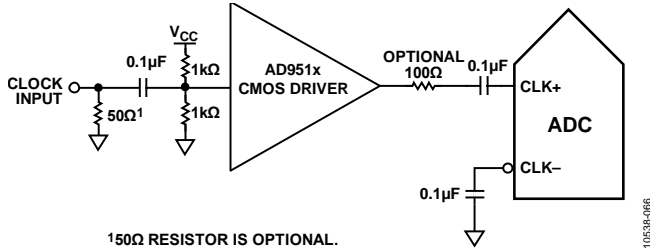

Figure 65. Differential LVDS Sample Clock (Up to 1 GHz)



150Ω RESISTOR IS OPTIONAL.

Figure 66. Single-Ended 1.8 V CMOS Input Clock (Up to 200 MHz)

Input Clock Divider

The AD9653 contains an input clock divider with the ability to divide the input clock by integer values between 1 and 8.

The AD9653 clock divider can be synchronized using the external SYNC input. Bit 0 and Bit 1 of Register 0x109 allow the clock divider to be resynchronized on every SYNC signal or only on the first SYNC signal after the register is written. A valid SYNC causes the clock divider to reset to its initial state. This synchronization feature allows multiple parts to have their clock dividers aligned to guarantee simultaneous input sampling.

Clock Duty Cycle

Typical high speed ADCs use both clock edges to generate a variety of internal timing signals and, as a result, may be sensitive to clock duty cycle. Commonly, a ±5% tolerance is required on the clock duty cycle to maintain dynamic performance characteristics.

The AD9653 contains a duty cycle stabilizer (DCS) that retimes the nonsampling (falling) edge, providing an internal clock signal with a nominal 50% duty cycle. This feature minimizes performance degradation in cases where the clock input duty cycle deviates from 50% greater than the specified ±5%. Noise and distortion performance are nearly flat for a wider range of duty cycles with the DCS on, as shown in Figure 67 and Figure 68.

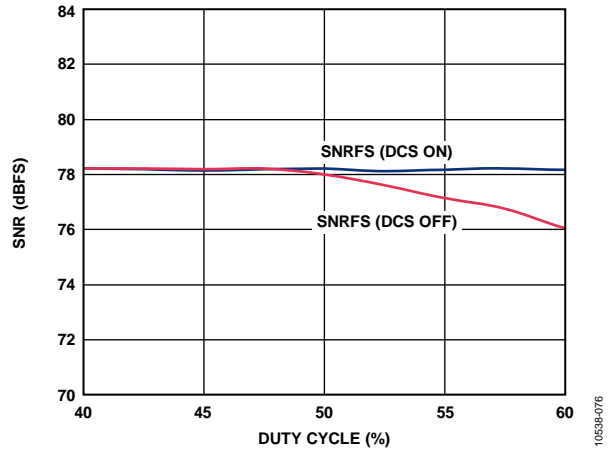

Figure 67. SNR vs. DCS On/Off, VREF = 1.0 V

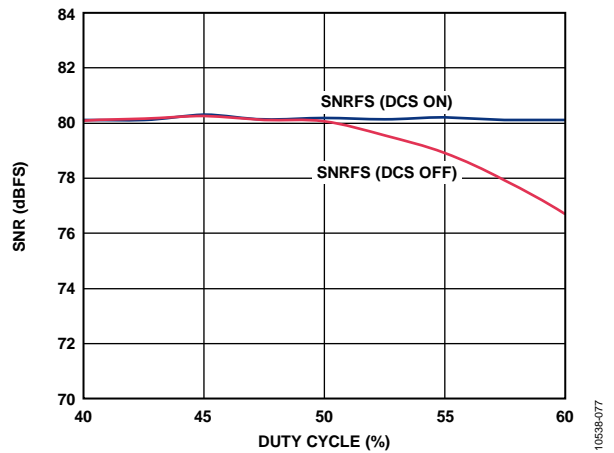

Figure 68. SNR vs. DCS On/Off, VREF = 1.3 V

Jitter in the rising edge of the input is still of concern and is not easily reduced by the internal stabilization circuit. The duty cycle control loop does not function for clock rates less than 20 MHz, nominally. The loop has a time constant associated with it that must be considered in applications in which the clock rate can change dynamically. A wait time of 1.5 µs to 5 µs is required after a dynamic clock frequency increase or decrease before the DCS loop is relocked to the input signal.

Jitter Considerations

High speed, high resolution ADCs are sensitive to the quality of the clock input. The degradation in SNR at a given input frequency (fA) due only to aperture jitter (tj) can be calculated by

$$SNR \text{ Degradation} = 20 \log_{10} \left(\frac{1}{2\pi \times f_A \times t_j} \right)$$

In this equation, the rms aperture jitter represents the root sum square of all jitter sources, including the clock input, analog input signal, and ADC aperture jitter specifications. IF undersampling applications are particularly sensitive to jitter (see Figure 69).

The clock input should be treated as an analog signal in cases where aperture jitter may affect the dynamic range of the AD9653. Power supplies for clock drivers should be separated from the

ADC output driver supplies to avoid modulating the clock signal with digital noise. Low jitter, crystal-controlled oscillators make the best clock sources. If the clock is generated from another type of source (by gating, dividing, or other methods), it should be retimed by the original clock at the last step.

Refer to the [AN-501 Application Note](#) and the [AN-756 Application Note](#) for more in-depth information about jitter performance as it relates to ADCs.

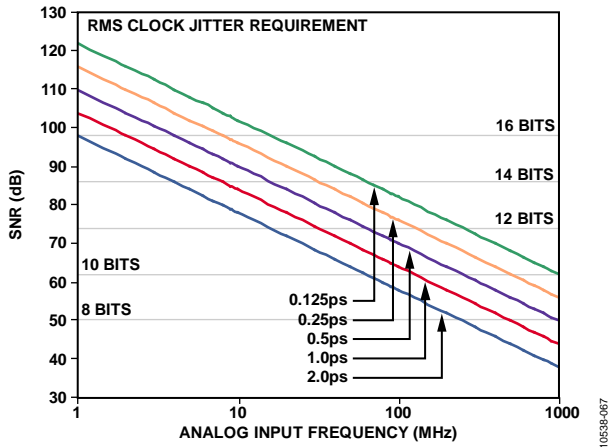

Figure 69. Ideal SNR vs. Input Frequency and Jitter

POWER DISSIPATION AND POWER-DOWN MODE

As shown in Figure 70, the power dissipated by the AD9653 is proportional to its sample rate. The digital power dissipation does not vary significantly because it is determined primarily by the DRVDD supply and bias current of the LVDS output drivers.

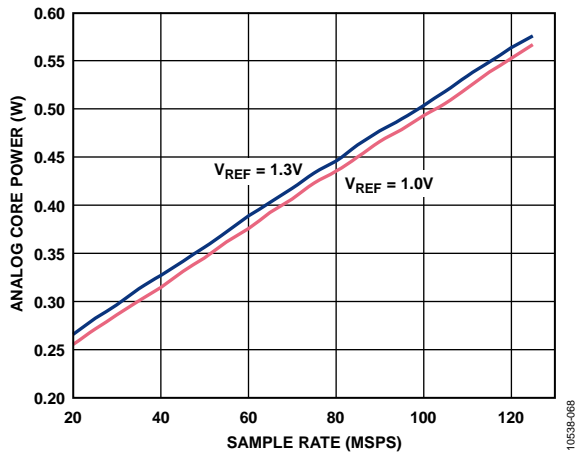

Figure 70. Analog Core Power vs. f_{SAMPLE} for $f_{IN} = 9.7$ MHz, Four Channels

The AD9653 is placed in power-down mode either by the SPI port or by asserting the PDWN pin high. In this state, the ADC typically dissipates 2 mW. During power-down, the output drivers are placed in a high impedance state. Asserting the PDWN pin low returns the AD9653 to its normal operating mode. Note that PDWN is referenced to the digital output driver supply (DRVDD) and should not exceed that supply voltage.

Low power dissipation in power-down mode is achieved by shutting down the reference, reference buffer, biasing networks, and clock. Internal capacitors are discharged when entering power-down mode and then must be recharged when returning to normal operation. As a result, wake-up time is related to the time spent in power-down mode, and shorter power-down cycles result in proportionally shorter wake-up times. When using the SPI port interface, the user can place the ADC in power-down mode or standby mode. Standby mode allows the user to keep the internal reference circuitry powered when faster wake-up times are required. See the Memory Map section for more details on using these features.

DIGITAL OUTPUTS AND TIMING

The AD9653 differential outputs conform to the ANSI-644 LVDS standard on default power-up. This can be changed to a low power, reduced signal option (similar to the IEEE 1596.3 standard) via the SPI. The LVDS driver current is derived on chip and sets the output current at each output equal to a nominal 3.5 mA. A 100 Ω differential termination resistor placed at the LVDS receiver inputs results in a nominal 350 mV swing (or 700 mV p-p differential) at the receiver.

When operating in reduced range mode, the output current is reduced to 2 mA. This results in a 200 mV swing (or 400 mV p-p differential) across a 100 Ω termination at the receiver.

The AD9653 LVDS outputs facilitate interfacing with LVDS receivers in custom ASICs and FPGAs for superior switching performance in noisy environments. Single point-to-point net topologies are recommended with a 100 Ω termination resistor placed as close to the receiver as possible. If there is no far-end receiver termination or there is poor differential trace routing, timing errors may result. To avoid such timing errors, it is recommended that the trace length be less than 24 inches and that the differential output traces be close together and at equal lengths. An example of the FCO and data stream with proper trace length and position is shown in Figure 71. Figure 72 shows the LVDS output timing example in reduced range mode.

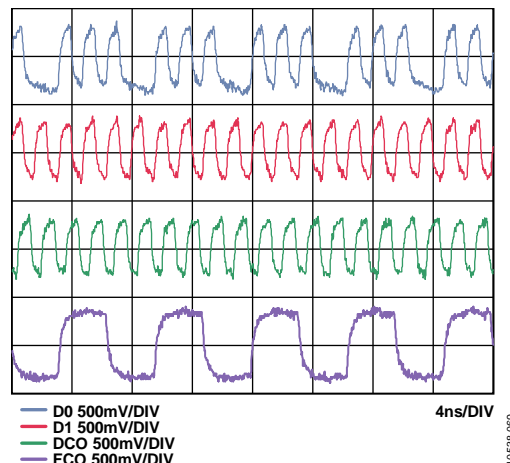

Figure 71. LVDS Output Timing Example in ANSI-644 Mode (Default)

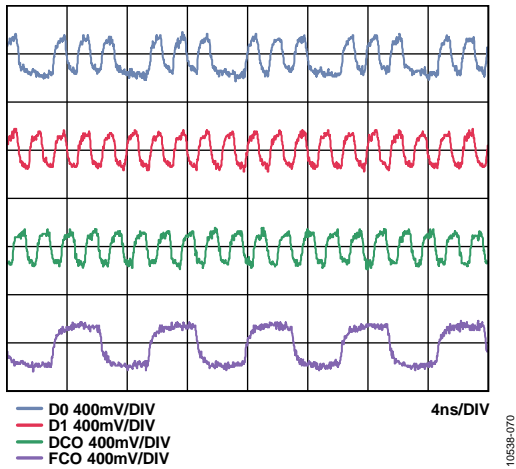

Figure 72. LVDS Output Timing Example in Reduced Range Mode

An example of the LVDS output using the ANSI-644 standard (default) data eye and a time interval error (TIE) jitter histogram with trace lengths less than 24 inches on standard FR-4 material is shown in Figure 73.

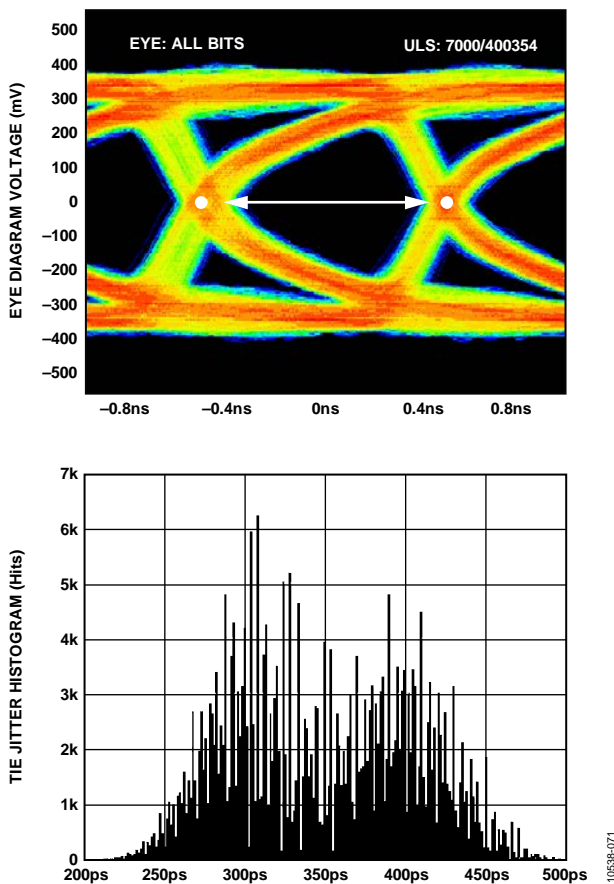

Figure 73. Data Eye for LVDS Outputs in ANSI-644 Mode with Trace Lengths Less than 24 Inches on Standard FR-4 Material, External 100 Ω Far-End Termination Only

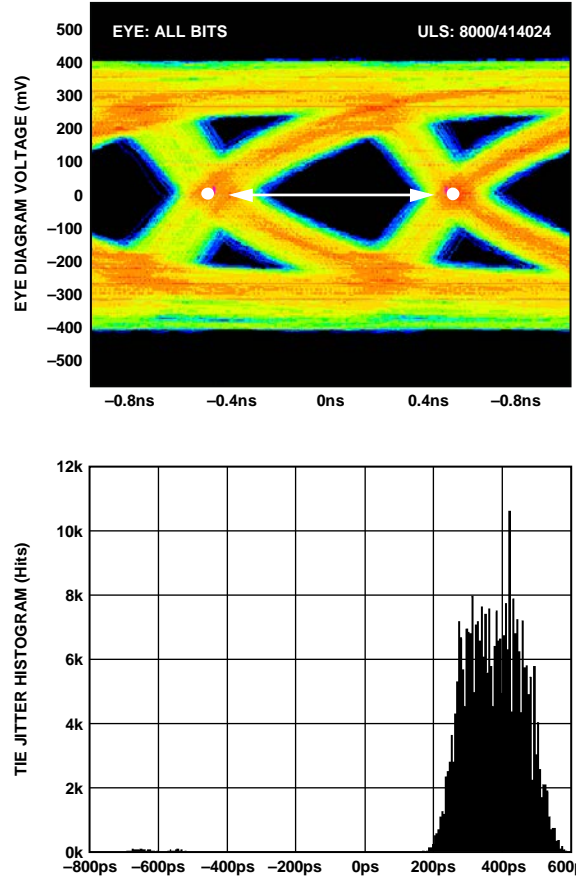

Figure 74. Data Eye for LVDS Outputs in ANSI-644 Mode with Trace Lengths Greater than 24 Inches on Standard FR-4 Material, External 100 Ω Far-End Termination Only

Figure 74 shows an example of trace lengths exceeding 24 inches on standard FR-4 material. Notice that the TIE jitter histogram reflects the decrease of the data eye opening as the edge deviates from the ideal position.

It is the user’s responsibility to determine if the waveforms meet the timing budget of the design when the trace lengths exceed 24 inches. Additional SPI options allow the user to further increase the internal termination (increasing the current) of all four outputs to drive longer trace lengths. This can be achieved by programming Register 0x15. Even though this produces sharper rise and fall times on the data edges and is less prone to bit errors, the power dissipation of the DRVDD supply increases when this option is used.

The format of the output data is two’s complement by default. An example of the output coding format can be found in Table 12. To change the output data format to offset binary, see the Memory Map section.

Data from each ADC is serialized and provided on a separate channel in two lanes in DDR mode. The data rate for each serial stream is equal to 16 bits times the sample clock rate divided by the number of lanes, with a maximum of 1000 Mbps/lane [(16 bits × 125 MSPS)/2 = 1000 Mbps/lane]. The maximum allowable output data rate is 1 Gbps/lane. If one-lane mode is used, the data rate doubles for a given sample rate. To stay within the maximum data rate of 1 Gbps/lane, the sample rate is limited to a maximum of 62.5 MSPS in one-lane output mode. The lowest typical conversion rate is 20 MSPS.

Two output clocks are provided to assist in capturing data from the AD9653. The DCO is used to clock the output data and is equal to four times the sample clock (CLK) rate for the default mode of operation. Data is clocked out of the AD9653 and must be captured on the rising and falling edges of the DCO that supports double data rate (DDR) capturing. The FCO is used to signal the start of a new output byte and is equal to the sample clock rate in 1× frame mode. See the Timing Diagrams section for more information.

When the SPI is used, the DCO phase can be adjusted in 60° increments relative one data cycle (30° relative to one DCO cycle). This enables the user to refine system timing margins if required. The default DCO+ and DCO– timing, as shown in Figure 2, is 180° relative to one data cycle (90° relative to one DCO cycle).

In default mode, as shown in Figure 2, the MSB is first in the data output serial stream. This can be inverted so that the LSB is first in the data output serial stream by using the SPI.

There are 12 digital output test pattern options available that can be initiated through the SPI. This is a useful feature when validating receiver capture and timing. Refer to Table 13 for the output bit sequencing options available. Some test patterns have two serial sequential words and can be alternated in various ways, depending on the test pattern chosen. Note that some patterns do not adhere to the data format select option. In addition, custom user-defined test patterns can be assigned in the 0x19, 0x1A, 0x1B, and 0x1C register addresses.

Table 12. Digital Output Coding

Input (V)	Condition (V)	Offset Binary Output Mode	Twos Complement Mode
VIN+ – VIN–	< –VREF – 0.5 LSB	0000 0000 0000 0000	1000 0000 0000 0000
VIN+ – VIN–	–VREF	0000 0000 0000 0000	1000 0000 0000 0000
VIN+ – VIN–	0 V	1000 0000 0000 0000	0000 0000 0000 0000
VIN+ – VIN–	+VREF – 1.0 LSB	1111 1111 1111 1111	0111 1111 1111 1111
VIN+ – VIN–	> +VREF – 0.5 LSB	1111 1111 1111 1111	0111 1111 1111 1111

Table 13. Flexible Output Test Modes

Output Test Mode Bit Sequence	Pattern Name	Digital Output Word 1	Digital Output Word 2	Subject to Data Format Select	Notes
0000	Off (default)	N/A	N/A	N/A	
0001	Midscale short	1000 0000 0000 0000 (16-bit)	N/A	Yes	Offset binary code shown
0010	+Full-scale short	1111 1111 1111 1111 (16-bit)	N/A	Yes	Offset binary code shown
0011	–Full-scale short	0000 0000 0000 0000 (16-bit)	N/A	Yes	Offset binary code shown
0100	Checkerboard	1010 1010 1010 1010 (16-bit)	0101 0101 0101 0101 (16-bit)	No	
0101	PN sequence long	N/A	N/A	Yes	PN23 ITU 0.150 $X^{23} + X^{18} + 1$
0110	PN sequence short	N/A	N/A	Yes	PN9 ITU 0.150 $X^9 + X^5 + 1$
0111	One-/zero-word toggle	1111 1111 1111 1111 (16-bit)	0000 0000 0000 0000 (16-bit)	No	
1000	User input	Register 0x19 to Register 0x1A	Register 0x1B to Register 0x1C	No	
1001	1-/0-bit toggle	1010 1010 1010 1000 (16-bit)	N/A	No	
1010	1× sync	0000 0001 1111 1100 (16-bit)	N/A	No	
1011	One bit high	1000 0000 0000 0000 (16-bit)	N/A	No	Pattern associated with the external pin
1100	Mixed frequency	1010 0001 1001 1100 (16-bit)	N/A	No	

The pseudorandom number (PN) sequence short pattern produces a pseudorandom bit sequence that repeats itself every $2^9 - 1$ or 511 bits. A description of the PN sequence and how it is generated can be found in Section 5.1 of the ITU-T 0.150 (05/96) standard. The seed value is all 1s (see Table 14 for the initial values). The output is a parallel representation of the serial PN9 sequence in MSB-first format. The first output word is the first 16 bits of the PN9 sequence in MSB aligned form.

The PN sequence long pattern produces a pseudorandom bit sequence that repeats itself every $2^{23} - 1$ or 8,388,607 bits. A description of the PN sequence and how it is generated can be found in Section 5.6 of the ITU-T 0.150 (05/96) standard. The seed value is all 1s (see Table 14 for the initial values) and the [AD9653](#) inverts the bit stream with relation to the ITU standard. The output is a parallel representation of the serial PN23 sequence in MSB-first format. The first output word is the first 16 bits of the PN23 sequence in MSB aligned form.

Table 14. PN Sequence

Sequence	Initial Value	Next Three Output Samples (MSB First) Twos Complement
PN Sequence Short	0x7F83	0x5F17, 0xB209, 0xCED1
PN Sequence Long	0x7FFF	0x7E00, 0x807C, 0x801F

Consult the Memory Map section for information on how to change these additional digital output timing features through the SPI.

SDIO/OLM Pin

For applications that do not require SPI mode operation, the CSB pin is tied to AVDD, and the SDIO/OLM pin controls the output lane mode according to Table 15.

Note that, when the CSB pin is tied to AVDD, the [AD9653](#) DCS is on by default and remains on unless the part is placed in SPI mode and controlled via the SPI. Refer to the Clock Duty Cycle section for more information on the DCS.

For applications where the SDIO/OLM pin is not used, CSB should be tied to AVDD. When using the one-lane mode, the conversion rate should be ≤ 62.5 MSPS to meet the maximum output rate of 1 Gbps.

Table 15. Output Lane Mode Pin Settings

OLM Pin Voltage	Output Mode
AVDD (Default)	Two-lane. 1× frame, 16-bit serial output
GND	One-lane. 1× frame, 16-bit serial output

SCLK/DTP Pin

The SCLK/DTP pin is used to select the digital test pattern (DTP) for applications that do not require SPI mode operation. This pin can enable a single digital test pattern if it and the CSB pin are held high during device power-up. When SCLK/DTP is tied to AVDD, the ADC channel outputs shift out the following pattern: 1000 0000 0000 0000. The FCO and DCO function normally while all channels shift out the repeatable test pattern. This pattern allows the user to perform timing alignment adjustments among the FCO, DCO, and output data. This pin has an internal 10 kΩ resistor to GND. It can be left unconnected.

Table 16. Digital Test Pattern Pin Settings

Selected DTP	DTP Voltage	Resulting D0±x and D1±x
Normal Operation DTP	10 kΩ to AGND AVDD	Normal operation 1000 0000 0000 0000

Additional and custom test patterns can also be observed when commanded from the SPI port. Consult the Memory Map section for information about the options available.

CSB Pin

The CSB pin should be tied to AVDD for applications that do not require SPI mode operation. By tying CSB high, all SCLK and SDIO information is ignored.

Note that when the CSB pin is tied to AVDD, the [AD9653](#) DCS is on by default and remains on unless the part is placed in SPI mode and controlled via the SPI. Refer to the Clock Duty Cycle section for more information on the DCS.

RBIAS Pin

To set the internal core bias current of the ADC, place a 10.0 kΩ, 1% tolerance resistor to ground at the RBIAS pin.

OUTPUT TEST MODES

The output test options are described in Table 13 and controlled by the output test mode bits at Address 0x0D. When an output test mode is enabled, the analog section of the ADC is disconnected from the digital back-end blocks and the test pattern is run through the output formatting block. Some of the test patterns are subject to output formatting, and some are not. The PN generators from the PN sequence tests can be reset by setting Bit 4 or Bit 5 of Register 0x0D. These tests can be performed with or without an analog signal (if present, the analog signal is ignored), but they do require an encode clock. For more information, see the [AN-877 Application Note, Interfacing to High Speed ADCs via SPI](#).

SERIAL PORT INTERFACE (SPI)

The AD9653 serial port interface (SPI) allows the user to configure the converter for specific functions or operations through a structured register space provided inside the ADC. The SPI offers the user added flexibility and customization, depending on the application. Addresses are accessed via the serial port and can be written to or read from via the port. Memory is organized into bytes that can be further divided into fields, which are documented in the Memory Map section. For detailed operational information, see the [AN-877 Application Note, Interfacing to High Speed ADCs via SPI](#).

CONFIGURATION USING THE SPI

Three pins define the SPI of this ADC: the SCLK pin, the SDIO pin, and the CSB pin (see Table 17). The SCLK (a serial clock) is used to synchronize the read and write data presented from and to the ADC. The SDIO (serial data input/output) is a dual-purpose pin that allows data to be sent to and read from the internal ADC memory map registers. The CSB (chip select bar) is an active low control that enables or disables the read and write cycles.

Table 17. Serial Port Interface Pins

Pin	Function
SCLK	Serial clock. The serial shift clock input, which is used to synchronize serial interface reads and writes.
SDIO	Serial data input/output. A dual-purpose pin that typically serves as an input or an output, depending on the instruction being sent and the relative position in the timing frame.
CSB	Chip select bar. An active low control that gates the read and write cycles.

The falling edge of the CSB, in conjunction with the rising edge of the SCLK, determines the start of the framing. An example of the serial timing and its definitions can be found in Figure 75 and Table 7.

Other modes involving the CSB are available. The CSB can be held low indefinitely, which permanently enables the device; this is called streaming. The CSB can stall high between bytes to allow for additional external timing. When CSB is tied high, SPI functions are placed in high impedance mode. This mode turns on any SPI pin secondary functions.

During an instruction phase, a 16-bit instruction is transmitted. Data follows the instruction phase, and its length is determined by the W0 and W1 bits.

In addition to word length, the instruction phase determines whether the serial frame is a read or write operation, allowing the serial port to be used both to program the chip and to read the contents of the on-chip memory. The first bit of the first byte in a multibyte serial data transfer frame indicates whether a read command or a write command is issued. If the instruction is a readback operation, performing a readback causes the serial data input/output (SDIO) pin to change direction from an input to an output at the appropriate point in the serial frame.

All data is composed of 8-bit words. Data can be sent in MSB-first mode or in LSB-first mode. MSB-first mode is the default on power-up and can be changed via the SPI port configuration register. For more information about this and other features, see the [AN-877 Application Note, Interfacing to High Speed ADCs via SPI](#).

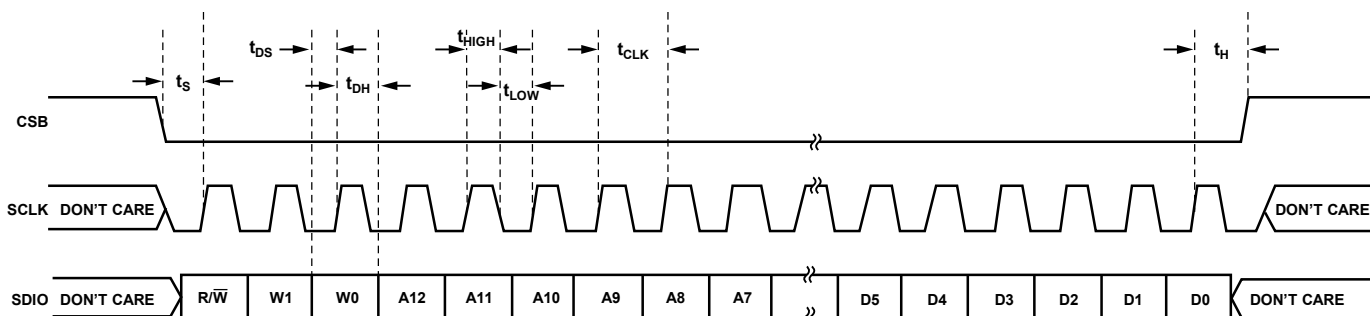

Figure 75. Serial Port Interface Timing Diagram

HARDWARE INTERFACE

The pins described in Table 17 comprise the physical interface between the user programming device and the serial port of the [AD9653](#). The SCLK pin and the CSB pin function as inputs when using the SPI interface. The SDIO pin is bidirectional, functioning as an input during write phases and as an output during readback.

The SPI interface is flexible enough to be controlled by either FPGAs or microcontrollers. One method for SPI configuration is described in detail in the [AN-812 Application Note, Micro-controller-Based Serial Port Interface \(SPI\) Boot Circuit](#).

The SPI port should not be active during periods when the full dynamic performance of the converter is required. Because the SCLK signal, the CSB signal, and the SDIO signal are typically asynchronous to the ADC clock, noise from these signals can degrade converter performance. If the on-board SPI bus is used for other devices, it may be necessary to provide buffers between this bus and the [AD9653](#) to prevent these signals from transitioning at the converter inputs during critical sampling periods.

Some pins serve a dual function when the SPI interface is not being used. When the pins are strapped to DRVDD or ground during device power-on, they are associated with a specific function. Table 15 and Table 16 describe the strappable functions supported on the [AD9653](#).

CONFIGURATION WITHOUT THE SPI

In applications that do not interface to the SPI control registers, the SDIO/OLM pin, the SCLK/DTP pin, and the PDWN pin serve as standalone CMOS-compatible control pins. When the device is powered up, it is assumed that the user intends to use the pins as static control lines for the output lane mode, digital test

pattern, and power-down feature control. In this mode, CSB should be connected to AVDD, which disables the serial port interface.

Note that, when the CSB pin is tied to AVDD, the [AD9653](#) DCS is on by default and remains on unless the part is placed in SPI mode and controlled via the SPI. Refer to the Clock Duty Cycle section for more information on the DCS.

When the device is in SPI mode, the PDWN pin (if enabled) remains active. For SPI control of power-down, the PDWN pin should be set to its default state.

SPI ACCESSIBLE FEATURES

Table 18 provides a brief description of the general features that are accessible via the SPI. These features are described in detail in the [AN-877 Application Note, Interfacing to High Speed ADCs via SPI](#). The [AD9653](#) part-specific features are described in detail following Table 19, the external memory map register table.

Table 18. Features Accessible Using the SPI

Feature Name	Description
Power Mode	Allows the user to set either power-down mode or standby mode
Clock	Allows the user to set the clock divider, set the clock divider phase, and enable the sync
Offset	Allows the user to digitally adjust the converter offset
Test Input/Output	Allows the user to set test modes to have known data on output bits
Output Mode	Allows the user to set the output mode
Output Phase	Allows the user to set the output clock polarity

MEMORY MAP

READING THE MEMORY MAP REGISTER TABLE

Each row in the memory map register table has eight bit locations. The memory map is roughly divided into three sections: the chip configuration registers (Address 0x00 to Address 0x02); the device index and transfer registers (Address 0x04, Address 0x05, and Address 0xFF); and the global ADC functions registers, including setup, control, and test (Address 0x08 to Address 0x109).

The memory map register table (see Table 19) lists the default hexadecimal value for each hexadecimal address shown. The column with the heading Bit 7 (MSB) is the start of the default hexadecimal value given. For example, Address 0x05, the device index register, has a hexadecimal default value of 0x3F. This means that in Address 0x05, Bits[7:6] = 0, and the remaining Bits[5:0] = 1. This setting is the default channel index setting. The default value results in all ADC channels receiving the next write command. For more information on this function and others, see the [AN-877 Application Note, Interfacing to High Speed ADCs via SPI](#). This application note details the functions controlled by Register 0x00 to Register 0xFF. The remaining registers are documented in the Memory Map Register Descriptions section.

Open Locations

All address and bit locations that are not included in Table 19 are not currently supported for this device. Unused bits of a valid address location should be written with 0s. Writing to these locations is required only when part of an address location is open (for example, Address 0x05). If the entire address location is open or not listed in Table 19 (for example, Address 0x13), this address location should not be written.

Default Values

After the AD9653 is reset, critical registers are loaded with default values. The default values for the registers are given in the memory map register table, Table 19.

Logic Levels

An explanation of logic level terminology follows:

- “Bit is set” is synonymous with “bit is set to Logic 1” or “writing Logic 1 for the bit.”
- “Clear a bit” is synonymous with “bit is set to Logic 0” or “writing Logic 0 for the bit.”

Channel-Specific Registers

Some channel setup functions can be programmed differently for each channel. In these cases, channel address locations are internally duplicated for each channel. These registers and bits are designated in Table 19 as local. These local registers and bits can be accessed by setting the appropriate data channel bits (A, B, C, or D) and the clock channel DCO bit (Bit 5) and FCO bit (Bit 4) in Register 0x05. If all the bits are set, the subsequent write affects the registers of all channels and the DCO/FCO clock channels. In a read cycle, only one of the channels (A, B, C, or D) should be set to read one of the four registers. If all the bits are set during a SPI read cycle, the part returns the value for Channel A. Registers and bits designated as global in Table 19 affect the entire part or the channel features for which independent settings are not allowed between channels. The settings in Register 0x04 and Register 0x05 do not affect the global registers and bits.

MEMORY MAP REGISTER TABLE

The AD9653 uses a 3-wire interface and 16-bit addressing and, therefore, Bit 0 and Bit 7 in Register 0x00 are set to 0, and Bit 3 and Bit 4 are set to 1. When Bit 5 in Register 0x00 is set high,

the SPI enters a soft reset, where all of the user registers revert to their default values and Bit 2 is automatically cleared.

Table 19.

ADDR (Hex)	Parameter Name	Bit 7 (MSB)	Bit 6	Bit 5	Bit 4	Bit 3	Bit 2	Bit 1	Bit 0 (LSB)	Default Value (Hex)	Comments
Chip Configuration Registers											
0x00	SPI port configuration	0 = SDO active	LSB first	Soft reset	1 = 16-bit address	1 = 16-bit address	Soft reset	LSB first	0 = SDO active	0x18	The nibbles are mirrored so that LSB-first or MSB-first mode registers correctly. The default for ADCs is 16-bit mode.
0x01	Chip ID (global)	8-bit chip ID, Bits[7:0] AD9653 0xB5 = quad, 16-bit, 125 MSPS serial LVDS								0xB5	Unique chip ID used to differentiate devices; read only.
0x02	Chip grade (global)	Open	Speed grade ID[6:4] 110 = 125 MSPS			Open	Open	Open	Open		Unique speed grade ID used to differentiate graded devices; read only.
Device Index and Transfer Registers											
0x04	Device index	Open	Open			Data Channel D	Data Channel C	Data Channel B	Data Channel A	0x0F	Bits[3:0] must be set to the same value as Register 0x05 Bits[3:0]
0x05	Device index	Open	Open	Clock Channel DCO	Clock Channel FCO	Data Channel D	Data Channel C	Data Channel B	Data Channel A	0x3F	Bits are set to determine which device on chip receives the next write command. The default is all devices on chip.
0xFF	Transfer	Open	Open	Open	Open	Open	Open	Open	Initiate override	0x00	Set sample rate override.
Global ADC Function Registers											
0x08	Power modes (global)	Open	Open	External power-down pin function 0 = full power-down 1 = standby	Open	Open	Open	Power mode 00 = chip run 01 = full power-down 10 = standby 11 = reset		0x00	Determines various generic modes of chip operation.
0x09	Clock (global)	Open	Open	Open	Open	Open	Open	Open	Duty cycle stabilize 0 = on 1 = off	0x01	Turns duty cycle stabilizer on or off.

ADDR (Hex)	Parameter Name	Bit 7 (MSB)	Bit 6	Bit 5	Bit 4	Bit 3	Bit 2	Bit 1	Bit 0 (LSB)	Default Value (Hex)	Comments
0x0B	Clock divide (global)	Open	Open	Open	Open	Open	Clock divide ratio[2:0] 000 = divide by 1 001 = divide by 2 010 = divide by 3 011 = divide by 4 100 = divide by 5 101 = divide by 6 110 = divide by 7 111 = divide by 8			0x00	
0x0C	Enhancement control	Open	Open	Open	Open	Open	Chop mode 0 = off 1 = on	Open	Open	0x00	Enables/disables chop mode.
0x0D	Test mode (local except for PN sequence resets)	User input test mode 00 = single 01 = alternate 10 = single once 11 = alternate once (affects user input test mode only, Bits[3:0] = 1000)		Reset PN long gen	Reset PN short gen	Output test mode[3:0] (local) 0000 = off (default) 0001 = midscale short 0010 = positive FS 0011 = negative FS 0100 = alternating checkerboard 0101 = PN 23 sequence 0110 = PN 9 sequence 0111 = one/zero word toggle 1000 = user input 1001 = 1-/0-bit toggle 1010 = 1× sync 1011 = one bit high 1100 = mixed bit frequency				0x00	When set, the test data is placed on the output pins in place of normal data.
0x10	Offset adjust (local)	8-bit device offset adjustment [7:0] (local) Offset adjust in LSBs from +127 to -128 (twos complement format)								0x00	Device offset trim.
0x14	Output mode	Open	LVDS-ANSI/ LVDS-IEEE option 0 = LVDS-ANSI 1 = LVDS-IEEE reduced range link (global) see Table 20	Open	Open	Open	Output invert (local)	1	Output format 0 = offset binary 1 = twos complement (global)	0x03	Configures the outputs and the format of the data.
0x15	Output adjust	Open	Open	Output driver termination[1:0] 00 = none 01 = 200 Ω 10 = 100 Ω 11 = 100 Ω		Open	Open	Open	Output drive 0 = 1× drive 1 = 2× drive	0x00	Determines LVDS or other output properties.
0x16	Output phase	Open	Input clock phase adjust[6:4] (value is number of input clock cycles of phase delay) see Table 21			Output clock phase adjust[3:0] (0000 through 1011) see Table 22				0x03	On devices that use global clock divide, determines which phase of the divider output is used to supply the output clock. Internal latching is unaffected.
0x18	V _{REF}	Open	Open	Open	Open	Open	V _{REF} adjustment digital scheme[2:0] 000 = 1.0 V p-p (1.3 V p-p) 001 = 1.14 V p-p (1.48 V p-p) 010 = 1.33 V p-p (1.73 V p-p) 011 = 1.6 V p-p (2.08 V p-p) 100 = 2.0 V p-p (2.6 V p-p)			0x04	Selects internal V _{REF} . Values shown are for V _{REF} = 1.0 V (1.3 V).

ADDR (Hex)	Parameter Name	Bit 7 (MSB)	Bit 6	Bit 5	Bit 4	Bit 3	Bit 2	Bit 1	Bit 0 (LSB)	Default Value (Hex)	Comments
0x19	USER_PATT1_LSB (global)	B7	B6	B5	B4	B3	B2	B1	B0	0x00	User Defined Pattern 1 LSB.
0x1A	USER_PATT1_MSB (global)	B15	B14	B13	B12	B11	B10	B9	B8	0x00	User Defined Pattern 1 MSB.
0x1B	USER_PATT2_LSB (global)	B7	B6	B5	B4	B3	B2	B1	B0	0x00	User Defined Pattern 2 LSB.
0x1C	USER_PATT2_MSB (global)	B15	B14	B13	B12	B11	B10	B9	B8	0x00	User Defined Pattern 2 MSB.
0x21	Serial output data control (global)	LVDS output LSB first	SDR/DDR one-lane/two-lane, bitwise/bytewise[6:4] 000 = SDR two-lane, bitwise 001 = SDR two-lane, bytewise 010 = DDR two-lane, bitwise 011 = DDR two-lane, bytewise 100 = DDR one-lane, wordwise			Open	Select 2x frame	Serial output number of bits 00 = 16 bits		0x30	Serial stream control. Default causes MSB first and the native bit stream.
0x22	Serial channel status (local)	Open	Open	Open	Open	Open	Open	Channel output reset	Channel power-down	0x00	Used to power down individual sections of a converter.
0x100	Sample rate override	Open	Sample rate override enable	0	0	Open	Sample rate 000 = 20 MSPS 001 = 40 MSPS 010 = 50 MSPS 011 = 65 MSPS 100 = 80 MSPS 101 = 105 MSPS 110 = 125 MSPS		0x00	Sample rate override (requires transfer register, 0xFF).	
0x101	User Input/Output Control 2	Open	Open	Open	Open	Open	Open	Open	SDIO pull-down	0x00	Disables SDIO pull-down.
0x102	User Input/Output Control 3	Open	Open	Open	Open	VCM power-down	Open	Open	Open	0x00	VCM control.
0x109	Sync	Open	Open	Open	Open	Open	Open	Sync next only	Enable sync	0x00	

MEMORY MAP REGISTER DESCRIPTIONS

For additional information about functions controlled in Register 0x00 to Register 0xFF, see the [AN-877 Application Note, Interfacing to High Speed ADCs via SPI](#).

Device Index (Register 0x04, Register 0x05)

There are certain features in the map that can be set independently for each channel, whereas other features apply globally to all channels (depending on context) regardless of which are selected. The first four bits in Register 0x04 and Register 0x05 are used to select which individual data channels are affected. The output clock channels can be selected in Register 0x05 as well. A smaller subset of the independent feature list can be applied to those devices.

Register 0x04 Bits[3:0] must be set to the same value as Register 0x05 Bits[3:0]

Transfer (Register 0xFF)

All registers except Register 0x100 are updated the moment they are written. Setting Bit 0 of this transfer register high initializes the settings in the sample rate override register (Address 0x100).

Power Modes (Register 0x08)

Bits[7:6]—Open

Bit 5—External Power-Down Pin Function

If set, the external PDWN pin initiates standby mode. If cleared, the external PDWN pin initiates power-down mode.

Bits[4:2]—Open

Bits[1:0]—Power Mode

In normal operation (Bits[1:0] = 00), all ADC channels are active.

In power-down mode (Bits[1:0] = 01), the digital datapath clocks are disabled while the digital datapath is reset. Outputs are disabled.

In standby mode (Bits[1:0] = 10), the digital datapath clocks and the outputs are disabled.

During a digital reset (Bits[1:0] = 11), all the digital datapath clocks and the outputs (where applicable) on the chip are reset, except the SPI port. Note that the SPI is always left under control of the user; that is, it is never automatically disabled or in reset (except by power-on reset).

Clock (Register 0x09)

Bits[7:1]—Open

Bit 0—Duty Cycle Stabilize.

The default state is Bit 0 = 1, duty cycle stabilizer off.

Note that, when the part is not in SPI mode, the duty cycle stabilizer is on. Refer to the Configuration Without the SPI section for more information.

Enhancement Control (Register 0x0C)

Bits[7:3]—Open

Bit 2—Chop Mode

For applications that are sensitive to offset voltages and other low frequency noise, such as homodyne or direct conversion receivers, chopping in the first stage of the AD9653 is a feature that can be enabled by setting Bit 2. In the frequency domain, chopping translates offsets and other low frequency noise to $f_{CLK}/2$ where it can be filtered.

Bits[1:0]—Open

Output Mode (Register 0x14)

Bit 7—Open

Bit 6—LVDS-ANSI/LVDS-IEEE Option

Setting this bit chooses LVDS-IEEE (reduced range) option. The default setting is LVDS-ANSI. As described in Table 20, when LVDS-ANSI or LVDS-IEEE reduced range link is selected, the user can select the driver termination. The driver current is automatically selected to give the proper output swing.

Table 20. LVDS-ANSI/LVDS-IEEE Options

Output Mode, Bit 6	Output Mode	Output Driver Termination	Output Driver Current
0	LVDS-ANSI	User selectable	Automatically selected to give proper swing
1	LVDS-IEEE reduced range link	User selectable	Automatically selected to give proper swing

Bits[5:3]—Open

Bit 2—Output Invert

Setting this bit inverts the output bit stream.

Bit 1—1

Bit 0—Output Format

By default, this bit is set to send the data output in twos complement format. Resetting this bit changes the output mode to offset binary.

Output Adjust (Register 0x15)

Bits[7:6]—Open

Bits[5:4]—Output Driver Termination

These bits allow the user to select the internal termination resistor.

Bits[3:1]—Open

Bit 0—Output Drive

Bit 0 of the output adjust register controls the drive strength on the LVDS driver of the FCO and DCO outputs only. The default values set the drive to 1× while the drive can be increased to 2× by setting the appropriate channel bit in Register 0x05 and then setting Bit 0. These features cannot be used with the output driver termination select. The termination selection takes

precedence over the 2× driver strength on FCO and DCO when both the output driver termination and output drive are selected.

Output Phase (Register 0x16)

Bit 7—Open

Bits[6:4]—Input Clock Phase Adjust

When the clock divider (Register 0x0B) is used, the applied clock is at a higher frequency than the internal sampling clock. Register 0x16 Bits[6:4] determine at which phase of the external clock the sampling occurs. This is applicable only when the clock divider is used. It is prohibited to select a value for Bits[6:4] that is greater than the value of Bits[2:0], Register 0x0B.

Table 21. Input Clock Phase Adjust Options

Input Clock Phase Adjust, Bits[6:4]	Number of Input Clock Cycles of Phase Delay
000 (Default)	0
001	1
010	2
011	3
100	4
101	5
110	6
111	7

Bits[3:0]—Output Clock Phase Adjust

Table 22. Output Clock Phase Adjust Options

Output Clock (DCO), Phase Adjust, Bits[3:0]	DCO Phase Adjustment (Degrees Relative to D0±x/D1±x Edge)
0000	0
0001	60
0010	120
0011 (Default)	180
0100	240
0101	300
0110	360
0111	420
1000	480
1001	540
1010	600
1011	660

Table 23. SPI Register Options

Register 0x21 Contents	Serialization Options Selected			DCO Multiplier	Timing Diagram
	Serial Output Number of Bits (SONB)	Frame Mode	Serial Data Mode		
0x30	16-bit	1×	DDR two-lane, bitwise	$4 \times f_s$	Figure 2 (default setting)
0x20	16-bit	1×	DDR two-lane, bitwise	$4 \times f_s$	Figure 2
0x10	16-bit	1×	SDR two-lane, bitwise	$8 \times f_s$	Figure 2
0x00	16-bit	1×	SDR two-lane, bitwise	$8 \times f_s$	Figure 2
0x34	16-bit	2×	DDR two-lane, bitwise	$4 \times f_s$	Figure 3
0x24	16-bit	2×	DDR two-lane, bitwise	$4 \times f_s$	Figure 3
0x14	16-bit	2×	SDR two-lane, bitwise	$8 \times f_s$	Figure 3
0x04	16-bit	2×	SDR two-lane, bitwise	$8 \times f_s$	Figure 3
0x40	16-bit	1×	DDR one-lane, wordwise	$8 \times f_s$	Figure 4

Serial Output Data Control (Register 0x21)

The serial output data control register is used to program the AD9653 in various output data modes depending upon the data capture solution. Table 23 describes the various serialization options available in the AD9653.

Sample Rate Override (Register 0x100)

This register is designed to allow the user to downgrade the device (that is, establish lower power) for applications that do not require a full sample rate. Settings in this register are not initialized until Bit 0 of the transfer register (Register 0xFF) is set to 1.

This function does not affect the sample rate; it affects the maximum sample rate capability of the ADC, as well as the resolution.

User Input/Output Control 2 (Register 0x101)

Bits[7:1]—Open

Bit 0—SDIO Pull-Down

Bit 0 can be set to disable the internal 30 kΩ pull-down on the SDIO pin, which can be used to limit the loading when many devices are connected to the SPI bus.

User Input/Output Control 3 (Register 0x102)

Bits[7:4]—Open

Bit 3—VCM Power-Down

Bit 3 can be set high to power down the internal VCM generator. This feature is used when applying an external reference.

Bits[2:0]—Open

APPLICATIONS INFORMATION

DESIGN GUIDELINES

Before starting design and layout of the AD9653 as a system, it is recommended that the designer become familiar with these guidelines, which describes the special circuit connections and layout requirements that are needed for certain pins.

POWER AND GROUND RECOMMENDATIONS

When connecting power to the AD9653, it is recommended that two separate 1.8 V supplies be used. Use one supply for analog (AVDD); use a separate supply for the digital outputs (DRVDD). For both AVDD and DRVDD, several different decoupling capacitors should be used to cover both high and low frequencies. Place these capacitors close to the point of entry at the PCB level and close to the pins of the part, with minimal trace length.

A single PCB ground plane should be sufficient when using the AD9653. With proper decoupling and smart partitioning of the PCB analog, digital, and clock sections, optimum performance is easily achieved.

CLOCK STABILITY CONSIDERATIONS

When powered on, the AD9653 enters an initialization phase during which an internal state machine sets up the biases and the registers for proper operation. During the initialization process, the AD9653 needs a stable clock. If the ADC clock source is not present or not stable during ADC power-up, it disrupts the state machine and causes the ADC to start up in an unknown state. To correct this, an initialization sequence must be reinvoked after the ADC clock is stable by issuing a digital reset via Register 0x08. In the default configuration (internal V_{REF} , ac-coupled input) where V_{REF} and V_{CM} are supplied by the ADC itself, a stable clock during power-up is sufficient. In the case where V_{REF} and/or V_{CM} are supplied by an external source, these, too, must be stable at power-up; otherwise, a subsequent digital reset via Register 0x08 is needed. The pseudo code sequence for a digital reset is as follows:

```
SPI_Write (0x08, 0x03);   Digital Reset
SPI_Write (0x08, 0x00);   Can be asserted as
                           soon as the next
                           SPI instruction,
                           normal operation
                           resumes after 2.9
                           million sample
                           clock cycles, ADC
                           outputs 0s until
                           the reset is
                           complete.
```

EXPOSED PAD THERMAL HEAT SLUG RECOMMENDATIONS

It is required that the exposed pad on the underside of the ADC be connected to analog ground (AGND) to achieve the best electrical and thermal performance of the AD9653. An exposed continuous copper plane on the PCB should mate to the AD9653 exposed pad, Pin 0. The copper plane should have several vias to achieve the lowest possible resistive thermal path for heat dissipation to flow through the bottom of the PCB. These vias should be solder-filled or plugged.

To maximize the coverage and adhesion between the ADC and PCB, partition the continuous copper plane by overlaying a silkscreen on the PCB into several uniform sections. This provides several tie points between the ADC and PCB during the reflow process, whereas using one continuous plane with no partitions only guarantees one tie point. See Figure 76 for a PCB layout example. For detailed information on packaging and the PCB layout of chip scale packages, see the AN-772 Application Note, *A Design and Manufacturing Guide for the Lead Frame Chip Scale Package (LFCSP)*, at www.analog.com.

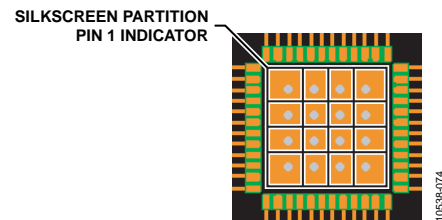

Figure 76. Typical PCB Layout

VCM

The VCM pin should be bypassed to ground with a 0.1 μF capacitor.

REFERENCE DECOUPLING

The VREF pin should be externally bypassed to ground with a low ESR, 1.0 μF capacitor in parallel with a low ESR, 0.1 μF ceramic capacitor.

SPI PORT

The SPI port should not be active during periods when the full dynamic performance of the converter is required. Because the SCLK, CSB, and SDIO signals are typically asynchronous to the ADC clock, noise from these signals can degrade converter performance. If the on-board SPI bus is used for other devices, it may be necessary to provide buffers between this bus and the AD9653 to keep these signals from transitioning at the converter inputs during critical sampling periods.

CROSSTALK PERFORMANCE

The AD9653 is available in a 48-lead LFCSP with the input pairs on either corner of the chip. See Figure 6 for the pin configuration. To maximize the crosstalk performance on the board, add grounded filled vias in between the adjacent channels as shown in Figure 77.

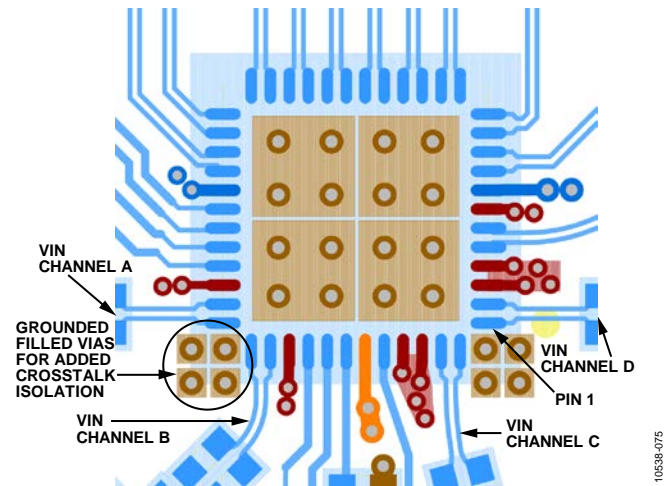
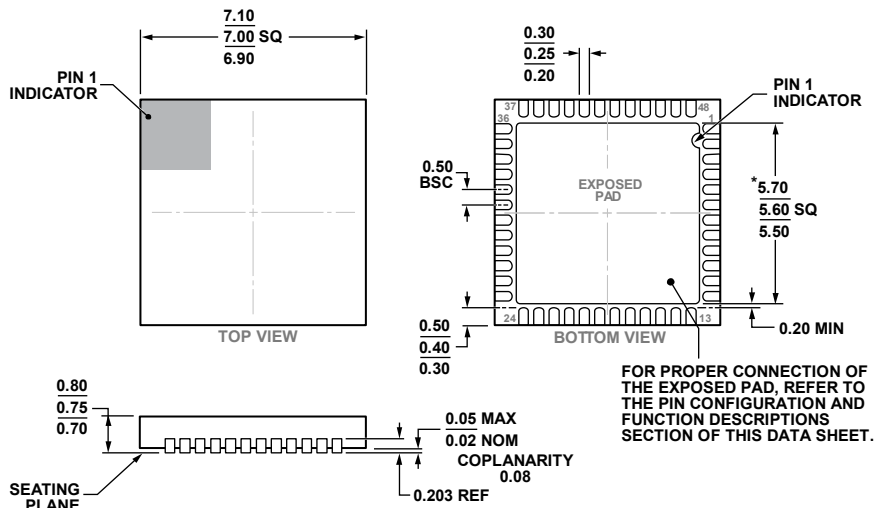

Figure 77. Layout Technique to Maximize Crosstalk Performance

10638-075

OUTLINE DIMENSIONS



*COMPLIANT TO JEDEC STANDARDS MO-220-WKKD-2 WITH THE EXCEPTION OF THE EXPOSED PAD DIMENSION.

Figure 78. 48-Lead Lead Frame Chip Scale Package [LFCSP_WQ]
 7 mm × 7 mm Body, Very Very Thin Quad
 (CP-48-13)
 Dimensions shown in millimeters

10-24-2013-D

ORDERING GUIDE

Model ¹	Temperature Range	Package Description	Package Option
AD9653BCPZ-125	-40°C to +85°C	48-Lead Lead Frame Chip Scale Package [LFCSP_WQ]	CP-48-13
AD9653BCPZRL7-125	-40°C to +85°C	48-Lead Lead Frame Chip Scale Package [LFCSP_WQ]	CP-48-13
AD9653-125EBZ		Evaluation Board	

¹ Z = RoHS Compliant Part.