



Biscuit DC (DC Blower)

COMAIR ROTRON PART NUMBER: **032176**
 COMAIR ROTRON MODEL NUMBER: **BD12A3**



MOTOR	
Rated Voltage:	12
Operating Voltage Range:	6 - 14
Running Current: (amps)	0.9
Locked Rotor Current: (amps)	1.9
Rated Power: (watts)	10.8
Nominal Speed: (rpm)	3040

MECHANICAL	
Dimensions:	120.7mm x 31.0mm (4.75in x 1.22in)
Bearing Type:	Sleeve
Motor Base:	Lexan 500, Black, UL94V-0
Propeller:	Polypropylene, Black, UL94V-0

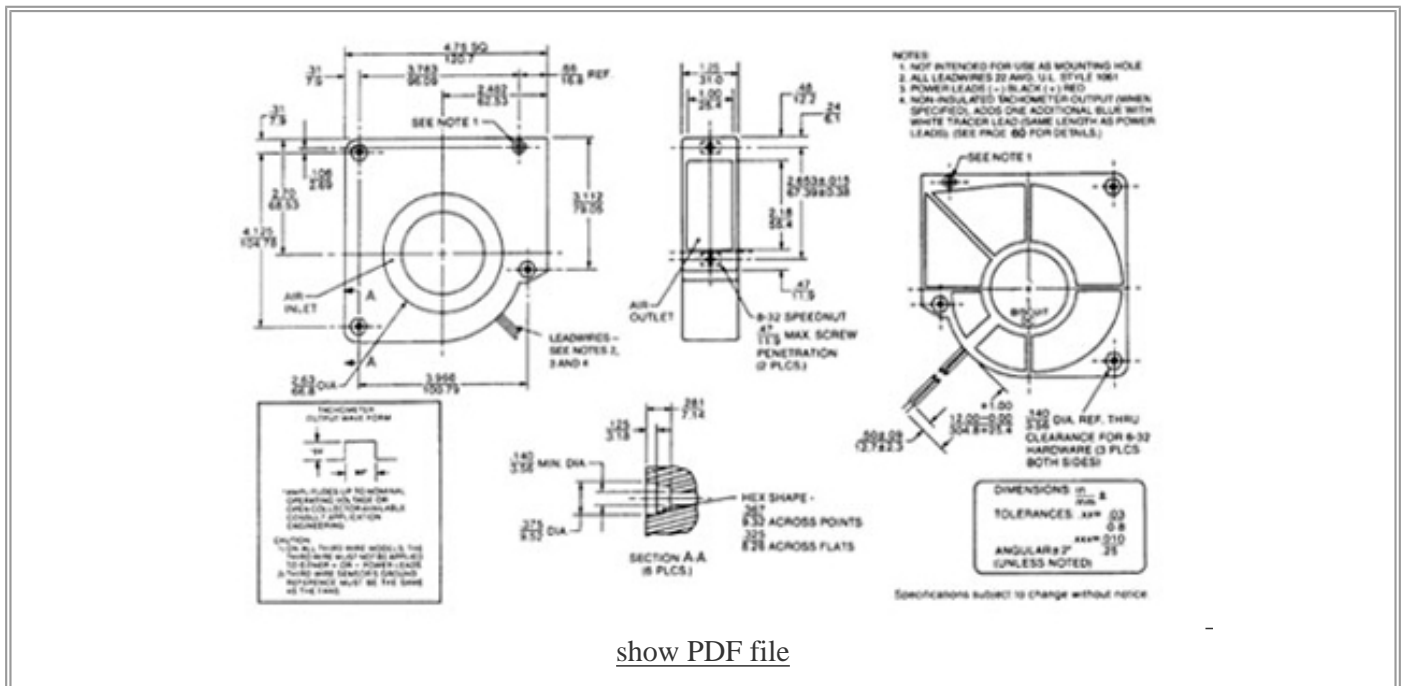

[show PDF file](#)

NOTES

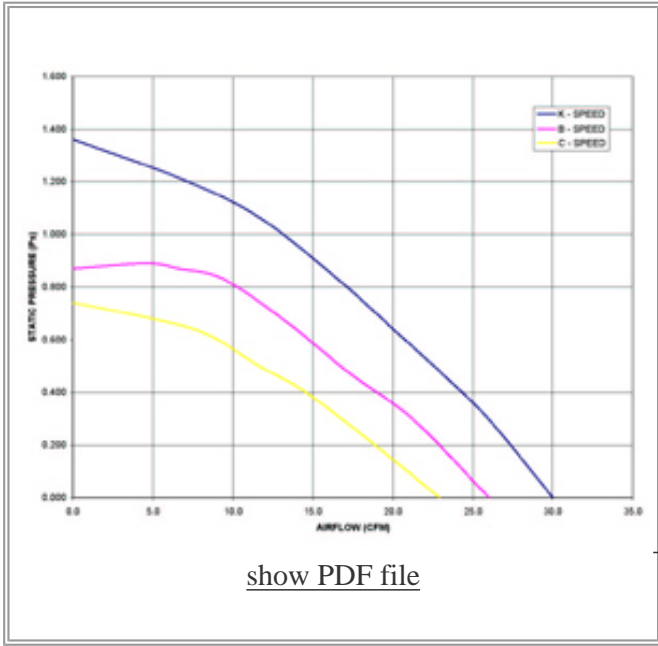

PERFORMANCE CHARACTERISTICS	
Air Flow: (CFM)	26
Static Pressure:	.870

TERMINATION	
Leadwires:	12" Leadwires

SAFETY	

All product names are used under license and are trademarks or registered trademarks of Comair Rotron, Inc.

[New Search](#)