

Product Data Sheet RER190-39/14/2TDMO

ebmpapst

Die Wahl der Ingenieure



RER190-39/14/2TDMO

INDEX

1	General	3
2	Mechanics	3
2.1	General	3
2.2	Connections	3
3	Operating Data	4
3.1	Operating Data - Electrical Interface - Input	4
3.2	Electrical Operating Data	7
3.3	Operating Data - Electrical Interface -Output	8
3.4	Electrical Features	9
3.5	Data according ErP directive	9
3.6	Aerodynamic	10
4	Environment	11
4.1	General	11
4.2	Climatic requirements*).....	11
5	Safety	12
5.1	Electrical Safety	12
5.2	Approval Tests	12
6	Reliability	12
6.1	General	12

1 General

Fan type	Blower without chassis with intake nozzle	
Rotational direction looking at rotor	clockwise	
Airflow direction	Air in axially, Air out radially	
Bearing system	Ball bearing	
Mounting position	any	

2 Mechanics

2.1 General

Depth	68,5 mm	
Diameter	190 mm	
Weight	0,870 kg	
Housing material		
Impeller material	Plastic	

2.2 Connections

Electrical connection	Wires	
Length of lead wire	L = 425 mm	
Tolerance	+/- 10,0 mm	
Length of tube	S = 115 mm	
Tolerance	+/- 5 mm	
Wire gauge (AWG)	18	
Insulation diameter	2,05 mm	

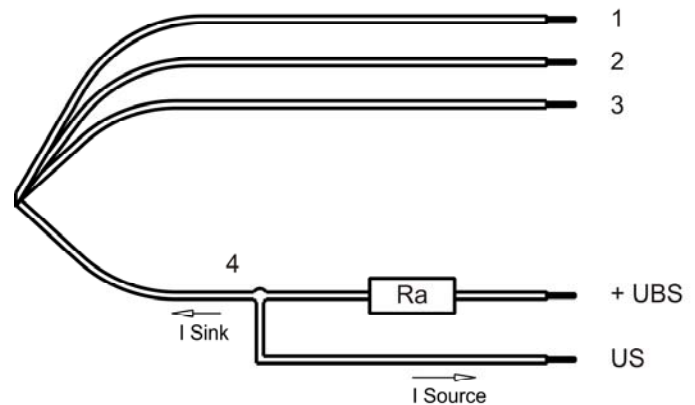

	Colour	Operation
Wire 1	red	+ UB
Wire 2	blue	- GND
Wire 3	violet	CONTR
Wire 4	white	Tacho

The auxiliaries shown on the schematic diagram (which are required for the intended use) are not part of our delivery.

Lead wire 1 - 2: AWG18

Lead wire 3 - 4: AWG22 (Insulation diameter 1,35mm)

3 Operating Data

3.1 Operating Data - Electrical Interface - Input

Control input	Analog
---------------	--------

Features

PWM - Frequency	1 kHz - 10 kHz Typical: 2 kHz
Input voltage range	0 V - 10 V

Characteristics

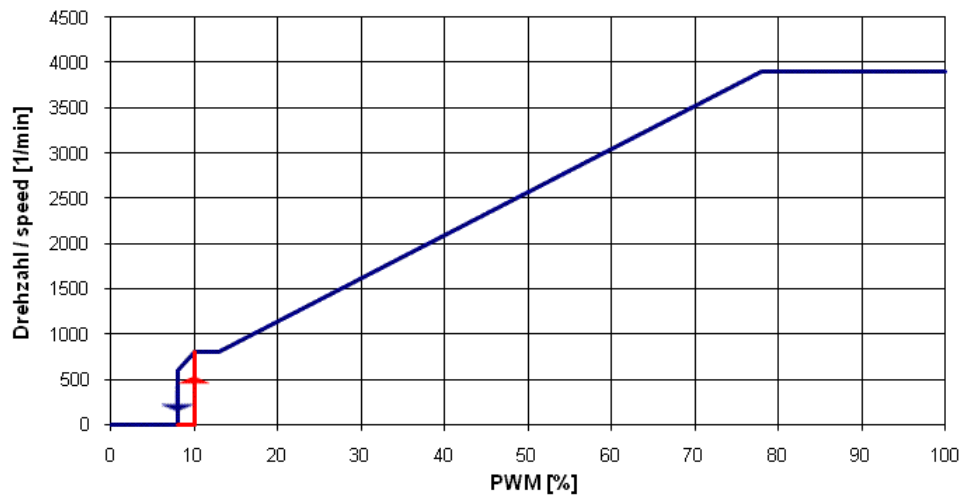
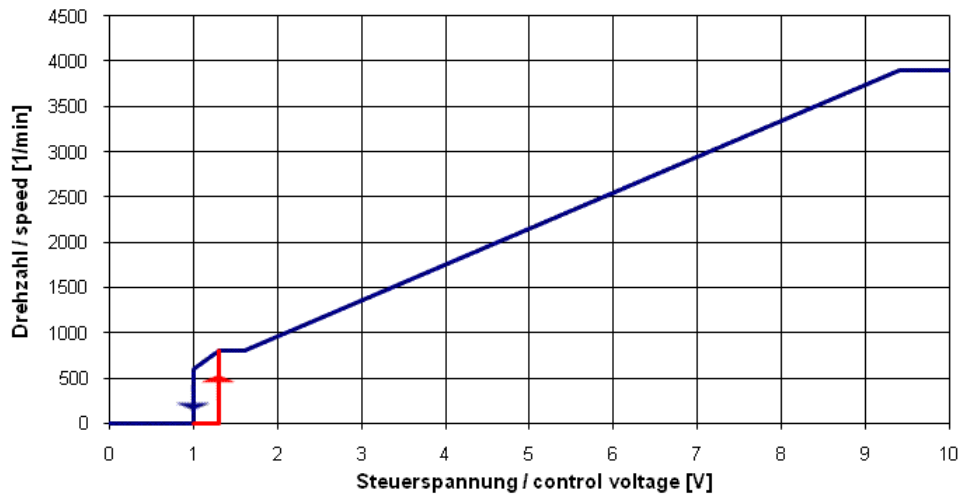

Schematics

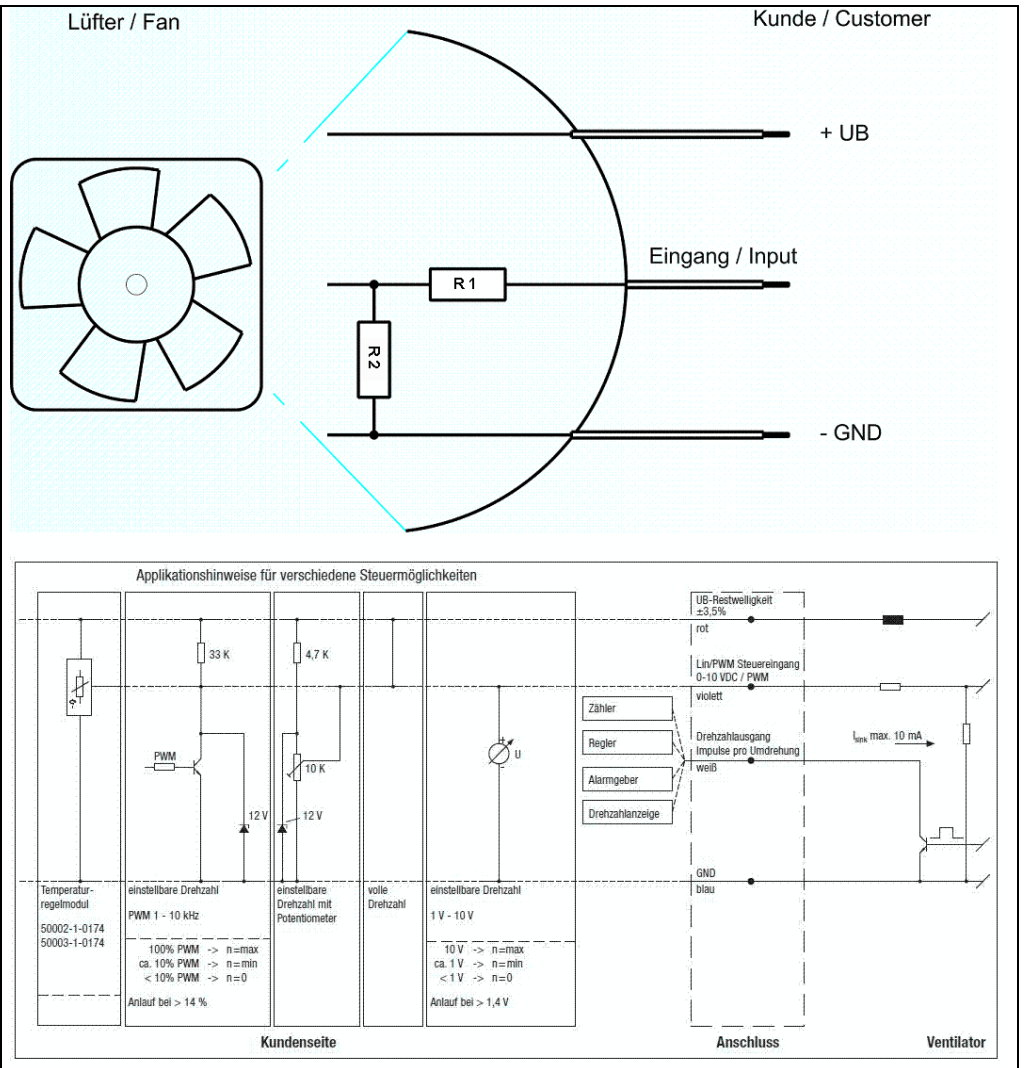

Input voltage divider:

R1 = 47 kOhm

R2 = 36 kOhm

For protection: There is parallel to R2 a 5,1 V Z-Diode

Speed control:

By pulse-width modulation (PWM) 0 ... 100%
 with switching transistor in emitter circuit and collector resistance to 12 V
 Frequency = 2 kHz (1 - 10 kHz)

Information to the curve PWM:

- 0% - <10% PWM: 0 1/min
- 10% PWM: 800 1/min (Fan on, coming from 0% PWM)
- 10% - 13% PWM: 800 1/min (corresponding to min. speed)
- 13% - 78% PWM: linear increasing curve
- 78% - 100% PWM: 3.900 1/min (corresponding to max. speed)
- 10% - >8% PWM: linear decreasing curve (coming from 100% PWM)
- 8% PWM: 600 1/min or 0 1/min (Fan off, coming from 100% PWM)

or:

Speed control:

By analog voltage 0 - 10 V

Information to the curve analog:

0 V - < 1,3 V:

1,3 V:

1,3 V - 1,6 V:

1,6 V - 9,4 V:

9,4 V - 10 V:

1,3 V - > 1,0 V:

1,0 V:

0 1/min

800 1/min (Fan on, coming from 0 V)

800 1/min (corresponding to min. speed)

linear increasing curve

3.900 1/min (corresponding to max. speed)

linear decreasing curve (coming from 10 V)

600 1/min or 0 1/min (Fan off, coming from 10 V)

The fan have no sensor break detection!

3.2 Electrical Operating Data

Measurement conditions: Normal air density = 1,2 kg/m³; Temperature 23°C +/- 3°C; Motor axis horizontal; warm-up time before measuring 5 minutes (unless otherwise specified).
In the intake and outlet area should not be any solid obstruction within 0,5 m.

Measurement setup:	Measured between two steel plates
Steel plate:	195 mm x 195 mm
Intake nozzle:	D: 125,5 mm; R: 10 mm
Distance between bottom and top plate:	80 mm
Overlapping impeller / nozzle:	2 mm

$\Delta p = 0$: corresp. to free air flow (see section 3.5)
I: corresp. to arithm. mean current value

Name	Condition
U Contr. 0001	U Contr.: 10,0 V

Features	Condition	Symbol	Values		
Voltage range	$\Delta p = 0$	U	16,0 V		36,0 V
Nominal voltage	$\Delta p = 0$	U_N		24,0 V	
Power consumption	$\Delta p = 0$	P	50,5 W	104,0 W	115,2 W
Tolerance	U Contr. 0001		+/- 10,0 %	+/- 10,0 %	+/- 10,0 %
Current consumption	$\Delta p = 0$	I	3.200 mA	4.880 mA	3.200 mA
Tolerance	U Contr.0001		+/- 10,0 %	+/- 10,0 %	+/- 10,0 %
Speed	$\Delta p = 0$	n	3.060 1/min	3.900 1/min	3.900 1/min
Tolerance	U Contr. 0001		+/- 10,0 %	+/- 5,0 %	+/- 5,0 %
max. allowed input voltage ripple (within the specified voltage range)			+/- 3 %		
max. allowed input voltage ripple (within the specified voltage range)			>= 50 Hz		

100% PWM; f = 2 kHz or broken lead wire (open control input)

Name	Condition
U Contr. 0002	U Contr.: 5,0 V

Features	Condition	Symbol	Values		
Voltage range	$\Delta p = 0$	U	16,0 V		36,0 V
Nominal voltage	$\Delta p = 0$	U_N		24,0 V	
Power consumption	$\Delta p = 0$	P	22,2 W	24,0 W	25,9 W
Tolerance	U Contr. 0002		+/- 10,0 %	+/- 10,0 %	+/- 10,0 %
Current consumption	$\Delta p = 0$	I	1.400 mA	1.000 mA	720 mA
Tolerance	U Contr. 0002		+/- 10,0 %	+/- 10,0 %	+/- 10,0 %
Speed	$\Delta p = 0$	n	2.300 1/min	2.300 1/min	2.300 1/min
Tolerance	U Contr. 0002		+/- 5,0 %	+/- 5,0 %	+/- 5,0 %

3.3 Operating Data - Electrical Interface -Output

Tacho type	/2 (Open collector)
------------	---------------------

Signal-Ausgangsspannung / Signal output voltage

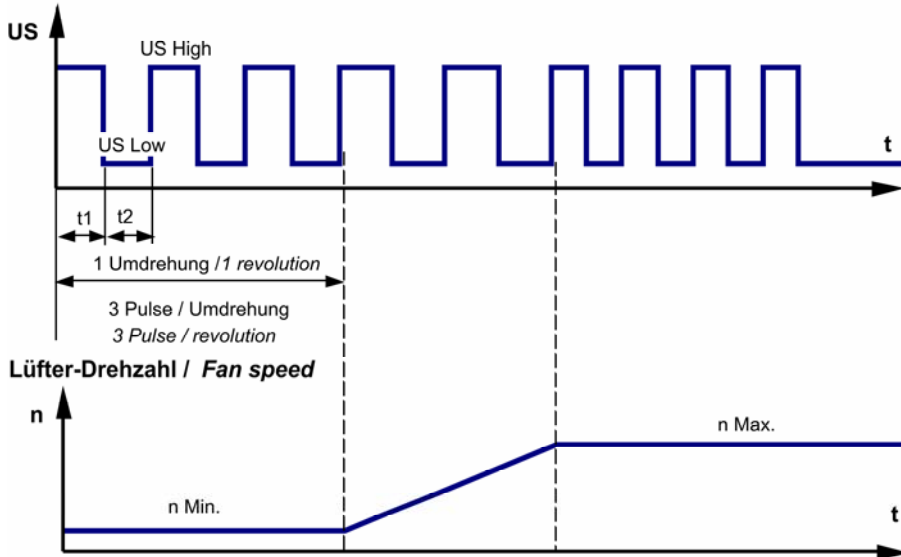

$$R_a = \frac{U_{BS} - US_{Low}}{I_{Sink}}$$

Features	Note	Values
Tacho operating voltage (UBS)		<= 60,0 V
Tacho signal Low	I sink: 2 mA	<= 0,4 V
Tacho signal High	I source: 0 mA	<= 60,0 V
Maximum sink current		<= 20 mA
External resistor	External resistor Ra from UBS to US required. All voltages measured to GND.	
Tacho frequency	(3 x n) / 60	195 Hz
Tacho isolated from motor	No	
Slew rate		=> 0,5 V/us

Please note:

At zero speed the tacho signal is at a static HIGH. It will be also HIGH when the fan is still spinning, but the speed control signal is set to zero speed already.

The tacho signal is only activated after the start-up is completed.

Alarm type	None
------------	------

3.4 Electrical Features

Electronic function	Speed-Controlled	
Reversed polarity protection	P-CH FET	
Max. residual current at Un	IF ≤ 5 mA	
Locked rotor protection	Auto restart	
Locked rotor current at Un	approx. 3.950 mA	
Clock signal t3/t4 at locked rotor	Typical: 3,6 s / 10,0 s	

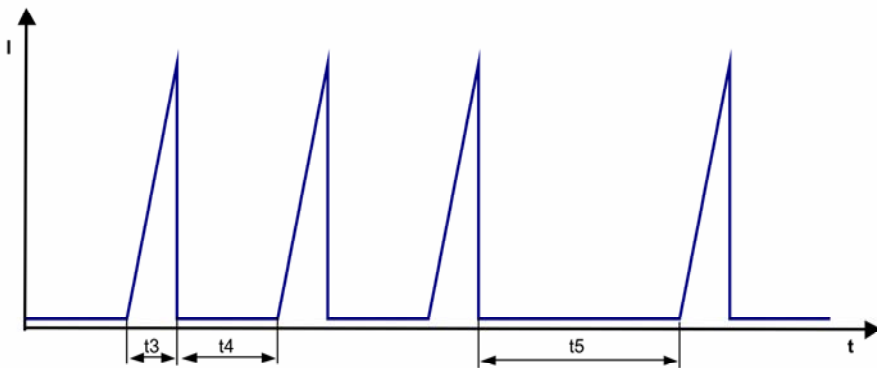

Locked rotor signal t5:

After 4 failed start-ups there is an extended timeout of 40 s.

3.5 Data according ErP directive

Installation / Efficiency category	A / static
Speed control	integrated
Specific ratio	1,00482
Target overall efficiency 2015	42,4 %
Overall efficiency	56,2 %
Efficiency grade	62
Power input	135,7 W
Speed	3.900 1/min

All values measured in optimum energy efficiency point.

Productiondatecode is printed on the fan label.

3.6 Aerodynamic

Measurement conditions: Measured with a double chamber intake rig acc. to DIN EN ISO 5801.
 Normal air density = 1,2 kg/m³; Temperature 23°C +/- 3°C;
 In the intake and outlet area should not be any solid obstruction within 0,5 m.
 The information is only valid under the specified test conditions and may be changed by the installation conditions. If there are deviations from the standard test conditions, the characteristic values must be checked under the installed conditions.

Measurement setup:	Measured between two steel plates
Steel plate:	195 mm x 195 mm
Intake nozzle:	D: 125,5 mm; R: 10 mm
Distance between bottom and top plate:	80 mm
Overlapping impeller / nozzle:	2 mm

a.) Operation condition:

3.900 1/min at free air flow	U Contr. 10,0 V		
------------------------------	-----------------	--	--

Max. free-air flow ($\Delta p = 0 / \dot{V} = \text{max.}$)	860,0 m ³ /h	
Max. static pressure ($\Delta p = \text{max.} / \dot{V} = 0$)	730 Pa	

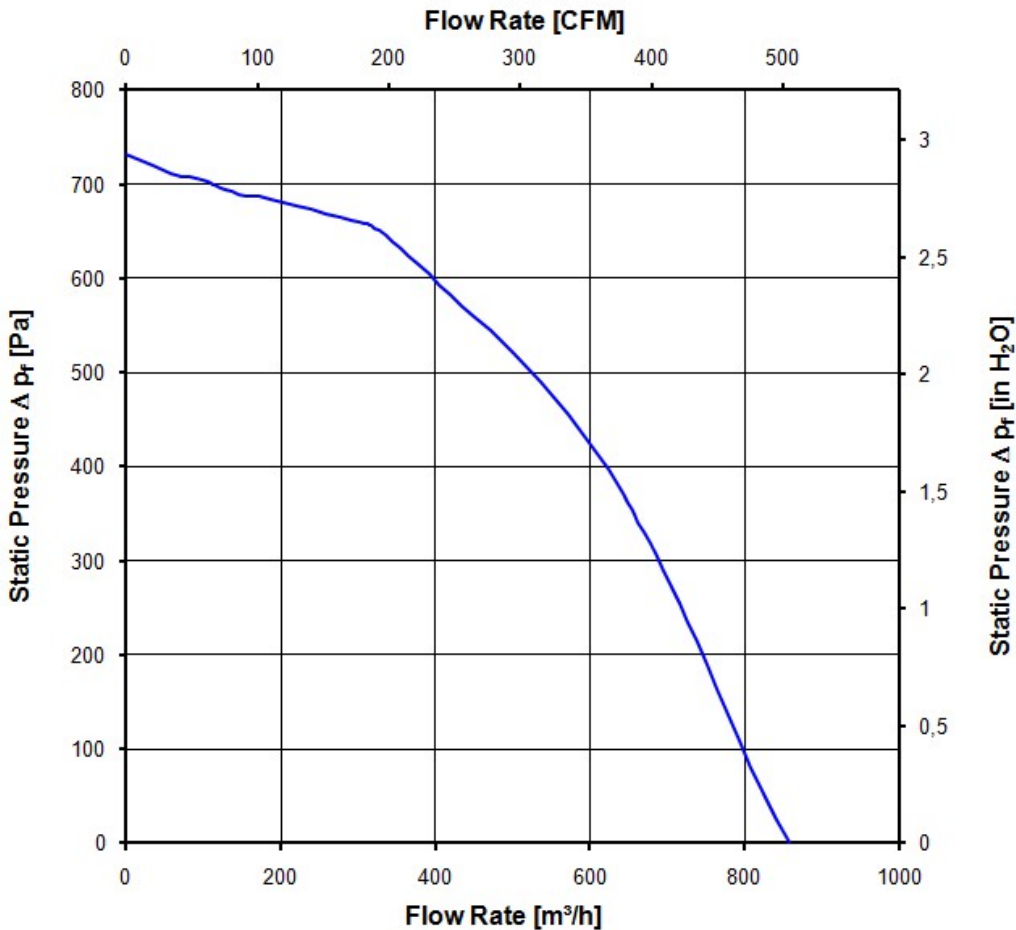

4 Environment

4.1 General

Min. permitted ambient temperature TU min.	-20 °C	
Max. permitted ambient temperature TU max.	65 °C	
Min. permitted storage temperature TL min.	-40 °C	
Max. permitted storage temperature TL max.	80 °C	

4.2 Climatic requirements*)

Humidity requirements	humid heat, constant; according to DIN EN 60068-2-78, 14 days	
Water exposure	None	
Dust requirements	None	
Salt fog requirements	None	

*) Permitted application area:

The product is intended for use in sheltered rooms with controlled temperature and controlled humidity. Directly exposure to water must be avoided.

Pollution degree 1 (according DIN EN 60664-1)

There is either no pollution or it occurs only dry, non-conductive pollution. The pollution has no negative impact.

5 Safety

5.1 Electrical Safety

Dielectric strength DIN EN 60950 (VDE 0805) and DIN EN 60335 (VDE 0700) A.) Type test Measuring conditions: After 48h of storage at 95% R.H. and 25°C. No arcing or breakdown is allowed! All connections together to ground. B.) Routine test Measuring conditions: At indoor climate. No arcing or breakdown is allowed! All connections together to ground.	500 VAC / 1 Min. 500 VAC / 1 Sec.	
Isolation resistance Measuring conditions: After 48h of storage at 95% R.H. and 25°C measured with U=500 VDC for 1 min.	RI > 10 MOhm	
clearance / creepage distance	1,0 mm / 1,2 mm	
Protection class	III	

5.2 Approval Tests

CE	EC Declaration of Conformity	No
EAC	Eurasian Conformity	Yes
UL	Underwriters Laboratories	Yes / UL507, Electric Fans
VDE	Association for Electrical, Electronic and Information Technologies	Yes / Approval acc. to EN 60950 (VDE 0805) - Information technology equipment
CSA	Canadian Standards Association	Yes / C22.2 No. 113 Fans and Ventilators
CCC	China Compulsory Certification	No

6 Reliability

6.1 General

Life expectancy L10 at TU = 40 °C	52.500 h	
Life expectancy L10 at TU max.	30.000 h	
Life expectancy L10 Delta (40 °C)	105.000 h	

Drawing of this technical solution is subject to the responsibility of the customer. The manufacturer is not responsible for any damage or injury caused by the use of this technical solution.

Zeichnung nach DIN 204 (ISO 10131) basierend auf der Produktspezifikation.

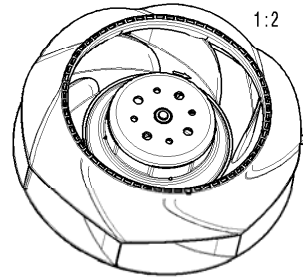
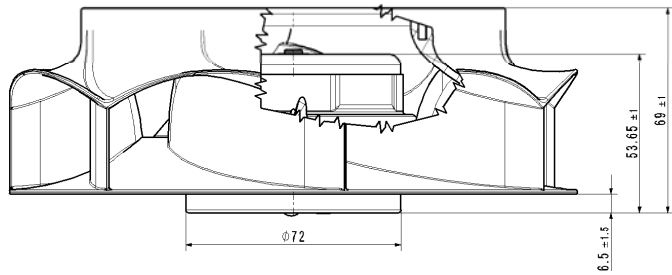
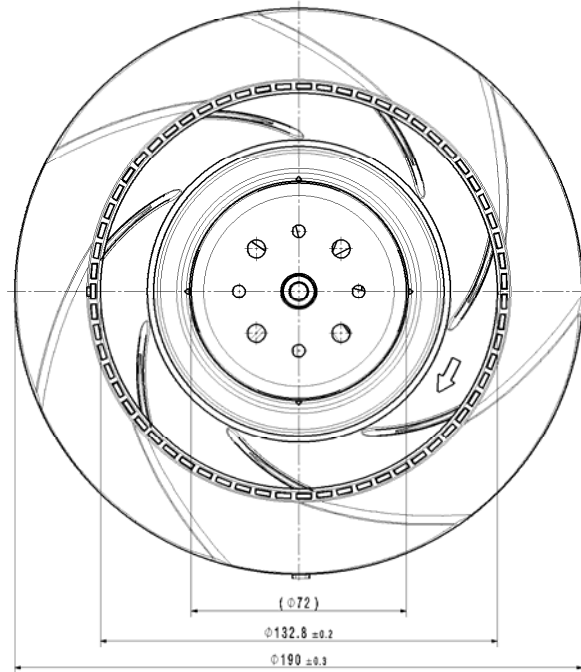
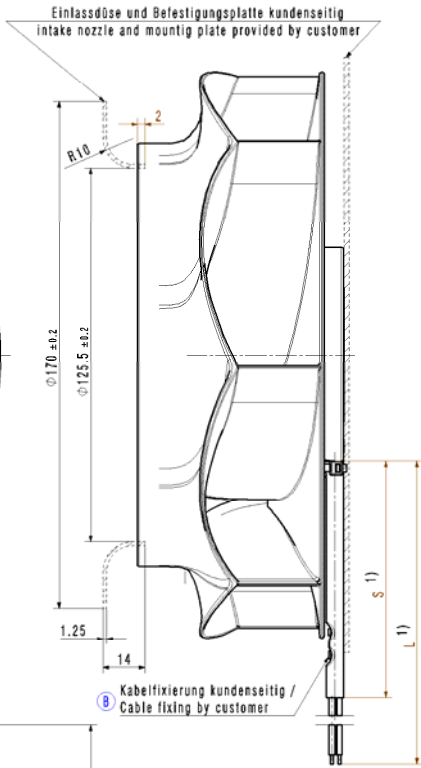
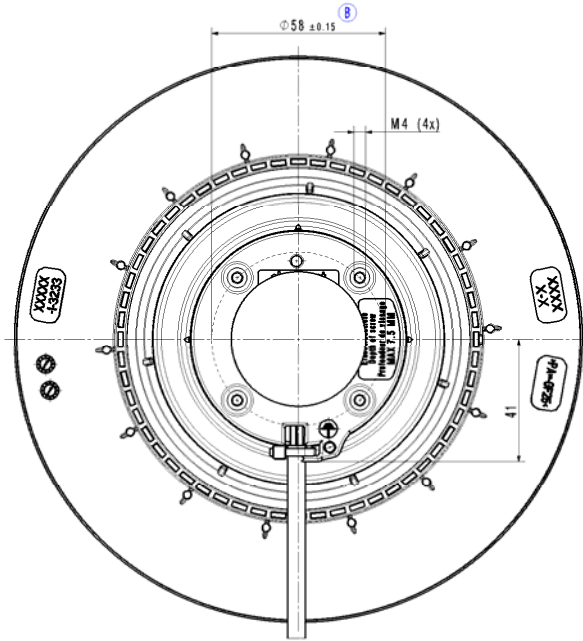

1:2

1.) Anzahl und Länge der Litzen sowie Länge des Schlauches ab Flanschrand siehe Produktspezifikation
 --- Axialspiel der Kugellager mit Feder spielfrei verspannt.

1.) Length and number of wires and length of tube from flange edge see design specification.
 --- without axial clearance by a pre-loaded spring.

500-Modulcode 	Serie, Nr. / Change No.	5000-Systemfunktion 5000-Systemfunktion	500-Systemcode 500-Systemcode	Werkstoff / Material: 5000-Systemcode	Volumen / Volume (cm³):
5000-Systemcode				Gewicht / Mass (g):	
Toleranzung / Tolerances: 	Drehmoment / Torque (Nm)	Drehmoment / Torque (Nm)	Drehmoment / Torque (Nm)	Drehmoment / Torque (Nm)	Drehmoment / Torque (Nm)
Allg. Eigenschaften / Gen. Characteristics:	Drehmoment / Torque (Nm)	Drehmoment / Torque (Nm)	Drehmoment / Torque (Nm)	Drehmoment / Torque (Nm)	Drehmoment / Torque (Nm)
ebmpapst ebmpapst AG, Georgen, 8000 S. 60 00			Drehmoment / Torque (Nm)	Drehmoment / Torque (Nm)	Drehmoment / Torque (Nm)