

# Safety relays - PSR-MC34-3NO-1DO-24DC-SP - 2700548

Please be informed that the data shown in this PDF Document is generated from our Online Catalog. Please find the complete data in the user's documentation. Our General Terms of Use for Downloads are valid (<http://phoenixcontact.com/download>)



Safety relay for emergency stop and safety doors up to SILCL 3, Cat. 4, PL e, 2-channel operation, automatic or manual, monitored start, cross-circuit detection, 3 enabling current paths,  $U_s = 24\text{ V DC}$ , plug-in spring-cage terminal block

The figure shows a version with a screw connection

## Why buy this product

- Up to Cat.4/PL e according to ISO 13849-1, SILCL 3 according to IEC 62061
- Low housing width of just 12.5 mm
- Two-channel control
- 3 enabling current paths, 1 digital signal output
- Manually monitored and automatic activation in a single device
- Cross-circuit detection



## Key Commercial Data

Packing unit	1 pc
GTIN	 4 046356 912686
Weight per Piece (excluding packing)	173.7 g
Custom tariff number	85371099
Country of origin	Germany

## Technical data

### Note

Utilization restriction	EMC: class A product, see manufacturer's declaration in the download area
-------------------------	---

### Dimensions

Width	12.5 mm
Height	116.6 mm
Depth	114.5 mm

# Safety relays - PSR-MC34-3NO-1DO-24DC-SP - 2700548

## Technical data

### Ambient conditions

Ambient temperature (operation)	-40 °C ... 55 °C (observe derating)
Ambient temperature (storage/transport)	-40 °C ... 85 °C
Max. permissible relative humidity (operation)	75 % (on average, 85% infrequently, non-condensing)
Max. permissible humidity (storage/transport)	75 % (on average, 85% infrequently, non-condensing)
Shock	15g
Vibration (operation)	10 Hz ... 150 Hz, 2g
Maximum altitude	≤ 2000 m (Above sea level)

### Input data

Rated control circuit supply voltage $U_s$	24 V DC -15 % / +10 %
Power consumption at $U_s$	typ. 2 W
Rated control supply current $I_s$	typ. 84 mA
Typical inrush current	5 A ( $\Delta t = 200 \mu s$ at $U_s$ )
Current consumption	< 5 mA (with $U_s/I_x$ to S12)
	< 5 mA (with $U_s/I_x$ to S22)
	> -5 mA (with $U_s/I_x$ to S22/0V)
	> -5 mA (with $U_s/I_x$ to S34)
	< 10 mA (with $U_s/I_x$ to S34)
Voltage at input/start and feedback circuit	24 V DC -15 % / +10 %
Typical response time	< 175 ms (automatic start)
	< 175 ms (manual, monitored start)
Typical pick-up time	< 250 ms (when controlled via A1)
Typical release time	< 20 ms (when controlled via A1 or S12 and S22.)
Recovery time	< 500 ms
Status display	3 x green LED
Maximum switching frequency	0.5 Hz
Max. permissible overall conductor resistance	150 $\Omega$
Filter time	1 ms (at A1 in the event of voltage dips at $U_s$ )
	max. 1.5 ms (at S12, S22; test pulse width)
	min. 7.5 ms (at S12, S22; test pulse rate)
	Test pulse rate = 5 x Test pulse width

### Output data

Contact type	3 enabling current paths
Contact material	AgSnO <sub>2</sub>
Minimum switching voltage	20 V AC/DC
Maximum switching voltage	250 V AC/DC
Limiting continuous current	6 A (N/O contact; as the 23/24/34 contact path only occupies one input path, only a total current of 6 A is permitted here )
Inrush current, minimum	3 mA
Maximum inrush current	6 A

# Safety relays - PSR-MC34-3NO-1DO-24DC-SP - 2700548

## Technical data

### Output data

Sq. Total current	72 A <sup>2</sup> (see to derating)
Switching capacity	min. 60 mW
Output fuse	6 A gL/gG (N/O contact)
	4 A gL/gG (for low-demand applications)

### Alarm outputs

Number of outputs	1 (digital, PNP)
Voltage	22 V DC (U <sub>s</sub> - 2 V)
Current	max. 100 mA
Maximum inrush current	500 mA (Δt = 1 ms at U <sub>s</sub> )
Short-circuit protection	no

### General

Relay type	Electromechanical relay with forcibly guided contacts in accordance with IEC/EN 61810-3 (EN 50205)
Mechanical service life	10 x 10 <sup>6</sup> cycles
Net weight	173.7 g
Mounting type	DIN rail mounting
Assembly instructions	See derating curve
Degree of protection	IP20
Min. degree of protection of inst. location	IP54
Mounting position	vertical or horizontal
Control	Two-channel
Parameters as per EN ISO 13849	4
Stop category	0
Parameters for IEC 61508	3
Housing material	PBT

### Connection data

Connection method	Spring-cage connection
pluggable	Yes
Conductor cross section solid min.	0.2 mm <sup>2</sup>
Conductor cross section solid max.	1.5 mm <sup>2</sup>
Conductor cross section flexible min.	0.2 mm <sup>2</sup>
Conductor cross section flexible max.	1.5 mm <sup>2</sup>
Conductor cross section AWG min.	24
Conductor cross section AWG max.	16
Stripping length	8 mm

### Standards and Regulations

Shock	15g
Designation	Air clearances and creepage distances between the power circuits
Standards/regulations	DIN EN 50178

# Safety relays - PSR-MC34-3NO-1DO-24DC-SP - 2700548

## Technical data

### Standards and Regulations

Rated insulation voltage	250 V AC
Rated surge voltage/insulation	Basic insulation 4 kV: Between input circuit and enabling current path (23/24/34) Between all current paths and housing Safe isolation, reinforced insulation 6 kV: Between input circuit and enabling current path (13/14) Between enabling current path (13/14) and enabling current path (23/24/34)
Pollution degree	2
Overvoltage category	III
Safety Integrity Level Claim Limit (SIL CL)	3
Vibration (operation)	10 Hz ...150 Hz, 2g

## Classifications

### eCl@ss

eCl@ss 5.1	27371901
eCl@ss 6.0	27371819
eCl@ss 8.0	27371819

### ETIM

ETIM 5.0	EC001449
----------	----------

## Approvals

### Approvals

#### Approvals

UL Listed / cUL Listed / EAC / Functional Safety / cULus Listed

#### Ex Approvals

#### Approvals submitted

### Approval details

UL Listed 
---

# Safety relays - PSR-MC34-3NO-1DO-24DC-SP - 2700548

## Approvals

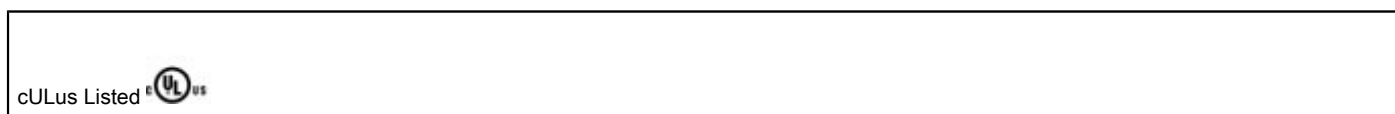
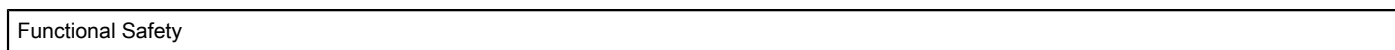
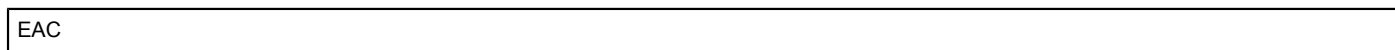
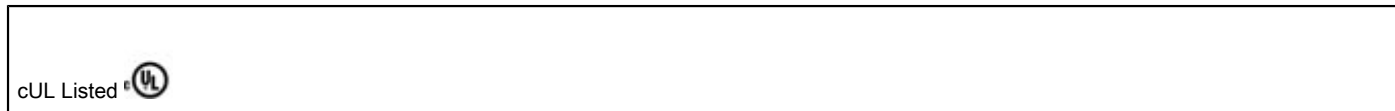

## Drawings

Block diagram

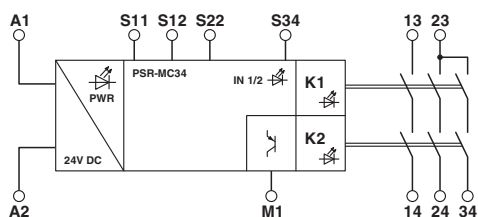

Block diagram

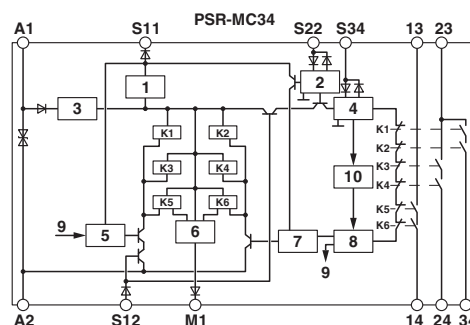

- Key:
- 1 = Current limitation
  - 2 = Input circuit
  - 3 = Voltage limitation
  - 4 = Start circuit
  - 5 = Control circuit channel 1
  - 6 = Control circuit signal output
  - 7 = Control circuit channel 2
  - 8 = Start channel 1 and 2
  - 9 = Channel 1
  - 10 = Diagnostics
  - K1, K2 ... K6 = Force-guided elementary relays

# Safety relays - PSR-MC34-3NO-1DO-24DC-SP - 2700548

Circuit diagram

