

FAN7382

High- and Low-Side Gate Driver



Features

- Floating Channels Designed for Bootstrap Operation to +600V
- Typically 350mA/650mA Sourcing/Sinking Current Driving Capability for Both Channels
- Common-Mode dv/dt Noise Canceling Circuit
- Extended Allowable Negative V_S Swing to -9.8V for Signal Propagation at $V_{CC}=V_{BS}=15V$
- V_{CC} & V_{BS} Supply Range from 10V to 20V
- UVLO Functions for Both Channels
- TTL Compatible Input Logic Threshold Levels
- Matched Propagation Delay Below 50nsec
- Output In-phase with Input Signal

Applications

- PDP Scan Driver
- Fluorescent Lamp Ballast
- SMPS
- Motor Driver

Description

The FAN7382, a monolithic high and low side gate-drive IC, can drive MOSFETs and IGBTs that operate up to +600V. Fairchild's high-voltage process and common-mode noise canceling technique provides stable operation of the high-side driver under high-dv/dt noise circumstances. An advanced level-shift circuit allows high-side gate driver operation up to $V_S=-9.8V$ (typical) for $V_{BS}=15V$. The input logic level is compatible with standard TTL-series logic gates. UVLO circuits for both channels prevent malfunction when V_{CC} or V_{BS} is lower than the specified threshold voltage. Output drivers typically source/sink 350mA/650mA, respectively, which is suitable for fluorescent lamp ballasts, PDP scan drivers, motor controls, etc.

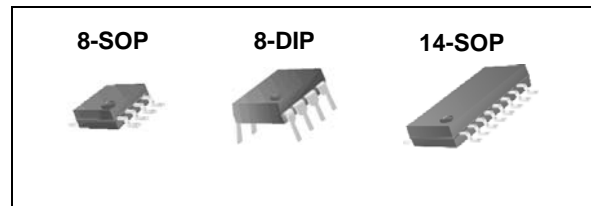

Ordering Information

Part Number	Package	Pb-Free	Operating Temperature Range	Packing Method
FAN7382N	8-DIP	Yes	-40°C ~ 125°C	Tube
FAN7382M ⁽¹⁾	8-SOP			Tube
FAN7382MX ⁽¹⁾				Tape & Reel
FAN7382M1 ⁽¹⁾	14-SOP			Tube
FAN7382M1X ⁽¹⁾				Tape & Reel

Note:

1. These devices passed wave soldering test by JESD22A-111.

Pin Assignments

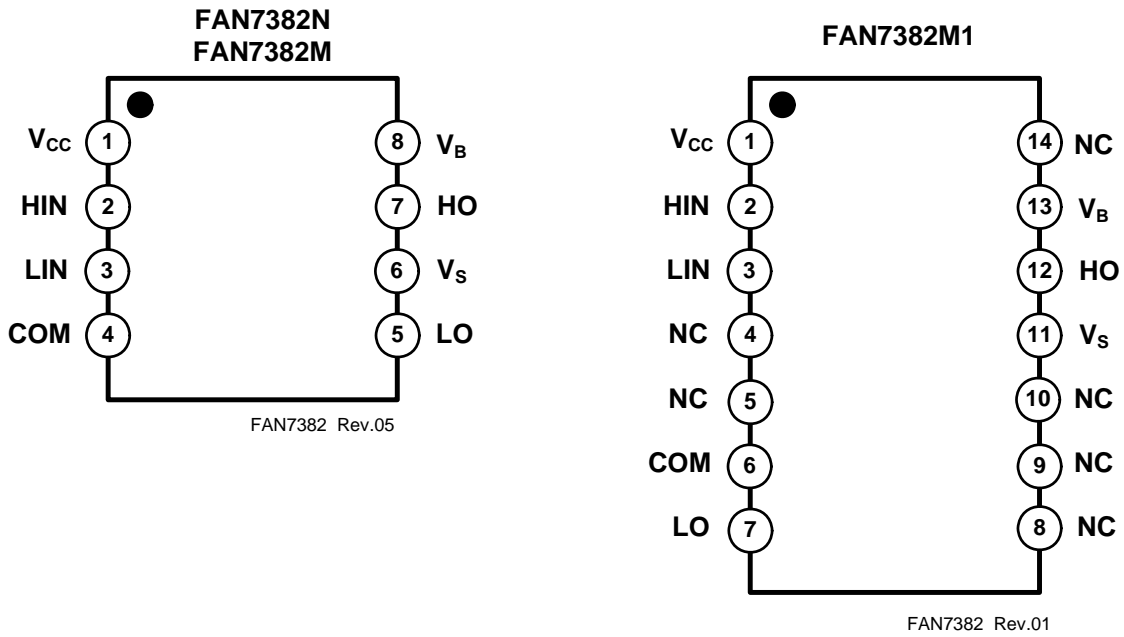

Figure 3. Pin Configuration (Top View)

Pin Definitions

Name	Description
V _{CC}	Low-Side Supply Voltage
HIN	Logic Input for High-Side Gate Driver Output
LIN	Logic Input for Low-Side Gate Driver Output
COM	Logic Ground and Low-Side Driver Return
LO	Low-Side Driver Output
V _S	High-Voltage Floating Supply Return
HO	High-Side Driver Output
V _B	High-Side Floating Supply

Absolute Maximum Ratings

Stresses exceeding the absolute maximum ratings may damage the device. The device may not function or be operable above the recommended operating conditions and stressing the parts to these levels is not recommended. In addition, extended exposure to stresses above the recommended operating conditions may affect device reliability. The absolute maximum ratings are stress ratings only.

Symbol	Characteristics	Min.	Max.	Unit
V_S	High-side offset voltage	V_B-25	$V_B+0.3$	V
V_B	High-side floating supply voltage	-0.3	625	
V_{HO}	High-side floating output voltage HO	$V_S-0.3$	$V_B+0.3$	
V_{CC}	Low-side and logic fixed supply voltage	-0.3	25	
V_{LO}	Low-side output voltage LO	-0.3	$V_{CC}+0.3$	
V_{IN}	Logic input voltage (HIN, LIN)	-0.3	$V_{CC}+0.3$	
COM	Logic ground	$V_{CC}-25$	$V_{CC}+0.3$	
dV_S/dt	Allowable offset voltage slew rate		50	V/ns
$P_D^{(2)(3)(4)}$	Power dissipation	8-SOP	0.625	W
		14-SOP	1.0	
		8-DIP	1.2	
θ_{JA}	Thermal resistance, junction-to-ambient	8-SOP	200	°C/W
		14-SOP	110	
		8-DIP	100	
T_J	Junction temperature		150	°C
T_{STG}	Storage temperature		150	°C

Notes:

- Mounted on 76.2 x 114.3 x 1.6mm PCB (FR-4 glass epoxy material).
- Refer to the following standards:
 - JESD51-2: Integral circuits thermal test method environmental conditions - natural convection
 - JESD51-3: Low effective thermal conductivity test board for leaded surface mount packages
- Do not exceed P_D under any circumstances.

Recommended Operating Ratings

The Recommended Operating Conditions table defines the conditions for actual device operation. Recommended operating conditions are specified to ensure optimal performance to the datasheet specifications. Fairchild does not recommend exceeding them or designing to Absolute Maximum Ratings.

Symbol	Parameter	Min.	Max.	Unit
V_B	High-side floating supply voltage	V_S+10	V_S+20	V
V_S	High-side floating supply offset voltage	$6-V_{CC}$	600	
V_{HO}	High-side (HO) output voltage	V_S	V_B	
V_{LO}	Low-side (LO) output voltage	COM	V_{CC}	
V_{IN}	Logic input voltage (HIN, LIN)	COM	V_{CC}	
V_{CC}	Low-side supply voltage	10	20	
T_A	Ambient temperature	-40	125	°C

Electrical Characteristics

V_{BIAS} (V_{CC} , V_{BS})=15.0V, $T_A = 25^\circ\text{C}$, unless otherwise specified. The V_{IN} and I_{IN} parameters are referenced to COM. The V_O and I_O parameters are referenced to V_S and COM and are applicable to the respective outputs HO and LO.

Symbol	Characteristics	Test Condition	Min.	Typ.	Max.	Unit
V_{CCUV+} V_{BSUV+}	V_{CC} and V_{BS} supply under-voltage positive going threshold		8.2	9.2	10.0	V
V_{CCUV-} V_{BSUV-}	V_{CC} and V_{BS} supply under-voltage negative going threshold		7.6	8.7	9.6	
V_{CCUVH} V_{BSUVH}	V_{CC} supply under-voltage lockout hysteresis			0.6		
I_{LK}	Offset supply leakage current	$V_B=V_S=600\text{V}$			50	μA
I_{QBS}	Quiescent V_{BS} supply current	$V_{IN}=0\text{V}$ or 5V		45	120	
I_{QCC}	Quiescent V_{CC} supply current	$V_{IN}=0\text{V}$ or 5V		70	180	
I_{PBS}	Operating V_{BS} supply current	$f_{IN}=20\text{kHz}$, rms value			600	μA
I_{PCC}	Operating V_{CC} supply current	$f_{IN}=20\text{kHz}$, rms value			600	
V_{IH}	Logic "1" input voltage		2.9			V
V_{IL}	Logic "0" input voltage				0.8	
V_{OH}	High-level output voltage, $V_{BIAS}-V_O$	$I_O=20\text{mA}$			1.0	
V_{OL}	Low-level output voltage, V_O				0.6	
I_{IN+}	Logic "1" input bias current	$V_{IN}=5\text{V}$		10	20	μA
I_{IN-}	Logic "0" input bias current	$V_{IN}=0\text{V}$		1.0	2.0	
I_{O+}	Output high short-circuit pulsed current	$V_O=0\text{V}$, $V_{IN}=5\text{V}$ with $PW<10\mu\text{s}$	250	350		mA
I_{O-}	Output low short-circuit pulsed current	$V_O=15\text{V}$, $V_{IN}=0\text{V}$ with $PW<10\mu\text{s}$	500	650		
V_S	Allowable negative V_S pin voltage for HIN signal propagation to HO			-9.8	-7.0	V

Dynamic Electrical Characteristics

V_{BIAS} (V_{CC} , V_{BS})=15.0V, $V_S=\text{COM}$, $C_L=1000\text{pF}$ and, $T_A = 25^\circ\text{C}$, unless otherwise specified.

Symbol	Characteristics	Test Condition	Min.	Typ.	Max.	Unit
t_{on}	Turn-on propagation delay	$V_S=0\text{V}$	100	170	300	ns
t_{off}	Turn-off propagation delay	$V_S=0\text{V}$ or $600\text{V}^{(5)}$	100	200	300	
t_r	Turn-on rise time		20	60	140	
t_f	Turn-off fall time			30	80	
MT	Delay matching, HS & LS turn-on/off				50	

Note:

5. This parameter guaranteed by design.

Typical Characteristics

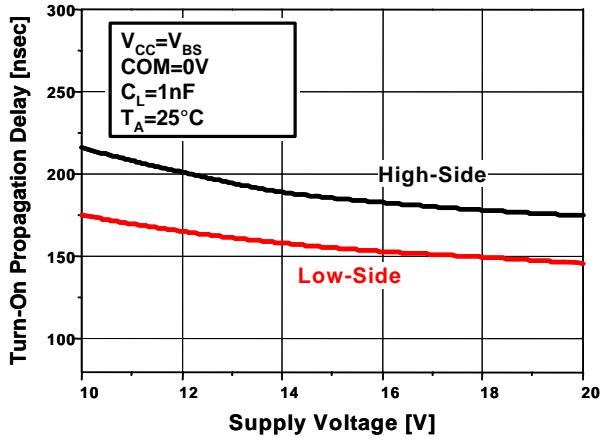

Figure 4. Turn-On Propagation Delay vs. Supply Voltage

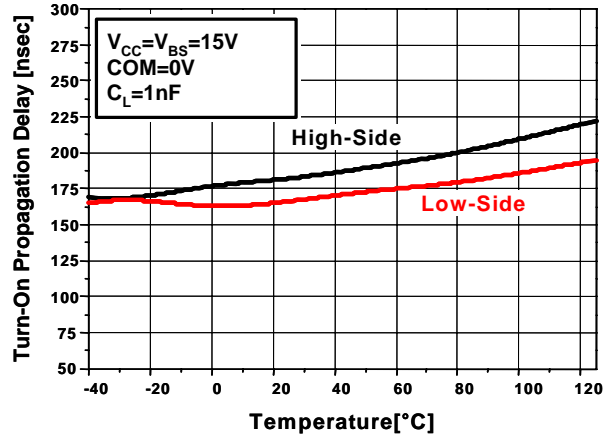

Figure 5. Turn-On Propagation Delay vs. Temp.

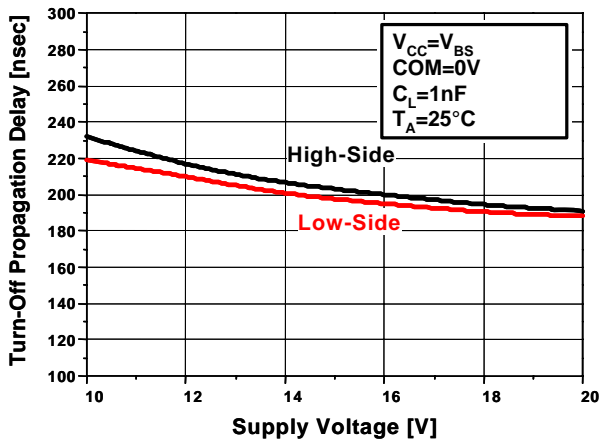

Figure 6. Turn-Off Propagation Delay vs. Supply Voltage

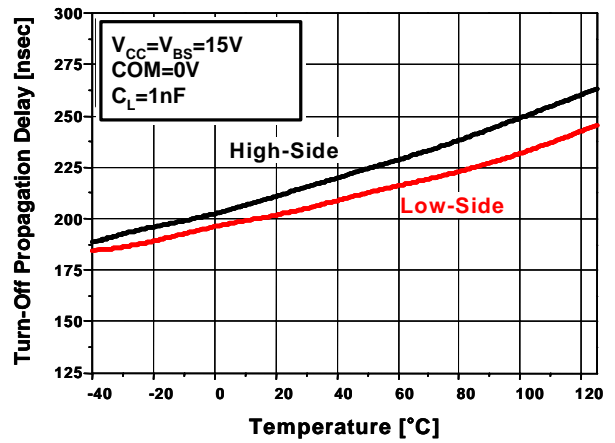

Figure 7. Turn-Off Propagation Delay vs. Temp.

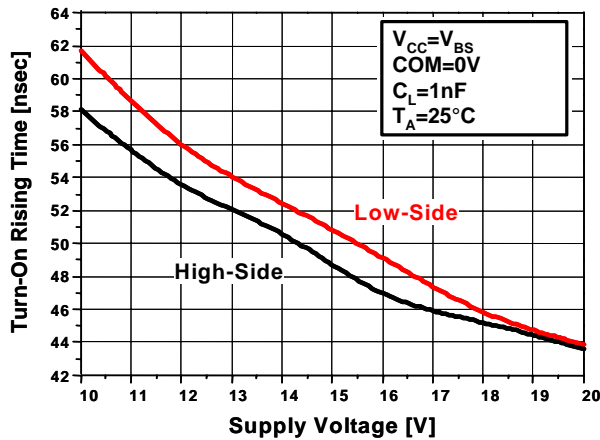

Figure 8. Turn-On Rising Time vs. Supply Voltage

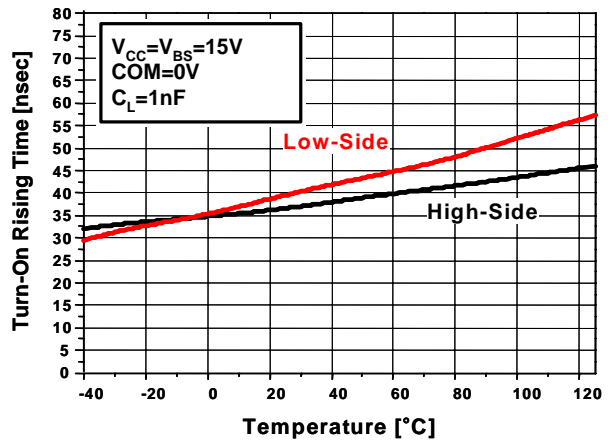

Figure 9. Turn-On Rising Time vs. Temp.

Typical Characteristics (Continued)

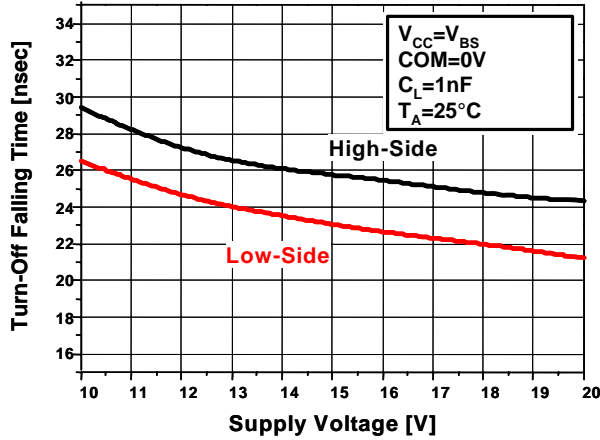

Figure 10. Turn-Off Falling Time vs. Supply Voltage

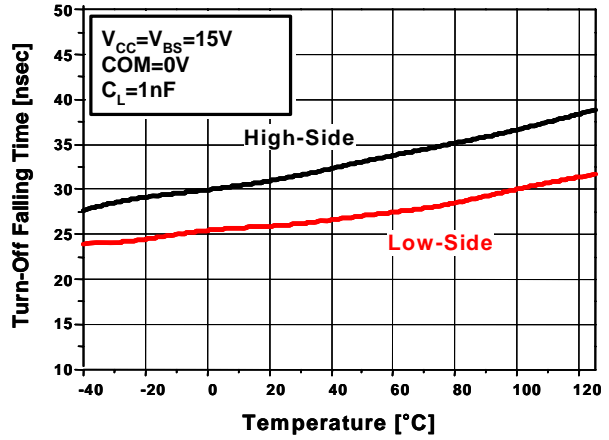

Figure 11. Turn-Off Falling Time vs. Temp.

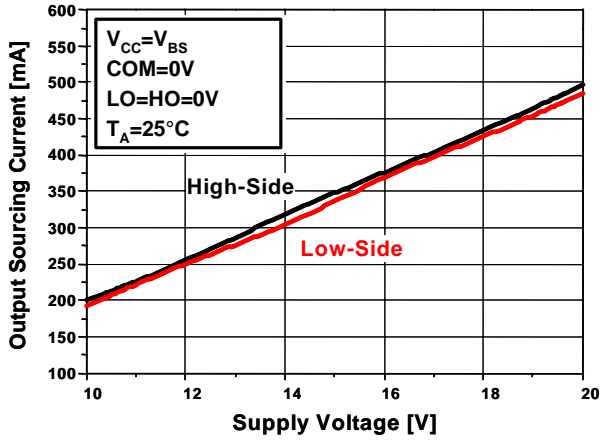

Figure 12. Output Sourcing Current vs. Supply Voltage

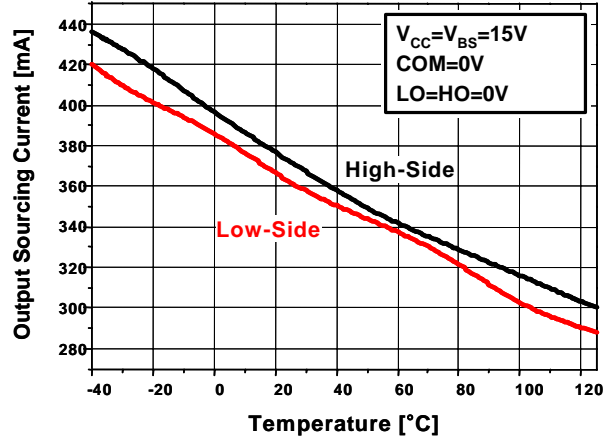

Figure 13. Output Sourcing Current vs. Temp

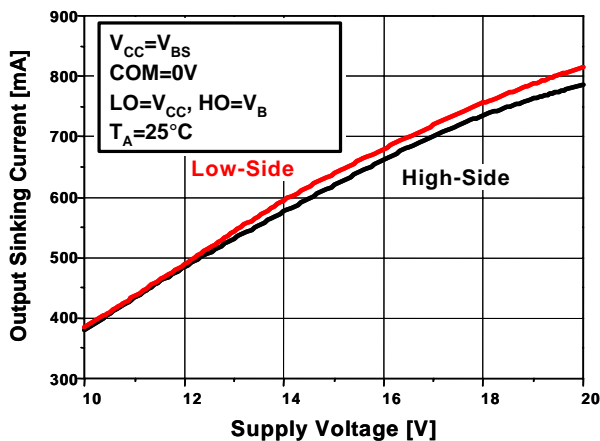

Figure 14. Output Sinking Current vs. Supply Voltage

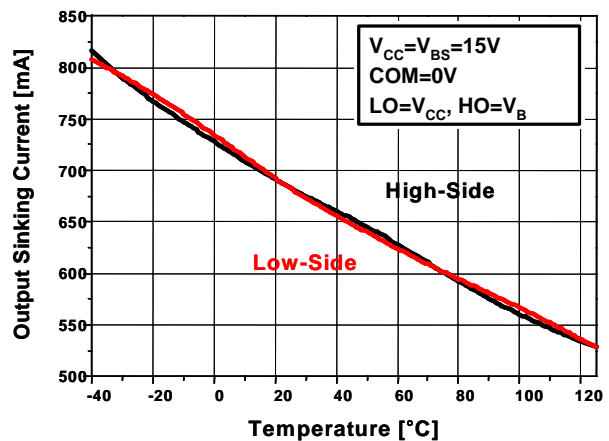

Figure 15. Output Sinking Current vs. Temp.

Typical Characteristics (Continued)

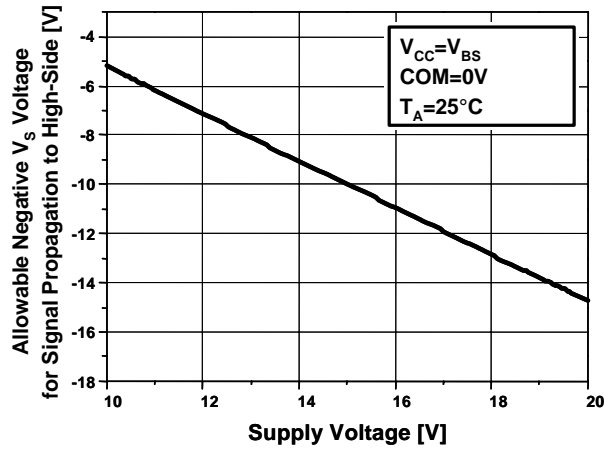

Figure 16. Allowable Negative V_S Voltage for Signal Propagation to High Side vs. Supply Voltage

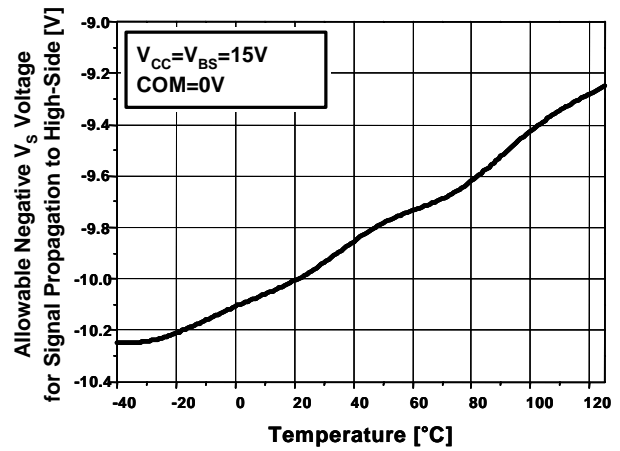

Figure 17. Allowable Negative V_S Voltage for Signal Propagation to High Side vs. Temp.

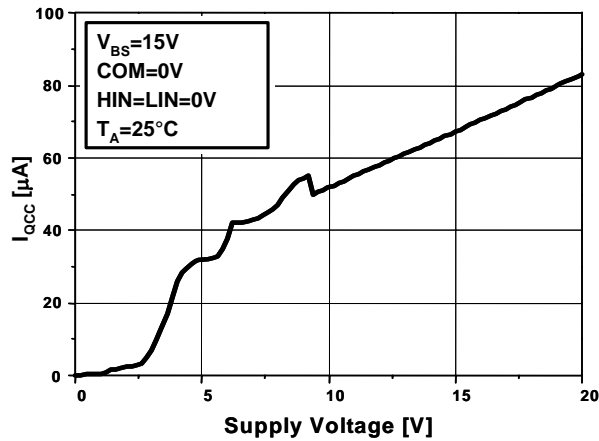

Figure 18. I_{QCC} vs. Supply Voltage

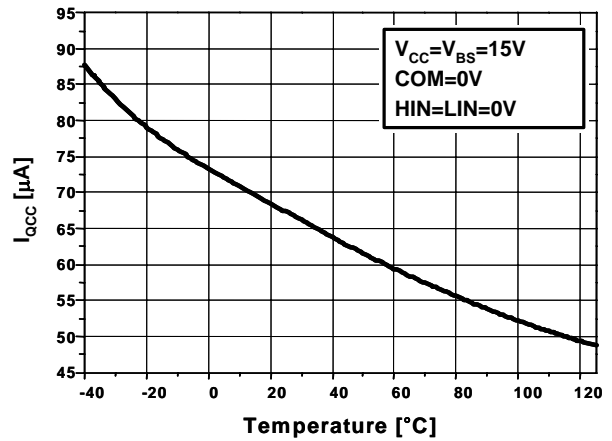

Figure 19. I_{QCC} vs. Temp.

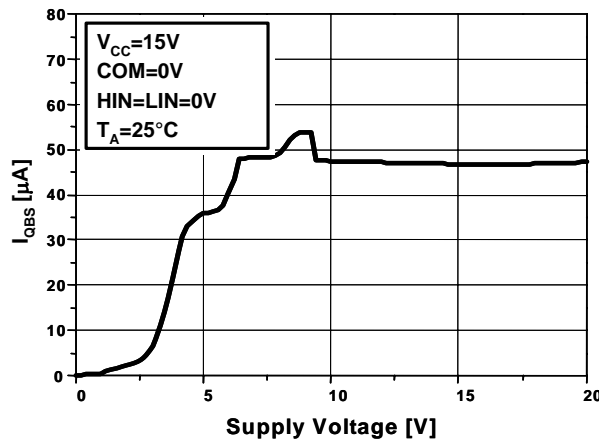

Figure 20. I_{QBS} vs. Supply Voltage

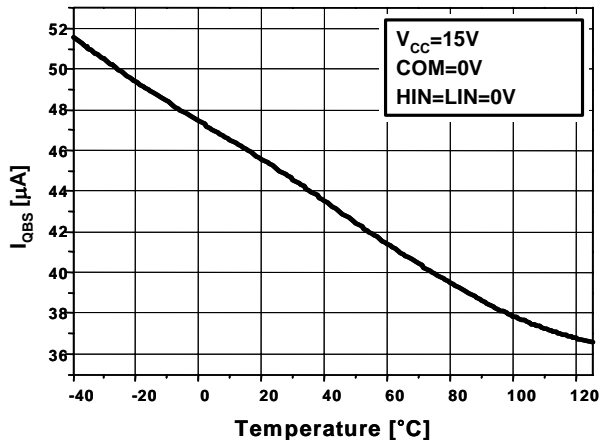

Figure 21. I_{QBS} vs. Temp.

Typical Characteristics (Continued)

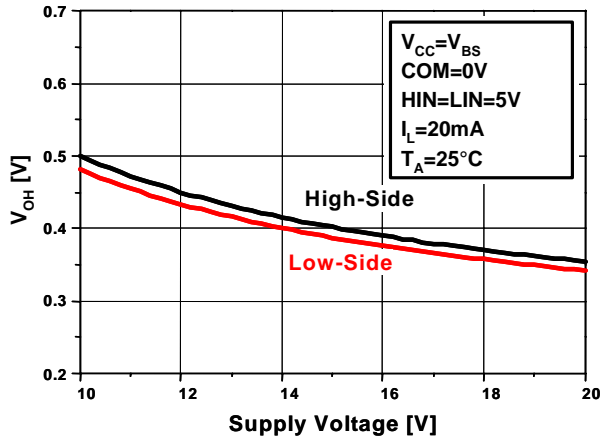

Figure 22. High-Level Output Voltage vs. Supply Voltage

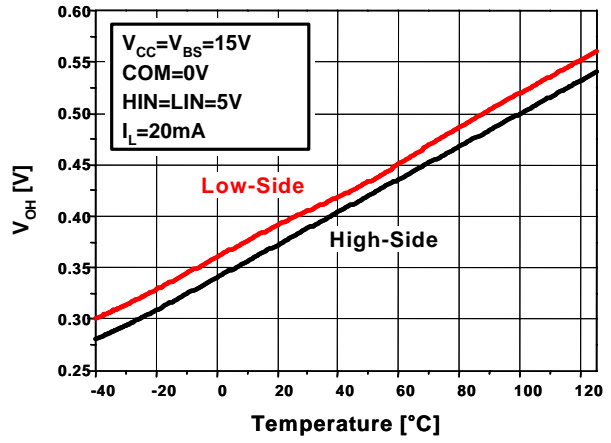

Figure 23. High-Level Output Voltage vs. Temp.

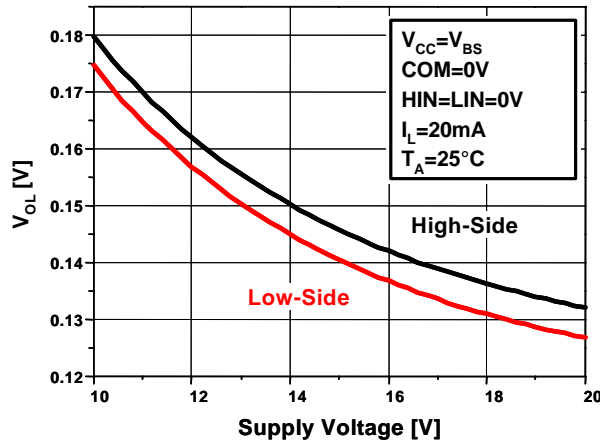

Figure 24. Low-Level Output Voltage vs. Supply Voltage

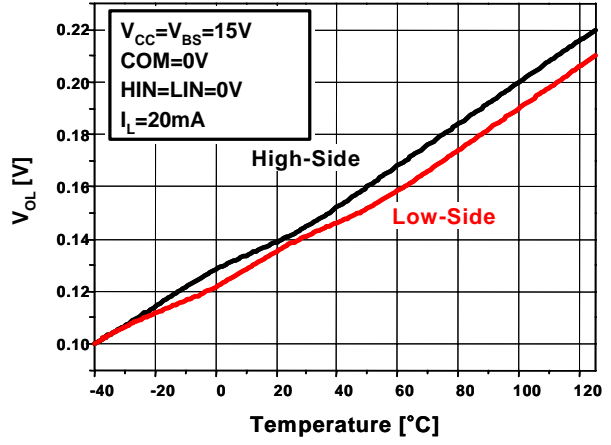

Figure 25. Low-Level Output Voltage vs. Temp.

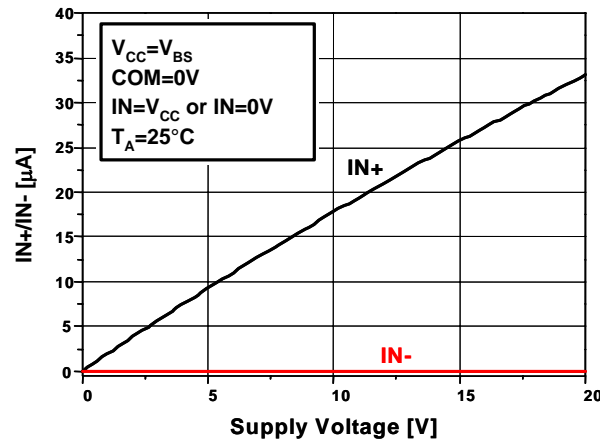

Figure 26. Input Bias Current vs. Supply Voltage

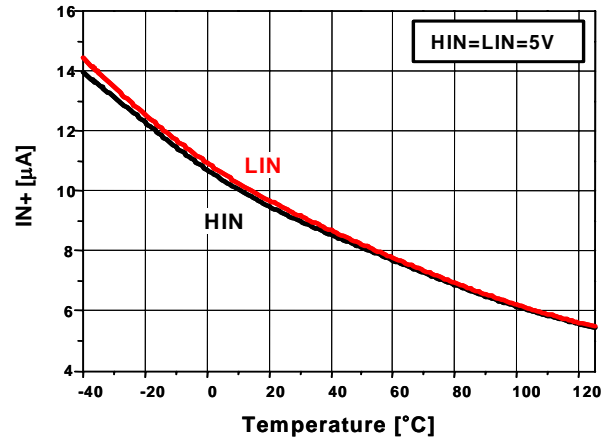

Figure 27. Input Bias Current vs. Temp.

Typical Characteristics (Continued)

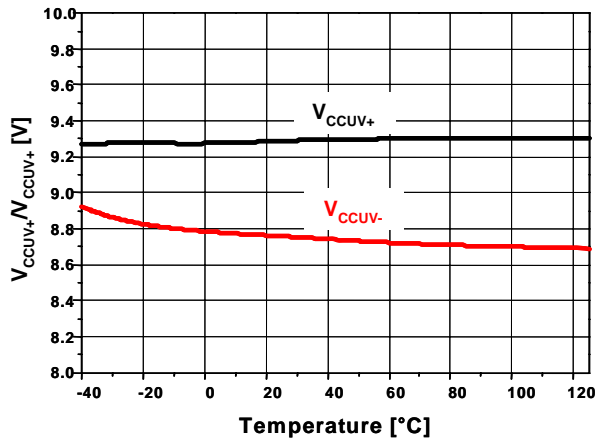

Figure 28. V_{CC} UVLO Threshold Voltage vs. Temp.

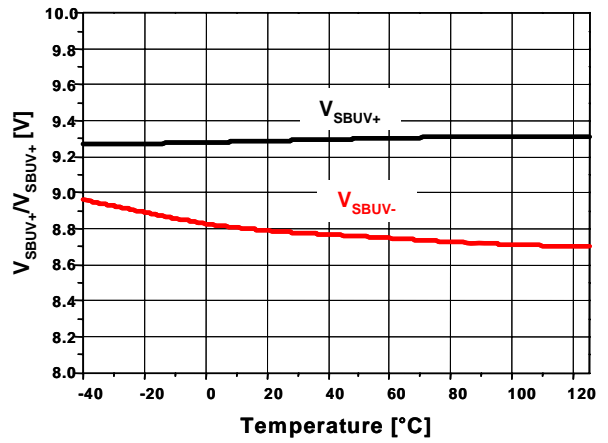

Figure 29. V_{BS} UVLO Threshold Voltage vs. Temp.

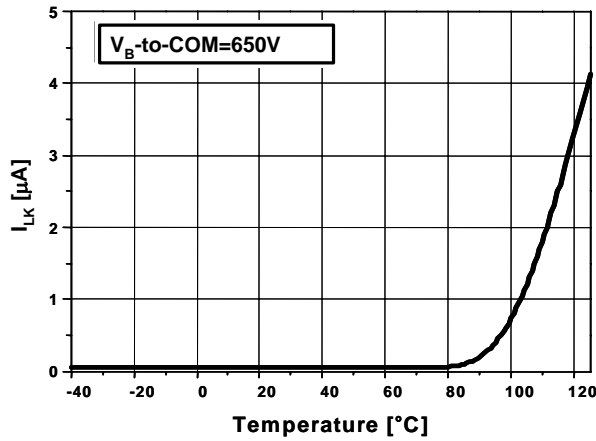

Figure 30. V_B to COM Leakage Current vs. Temp.

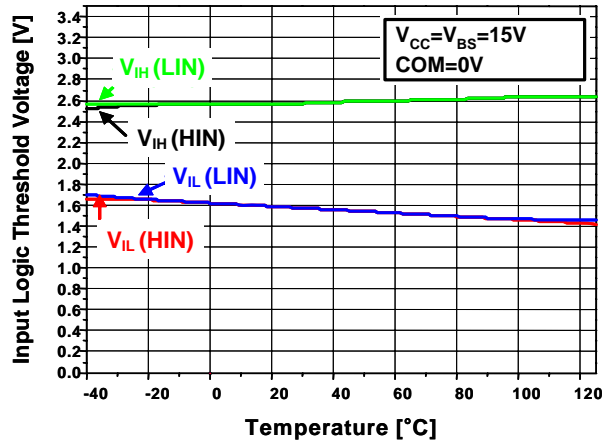

Figure 31. Input Logic Threshold Voltage vs. Temp.

Typical Characteristics (Continued)

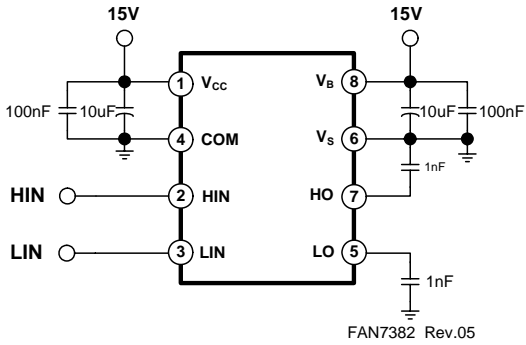

Figure 32. Switching Time Test Circuit

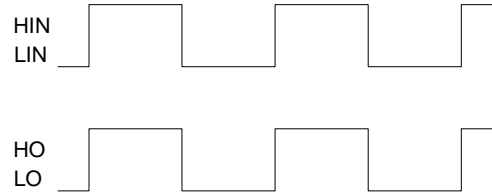

Figure 33. Input / Output Timing Diagram

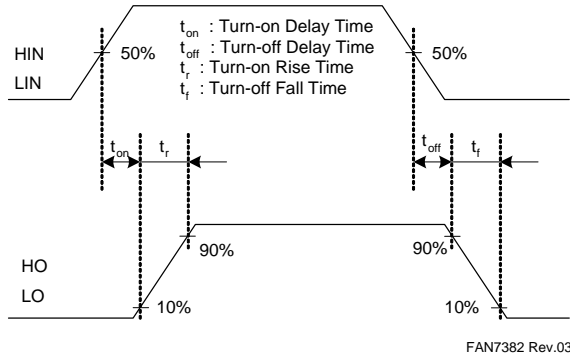

Figure 34. Switching Time Waveform Definition

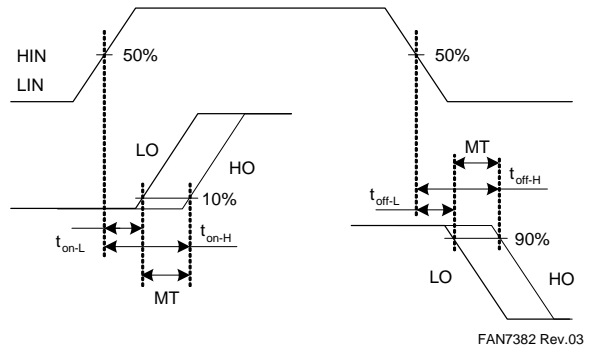
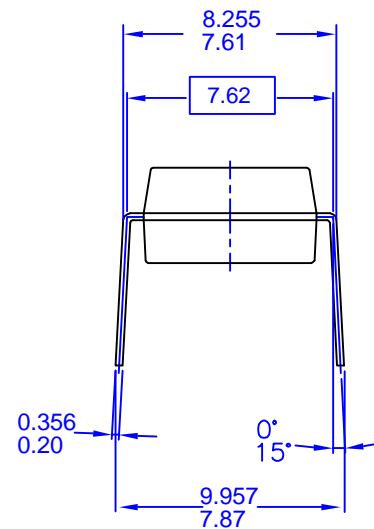
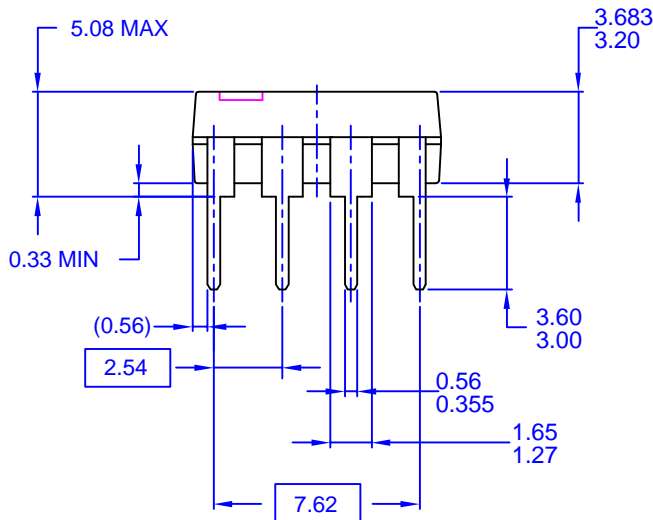
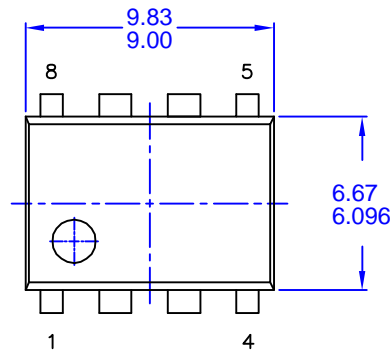

Figure 35. Delay Matching Waveform Definition

THIS DRAWING IS THE PROPERTY OF FAIRCHILD SEMICONDUCTOR CORPORATION. NO USE THEREOF SHALL BE MADE OTHER THAN AS A REFERENCE FOR PROPOSALS AS SUBMITTED TO FAIRCHILD SEMICONDUCTOR CORPORATION FOR JOBS TO BE EXECUTED IN CONFORMITY WITH SUCH PROPOSALS UNLESS THE CONSENT OF SAID FAIRCHILD SEMICONDUCTOR CORPORATION HAS PREVIOUSLY BEEN OBTAINED. NO PART OF THIS DRAWING SHALL BE COPIED OR DUPLICATED OR ITS CONTENTS DISCLOSED. THE INFORMATION CONTAINED ON THIS DRAWING IS CONFIDENTIAL AND PROPRIETARY.

REVISIONS

LTR	DESCRIPTION	E.D.C.N.	DATE	BY/APP'D
A	RELEASE TO DOCUMENT CONTROL		05APR2004	OS.JEON
2	Dimension Composition	ECN-MKT-N08FR2	2AUG 2007	H.ALLEN



- NOTES: UNLESS OTHERWISE SPECIFIED
- A) THIS PACKAGE CONFORMS TO JEDEC MS-001 VARIATION BA
 - B) ALL DIMENSIONS ARE IN MILLIMETERS.
 - C) DIMENSIONS ARE EXCLUSIVE OF BURRS, MOLD FLASH, AND TIE BAR EXTRUSIONS.
 - D) DIMENSIONS AND TOLERANCES PER ASME Y14.5M-1994
 - E) DRAWING FILENAME AND REVSION: MKT-N08FREV2.

APPROVALS		DATE	FAIRCHILD SEMICONDUCTOR		
DRAWN: J. H MOON		22MAY2007	8LD, MDIP, JEDEC MS-001 .300" WIDE		
CHECKED: J. H MOON		22MAY2007			
APPROVED: T. S KIM		22MAY2007			
		SCALE 1:1	SIZE NA	DRAWING NUMBER MKT-N08F	REV 2
		FORMERLY: N/A	SHEET : 1 OF 1		

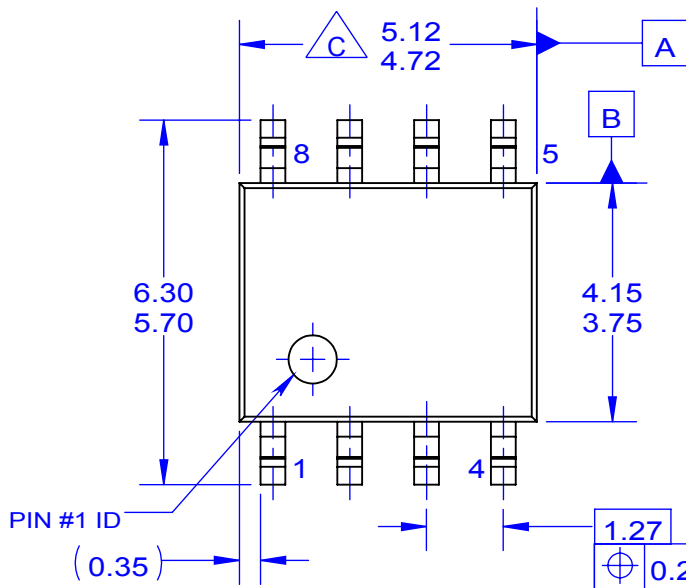

TOP VIEW

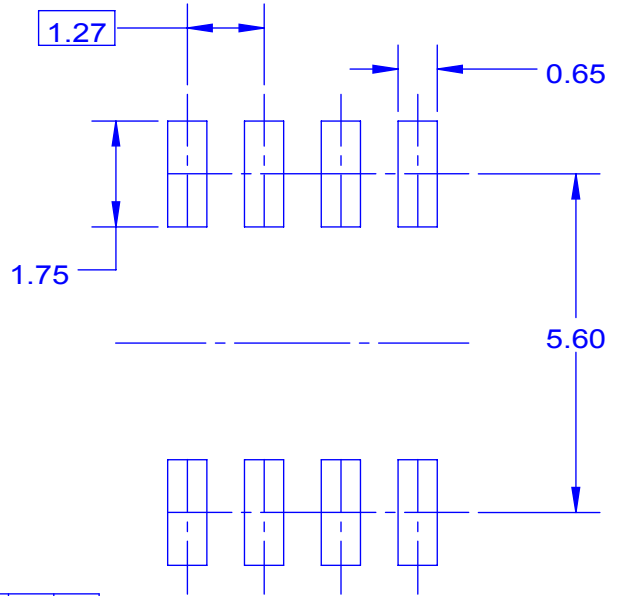

LAND PATTERN RECOMMENDATION

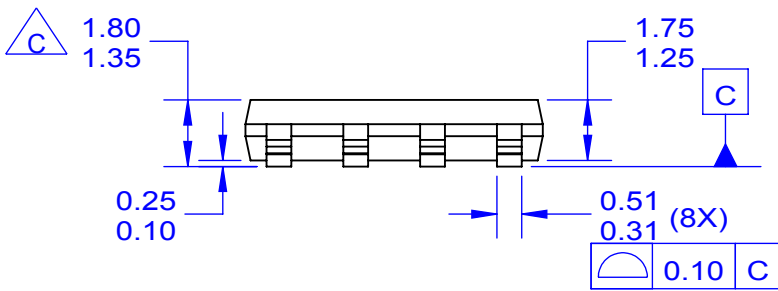

FRONT VIEW

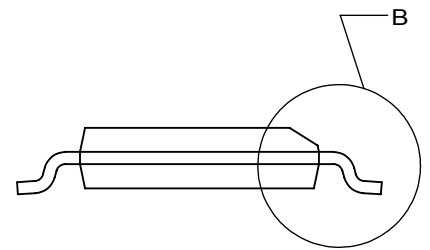

OPTION A - BEVEL EDGE

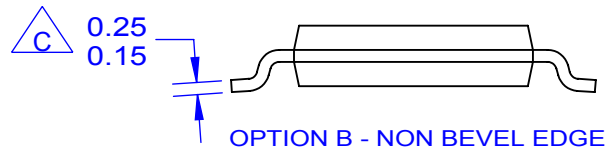

OPTION B - NON BEVEL EDGE

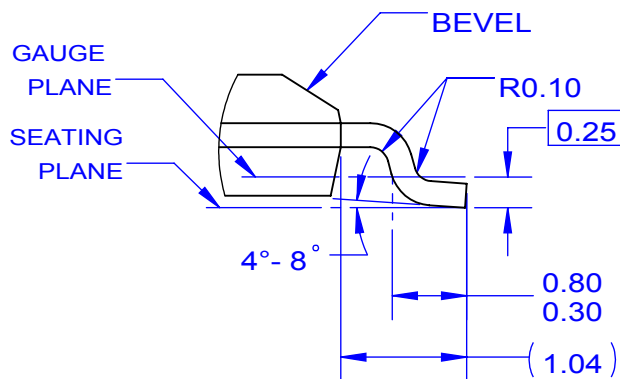

DETAIL "B"
SCALE 2:1

NOTES: UNLESS OTHERWISE SPECIFIED

- A. THIS PACKAGE CONFORMS TO JEDEC MS-012 VARIATION A EXCEPT WHERE NOTED.
- B. ALL DIMENSIONS ARE IN MILLIMETERS.

OUT OF JEDEC STANDARD VALUE.

- D. DIMENSIONS ARE EXCLUSIVE OF BURRS, MOLD FLASH AND TIE BAR EXTRUSIONS.
- E. LAND PATTERN AS PER IPC SOIC127P600X175-8M
- F. FILE NAME: MKT-M08B REV1



TRADEMARKS

The following includes registered and unregistered trademarks and service marks, owned by Fairchild Semiconductor and/or its global subsidiaries, and is not intended to be an exhaustive list of all such trademarks.

- AccuPower™
- AttitudeEngine™
- Awinda®
- AX-CAP®*
- BitSiC™
- Build it Now™
- CorePLUS™
- CorePOWER™
- CROSSVOL™
- CTL™
- Current Transfer Logic™
- DEUXPEED®
- Dual Cool™
- EcoSPARK®
- EfficientMax™
- ESBC™
- F**™
- Fairchild®
- Fairchild Semiconductor®
- FACT Quiet Series™
- FACT®
- FastvCore™
- FETBench™
- FPS™
- F-PFS™
- FRFET®
- Global Power ResourceSM
- GreenBridge™
- Green FPS™
- Green FPS™ e-Series™
- Gmax™
- GTO™
- IntelliMAX™
- ISOPLANAR™
- Making Small Speakers Sound Louder and Better™
- MegaBuck™
- MICROCOUPLER™
- MicroFET™
- MicroPak™
- MicroPak2™
- MillerDrive™
- MotionMax™
- MotionGrid®
- MTi®
- MTx®
- MVN®
- mWSaver®
- OptoHiT™
- OPTOLOGIC®
- OPTOPLANAR®
- ®
- Power Supply WebDesigner™
- PowerTrench®
- PowerXS™
- Programmable Active Droop™
- QFET®
- QS™
- Quiet Series™
- RapidConfigure™
- ™
- Saving our world, 1mW/W/kW at a time™
- SignalWise™
- SmartMax™
- SMART START™
- Solutions for Your Success™
- SPM®
- STEALTH™
- SuperFET®
- SuperSOT™-3
- SuperSOT™-6
- SuperSOT™-8
- SupreMOS®
- SyncFET™
- Sync-Lock™
- ®
- TinyBoost®
- TinyBuck®
- TinyCalc™
- TinyLogic®
- TINYOPTO™
- TinyPower™
- TinyPWM™
- TinyWire™
- TranSiC™
- TriFault Detect™
- TRUECURRENT®*
- μSerDes™
- ™
- UHC®
- Ultra FRFET™
- UniFET™
- VcX™
- VisualMax™
- VoltagePlus™
- XS™
- Xsens™
- 仙童®

* Trademarks of System General Corporation, used under license by Fairchild Semiconductor.

DISCLAIMER

FAIRCHILD SEMICONDUCTOR RESERVES THE RIGHT TO MAKE CHANGES WITHOUT FURTHER NOTICE TO ANY PRODUCTS HEREIN TO IMPROVE RELIABILITY, FUNCTION, OR DESIGN. TO OBTAIN THE LATEST, MOST UP-TO-DATE DATASHEET AND PRODUCT INFORMATION, VISIT OUR WEBSITE AT [HTTP://WWW.FAIRCHILDSEMI.COM](http://www.fairchildsemi.com). FAIRCHILD DOES NOT ASSUME ANY LIABILITY ARISING OUT OF THE APPLICATION OR USE OF ANY PRODUCT OR CIRCUIT DESCRIBED HEREIN; NEITHER DOES IT CONVEY ANY LICENSE UNDER ITS PATENT RIGHTS, NOR THE RIGHTS OF OTHERS. THESE SPECIFICATIONS DO NOT EXPAND THE TERMS OF FAIRCHILD'S WORLDWIDE TERMS AND CONDITIONS, SPECIFICALLY THE WARRANTY THEREIN, WHICH COVERS THESE PRODUCTS.

AUTHORIZED USE

Unless otherwise specified in this data sheet, this product is a standard commercial product and is not intended for use in applications that require extraordinary levels of quality and reliability. This product may not be used in the following applications, unless specifically approved in writing by a Fairchild officer: (1) automotive or other transportation, (2) military/aerospace, (3) any safety critical application – including life critical medical equipment – where the failure of the Fairchild product reasonably would be expected to result in personal injury, death or property damage. Customer's use of this product is subject to agreement of this Authorized Use policy. In the event of an unauthorized use of Fairchild's product, Fairchild accepts no liability in the event of product failure. In other respects, this product shall be subject to Fairchild's Worldwide Terms and Conditions of Sale, unless a separate agreement has been signed by both Parties.

ANTI-COUNTERFEITING POLICY

Fairchild Semiconductor Corporation's Anti-Counterfeiting Policy. Fairchild's Anti-Counterfeiting Policy is also stated on our external website, www.fairchildsemi.com, under Terms of Use

Counterfeiting of semiconductor parts is a growing problem in the industry. All manufacturers of semiconductor products are experiencing counterfeiting of their parts. Customers who inadvertently purchase counterfeit parts experience many problems such as loss of brand reputation, substandard performance, failed applications, and increased cost of production and manufacturing delays. Fairchild is taking strong measures to protect ourselves and our customers from the proliferation of counterfeit parts. Fairchild strongly encourages customers to purchase Fairchild parts either directly from Fairchild or from Authorized Fairchild Distributors who are listed by country on our web page cited above. Products customers buy either from Fairchild directly or from Authorized Fairchild Distributors are genuine parts, have full traceability, meet Fairchild's quality standards for handling and storage and provide access to Fairchild's full range of up-to-date technical and product information. Fairchild and our Authorized Distributors will stand behind all warranties and will appropriately address any warranty issues that may arise. Fairchild will not provide any warranty coverage or other assistance for parts bought from Unauthorized Sources. Fairchild is committed to combat this global problem and encourage our customers to do their part in stopping this practice by buying direct or from authorized distributors.

PRODUCT STATUS DEFINITIONS

Definition of Terms

Datasheet Identification	Product Status	Definition
Advance Information	Formative / In Design	Datasheet contains the design specifications for product development. Specifications may change in any manner without notice.
Preliminary	First Production	Datasheet contains preliminary data; supplementary data will be published at a later date. Fairchild Semiconductor reserves the right to make changes at any time without notice to improve design.
No Identification Needed	Full Production	Datasheet contains final specifications. Fairchild Semiconductor reserves the right to make changes at any time without notice to improve the design.
Obsolete	Not In Production	Datasheet contains specifications on a product that is discontinued by Fairchild Semiconductor. The datasheet is for reference information only.

Rev. I77