



Biscuit DC (DC Blower)

COMAIR ROTRON PART NUMBER: **030960**
 COMAIR ROTRON MODEL NUMBER: **BD12S3H**



MOTOR	
Rated Voltage:	12
Operating Voltage Range:	6 - 14
Running Current: 50Hz 60Hz (amps)	
Locked Rotor Current: (amps)	0.8
Rated Power: 50Hz 60Hz (watts)	
Nominal Speed: 50Hz 60Hz (rpm)	

MECHANICAL	
Dimensions:	120.7mm x 31.0mm (4.75in x 1.22in)
Bearing Type:	Ball
Motor Base:	Lexan 500, Black, UL94V-0
Propeller:	Polypropylene, Black, UL94V-0

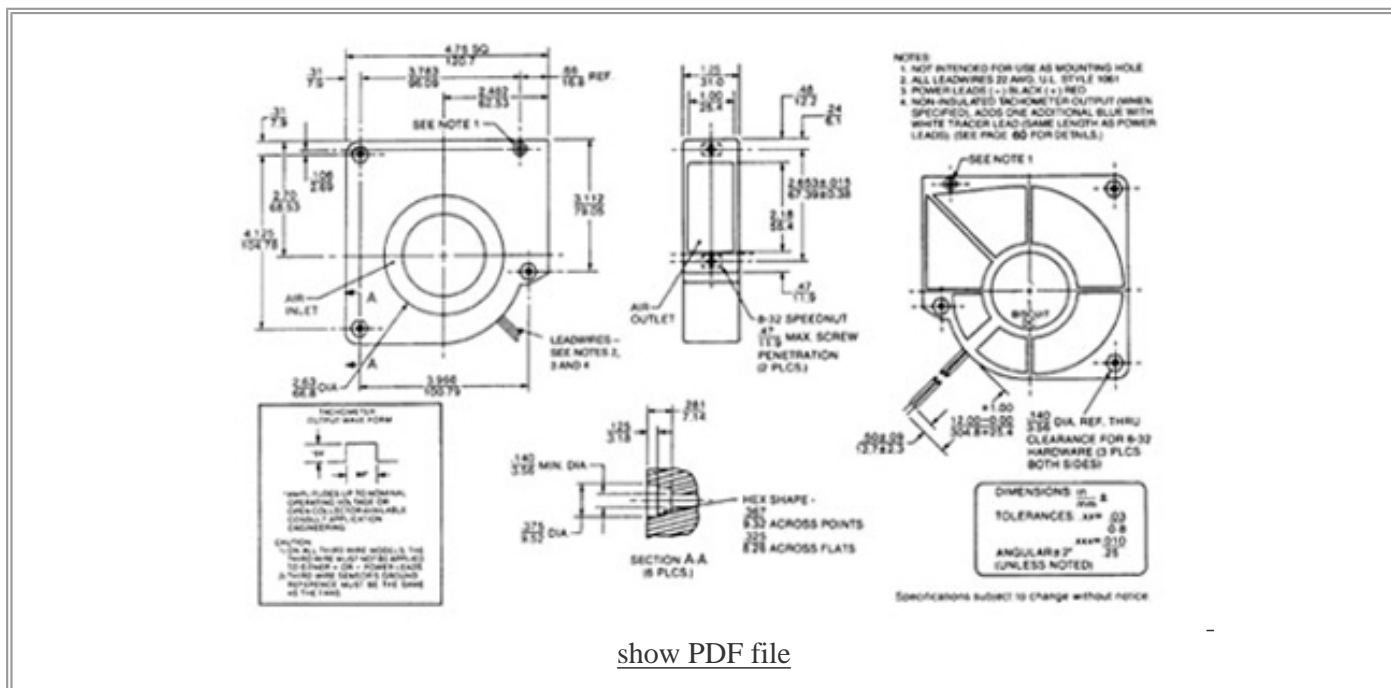

[show PDF file](#)

NOTES

Thermal Speed Control - PTC on 24" Zip Cord

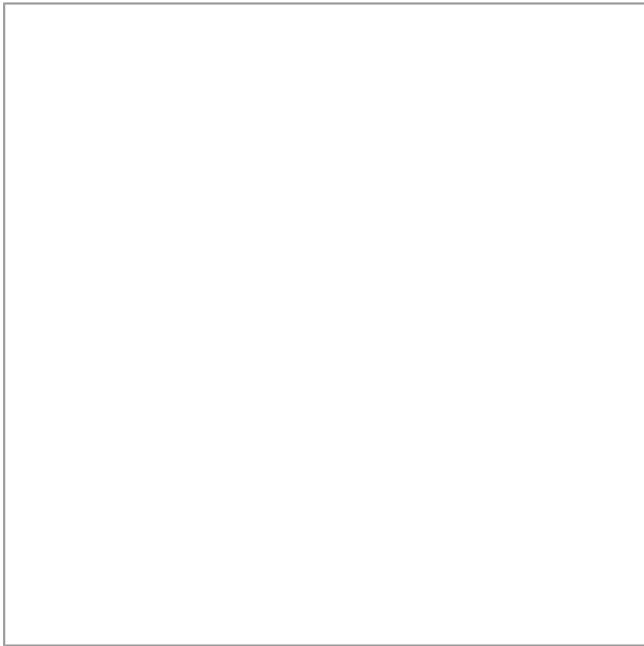

PERFORMANCE CHARACTERISTICS

Air Flow: (CFM) 23

Static Pressure: .770

TERMINATION

Leadwires: 12" Leadwires

SAFETY

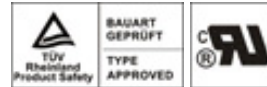

All product names are used under license and are trademarks or registered trademarks of Comair Rotron, Inc.

[New Search](#)