

HCPL3700

AC/DC to Logic Interface Optocoupler

Features

- AC or DC input
- Programmable sense voltage
- Logic level compatibility
- Threshold guaranteed over temperature (0°C to 70°C)
- Optoplanar™ construction for high common mode immunity
- UL recognized (file # E90700)
- VDE certified – ordering option 'V', e.g., HCPL3700V

Applications

- Low voltage detection
- 5 V to 240 V AC/DC voltage sensing
- Relay contact monitor
- Current sensing
- Microprocessor Interface
- Industrial controls

Description

The HCPL-3700 voltage/current threshold detection optocoupler consists of an AlGaAs LED connected to a threshold sensing input buffer IC which are optically coupled to a high gain darlington output. The input buffer chip is capable of controlling threshold levels over a wide range of input voltages with a single resistor. The output is TTL and CMOS compatible.

Schematics

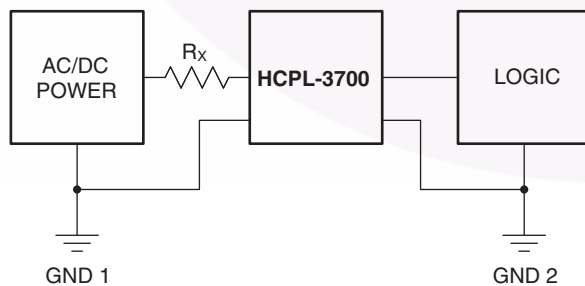
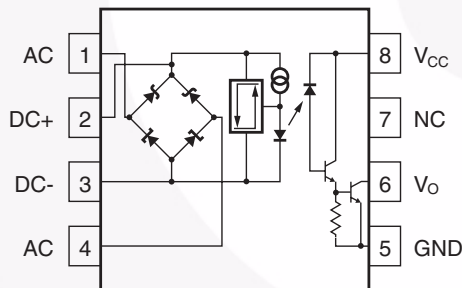

Package Outlines

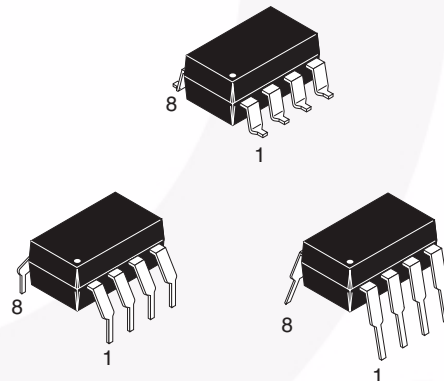

TRUTH TABLE
(Positive Logic)

Input	Output
H	L
L	H

A 0.1µF bypass capacitor must be connected between pins 8 and 5.

Absolute Maximum Ratings (No derating required up to 70°C)

Stresses exceeding the absolute maximum ratings may damage the device. The device may not function or be operable above the recommended operating conditions and stressing the parts to these levels is not recommended. In addition, extended exposure to stresses above the recommended operating conditions may affect device reliability. The absolute maximum ratings are stress ratings only.

Symbol	Parameter		Value	Units
T _{STG}	Storage Temperature		-55 to +125	°C
T _{OPR}	Operating Temperature		-40 to +85	°C
T _{SOL}	Lead Solder Temperature		260 for 10 sec	°C
EMITTER				
I _{IN}	Input Current	Average	50 (Max.)	mA
		Surge, 3ms, 120Hz Pulse Rate	140 (Max.)	
		Transient, 10µs, 120Hz Pulse Rate	500 (Max.)	
V _{IN}	Input Voltage (Pins 2-3)		-0.5 (Max.)	V
P _{IN}	Input Power Dissipation ⁽¹⁾		230 (Max.)	mW
P _T	Total Package Power Dissipation ⁽²⁾		305 (Max.)	mW
DETECTOR				
I _O	Output Current (Average) ⁽³⁾		30 (Max.)	mA
V _{CC}	Supply Voltage (Pins 8-5)		-0.5 to 20	V
V _O	Output Voltage (Pins 6-5)		-0.5 to 20	V
P _O	Output Power Dissipation ⁽⁴⁾		210 (Max.)	mW

Notes:

1. Derate linearly above 70°C free-air temperature at a rate of 1.8 mW/°C.
2. Derate linearly above 70°C free-air temperature at a rate of 2.5 mW/°C.
3. Derate linearly above 70°C free-air temperature at a rate of 0.6 mA/°C.
4. Derate linearly above 70°C free-air temperature at a rate of 1.9 mW/°C.

Recommended Operating Conditions

The Recommended Operating Conditions table defines the conditions for actual device operation. Recommended operating conditions are specified to ensure optimal performance to the datasheet specifications. Fairchild does not recommend exceeding them or designing to absolute maximum ratings.

Symbol	Parameter	Min.	Max.	Units
V _{CC}	Supply Voltage	2	18	V
T _A	Operating Temperature	0	70	°C
f	Operating Frequency	0	4	kHz

Electrical Characteristics ($T_A = 0^\circ\text{C}$ to 70°C Unless otherwise specified)

Symbol	Parameter		Test Conditions	Min.	Typ.	Max.	Unit
I_{TH+}	Input Threshold Current		$V_{IN} = V_{TH+}$, $V_{CC} = 4.5\text{ V}$	1.96	2.4	3.11	mA
I_{TH-}			$V_O = 0.4\text{ V}$, $I_O \geq 4.2\text{ mA}^{(5)}$	1.00	1.2	1.62	mA
V_{TH+}	Input Threshold Voltage	DC (Pins 2,3)	$V_{IN} = V_2 - V_3$ (Pins 1 & 4 Open) $V_{CC} = 4.5\text{ V}$, $V_O = 0.4\text{ V}^{(5)}$ $I_O \geq 4.2\text{ mA}$	3.35	3.8	4.05	V
V_{TH-}			$V_{IN} = V_2 - V_3$ (Pins 1 & 4 Open) $V_{CC} = 4.5\text{ V}$, $V_O = 2.4\text{ V}^{(5)}$ $I_O \geq 100\mu\text{A}$	2.01	2.5	2.86	V
V_{TH+}		AC (Pins 1,4)	$ V_{IN} = V_1 - V_4 $ (Pins 2 & 3 Open) $V_{CC} = 4.5\text{ V}$, $V_O = 0.4\text{ V}^{(5)}$ $I_O \geq 4.2\text{ mA}$	4.23	5.0	5.50	V
V_{TH-}			$ V_{IN} = V_1 - V_4 $ (Pins 2 & 3 Open) $V_{CC} = 4.5\text{ V}$, $V_O = 2.4\text{ V}^{(5)}$ $I_O \leq 100\mu\text{A}$	2.87	3.7	4.20	V
I_{HYS}	Hysteresis		$I_{HYS} = I_{TH+} - I_{TH-}$		1.2		mA
V_{HYS}			$V_{HYS} = V_{TH+} - V_{TH-}$		1.3		V
V_{IHC1}	Input Clamp Voltage		$V_{IHC1} = V_2 - V_3$, $V_3 = \text{GND}$ $I_{IN} = 10\text{ mA}$, Pins 1 & 4 connected to Pin 3	5.4	6.3	6.6	V
V_{IHC2}			$V_{IHC2} = V_1 - V_4 $, $ I_{IN} = 10\text{ mA}$ (Pins 2 & 3 Open)	6.1	7.0	7.3	V
V_{IHC3}			$V_{IHC3} = V_2 - V_3$, $V_3 = \text{GND}$, $I_{IN} = 15\text{ mA}$ (Pins 1 & 4 Open)		12.5	13.4	V
V_{ILC}			$V_{ILC} = V_2 - V_3$, $V_3 = \text{GND}$, $I_{IN} = -10\text{ mA}$		-0.75		V
I_{IN}	Input Current		$V_{IN} = V_2 - V_3 = 5.0\text{ V}$ (Pins 1 & 4 Open)	3.0	3.7	4.4	mA
$V_{D1,2}$	Bridge Diode		$I_{IN} = 3\text{ mA}$		0.65		V
$V_{D3,4}$	Forward Voltage		$I_{IN} = 3\text{ mA}$		0.65		V
V_{OL}	Logic LOW Output Voltage		$V_{CC} = 4.5\text{ V}$, $I_{OL} = 4.2\text{ mA}^{(5)}$		0.04	0.4	V
I_{OH}	Logic HIGH Output Current		$V_{OH} = V_{CC} = 18\text{ V}^{(5)}$			100	μA
I_{CCL}	Logic LOW Supply Current		$V_2 - V_3 = 5.0\text{ V}$, $V_O = \text{Open}$, $V_{CC} = 5\text{ V}$		1.0	4	mA
I_{CCH}	Logic HIGH Supply Current		$V_{CC} = 18\text{ V}$, $V_O = \text{Open}$		0.01	4	μA
C_{IN}	Input Capacitance		$f = 1\text{ MHz}$, $V_{IN} = 0\text{ V}$ (Pins 2 & 3, Pins 1 & 4 Open)		50		pF

Note:

- Logic LOW output level at pin 6 occurs when $V_{IN} \geq V_{TH+}$ and when $V_{IN} > V_{TH-}$ once V_{IN} exceeds V_{TH+} .
Logic HIGH output level at pin 6 occurs when $V_{IN} \leq V_{TH-}$ and when $V_{IN} < V_{TH+}$ once V_{IN} decreases below V_{TH-} .

Switching Characteristics ($T_A = 25^\circ\text{C}$, $V_{CC} = 5\text{ V}$ Unless otherwise specified)

Symbol	AC Characteristics	Test Conditions	Min.	Typ.	Max.	Unit
T_{PHL}	Propagation Delay Time (to Output Low Level)	$R_L = 4.7\text{k}\Omega$, $C_L = 30\text{pF}^{(6)}$		6.0	15	μs
T_{PLH}	Propagation Delay Time (to Output High Level)	$R_L = 4.7\text{k}\Omega$, $C_L = 30\text{pF}^{(6)}$		25.0	40	μs
t_r	Output Rise Time (10–90%)	$R_L = 4.7\text{k}\Omega$, $C_L = 30\text{pF}$		45		μs
t_f	Output Fall Time (90–10%)	$R_L = 4.7\text{k}\Omega$, $C_L = 30\text{pF}$		0.5		μs
ICM_{HI}	Common Mode Transient Immunity (at Output High Level)	$I_{IN} = 0\text{ mA}$, $R_L = 4.7\text{k}\Omega$, $V_{O\text{ min}} = 2.0\text{ V}$, $V_{CM} = 1400\text{V}^{(7)(8)}$		4000		$\text{V}/\mu\text{s}$
ICM_{LI}	Common Mode Transient Immunity (at Output Low Level)	$I_N = 3.11\text{mA}$, $R_L = 4.7\text{k}\Omega$, $V_{O\text{ max}} = 0.8\text{V}$, $V_{CM} = 140\text{V}^{(7)(8)}$		600		$\text{V}/\mu\text{s}$

Package Characteristics ($T_A = 0^\circ\text{C}$ to 70°C Unless otherwise specified)

Symbol	Characteristics	Test Conditions	Min.	Typ.	Max.	Unit
V_{ISO}	Withstand Insulation Voltage	Relative humidity < 50%, $T_A = 25^\circ\text{C}$, $t = 1\text{ min}$, $I_{I-O} \leq 2\mu\text{A}^{(9)(10)}$	2500			V_{RMS}
R_{I-O}	Resistance (input to output)	$V_{IO} = 500\text{Vdc}^{(9)}$		10^{12}		Ω
C_{I-O}	Capacitance (input to output)	$f = 1\text{MHz}$, $V_{IO} = 0\text{Vdc}$		0.6		pF

Notes:

- T_{PHL} propagation delay is measured from the 2.5V level of the leading edge of a 5.0V input pulse (1 μs rise time) to the 1.5 V level on the leading edge of the output pulse. T_{PLH} propagation delay is measured on the trailing edges of the input and output pulse. (Refer to Fig. 9)
- Common mode transient immunity in logic high level is the maximum tolerable (positive) dV_{cm}/dt on the leading edge of the common mode pulse signal V_{CM} , to assure that the output will remain in a logic high state (i.e., $V_O > 2.0\text{ V}$). Common mode transient immunity in logic low level is the maximum tolerable (negative) dV_{cm}/dt on the trailing edge of the common mode pulse signal, V_{CM} , to assure that the output will remain in a logic low state (i.e., $V_O < 0.8\text{ V}$). Refer to Fig. 10.
- In applications where dV_{cm}/dt may exceed 50,000 $\text{V}/\mu\text{s}$ (Such as static discharge), a series resistor, R_{CC} , should be included to protect the detector chip from destructive surge currents. The recommended value for R_{CC} is 240V per volt of allowable drop in V_{CC} (between pin 8 and V_{CC}) with a minimum value of 240 Ω .
- Device is considered a two terminal device: Pins 1, 2, 3 and 4 are shorted together and Pins 5, 6, 7 and 8 are shorted together.
- The 2500 $V_{RMS}/1\text{ min.}$ capability is validated by a 3.0 $\text{kV}_{RMS}/1\text{ sec.}$ dielectric voltage withstand test.
- AC voltage is instantaneous voltage for V_{TH+} & V_{TH-} .
- All typicals at $T_A = 25^\circ\text{C}$, $V_{CC} = 5\text{V}$ unless otherwise specified.

Typical Performance Curves

Fig. 1 Logic Low Supply Current vs. Operating Supply Voltage

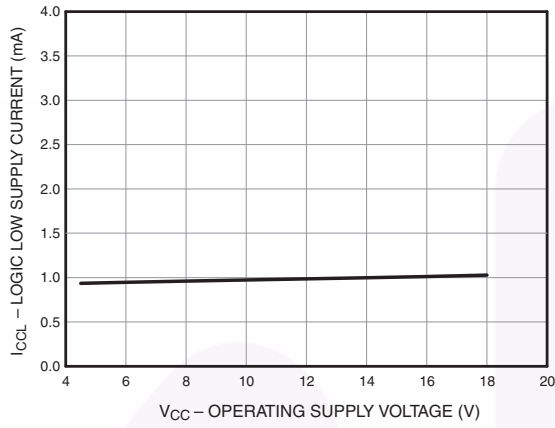

Fig. 2 Input Current vs. Input Voltage

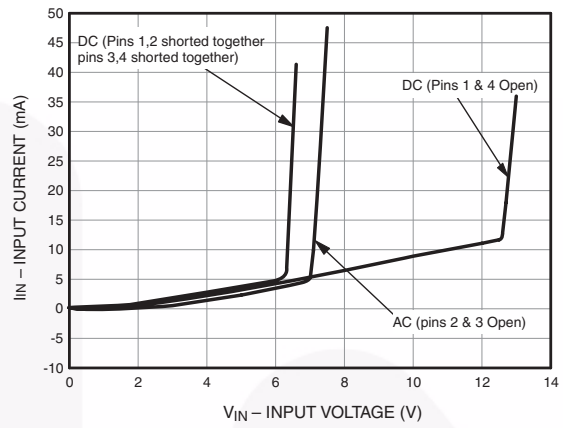

Fig. 3 Input Current/Low Level Output Voltage vs. Temperature

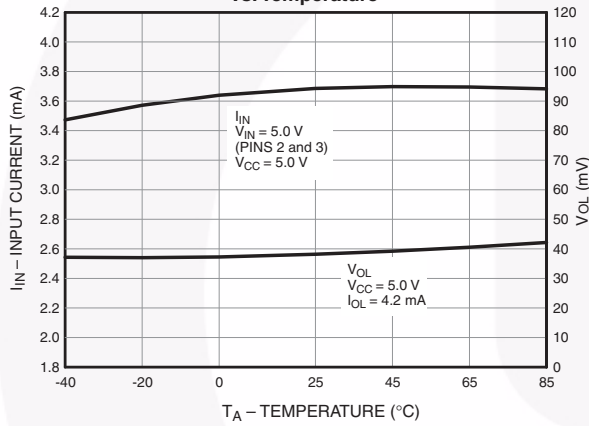

Fig. 4 Current Threshold/Voltage Threshold vs. Temperature

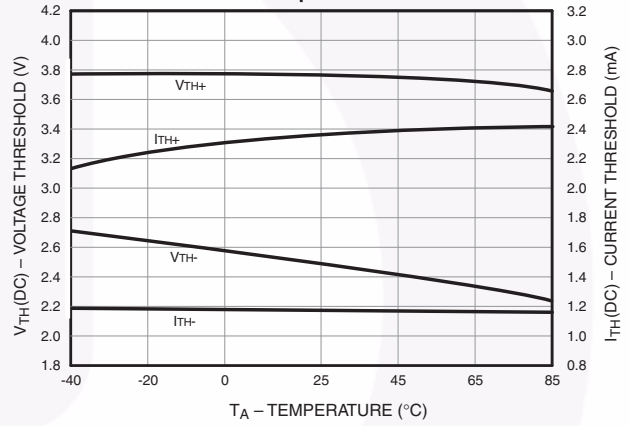

Fig. 5 Propagation Delay vs. Temperature

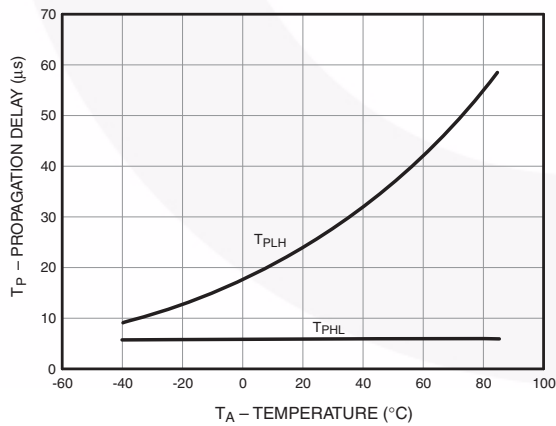
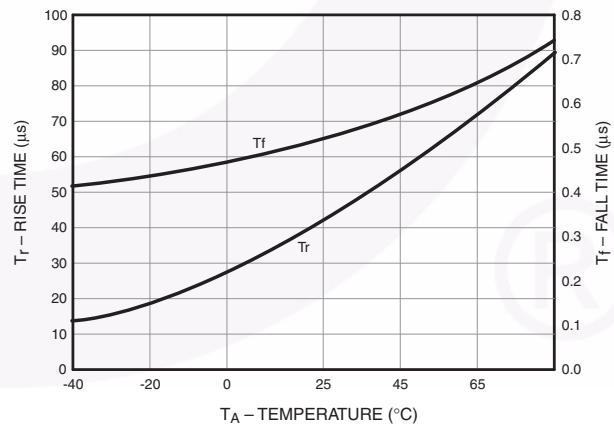

Fig. 6 Rise and Fall Time vs. Temperature



Typical Performance Curves (Continued)

Fig. 7 Logic High Supply Current vs. Temperature

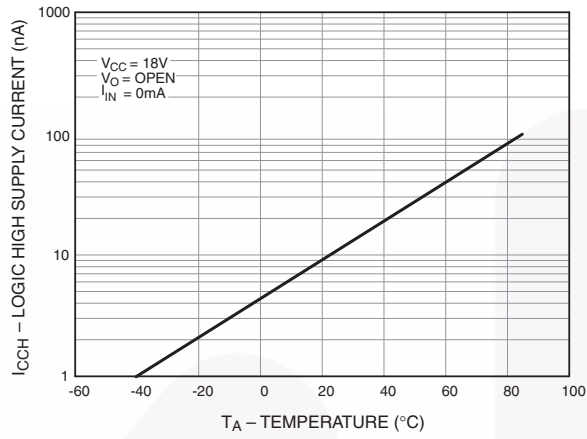
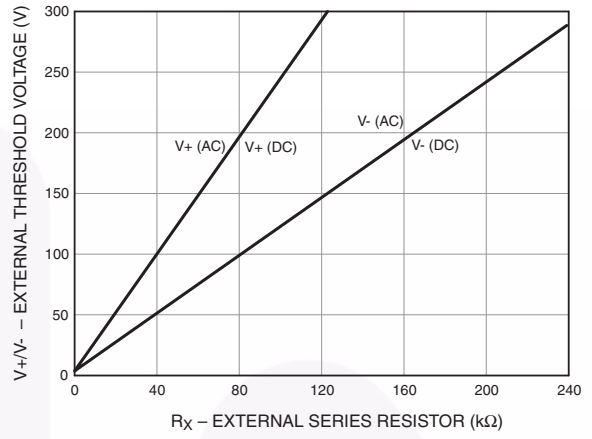
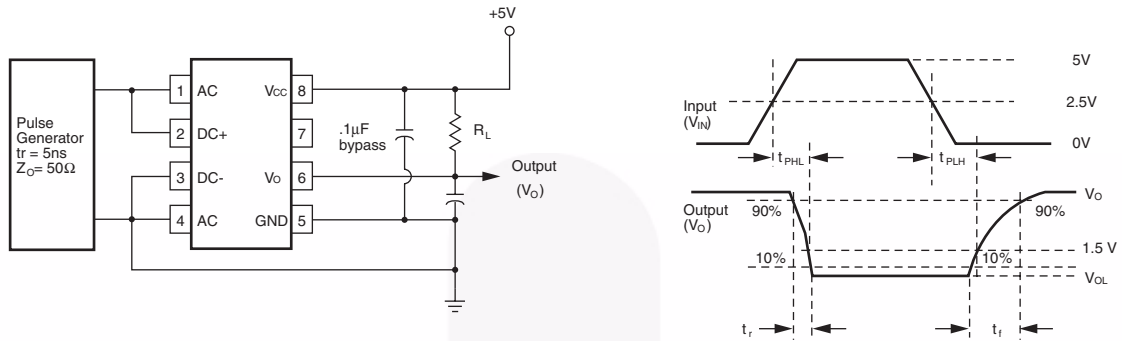

Fig. 8 External Threshold Characteristics V+/V- vs. R_x



Test Circuits



V_{IN}
 Pulse Amplitude = 50V
 Pulse Width = 1ms
 f = 100Hz
 $T_r = T_f = 1.0\mu s$ (10%–90%)

Fig. 9. Switching Test Circuit

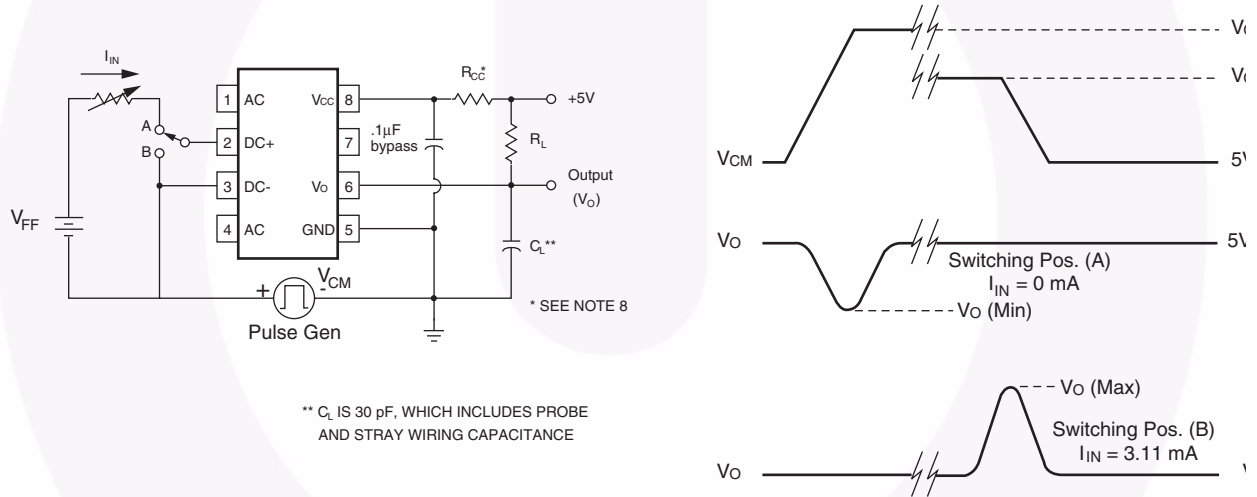

Fig. 10. Test Circuit for Common Mode Transient Immunity and Typical Waveforms

** C_L IS 30 pF, WHICH INCLUDES PROBE AND STRAY WIRING CAPACITANCE

* SEE NOTE 8

Ordering Information

Option	Example Part Number	Description
No Suffix	HCPL3700	Shipped in Tubes
S	HCPL3700S	Surface Mount Lead Bend
SD	HCPL3700SD	Surface Mount; Tape and Reel
W	HCPL3700W	0.4" Lead Spacing
V	HCPL3700V	VDE0884
WV	HCPL3700WV	VDE0884; 0.4" Lead Spacing
SV	HCPL3700SV	VDE0884; Surface Mount
SDV	HCPL3700SDV	VDE0884; Surface Mount; Tape and Reel

Marking Information

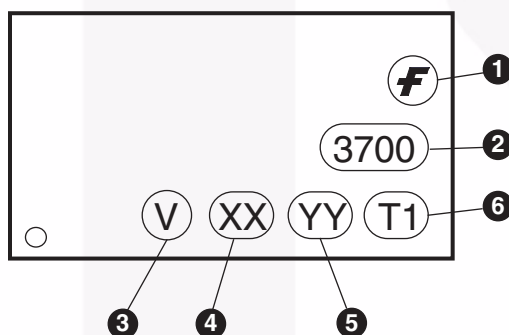

Definitions	
1	Fairchild logo
2	Device number
3	VDE mark (Note: Only appears on parts ordered with VDE option – See order entry table)
4	Two digit year code, e.g., '07'
5	Two digit work week ranging from '01' to '53'
6	Assembly package code

Carrier Tape Specifications

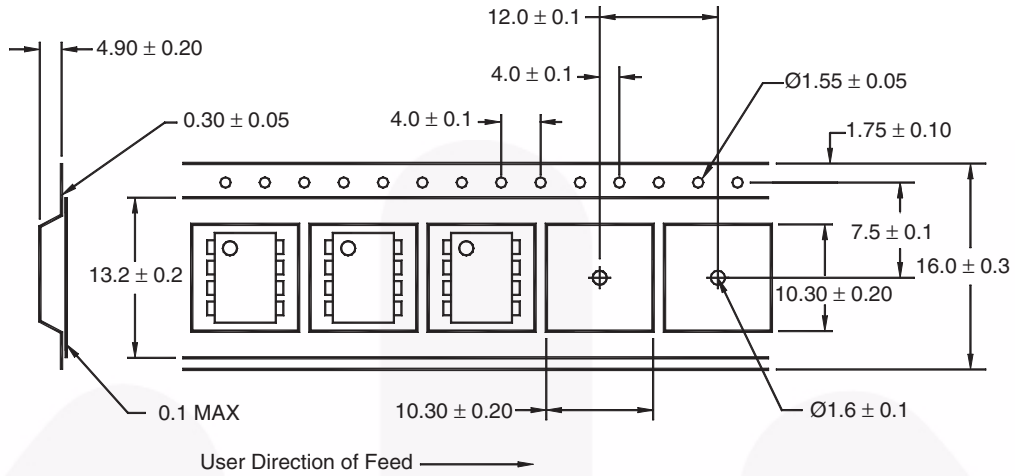

Note:
All dimensions are in inches (millimeters)

Reflow Profile

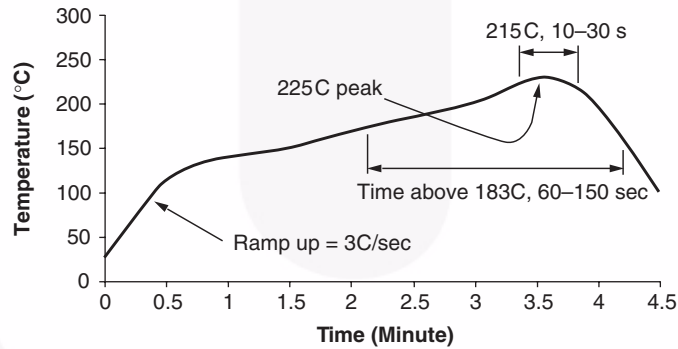

- Peak reflow temperature: 225C (package surface temperature)
- Time of temperature higher than 183C for 60–150 seconds
- One time soldering reflow is recommended



- NOTES:
- A) NO STANDARD APPLIES TO THIS PACKAGE
 - B) ALL DIMENSIONS ARE IN MILLIMETERS.
 - C) DIMENSIONS ARE EXCLUSIVE OF BURRS, MOLD FLASH, AND TIE BAR EXTRUSION
 - D) DRAWING FILENAME AND REVISION: MKT-N08GREV7





LAND PATTERN RECOMMENDATION

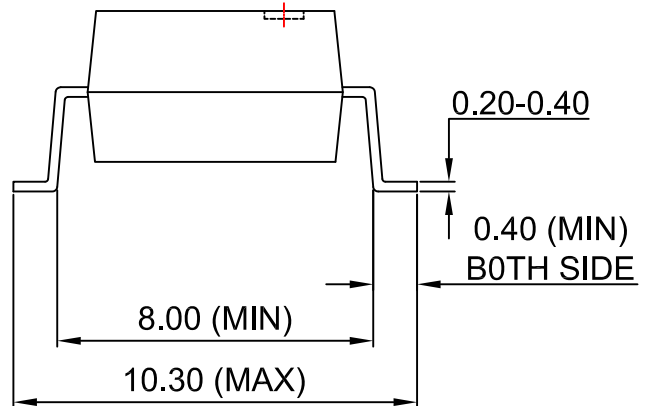

NOTES:

- A) NO STANDARD APPLIES TO THIS PACKAGE
- B) ALL DIMENSIONS ARE IN MILLIMETERS.
- C) DIMENSIONS ARE EXCLUSIVE OF BURRS, MOLD FLASH, AND TIE BAR EXTRUSION
- D) DRAWING FILENAME AND REVISION: MKT-N08Hrev7.





TRADEMARKS

The following includes registered and unregistered trademarks and service marks, owned by Fairchild Semiconductor and/or its global subsidiaries, and is not intended to be an exhaustive list of all such trademarks.

AccuPower™
AttitudeEngine™
Awinda®
AX-CAP®*
BitSiC™
Build it Now™
CorePLUS™
CorePOWER™
CROSSVOL™
CTL™
Current Transfer Logic™
DEUXPEED®
Dual Cool™
EcoSPARK®
EfficientMax™
ESBC™
F®
Fairchild®
Fairchild Semiconductor®
FACT Quiet Series™
FACT®
FastvCore™
FETBench™
FPS™

F-PFS™
FRFET®
Global Power Resource™
GreenBridge™
Green FPS™
Green FPS™ e-Series™
Gmax™
GTO™
IntelliMAX™
ISOPLANAR™
Making Small Speakers Sound Louder and Better™
MegaBuck™
MICROCOUPLER™
MicroFET™
MicroPak™
MicroPak2™
MillerDrive™
MotionMax™
MotionGrid®
MTi®
MTx®
MVN®
mWSaver®
OptoHiT™
OPTOLOGIC®

OPTOPLANAR®
Power Supply WebDesigner™
PowerTrench®
PowerXS™
Programmable Active Droop™
QFET®
QS™
Quiet Series™
RapidConfigure™
Saving our world, 1mW/W/kW at a time™
SignalWise™
SmartMax™
SMART START™
Solutions for Your Success™
SPM®
STEALTH™
SuperFET®
SuperSOT™-3
SuperSOT™-6
SuperSOT™-8
SupreMOS®
SyncFET™
Sync-Lock™

SYSTEM GENERAL®
TinyBoost®
TinyBuck®
TinyCalc™
TinyLogic®
TINYOPTO™
TinyPower™
TinyPWM™
TinyWire™
TranSiC™
TriFault Detect™
TRUECURRENT®*
µSerDes™
SerDes®
UHC®
Ultra FRFET™
UniFET™
VCX™
VisualMax™
VoltagePlus™
XS™
Xsens™
仙童®

* Trademarks of System General Corporation, used under license by Fairchild Semiconductor.

DISCLAIMER

FAIRCHILD SEMICONDUCTOR RESERVES THE RIGHT TO MAKE CHANGES WITHOUT FURTHER NOTICE TO ANY PRODUCTS HEREIN TO IMPROVE RELIABILITY, FUNCTION, OR DESIGN. TO OBTAIN THE LATEST, MOST UP-TO-DATE DATASHEET AND PRODUCT INFORMATION, VISIT OUR WEBSITE AT [HTTP://WWW.FAIRCHILDSEMI.COM](http://www.fairchildsemi.com). FAIRCHILD DOES NOT ASSUME ANY LIABILITY ARISING OUT OF THE APPLICATION OR USE OF ANY PRODUCT OR CIRCUIT DESCRIBED HEREIN; NEITHER DOES IT CONVEY ANY LICENSE UNDER ITS PATENT RIGHTS, NOR THE RIGHTS OF OTHERS. THESE SPECIFICATIONS DO NOT EXPAND THE TERMS OF FAIRCHILD'S WORLDWIDE TERMS AND CONDITIONS, SPECIFICALLY THE WARRANTY THEREIN, WHICH COVERS THESE PRODUCTS.

AUTHORIZED USE

Unless otherwise specified in this data sheet, this product is a standard commercial product and is not intended for use in applications that require extraordinary levels of quality and reliability. This product may not be used in the following applications, unless specifically approved in writing by a Fairchild officer: (1) automotive or other transportation, (2) military/aerospace, (3) any safety critical application – including life critical medical equipment – where the failure of the Fairchild product reasonably would be expected to result in personal injury, death or property damage. Customer's use of this product is subject to agreement of this Authorized Use policy. In the event of an unauthorized use of Fairchild's product, Fairchild accepts no liability in the event of product failure. In other respects, this product shall be subject to Fairchild's Worldwide Terms and Conditions of Sale, unless a separate agreement has been signed by both Parties.

ANTI-COUNTERFEITING POLICY

Fairchild Semiconductor Corporation's Anti-Counterfeiting Policy. Fairchild's Anti-Counterfeiting Policy is also stated on our external website, www.fairchildsemi.com, under Terms of Use

Counterfeiting of semiconductor parts is a growing problem in the industry. All manufacturers of semiconductor products are experiencing counterfeiting of their parts. Customers who inadvertently purchase counterfeit parts experience many problems such as loss of brand reputation, substandard performance, failed applications, and increased cost of production and manufacturing delays. Fairchild is taking strong measures to protect ourselves and our customers from the proliferation of counterfeit parts. Fairchild strongly encourages customers to purchase Fairchild parts either directly from Fairchild or from Authorized Fairchild Distributors who are listed by country on our web page cited above. Products customers buy either from Fairchild directly or from Authorized Fairchild Distributors are genuine parts, have full traceability, meet Fairchild's quality standards for handling and storage and provide access to Fairchild's full range of up-to-date technical and product information. Fairchild and our Authorized Distributors will stand behind all warranties and will appropriately address any warranty issues that may arise. Fairchild will not provide any warranty coverage or other assistance for parts bought from Unauthorized Sources. Fairchild is committed to combat this global problem and encourage our customers to do their part in stopping this practice by buying direct or from authorized distributors.

PRODUCT STATUS DEFINITIONS

Definition of Terms

Datasheet Identification	Product Status	Definition
Advance Information	Formative / In Design	Datasheet contains the design specifications for product development. Specifications may change in any manner without notice.
Preliminary	First Production	Datasheet contains preliminary data; supplementary data will be published at a later date. Fairchild Semiconductor reserves the right to make changes at any time without notice to improve design.
No Identification Needed	Full Production	Datasheet contains final specifications. Fairchild Semiconductor reserves the right to make changes at any time without notice to improve the design.
Obsolete	Not In Production	Datasheet contains specifications on a product that is discontinued by Fairchild Semiconductor. The datasheet is for reference information only.