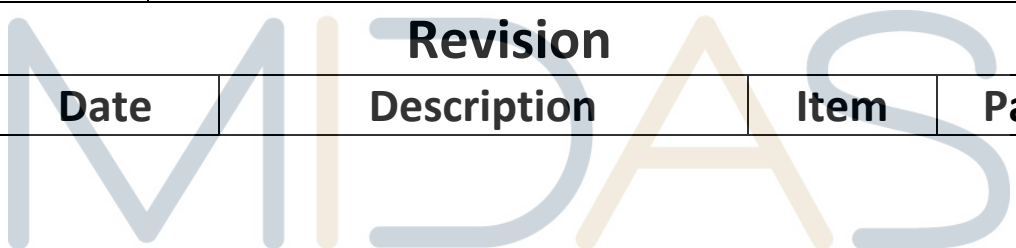

<b>Specification</b>				
<b>Part Number:</b>		<b>MC240064A6W-FPTLW</b>		
<b>Version:</b>				
<b>Date:</b>				
<b>Revision</b>				
<b>No.</b>	<b>Date</b>	<b>Description</b>	<b>Item</b>	<b>Page</b>
				

## BOOKBINDING AREA

DOC.

DATASHEET STATEMENT

1. The following icons are absolutely designed by Midas independently in 2007-SEP. They are not in common use in the LCD industry yet but just used for marking out Midas products' characteristics quickly and simply without any special meaning. Midas reserves the composing right and copyright. No one else is allowed to adopt these icons without Midas approval.
2. The ISO9001 logo used in this document is authorized by SGS ([www.sgs.com](http://www.sgs.com)). Midas had already successfully passed the strict and professional ISO9001:2000 Quality Management System Certification and got the certificate (No.: CN07/00404)
3. The technologies/techniques/crafts which denoted by the following icons are not exclusively owned by Midas, but also shared by Midas LCD strategic cooperators, however all these technologies/techniques/crafts have been finally confirmed by Midas professional engineers and QC department.
4. As the difference in test standard and test conditions, also Midas insufficient familiarity with the actual LCD using environment, all the referred information in this DATASHEET (including the icons) only have two functions:  
4.1: providing quick reference when you are judging whether or not the product meets your requirements.  
4.2: listing out definitely the tolerance.

SAMPLE APPROVAL document rather than consider this DATASHEET as the standard for judging whether or not the LCD meets your requirements. Once you instruct Midas to a mass-production without definite demand for providing sample before, Midas will disclaim all responsibility if the mass-production is proved not meeting with your requirements.

5. The sequence of the icons is random and doesn't indicate the importance grade.
6. Icons explanation

Midas 2006 version logo. Midas is an integrated manufacturer of flat panel display (FPD). Midas supplies TN, HTN, STN, FSTN monochrome LCD panel; COB, COG, TAB LCD module; and all kinds of LED backlight.



### FAST RESPONSE TIME

This icon on the cover indicates the product is with high response speed; Otherwise not.



### PROTECTION CIRCUIT

This icon on the cover indicates the product is with protection circuit; Otherwise not.



### HIGH CONTRAST

This icon on the cover indicates the product is with high contrast; Otherwise not.



### LONG LIFE VERSION

This icon on the cover indicates the product is long life version (over 9K hours guaranteed); Otherwise not.



### WIDE VIEWING SCOPE

This icon on the cover indicates the product is with wide viewing scope; Otherwise not.



### Anti UV VERSION

This icon on the cover indicates the product is against UV line. Otherwise not.



### RoHS COMPLIANCE

This icon on the cover indicates the product meets ROHS requirements; Otherwise not.



### OPERATION TEMPERATURE RANGE

This icon on the cover indicates the operating temperature range (X-Y).



### 3TIMES 100% QC EXAMINATION

This icon on the cover indicates the product has passed Midas thrice 100% QC. Otherwise not.



### TWICE SELECTION OF LED MATERIALS

This icon on the cover indicates the LED had passed Midas twice strict selection which promises the product's identical color and brightness; Otherwise not.



### V1cm = 3.0V

This icon on the cover indicates the product can work at 3.0V exactly; otherwise not.



### N SERIES TECHNOLOGY (2008 developed)

New structure, new craft, new technology and new materials inside both LCD module and LCD panel to improve the "RainBow"

# Midas LCD Part Number System

**MC COG 132033 A \* 6 W \* \* - S N T L W \* \***  
**1 2 3 4 5 6 7 8 9 - 10 11 12 13 14 15 16**

- 1 = **MC:** Midas Components
- 2 = **Blank:** COB (chip on board) **COG:** chip on glass
- 3 = **No of dots** (e.g. 240064 = 240 x 64 dots) (e.g. 21605 = 2 x 16 5mm C.H.)
- 4 = **Series**
- 5 = **Series Variant:** A to Z – see addendum
- 6 = **3:** 3 o'clock **6:** 6 o'clock **9:** 9 o'clock **12:** 12 o'clock
- 7 = **S:** Normal (0 to + 50 deg C) **W:** Wide temp. (-20 to + 70 deg C) **X:** Extended temp (-30 + 80 Deg C)
- 8 = **Character Set**

**Blank:** Standard (English/Japanese)  
**C:** Chinese Simplified (Graphic Displays only)  
**CB:** Chinese Big 5 (Graphic Displays only)  
**H:** Hebrew  
**K:** European (std) (English/German/French/Greek)  
**L:** English/Japanese (special)  
**M:** European (English/Scandinavian)  
**R:** Cyrillic  
**W:** European (English/Greek)  
**U:** European (English/Scandinavian/Icelandic)

9 = **Bezel Height** (where applicable /available)

	Top of Bezel to Top of PCB	LED Connection Common (via pins 1 and 2) via pins 15+ 16-	Array or Edge Lit
<b>Blank</b>	9.5mm / not applicable	Common	Array
<b>2</b>	8.9 mm	Common	Array
<b>3</b>	7.8 mm	Separate	Array
<b>4</b>	7.8 mm	Common	Array
<b>5</b>	9.5 mm	Separate	Array
<b>6</b>	7 mm	Common	Array
<b>7</b>	7 mm	Separate	Array
<b>8</b>	6.4 mm	Common	Edge
<b>9</b>	6.4 mm	Separate	Edge
<b>A</b>	5.5 mm	Common	Edge
<b>B</b>	5.5 mm	Separate	Edge
<b>D</b>	6.0mm	Separate	Edge
<b>E</b>	5.0mm	Separate	Edge
<b>F</b>	4.7mm	Common	Edge
<b>G</b>	3.7mm	Separate	EL
<b>H</b>	7 mm	Separate	Edge

- 10 = **T:** TN **S:** STN **B:** STN Blue **G:** STN Grey **F:** FSTN **F2:** FFSTN **V:** VA (Vertically Aligned)
- 11 = **P:** Positive **N:** Negative
- 12 = **R:** Reflective **M:** Transmissive **T:** Transflective
- 13 = **Backlight:** **Blank:** Reflective **L:** LED
- 14 = **Backlight Colour:** **Y:** Yellow-Green **W:** White **B:** Blue **R:** Red **A:** Amber **O:** Orange **G:** Green **RGB:** R.G.B.
- 15 = **Driver Chip:** **Blank:** Standard **I:** I<sup>2</sup>C **S:** SPI **T:** Toshiba T6963C **A:** Avant SAP1024B **R:** Raio RA6963
- 16 = **Voltage Variant:** e.g. **3** = 3v

BOOKBINDING AREA

	STANDARD DOC.	CONTENTS	PAGE	3/21
--	------------------	----------	------	------

1. GENERAL SPECIFICATIONS -----	Page 4
2. MECHANICAL SPECIFICATIONS -----	Page 4
3. ABSOLUTE MAXIMUM RATINGS -----	Page 4
4. ELECTRONICAL CHARACTERISTIC -----	Page 4
5. OPTICAL CHARACTERISTICS -----	Page 5
6. AC CHARACTERISTICS -----	Page 6
7. EXTERNAL DIMENSION-----	Page 7
8. PIN ASSIGNMENT -----	Page 8
9. BLOCK DIAGRAM -----	Page 8
10. POWER SUPPLY -----	Page 8
11. FLOWCHART OF COMMUNICATIONS WITH MPU -----	Page 9
12. COMMAND DEFINITIONS -----	Page 10
13. DESCRIPTION OF COMMAND-----	Page 11
14. CHARACTER MAP -----	Page 20
15. PACKING DETAIL -----	Page 21

**BOOKBINDING AREA**

	<b>PRODUCT SPEC.</b>	<b>MODE NO.</b>	<b>PAGE</b>	<b>4/21</b>
		MC240064A6W-FPTLW		

**1. GENERAL SPECIFICATIONS**

ITEM	NOMINAL DIMENSIONS / AVAILABLE OPTIONS
DISPLAY FORMAT	240 X 64 DOT MATRIX
LCD PANEL OPTIONS	FSTN (Silver-Gray color)
POLARIZER OPTIONS	Positive, Transflective
BACKLIGHT OPTIONS	Edge type LED backlight (White Color)
VIEWING ANGLE OPTIONS	6:00 ( Bottom )
TEMPERATURE RANGE OPTIONS	Wide temperature range ( -20°C ~ 70°C )
CONTROLLER IC	AVANT (SAP1024B)+NT7086
NEGATIVE IC	Build In
DISPLAY DUTY	1/64
DRIVING BIAS	1/ 9

**2. MECHANICAL SPECIFICATIONS**

<b>OVERALL SIZE</b>	LED backlight version : 180.0 x 65.0 x max 13.0				mm
<b>VIEWING AREA</b>	132.0W x 39.0H	mm	<b>HOLE-HOLE</b>	176.0W x 54.0H	mm
<b>DOT SIZE</b>	0.49W x 0.49H	mm	<b>DOT PITCH</b>	0.04W x 0.04H	mm
<b>WEIGHT (LED BKL)</b>	120.0	g	<b>WEIGHT (EL BKL)</b>	100.0	g

**3. ABSOLUTE MAXIMUM RATINGS**

ITEM	SYMBOL	CONDITION	MIN	MAX	UNIT
POWER SUPPLY ( LOGIC)	Vdd	25°C	-0.3	7.0	V
POWER SUPPLY (LCD)	V0	25°C	Vdd -30.0	Vdd +0.3	V
INPUT VOLTAGE	Vin	25°C	-0.3	Vdd +0.3	V
OPERATING TEMPERATURE	Vopr	—	-20	70	°C
STORAGE TEMPERATURE	Vstg	—	-30	80	°C

**4. ELECTRONICAL CHARACTERISTIC\***

ITEM	SYMBOL	CONDITION	STANDARD			UNIT
			MIN	TYP	MAX	
Input voltage	Vdd	+5V	4.7	5.0	5.5	V
Supply current	Idd	Vdd=5V	—	2.5	—	mA
Recommended LCD driving voltage for normal temp. Version module	Vdd - V0	-20°C	11.70	—	12.10	V
		0°C	11.45	—	11.95	
		25°C	11.40	—	11.90	
		50°C	11.00	—	11.50	
		70°C	10.40	—	11.10	
LED forward voltage	Vf	25°C	2.9	—	3.4	V
LED forward current	If	25°C	—	60	80	mA
LED reverse Current	Ir	25°C	—	40	—	µA
LED color range	X coordinate	25°C If = 60mA	0.25	—	0.28	—
	Y coordinate	25°C If = 60mA	0.26	—	0.29	—
LED illuminance (Without LCD)	Lv	25°C If = 60mA	160	—	210	cd/m <sup>2</sup>
LED life time	—	25°C If = 60mA	50K**	—	—	Hours

5. OPTICAL CHARACTERISTICS

FOR TN TYPE LCD MODULE (TA=25 °C, Vdd=5.0V ± 0.25V)						
ITEM	SYMBOL	CONDITION	MIN	TYP	MAX	UNIT
VIEWING ANGLE	$\phi 2 - \phi 1$	K=4	30	---	---	deg
	$\theta$		25			
CONTRAST RATIO	K	---	---	2	---	---
RESPONSE TIME(RISE)	TR	---	---	120	150	ms
RESPONSE TIME(FALL)	TF	---	---	120	150	ms

FOR STN TYPE LCD MODULE (TA=25 °C, Vdd=5.0V ± 0.25V)						
ITEM	SYMBOL	CONDITION	MIN	TYP	MAX	UNIT
VIEWING ANGLE	$\phi 2 - \phi 1$	K=4	40	---	---	deg
	$\theta$		60			
CONTRAST RATIO	K	---	---	6	---	---
RESPONSE TIME(RISE)	TR	---	---	150	250	ms
RESPONSE TIME(FALL)	TF	---	---	150	250	ms

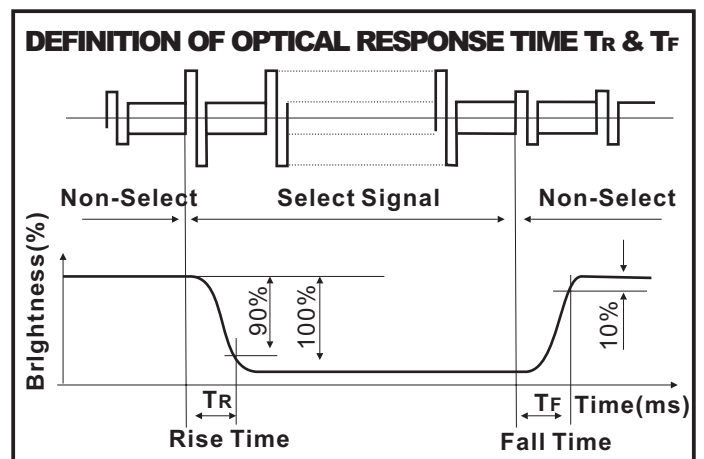
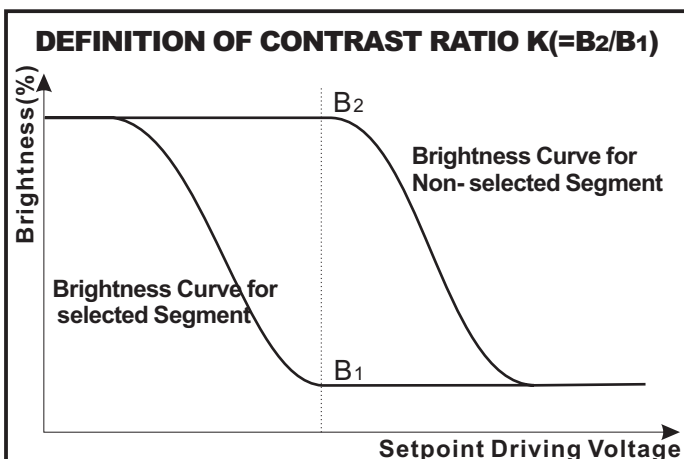
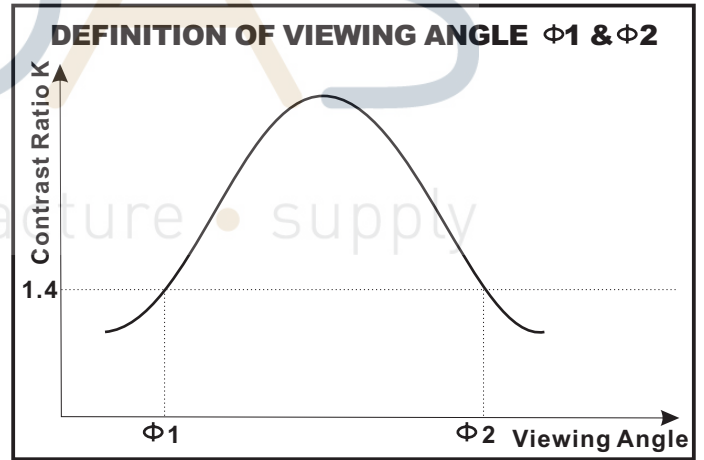
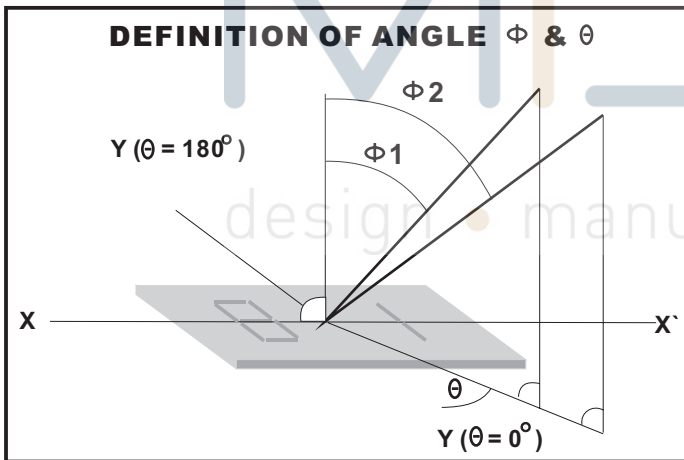

	PRODUCT SPEC.	MODE NO.	PAGE	6/21
		MC240064A6W-FPTLW		

6.AC CHARACTERISTIC

ITEM	SYMBOL	MIN	MAX	UNIT
C/D Set-up Time	$t_{CDS}$	100	---	ns
C/D Hold Time	$t_{CDH}$	10	---	ns
$\overline{CE}$ , $\overline{RD}$ , $\overline{WR}$ Pulse Width	$t_{CE}$ , $t_{RD}$ , $t_{WR}$	80	---	ns
Data Set-up Time	$t_{DS}$	80	---	ns
Data Hold Time	$t_{DH}$	40	---	ns
Access Time	$t_{ACC}$	---	150	ns
Output Hold Time	$t_{OH}$	10	50	ns

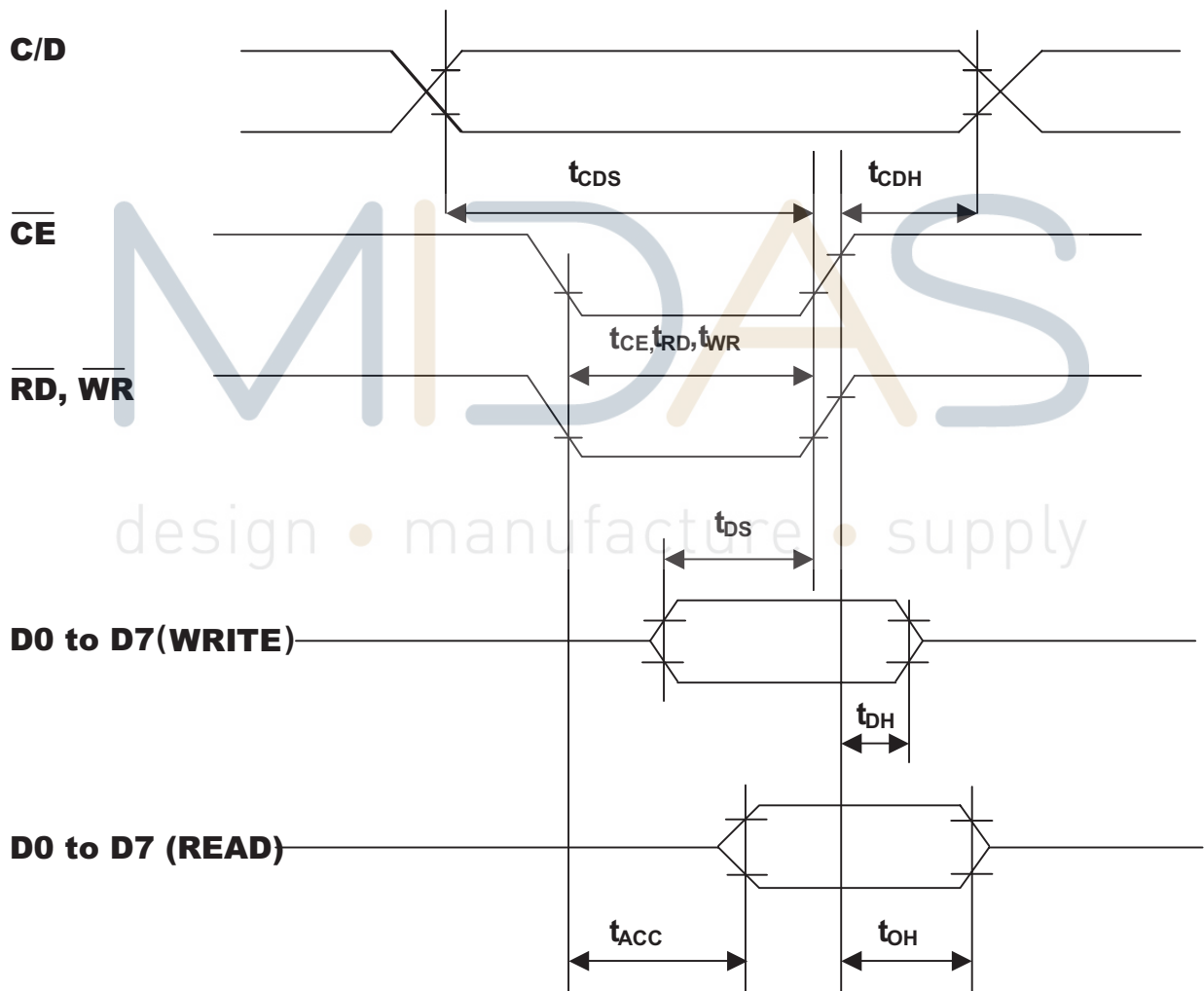

TEST CONDITIONS (Unless otherwise noted,  $V_{DD}=5.0V \pm 10\%$ ,  $V_{SS}=0V$ ,  $T_a=-20^\circ C$  to  $75^\circ C$ )

7.EXTERNAL DIMENSIONS

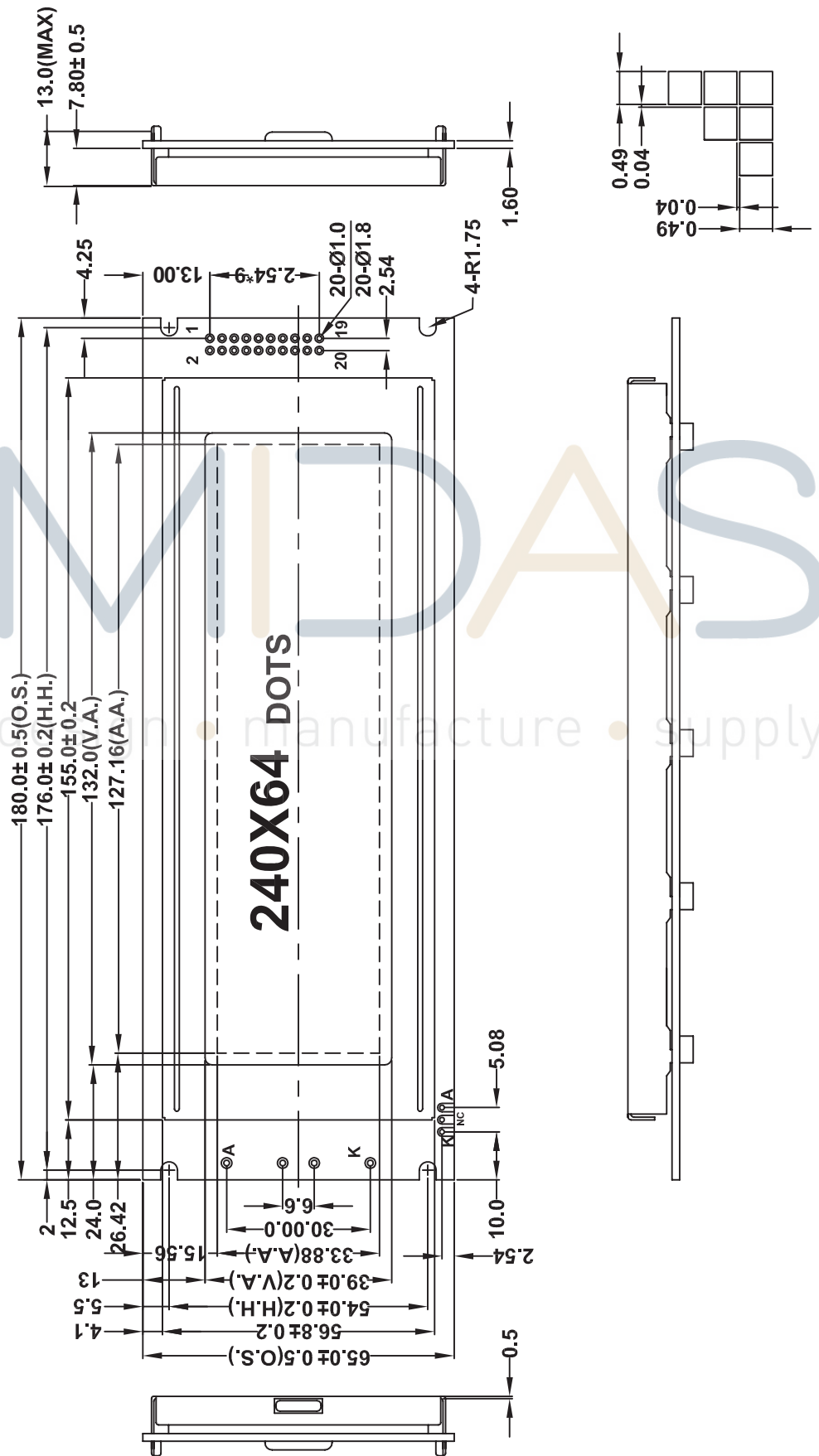



**8. PIN ASSIGNMENT**

PIN NO.	SYMBOL	FUNCTION	REMARK
1	FG	Module Frame Ground	
2	Vss	Power Supply	0V
3	Vdd		+5V
4	V0		Contrast adjustment
5	WR	Data Write	
6	RD	Data Read	
7	CE	Chip Enable	
8	C/D	Command/Data Select	
9	Vee	Operating voltage for LCD	
10	RST	Reset Signal	
11	DB0	Data Bit 0	
12	DB1	Data Bit 1	
13	DB2	Data Bit 2	
14	DB3	Data Bit 3	
15	DB4	Data Bit 4	
16	DB5	Data Bit 5	
17	DB6	Data Bit 6	
18	DB7	Data Bit 7	
19	FS	Font Selection	
20	NC	No connection	
A	LED+	Anode of LED Unit	+5.0V
K	LED-	Cathode of LED Unit	0V

**9. BLOCK DIAGRAM**

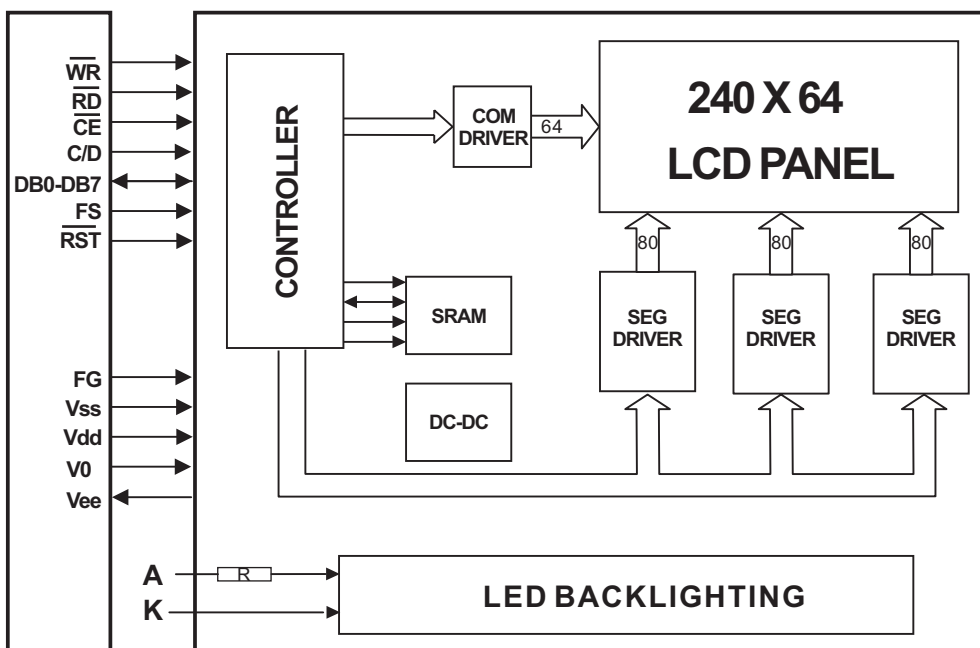

**10. POWER SUPPLY**

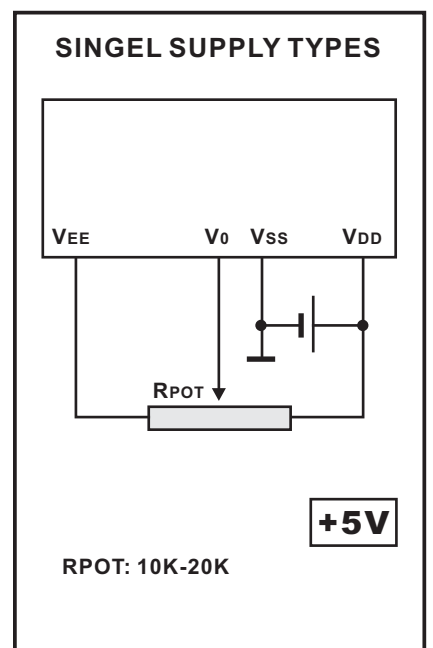

	<b>PRODUCT SPEC.</b>	<b>MODE NO.</b>	<b>PAGE</b>	<b>9/21</b>
		MC240064A6W-FPTLW		

**11. FLOWCHART OF COMMUNICATIONS WITH MPU**

**Status Word**

MSB

LSB

<b>STA7</b> D7	<b>STA6</b> D6	<b>STA5</b> D5	<b>STA4</b> D4	<b>STA3</b> D3	<b>STA2</b> D2	<b>STA1</b> D1	<b>STA0</b> D0
-------------------	-------------------	-------------------	-------------------	-------------------	-------------------	-------------------	-------------------

<b>STA0</b>	<b>Check command execution capability</b>	<b>0:Disable 1:Enable</b>
<b>STA1</b>	<b>Check data read / write capability</b>	<b>0:Disable 1:Enable</b>
<b>STA2</b>	<b>Check auto mode data read capability</b>	<b>0:Disable 1:Enable</b>
<b>STA3</b>	<b>Check auto mode data write capability</b>	<b>0:Disable 1:Enable</b>
<b>STA4</b>	<b>Not used</b>	
<b>STA5</b>	<b>Check controller operation capability</b>	<b>0:Disable 1:Enable</b>
<b>STA6</b>	<b>Error flag. Used for Screen Peek and Screen copy commands</b>	<b>0:No error 1:Error</b>
<b>STA7</b>	<b>Check the blink condition</b>	<b>0:Dsiplayoff 1:Normal display</b>

Note 1 : A status check must be performed before data is read or written.

Note 2 : It is necessary to check STA0 and STA1 at the same time.

There is a possibility of erroneous operation due to a hardware interrupt .

Note 3 : For most modes STA0 / STA1 are used as a status check.

Note 4 : STA2 and STA3 are valid in Auto mode; STA0 and STA1 are invalid.

**Setting Data**

A) The case of 1 data

B) The case of 2 data

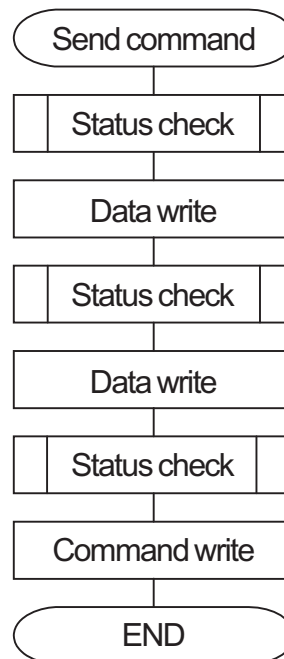
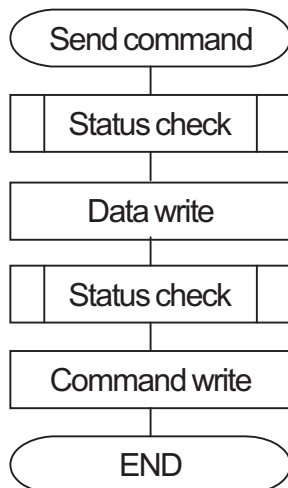

**BOOKBINDING AREA**

	<b>PRODUCT SPEC.</b>	<b>MODE NO.</b>	<b>PAGE</b>	<b>10/21</b>
		MC240064A6W-FPTLW		

**12. COMMAND DEFINITIONS**

COMMAND	CODE	D1	D2	FUNCTION
REGISTERS SETTING	00100 0 0 1 00100 0 1 0 00100 1 0 0	X address Data Low address	Y address 00H High address	Set Cursor Pointer Set Offset Register Set Address Pointer
SET CONTROL WORD	01000 0 0 0 01000 0 0 1 01000 0 1 0 01000 0 1 1	Low address Columns Low address Columns	High address 00H High address 00H	Set Text Home Address Set Text Area Set Graphic Home Address Set Graphic Area
MODE SET	1000X 0 0 0 1000X 0 0 1 1000X 0 1 1 1000X 1 0 0 10000 XXX 10001 XXX	---	---	OR mode EXOR mode AND mode Text Attribute mode Internal CG ROM mode External CG RAM mode
DISPLAY MODE	10010 0 0 0 1001XX 1 0 1001XX 1 1 10010 1 XX 10011 0 XX 10011 1 XX	---	---	Display off Cursor on, blink off Cursor on, blink on Text on, graphic off Text off, graphic on Text on, graphic on
CURSOR PATTERN SELECT	10100 0 0 0 10100 0 0 1 10100 0 1 0 10100 0 1 1 10100 1 0 0 10100 1 0 1 10100 1 1 0 10100 1 1 1	---	---	1-line cursor 2-line cursor 3-line cursor 4-line cursor 5-line cursor 6-line cursor 7-line cursor 8-line cursor
DATA AUTO READ/WRITE	10110 0 0 0 10110 0 0 1 10110 0 1 0	---	---	Set Data Auto Write Set Data Auto Read Auto Reset
DATA READ/WRITE	11000 0 0 0 11000 0 0 1 11000 0 1 0 11000 0 1 1 11000 1 0 0 11000 1 0 1	Data --- Data --- Data ---	---	Data Write and Increment ADP Data Read and Increment ADP Data Write and Decrement ADP Data Read and Decrement ADP Data Write and Non-variable ADP Data Read and Non-variable ADP
SCREEN PEEK	11100 0 0 0	---	---	Screen Peek
SCREEN COPY	11101 0 0 0	---	---	Screen Copy
BIT SET/RESET	11110 XXX 11111 XXX 1111X 0 0 0 1111X 0 0 1 1111X 0 1 0 1111X 0 1 1 1111X 1 0 0 1111X 1 0 1 1111X 1 1 0 1111X 1 1 1	---	---	Bit Reset Bit Set Bit 0 (LSB) Bit1 Bit2 Bit3 Bit4 Bit5 Bit6 Bit 7 (MSB)

Note: First set the data, then set the command.

	<b>PRODUCT SPEC.</b>	<b>MODE NO.</b>	<b>PAGE</b>	<b>11/21</b>
		MC240064A6W-FPTLW		

### 13. Description of Command

#### Setting Registers

##### (1) Set Cursor Pointer

The position of the cursor is specified by X ADRS and Y ADRS. The cursor position can only be moved by this command . Data read / write from the MPU never changes the cursor pointer

X ADRS: 00H to 4FH(lower 7 bits are valid); Y ADRS: 00H to 1FH (lower 5 bits are valid)

a ) Single-Scan

X ADRS 00 to 4FH

Y ADRS 00H to 0FH

b ) Dual-Scan

X ADRS 00H to 4FH

Y ADRS 00H to 0FH  
Upper screen

Y ADRS 10H to 1FH  
Lower screen

##### (2) Set Offset Register

The offset register is used to determine the external character generator RAM are.

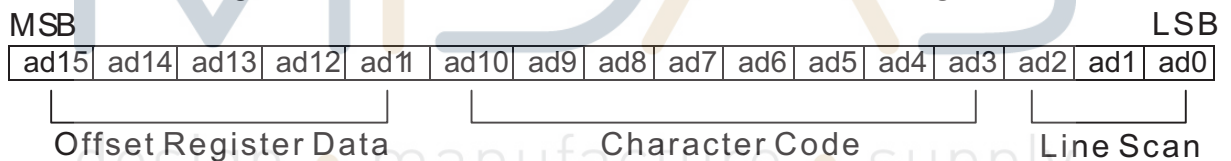

The senior five bits define the start address in external memory of the CG RAM area. The next eight bits represent the character code of the character. In internal CG ROM mode, character codes 00H to 7FH represent the predefined internal CG ROM characters, and codes 80H to FFH represent the users own external characters. In external CG RAM mode, all 256 codes from 00H to FFH can be used to represent the users own characters.

The three least significant bits indicate one of the eight rows of eight dots that define the characters shape.

The relationship between display RAM address and offset register.

Offset register data	CG RAM hex. Address (start to end)
00000	0000to 07FFH
00001	0800to 0FFFH
00010	1000to 17FFH
11100	E000to E7FFH
11101	E800to EFFFH
11110	F000to F7FFH
11111	F800to FFFFH

	<b>PRODUCT SPEC.</b>	<b>MODE NO.</b>	<b>PAGE</b>	<b>12/21</b>
		MC240064A6W-FPTLW		

**Example 1:**

Offset register	02H
Character code	80H
Character Generator RAM start address	0001 0100 0000 0000
	1 4 0 0 H

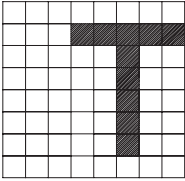
	(address)	(data)
	1400H	00H
	1401H	1FH
	1402H	04H
	1403H	04H
	1404H	04H
	1405H	04H
	1406H	04H
	1407H	00H

**Example 2:**

The relationship between display RAM data and display characters:

	(RAM DATA)	(CHARACTER)
A E Y D E ζ G H U K L M	21H	A
	22H	B
	83H	Y
	24H	D
Display character	25H	E
	86H	ζ

\* Y and ζ are displayed by Character Generator RAM

**(3) SetAddress Pointer**

The SetAddress Pointer command is used to indicate the start address for writing to (or reading from) external RAM.

The flowchart for SetAddress Pointer command:

	<b>PRODUCT SPEC.</b>	<b>MODE NO.</b>	<b>PAGE</b>	<b>13/21</b>
		MC240064A6W-FPTLW		

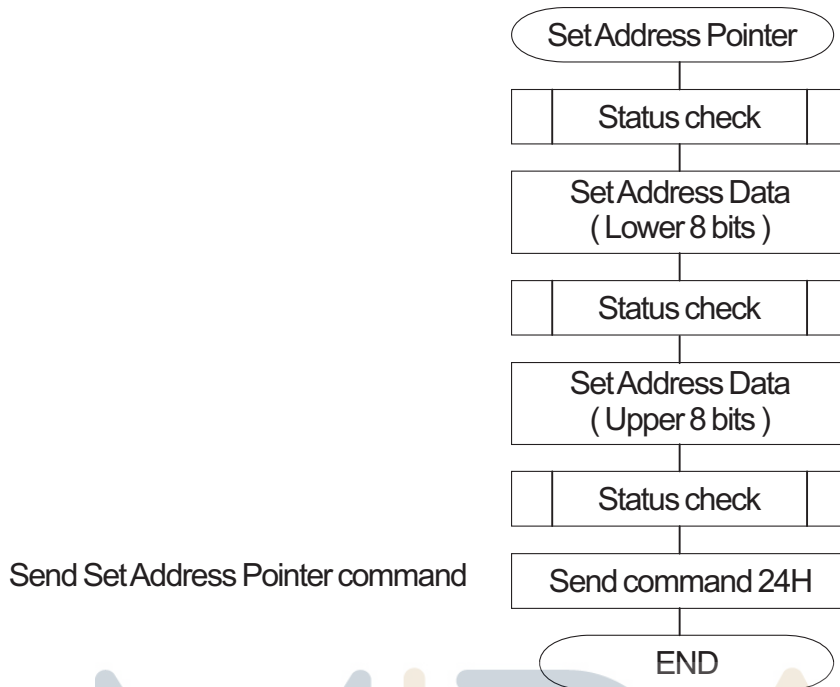

**Set Control Word**

The home address and column size are defined by this command.

**(1) Set Text Home Address**

The starting address in the external display RAM for text display is defined by this command. The text home address indicates the left most and uppermost position. The relationship between external display RAM address and display position.

TH	-----	TH + CL
TH + TA	-----	TH + TA + CL
(TH + TA) + TA	-----	TH + 2TA + CL
-----	-----	-----
TH + (N - 1)TA	-----	TH + (N - 1)TA + CL

TH: Text home address    TA: Text area number (columns)

CL: Columns are fixed by hardware ( pin-programable ).

**Example :**

Text home address: 0000H    Text area: 0020H

MD2 = H, MD3 = H: 32 columns    DUAL = H, MDS = L, MD0 = L, MD1 = H; 4 lines

0000H	0001H	-----	001EH	001FH
0020H	0021H	-----	003EH	003FH
0040H	0041H	-----	005EH	005FH
0060H	0061H	-----	007EH	007FH

	<b>PRODUCT SPEC.</b>	<b>MODE NO.</b>	<b>PAGE</b>	<b>14/21</b>
		MC240064A6W-FPTLW		

**(2) Set Graphic Home Address**

The starting address of the external display RAM used for graphic display is defined by this command. The graphic home address indicates the leftmost and upper most position. The relationship between external display RAM address and display position.

GH	-----	GH + CL
GH + GA	-----	GH + GA + CL
(GH + GA) + GA	-----	GH + 2GA + CL
-----	-----	-----
GH + (N - 1)GA	-----	GH + (N - 1)GA + CL

GH : Graphic home address    GA: Graphic area number (columns)  
 CL : Columns are fixed by hardware (pin-programmable)

**Example**

Graphic home address : 000H    Graphic area : 0020H  
 MD2 = H, MD3 = H;    32 columns    DUAL = H, MDS = L, MD0 = H, MD1 = H;    2lines

0000H	0001H	-----	001EH	001FH
0020H	0021H	-----	003EH	003FH
0040H	0041H	-----	005EH	005FH
0060H	0061H	-----	007EH	007FH
0080H	0081H	-----	009EH	009FH
00A0H	00A1H	-----	00BEH	00BFH
00C0H	00C1H	-----	00DEH	00DFH
00E0H	00E1H	-----	00FEH	00FFH
0100H	0101H	-----	011EH	011FH
0120H	0121H	-----	013EH	013FH
0140H	0141H	-----	015EH	015FH
0160H	0161H	-----	017EH	017FH
0180H	0181H	-----	019EH	019FH
01A0H	01A1H	-----	01BEH	01BFH
01C0H	01C1H	-----	01DEH	01DFH
01E0H	01E1H	-----	01FEH	01FFH

**(3) Set Text Area**

This command can be used to define the columns of the test display.

**Example**

LCD size: 20columns , 4lines    Text home address: 0000H  
 Text area: 0014H    MD2 = H, MD3 = H;    32 columns  
 DUAL = H, MDS = L, MD0 = L, MD1 = H;    4lines

0000	0001	-----	0013	0014	-----	001F
0014	0015	-----	0027	0028	-----	0033
0028	0029	-----	003B	003C	-----	0047
003C	003D	-----	004F	0050	-----	005B



	<b>PRODUCT SPEC.</b>	<b>MODE NO.</b>	<b>PAGE</b>	<b>15/21</b>
		MC240064A6W-FPTLW		

**(4) Set Graphic Area**

This command can be used define the columns of the graphic display

**Example :** LCD size: 20columns , 2lines      Graphic home address: 0000H  
 Graphic area: 0014H                              MD2 = H, MD3 = H;    0014H

DUAL = H, MDS = L, MD0 = H, MD1 = H; 2lines

0000	0001	-----	0013	0014	-----	001F
0014	0015	-----	0027	0028	-----	0033
0028	0029	-----	003B	003C	-----	0047
003C	003D	-----	004F	0050	-----	005B
0050	0051	-----	0063	0064	-----	006F
0064	0065	-----	0077	0078	-----	0083
0078	0079	-----	008B	008C	-----	0097
008C	008D	-----	009F	00A0	-----	00AB
00A0	00A1	-----	00B3	00B4	-----	00BF
00B4	00B5	-----	00C7	00C8	-----	00D3
00C8	00C9	-----	00DB	00DC	-----	00E7
00DC	00DD	-----	00EF	00F0	-----	00FD
00F0	00F1	-----	0103	0104	-----	011F
0104	0105	-----	0127	0128	-----	0123
0128	0129	-----	013B	013C	-----	0147
013C	013D	-----	014F	0150	-----	015B

**Mode Set**

The display mode does not change until the next command is sent. In Internal Character Generator mode, character codes 00H to 7FH are assigned to the built - in Character Generator RAM. The character codes 80H to FFH are automatically assigned to the external Character Generator RAM

**Example :** (Note: Attribute functions can only be applied to text display , since the attribute data is placed in the graphic RAM area. )

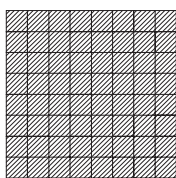

GRAPHIC

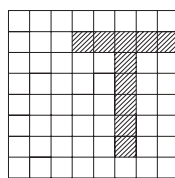

TEXT

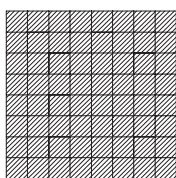

OR

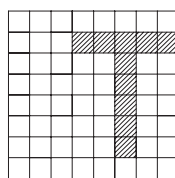

AND

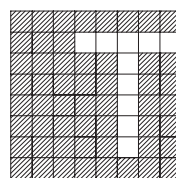

EXOR



	<b>PRODUCT SPEC.</b>	<b>MODE NO.</b>	<b>PAGE</b>	<b>16/21</b>
		MC240064A6W-FPTLW		

### Attribute Function

The attribute operations are reverse display, character blink and inhibit. The attribute data is written into the graphic area which was defined by the Set Control Word command. Only text display is possible in attribute function mode; graphic display is automatically disabled. However, the Display Mode command must be used to turn both Text and Graphic on in order for the Attribute Function to be available.

#### Attribute RAM 1 byte

X	X	X	X	d3	d2	d1	d0
---	---	---	---	----	----	----	----

d3	d2	d1	d0	FUNCTION
0	0	0	0	Normal display
0	1	0	1	Reverse display
0	0	1	1	Inhibit display
1	0	0	0	Blink of normal display
1	1	0	1	Blink of reverse display
1	0	1	1	Blink of inhibit of display

X: invalid

### Display Mode

It is necessary to turn on Text display and Graphic display in the following cases

- a) Combination of text / graphic display
- b) Attribute function

### Cursor Patten Select

When cursor display is ON, this command selects the cursor pattern in the range 1 line to 8 lines. The cursor address is defined by the Cursor Pointer Set command.

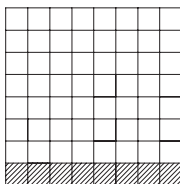

1-line cursor

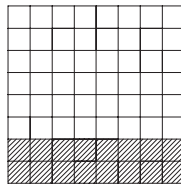

2-line cursor

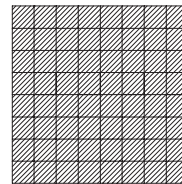

8-line cursor

	<b>PRODUCT SPEC.</b>	<b>MODE NO.</b>	<b>PAGE</b> 17/21
		MC240064A6W-FPTLW	

### Data Auto Read / Write

This command is convenient for sending a full screen of data from the external display RAM. After setting Auto mode, a Data Write ( or Read ) command is need not be sent between each datum. A data Auto Write ( or Read ) command must be sent after a set Address Pointer command. After this command, the address pointer is automatically incremented by 1 after each datum. In Auto mode, the LCM cannot accept any other commands. The Auto Rest command must be sent to the LCM after all data has been sent to clear Auto mode.

### Data Read / Write

This command is used for writing data from the MPU to external display RAM , and reading data from external display RAM to the MPU. Data Write / Read should be executed after setting address using SetAddress Pointer command. The address pointer can be automatically incremented or decrement using this command.

**Note:** This command is necessary for each 1-byte datum.  
Refer to the following flowchart.

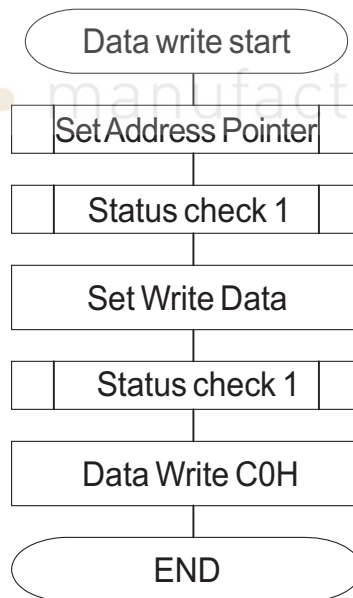
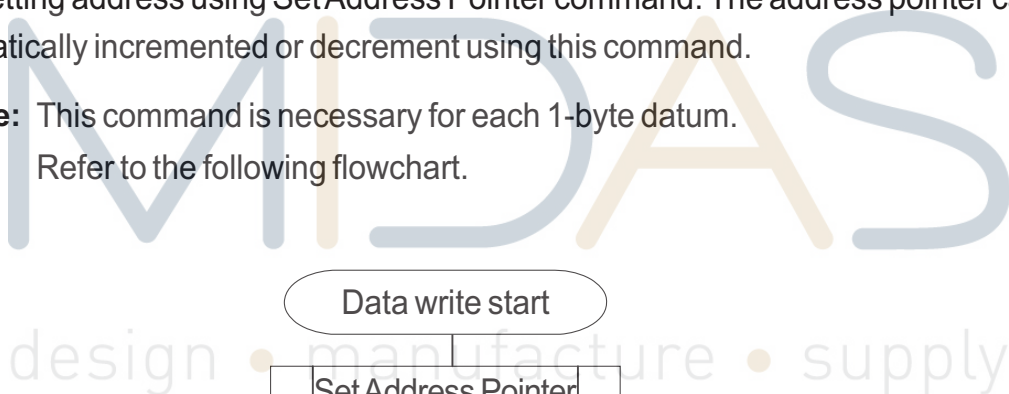

	<b>PRODUCT SPEC.</b>	<b>MODE NO.</b>	<b>PAGE</b> 18/21
		MC240064A6W-FPTLW	

### Screen Peek

The command is used transfer 1 byte of displayed data to the data stack , this byte can then be read from the MPU by data access. The logical combination of text and graphic display data on the LCD screen can be read by this command.

The status (STA6) should be checked just after the Screen Peek command. If the address determined by the Set Address Pointer command. Is not in the graphic area, this command is ignored and a status flag (STA6) is set.

Refer to the following flowchart

**Note:** This command is available when hardware column number and software column number are the same. Hardware column number is related to MD2 AND MD3 setting. Software column number is related to Set Text Area and Set Graphic Area command.

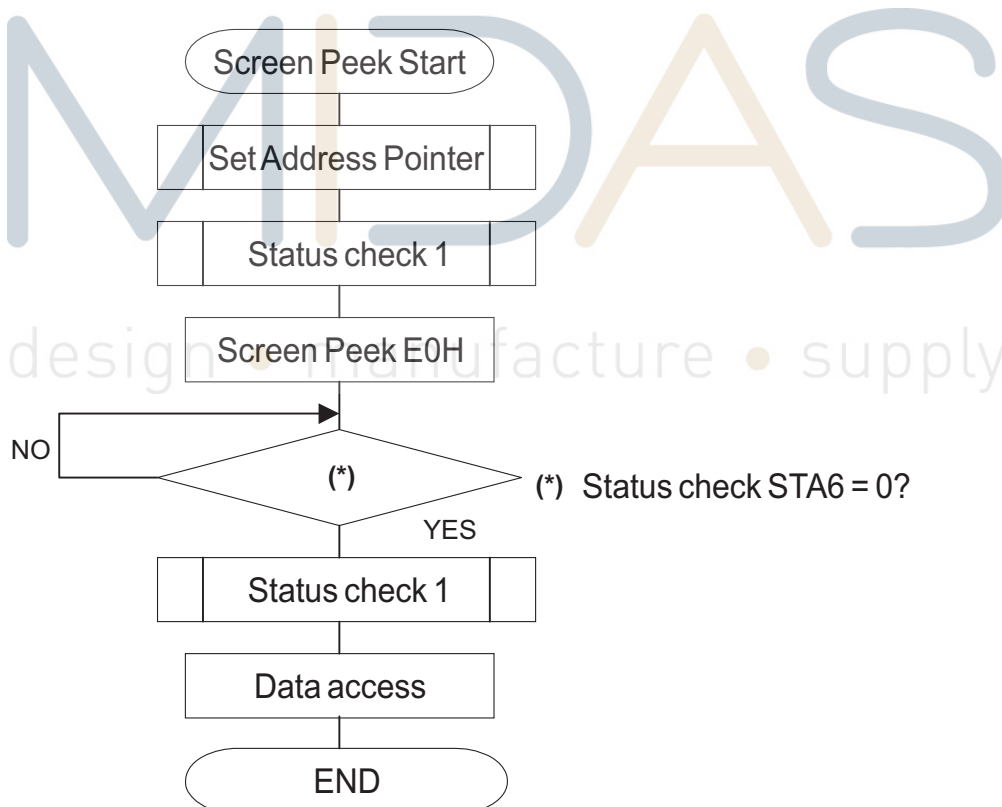

**(Note)** This command is available when hardware column number and software column number are the same. Hardware column number is related to MD2 and MD3 setting. Software column number is related to Set Text Area and Set Graphic Area command.

	PRODUCT SPEC.	MODE NO.	PAGE	19/21
		MC240064A6W-FPTLW		

### Screen Copy

This command copies a single raster line of data to the graphic area.

The start point must be set using the Set Address Pointer command.

Refer to the following flowchart.

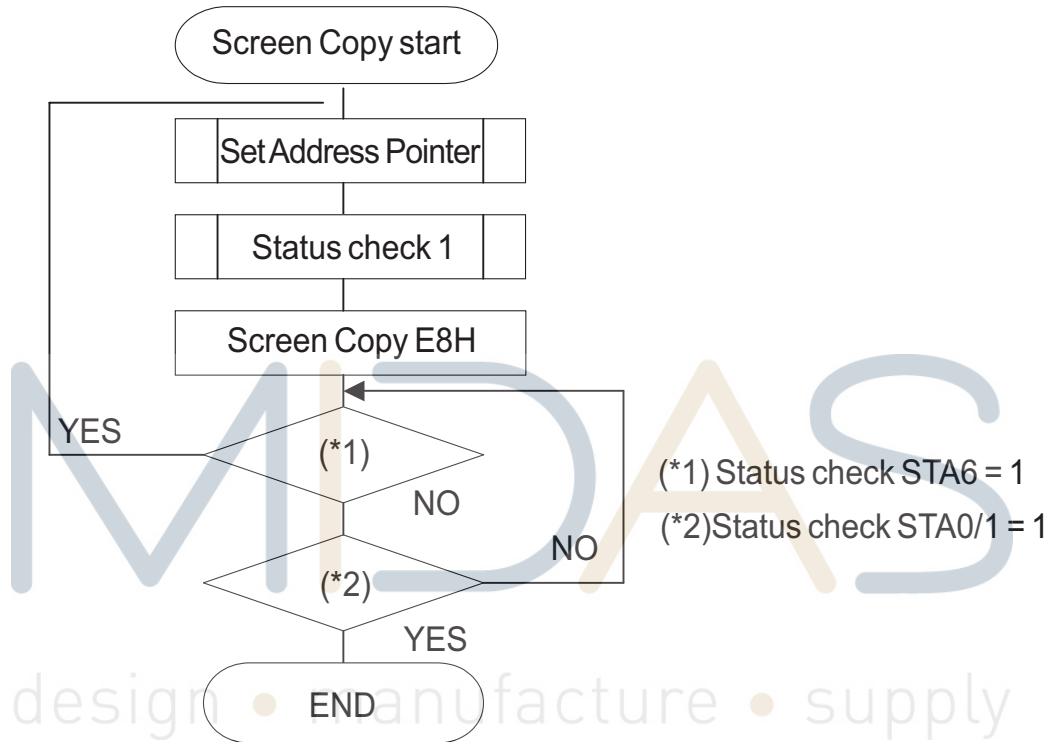

**Note 1 :** If the attribute function is being used, this command is not available. (With attribute data is graphic area data ) .

**Note 2 :** With Dual -Scan, this command cannot be used ( because the LCM cannot separate the upper screen data and lower screen data ).

**Note 3 :** This command is available when hardware column number and software column number are the same.

### Bite Set/Reset

This command use to set or reset a bit of the byte specified by the address pointer. Only one bit can be set/reset at a time.

Refer to the following flowchart.



**BOOKBINDING AREA**

	<b>PRODUCT SPEC.</b>	<b>MODE NO.</b>	<b>PAGE 21/21</b>
		MC240064A6W-FPTLW	

**15. PACKING DETAIL**

<b>WITH LED BKL</b>	
15 PCS/BOX	
8 BOXES/CARTON	
120 PCS/CARTON	
18.00 KGS/CTN(G.W.)	
0.07 M <sup>3</sup> /CARTON	

<b>NOTE</b>
1. The weight is estimated for reference only.
2. Packing detail may be changed without notice.

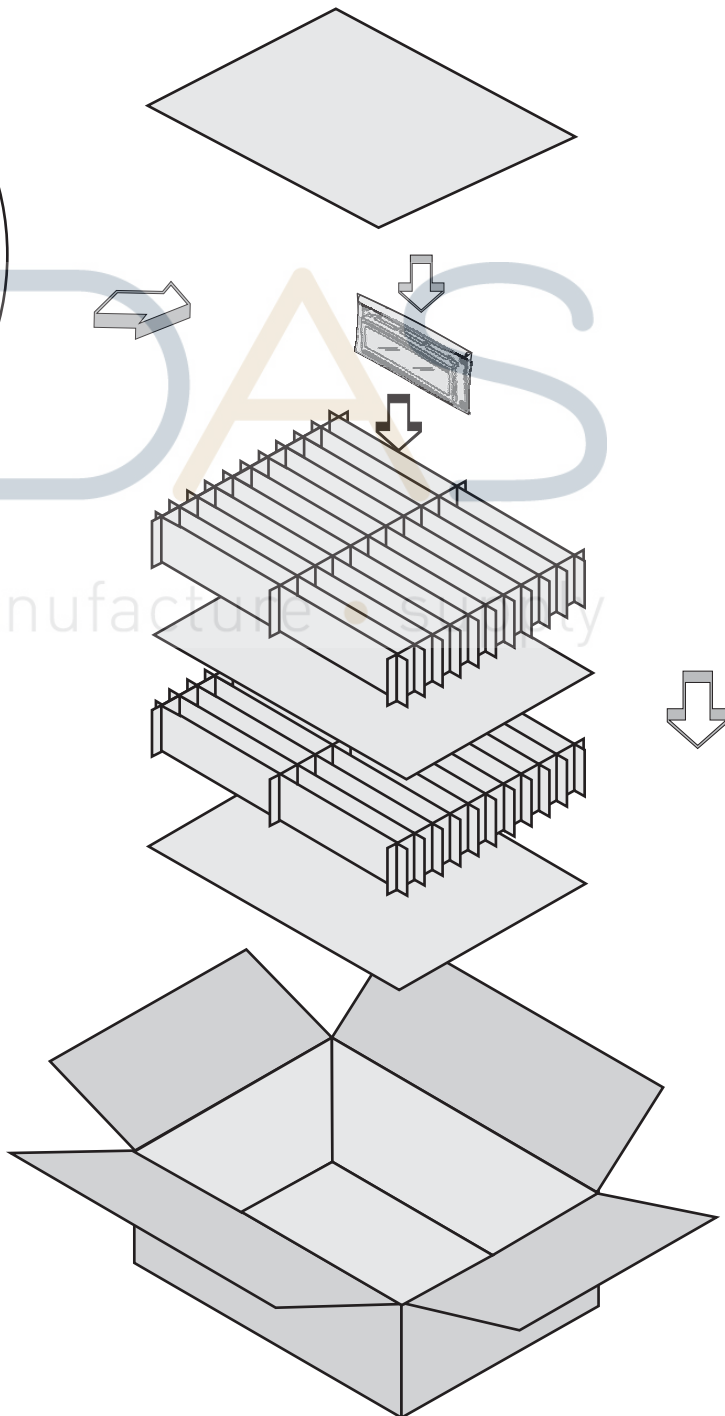
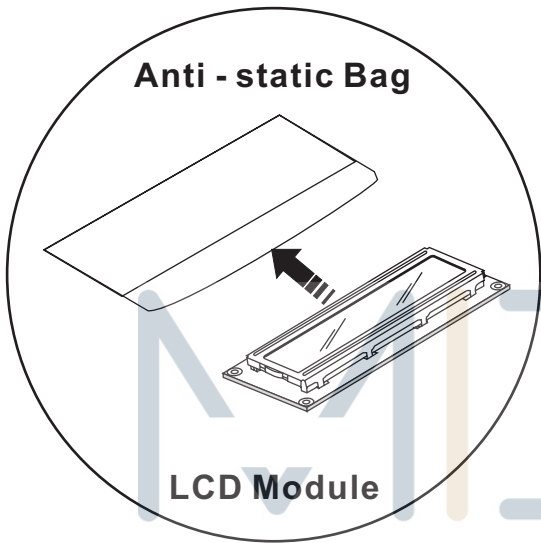

**BOX** 

**CARTON** 