



December 2014

# 4N29M, 4N30M, 4N32M, 4N33M, H11B1M, TIL113M 6-Pin DIP General Purpose Photodarlington Optocoupler

## Features

- High Sensitivity to Low Input Drive Current
- Meets or Exceeds All JEDEC Registered Specifications
- Safety and Regulatory Approvals:
  - UL1577, 4,170 VAC<sub>RMS</sub> for 1 Minute
- DIN-EN/IEC60747-5-5, 850 V Peak Working Insulation Voltage

## Applications

- Low Power Logic Circuits
- Telecommunications Equipment
- Portable Electronics
- Solid State Relays
- Interfacing Coupling Systems of Different Potentials and Impedances

## Description

The 4N29M, 4N30M, 4N32M, 4N33M, H11B1M, and TIL113M have a gallium arsenide infrared emitter optically coupled to a silicon planar photodarlington.

## Schematic

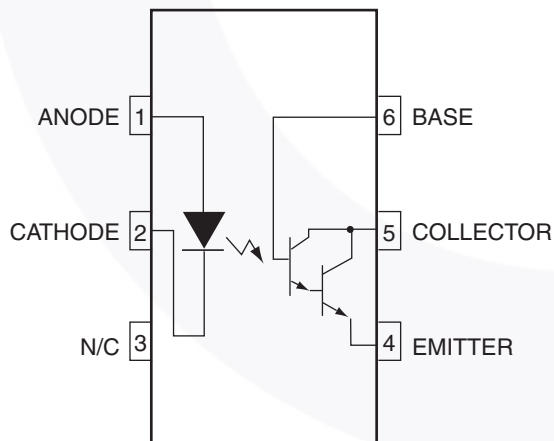

Figure 1. Schematic

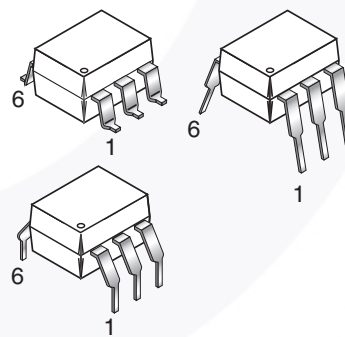

Figure 2. Package Outlines

## Safety and Insulation Ratings

As per DIN EN/IEC 60747-5-5, this optocoupler is suitable for “safe electrical insulation” only within the safety limit data. Compliance with the safety ratings shall be ensured by means of protective circuits.

Parameter		Characteristics
Installation Classifications per DIN VDE 0110/1.89 Table 1, For Rated Mains Voltage	< 150 V <sub>RMS</sub>	I–IV
	< 300 V <sub>RMS</sub>	I–IV
Climatic Classification		55/100/21
Pollution Degree (DIN VDE 0110/1.89)		2
Comparative Tracking Index		175

Symbol	Parameter	Value	Unit
V <sub>PR</sub>	Input-to-Output Test Voltage, Method A, V <sub>IORM</sub> × 1.6 = V <sub>PR</sub> , Type and Sample Test with t <sub>m</sub> = 10 s, Partial Discharge < 5 pC	1360	V <sub>peak</sub>
	Input-to-Output Test Voltage, Method B, V <sub>IORM</sub> × 1.875 = V <sub>PR</sub> , 100% Production Test with t <sub>m</sub> = 1 s, Partial Discharge < 5 pC	1594	V <sub>peak</sub>
V <sub>IORM</sub>	Maximum Working Insulation Voltage	850	V <sub>peak</sub>
V <sub>IOTM</sub>	Highest Allowable Over-Voltage	6000	V <sub>peak</sub>
	External Creepage	≥ 7	mm
	External Clearance	≥ 7	mm
	External Clearance (for Option TV, 0.4" Lead Spacing)	≥ 10	mm
DTI	Distance Through Insulation (Insulation Thickness)	≥ 0.5	mm
T <sub>S</sub>	Case Temperature <sup>(1)</sup>	175	°C
I <sub>S,INPUT</sub>	Input Current <sup>(1)</sup>	350	mA
P <sub>S,OUTPUT</sub>	Output Power <sup>(1)</sup>	800	mW
R <sub>IO</sub>	Insulation Resistance at T <sub>S</sub> , V <sub>IO</sub> = 500 V <sup>(1)</sup>	> 10 <sup>9</sup>	Ω

### Note:

1. Safety limit values – maximum values allowed in the event of a failure.

## Absolute Maximum Ratings

Stresses exceeding the absolute maximum ratings may damage the device. The device may not function or be operable above the recommended operating conditions and stressing the parts to these levels is not recommended. In addition, extended exposure to stresses above the recommended operating conditions may affect device reliability. The absolute maximum ratings are stress ratings only.

Symbol	Parameter	Value	Unit
<b>TOTAL DEVICE</b>			
$T_{STG}$	Storage Temperature	-40 to +125	°C
$T_{OPR}$	Operating Temperature	-40 to +100	°C
$T_J$	Junction Temperature	-40 to +125	°C
$T_{SOL}$	Lead Solder Temperature	260 for 10 seconds	°C
$P_D$	Total Device Power Dissipation @ $T_A = 25^\circ\text{C}$	270	mW
	Derate Above $25^\circ\text{C}$	3.3	mW/°C
<b>EMITTER</b>			
$I_F$	Continuous Forward Current	80	mA
$V_R$	Reverse Voltage	3	V
$I_F(pk)$	Forward Current – Peak (300 $\mu\text{s}$ , 2% Duty Cycle)	3.0	A
$P_D$	LED Power Dissipation @ $T_A = 25^\circ\text{C}$	120	mW
	Derate above $25^\circ\text{C}$	2.0	mW/°C
<b>DETECTOR</b>			
$BV_{CEO}$	Collector-Emitter Breakdown Voltage	30	V
$BV_{CBO}$	Collector-Base Breakdown Voltage	30	V
$BV_{ECO}$	Emitter-Collector Breakdown Voltage	5	V
$P_D$	Detector Power Dissipation @ $T_A = 25^\circ\text{C}$	150	mW
	Derate Above $25^\circ\text{C}$	2.0	mW/°C
$I_C$	Continuous Collector Current	150	mA

## Electrical Characteristics

$T_A = 25^\circ\text{C}$  Unless otherwise specified.

### Individual Component Characteristics

Symbol	Parameter	Test Conditions	Device	Min.	Typ.	Max.	Unit
<b>EMITTER</b>							
$V_F$	Input Forward Voltage <sup>(2)</sup>	$I_F = 10\text{ mA}$	4NXXM		1.2	1.5	V
			H11B1M, TIL113M	0.8	1.2	1.5	V
$I_R$	Reverse Leakage Current <sup>(2)</sup>	$V_R = 3.0\text{ V}$	4NXXM		0.001	100	$\mu\text{A}$
		$V_R = 6.0\text{ V}$	H11B1M, TIL113M		0.001	10	$\mu\text{A}$
C	Capacitance <sup>(2)</sup>	$V_F = 0\text{V}, f = 1.0\text{ MHz}$	All		150		pF
<b>DETECTOR</b>							
$BV_{CEO}$	Collector-Emitter Breakdown Voltage <sup>(2)</sup>	$I_C = 1.0\text{ mA}, I_B = 0$	4NXXM, TIL113M	30	60		V
			H11B1M	25	60		V
$BV_{CBO}$	Collector-Base Breakdown Voltage <sup>(2)</sup>	$I_C = 100\ \mu\text{A}, I_E = 0$	All	30	100		V
$BV_{ECO}$	Emitter-Collector Breakdown Voltage <sup>(2)</sup>	$I_E = 100\ \mu\text{A}, I_B = 0$	4NXXM	5.0	10		V
			H11B1M, TIL113M	7	10		V
$I_{CEO}$	Collector-Emitter Dark Current <sup>(2)</sup>	$V_{CE} = 10\text{ V}, \text{Base Open}$	All		1	100	nA

**Notes:**

2. Indicates JEDEC registered data.

## Electrical Characteristics (Continued)

$T_A = 25^\circ\text{C}$  Unless otherwise specified.

### Transfer Characteristics

Symbol	Parameter	Test Conditions	Device	Min.	Typ.	Max.	Unit
<b>DC CHARACTERISTICS</b>							
$I_{C(CTR)}$	Collector Output Current <sup>(3)(4)(5)</sup>	$I_F = 10\text{ mA}, V_{CE} = 10\text{ V}, I_B = 0$	4N32M, 4N33M	50 (500)			mA (%)
			4N299M, 4N300M	10 (100)			mA (%)
		$I_F = 1\text{ mA}, V_{CE} = 5\text{ V}$	H11B1M	5 (500)			mA (%)
		$I_F = 10\text{ mA}, V_{CE} = 1\text{ V}$	TIL113M	30 (300)			mA (%)
$V_{CE(SAT)}$	Saturation Voltage <sup>(3)(5)</sup>	$I_F = 8\text{ mA}, I_C = 2.0\text{ mA}$	4NXXM			1.0	V
			TIL113M			1.25	V
		$I_F = 1\text{ mA}, I_C = 1\text{ mA}$	H11B1M			1.0	V
<b>AC CHARACTERISTICS</b>							
$t_{on}$	Turn-on Time	$I_F = 200\text{ mA}, I_C = 50\text{ mA}, V_{CC} = 10\text{ V}, R_L = 100\ \Omega$	4NXXM, TIL113M			5.0	$\mu\text{s}$
		$I_F = 10\text{ mA}, V_{CE} = 10\text{ V}, R_L = 100\ \Omega$	H11B1M		25		$\mu\text{s}$
$t_{off}$	Turn-off Time	$I_F = 200\text{ mA}, I_C = 50\text{ mA}, V_{CC} = 10\text{ V}, R_L = 100\ \Omega$	4N32M, 4N33M, TIL113M			100	$\mu\text{s}$
			4N299M, 4N300M			40	$\mu\text{s}$
		$I_F = 10\text{ mA}, V_{CE} = 10\text{ V}, R_L = 100\ \Omega$	H11B1M		18		$\mu\text{s}$
BW	Bandwidth <sup>(6)(7)</sup>				30		kHz

#### Notes:

- Indicates JEDEC registered data.
- The current transfer ratio ( $I_C / I_F$ ) is the ratio of the detector collector current to the LED input current.
- Pulse test: pulse width = 300  $\mu\text{s}$ , duty cycle  $\leq 2.0\%$ .
- $I_F$  adjusted to  $I_C = 2.0\text{ mA}$  and  $I_C = 0.7\text{ mA rms}$ .
- The frequency at which  $I_C$  is 3 dB down from the 1 kHz value.

### Isolation Characteristics

Symbol	Characteristic	Test Conditions	Min.	Typ.	Max.	Unit
$V_{ISO}$	Input-Output Isolation Voltage	$t = 1\text{ Minute}$	4170			$V_{AC(RMS)}$
$C_{ISO}$	Isolation Capacitance	$V_{I-O} = 0\text{ V}, f = 1\text{ MHz}$		0.2		pF
$R_{ISO}$	Isolation Resistance	$V_{I-O} = \pm 500\text{ VDC}, T_A = 25^\circ\text{C}$	$10^{11}$			$\Omega$

### Typical Performance Curves

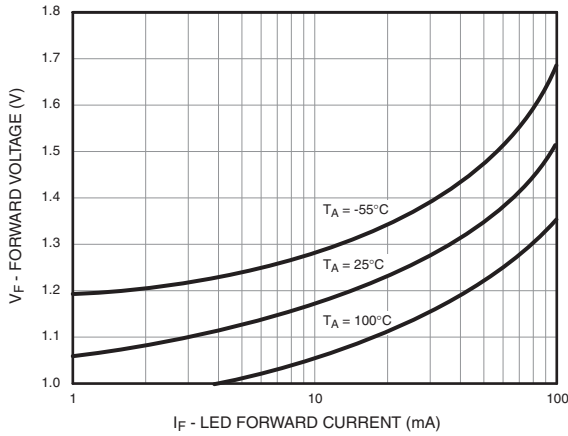

**Figure 3. LED Forward Voltage vs. Forward Current**

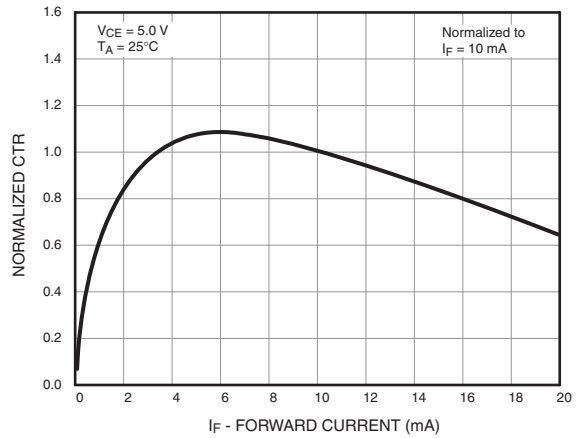

**Figure 4. Normalized CTR vs. Forward Current**

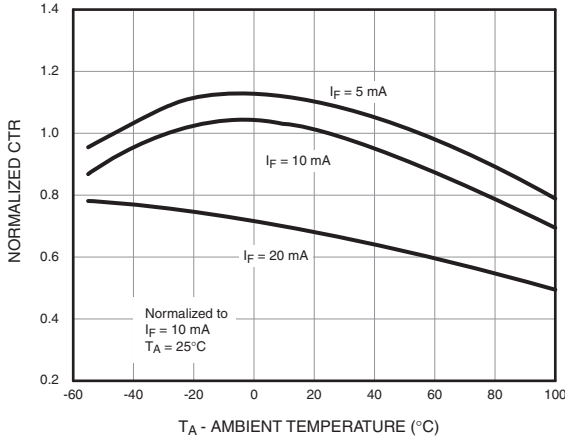

**Figure 5. Normalized CTR vs. Ambient Temperature**

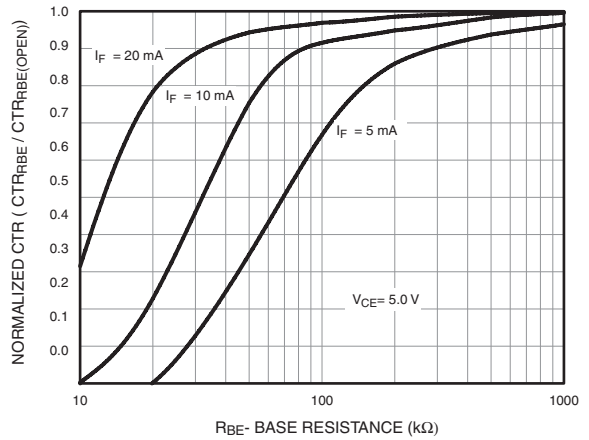

**Figure 6. CTR vs. R\_BE (Unsaturated)**

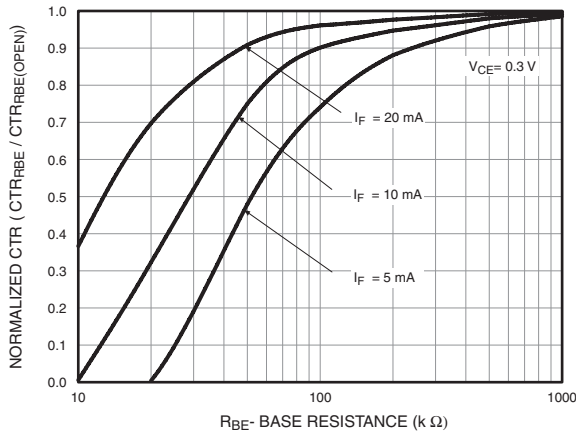

**Figure 7. CTR vs. R\_BE (Saturated)**

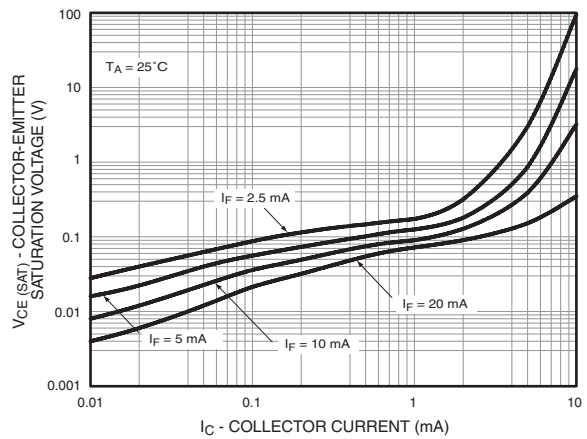

**Figure 8. Collector-Emitter Saturation Voltage vs. Collector Current**

### Typical Performance Curves (Continued)

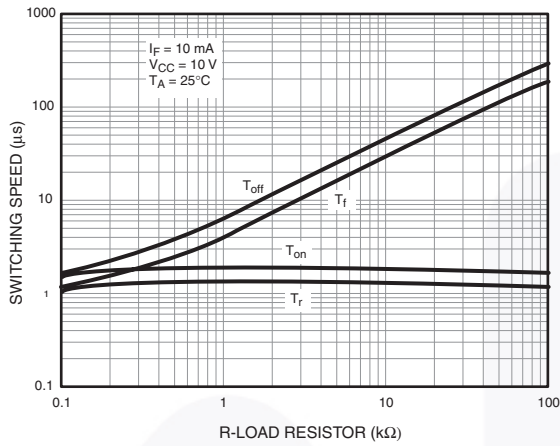

Figure 9. Switching Speed vs. Load Resistor

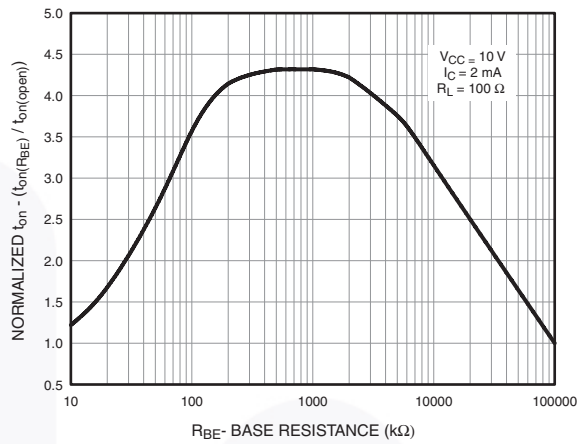

Figure 10. Normalized  $t_{on}$  vs.  $R_{BE}$

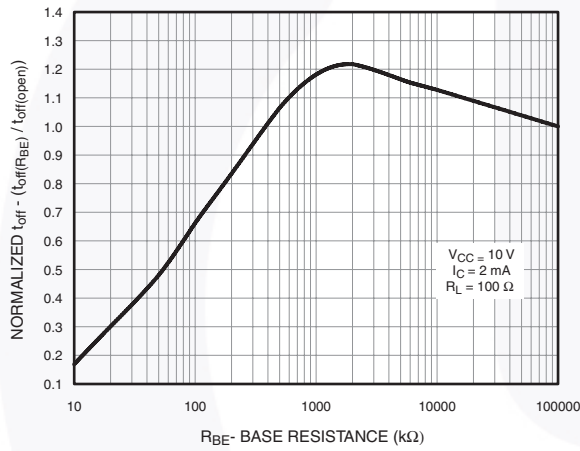

Figure 11. Normalized  $t_{off}$  vs.  $R_{BE}$

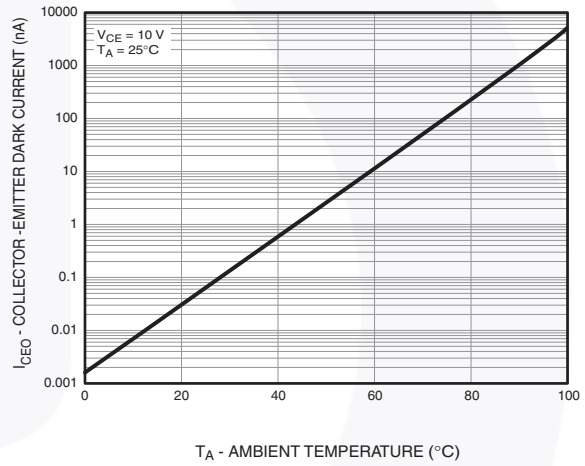

Figure 12. Dark Current vs. Ambient Temperature

### Switching Time Test Circuit and Waveform

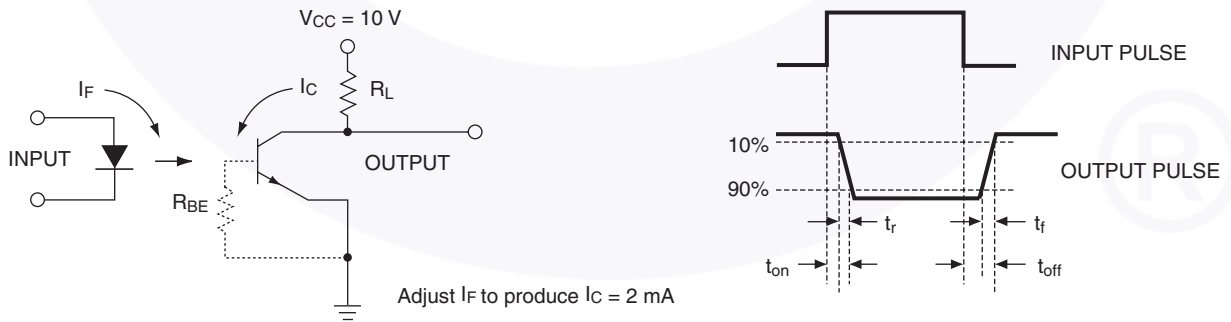

Figure 13. Switching Time Test Circuit and Waveform

### Reflow Profile

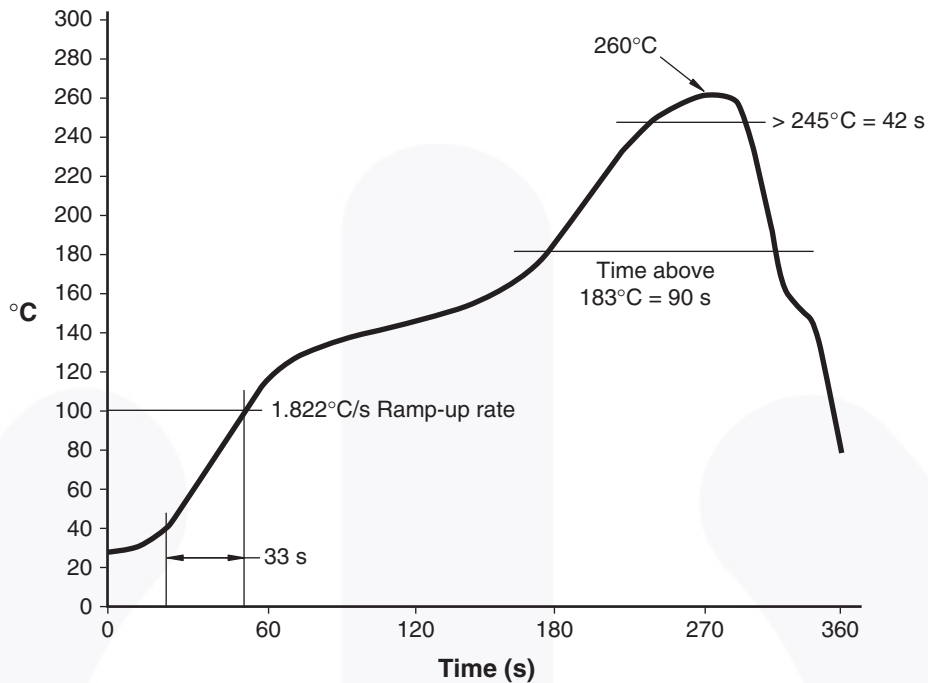

Figure 14. Reflow Profile



## Ordering Information

Part Number	Package	Packing Method
4N29M	DIP 6-Pin	Tube (50 Units)
4N29SM	SMT 6-Pin (Lead Bend)	Tube (50 Units)
4N29SR2M	SMT 6-Pin (Lead Bend)	Tape and Reel (1000 Units)
4N29VM	DIP 6-Pin, DIN EN/IEC60747-5-5 Option	Tube (50 Units)
4N29SVM	SMT 6-Pin (Lead Bend), DIN EN/IEC60747-5-5 Option	Tube (50 Units)
4N29SR2VM	SMT 6-Pin (Lead Bend), DIN EN/IEC60747-5-5 Option	Tape and Reel (1000 Units)
4N29TVM	DIP 6-Pin, 0.4" Lead Spacing, DIN EN/IEC60747-5-5 Option	Tube (50 Units)

**Note:**

8. The product orderable part number system listed in this table also applies to the 4N30M, 4N32M, 4N33M, H11B1M, and TIL113M devices.

## Marking Information

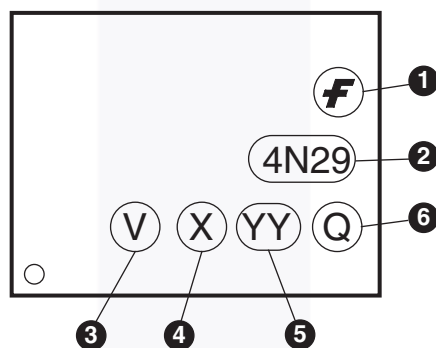

Figure 15. Top Mark

Table 1. Top Mark Definitions

1	Fairchild Logo
2	Device Number
3	DIN EN/IEC60747-5-5 Option (only appears on component ordered with this option)
4	One-Digit Year Code, e.g., "4"
5	Digit Work Week, Ranging from "01" to "53"
6	Assembly Package Code



- NOTES:
- A) NO STANDARD APPLIES TO THIS PACKAGE.
  - B) ALL DIMENSIONS ARE IN MILLIMETERS.
  - C) DIMENSIONS ARE EXCLUSIVE OF BURRS, MOLD FLASH, AND TIE BAR EXTRUSION
  - D) DRAWING FILENAME AND REVISION: MKT-N06BREV4.





LAND PATTERN RECOMMENDATION



NOTES:

- A) NO STANDARD APPLIES TO THIS PACKAGE.
- B) ALL DIMENSIONS ARE IN MILLIMETERS.
- C) DIMENSIONS ARE EXCLUSIVE OF BURRS, MOLD FLASH, AND TIE BAR EXTRUSION
- D) DRAWING FILENAME AND REVISION : MKT-N06CREV4.





NOTES:

- A) NO STANDARD APPLIES TO THIS PACKAGE.
- B) ALL DIMENSIONS ARE IN MILLIMETERS.
- C) DIMENSIONS ARE EXCLUSIVE OF BURRS, MOLD FLASH, AND TIE BAR EXTRUSION
- D) DRAWING FILENAME AND REVISION: MKT-N06Drev4





**TRADEMARKS**

The following includes registered and unregistered trademarks and service marks, owned by Fairchild Semiconductor and/or its global subsidiaries, and is not intended to be an exhaustive list of all such trademarks.

AccuPower™  
AttitudeEngine™  
Awinda®  
AX-CAP®\*  
BitSiC™  
Build it Now™  
CorePLUS™  
CorePOWER™  
CROSSVOL™  
CTL™  
Current Transfer Logic™  
DEUXPEED®  
Dual Cool™  
EcoSPARK®  
EfficientMax™  
ESBC™  
F®  
Fairchild®  
Fairchild Semiconductor®  
FACT Quiet Series™  
FACT®  
FastvCore™  
FETBench™  
FPS™

F-PFS™  
FRFET®  
Global Power Resource™  
GreenBridge™  
Green FPS™  
Green FPS™ e-Series™  
Gmax™  
GTO™  
IntelliMAX™  
ISOPLANAR™  
Making Small Speakers Sound Louder and Better™  
MegaBuck™  
MICROCOUPLER™  
MicroFET™  
MicroPak™  
MicroPak2™  
MillerDrive™  
MotionMax™  
MotionGrid®  
MTi®  
MTx®  
MVN®  
mWSaver®  
OptoHiT™  
OPTOLOGIC®

OPTOPLANAR®  
Power Supply WebDesigner™  
PowerTrench®  
PowerXS™  
Programmable Active Droop™  
QFET®  
QS™  
Quiet Series™  
RapidConfigure™  
Saving our world, 1mW/W/kW at a time™  
SignalWise™  
SmartMax™  
SMART START™  
Solutions for Your Success™  
SPM®  
STEALTH™  
SuperFET®  
SuperSOT™-3  
SuperSOT™-6  
SuperSOT™-8  
SupreMOS®  
SyncFET™  
Sync-Lock™

SYSTEM GENERAL®  
TinyBoost®  
TinyBuck®  
TinyCalc™  
TinyLogic®  
TINYOPTO™  
TinyPower™  
TinyPWM™  
TinyWire™  
TranSiC™  
TriFault Detect™  
TRUECURRENT®\*  
µSerDes™  
SerDes®  
UHC®  
Ultra FRFET™  
UniFET™  
VCX™  
VisualMax™  
VoltagePlus™  
XS™  
Xsens™  
仙童®

\* Trademarks of System General Corporation, used under license by Fairchild Semiconductor.

**DISCLAIMER**

FAIRCHILD SEMICONDUCTOR RESERVES THE RIGHT TO MAKE CHANGES WITHOUT FURTHER NOTICE TO ANY PRODUCTS HEREIN TO IMPROVE RELIABILITY, FUNCTION, OR DESIGN. TO OBTAIN THE LATEST, MOST UP-TO-DATE DATASHEET AND PRODUCT INFORMATION, VISIT OUR WEBSITE AT [HTTP://WWW.FAIRCHILDSEMI.COM](http://www.fairchildsemi.com). FAIRCHILD DOES NOT ASSUME ANY LIABILITY ARISING OUT OF THE APPLICATION OR USE OF ANY PRODUCT OR CIRCUIT DESCRIBED HEREIN; NEITHER DOES IT CONVEY ANY LICENSE UNDER ITS PATENT RIGHTS, NOR THE RIGHTS OF OTHERS. THESE SPECIFICATIONS DO NOT EXPAND THE TERMS OF FAIRCHILD'S WORLDWIDE TERMS AND CONDITIONS, SPECIFICALLY THE WARRANTY THEREIN, WHICH COVERS THESE PRODUCTS.

**AUTHORIZED USE**

Unless otherwise specified in this data sheet, this product is a standard commercial product and is not intended for use in applications that require extraordinary levels of quality and reliability. This product may not be used in the following applications, unless specifically approved in writing by a Fairchild officer: (1) automotive or other transportation, (2) military/aerospace, (3) any safety critical application – including life critical medical equipment – where the failure of the Fairchild product reasonably would be expected to result in personal injury, death or property damage. Customer's use of this product is subject to agreement of this Authorized Use policy. In the event of an unauthorized use of Fairchild's product, Fairchild accepts no liability in the event of product failure. In other respects, this product shall be subject to Fairchild's Worldwide Terms and Conditions of Sale, unless a separate agreement has been signed by both Parties.

**ANTI-COUNTERFEITING POLICY**

Fairchild Semiconductor Corporation's Anti-Counterfeiting Policy. Fairchild's Anti-Counterfeiting Policy is also stated on our external website, [www.fairchildsemi.com](http://www.fairchildsemi.com), under Terms of Use

Counterfeiting of semiconductor parts is a growing problem in the industry. All manufacturers of semiconductor products are experiencing counterfeiting of their parts. Customers who inadvertently purchase counterfeit parts experience many problems such as loss of brand reputation, substandard performance, failed applications, and increased cost of production and manufacturing delays. Fairchild is taking strong measures to protect ourselves and our customers from the proliferation of counterfeit parts. Fairchild strongly encourages customers to purchase Fairchild parts either directly from Fairchild or from Authorized Fairchild Distributors who are listed by country on our web page cited above. Products customers buy either from Fairchild directly or from Authorized Fairchild Distributors are genuine parts, have full traceability, meet Fairchild's quality standards for handling and storage and provide access to Fairchild's full range of up-to-date technical and product information. Fairchild and our Authorized Distributors will stand behind all warranties and will appropriately address any warranty issues that may arise. Fairchild will not provide any warranty coverage or other assistance for parts bought from Unauthorized Sources. Fairchild is committed to combat this global problem and encourage our customers to do their part in stopping this practice by buying direct or from authorized distributors.

**PRODUCT STATUS DEFINITIONS**

**Definition of Terms**

Datasheet Identification	Product Status	Definition
Advance Information	Formative / In Design	Datasheet contains the design specifications for product development. Specifications may change in any manner without notice.
Preliminary	First Production	Datasheet contains preliminary data; supplementary data will be published at a later date. Fairchild Semiconductor reserves the right to make changes at any time without notice to improve design.
No Identification Needed	Full Production	Datasheet contains final specifications. Fairchild Semiconductor reserves the right to make changes at any time without notice to improve the design.
Obsolete	Not In Production	Datasheet contains specifications on a product that is discontinued by Fairchild Semiconductor. The datasheet is for reference information only.