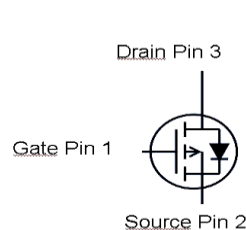
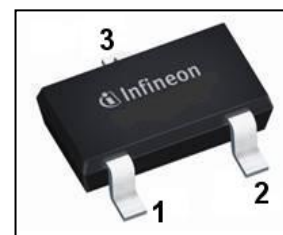

SIPMOS[®] Small-Signal-Transistor
Features

- P-Channel
- Enhancement mode / Logic level
- Avalanche rated
- Pb-free lead plating; RoHS compliant
- Footprint compatible to SOT23
- Qualified according to AEC Q101
- Halogen free according to IEC61249-2-21

Product Summary

V_{DS}	-100	V
$R_{DS(on),max}$	1.8	Ω
I_D	-0.36	A

PG-SC59

Type	Package	Tape and Reel Information	Marking	Halogen-free	Packing
BSR316P	PG-SC59	H6327 = 3000 pcs. / reel	LC	Yes	Non dry

Maximum ratings, at $T_j=25\text{ °C}$, unless otherwise specified

Parameter	Symbol	Conditions	Value	Unit
			steady state	
Continuous drain current	I_D	$T_A=25\text{ °C}$	-0.36	A
		$T_A=70\text{ °C}$	-0.29	
Pulsed drain current	$I_{D,pulse}$	$T_A=25\text{ °C}$	-1.44	
Avalanche energy, single pulse	E_{AS}	$I_D=-0.36\text{ A}$, $R_{GS}=25\ \Omega$	25	mJ
Gate source voltage	V_{GS}		± 20	V
Power dissipation	P_{tot}	$T_C=25\text{ °C}$	0.5	W
Operating and storage temperature	T_j , T_{stg}		-55 ... 150	$^{\circ}\text{C}$
ESD class		JESD22-A114-HBM	1A (250V to 500V)	
Soldering temperature			260 $^{\circ}\text{C}$	
IEC climatic category; DIN IEC 68-1			55/150/56	

Parameter	Symbol	Conditions	Values			Unit
			min.	typ.	max.	

Thermal characteristics

Thermal resistance, junction - ambient	R_{thJA}	minimal footprint, steady state	-	-	250	K/W
--	------------	---------------------------------	---	---	-----	-----

Electrical characteristics, at $T_j=25\text{ }^\circ\text{C}$, unless otherwise specified
Static characteristics

Drain-source breakdown voltage	$V_{(BR)DSS}$	$V_{GS}=0\text{ V}$, $I_D=-250\text{ }\mu\text{A}$	-	-	-100	V
Gate threshold voltage	$V_{GS(th)}$	$V_{DS}=V_{GS}$, $I_D=-170\text{ }\mu\text{A}$	-2	-1.5	-1	
Zero gate voltage drain current	I_{DSS}	$V_{DS}=-100\text{ V}$, $V_{GS}=0\text{ V}$, $T_j=25\text{ }^\circ\text{C}$	-	-0.1	-1	μA
		$V_{DS}=-100\text{ V}$, $V_{GS}=0\text{ V}$, $T_j=150\text{ }^\circ\text{C}$	-	-10	-100	
Gate-source leakage current	I_{GSS}	$V_{GS}=-20\text{ V}$, $V_{DS}=0\text{ V}$	-	-10	-100	nA
Drain-source on-state resistance	$R_{DS(on)}$	$V_{GS}=-4.5\text{ V}$, $I_D=-0.33\text{ A}$	-	1.8	2.2	Ω
		$V_{GS}=-10\text{ V}$, $I_D=-0.36\text{ A}$	-	1.3	1.8	
Transconductance	g_{fs}	$ V_{DS} >2 I_D R_{DS(on)max}$, $I_D=-0.29\text{ A}$	0.3	0.5	-	S

Parameter	Symbol	Conditions	Values			Unit
			min.	typ.	max.	

Dynamic characteristics³⁾

Input capacitance	C_{iss}	$V_{GS}=0\text{ V}, V_{DS}=-25\text{ V},$ $f=1\text{ MHz}$	-	124	165	pF
Output capacitance	C_{oss}		-	25	33	
Reverse transfer capacitance	C_{rss}		-	13	20	
Turn-on delay time	$t_{d(on)}$	$V_{DD}=-50\text{ V},$ $V_{GS}=-10\text{ V},$ $I_D=-0.36\text{ A}, R_{G,ext}=6\ \Omega$	-	5	8	ns
Rise time	t_r		-	6	9	
Turn-off delay time	$t_{d(off)}$		-	71	106	
Fall time	t_f		-	26	39	

Gate Charge Characteristics^{2), 3)}

Gate to source charge	Q_{gs}	$V_{DD}=-80\text{ V},$ $I_D=-0.36\text{ A}, V_{GS}=0\text{ to }-10\text{ V}$	-	0.3	0.4	nC
Gate to drain charge	Q_{gd}		-	1.6	2.4	
Gate charge total	Q_g		-	5.3	7.0	
Gate plateau voltage	$V_{plateau}$		-	-2.7	-	V

Reverse Diode

Diode continuous forward current	I_S	$T_C=25\text{ °C}$	-	-	-0.36	A
Diode pulse current	$I_{S,pulse}$		-	-	-1.44	
Diode forward voltage	V_{SD}	$V_{GS}=0\text{ V}, I_F=0.36\text{ A},$ $T_j=25\text{ °C}$	-	-0.8	-1.1	V
Reverse recovery time ³⁾	t_{rr}	$V_R=-50\text{ V}, I_F= I_S ,$ $di_F/dt=100\text{ A}/\mu\text{s}$	-	40.6	-	ns
Reverse recovery charge ³⁾	Q_{rr}		-	46.4	-	nC

²⁾ See figure 16 for gate charge parameter definition

³⁾ Defined by design. Not subjected to production test

1 Power dissipation

$P_{tot}=f(T_C)$

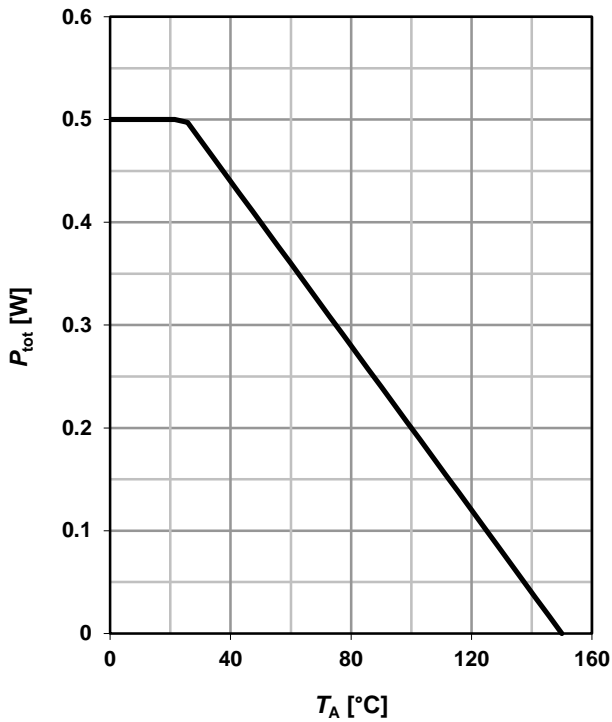

2 Drain current

$I_D=f(T_C); |V_{GS}| \geq 10\text{ V}$

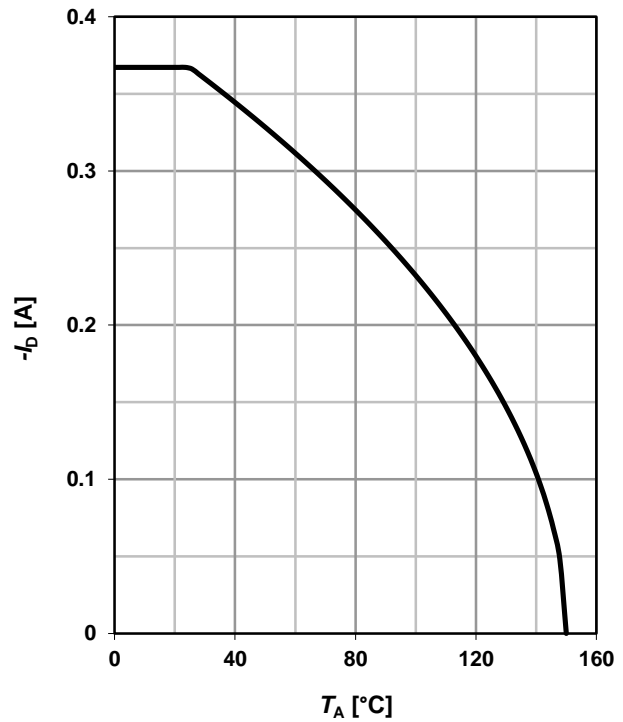

3 Safe operating area

$I_D=f(V_{DS}); T_C=25\text{ °C}; D=0$

parameter: t_p

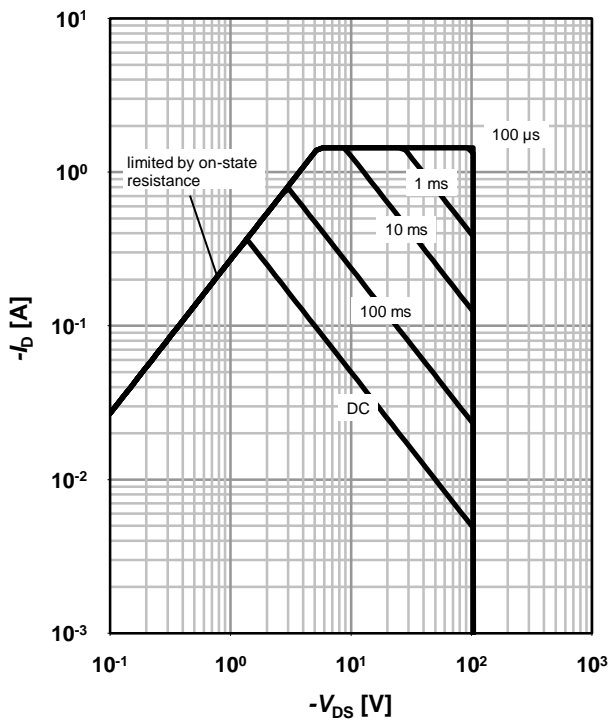

4 Max. transient thermal impedance

$Z_{thJC}=f(t_p)$

parameter: $D=t_p/T$

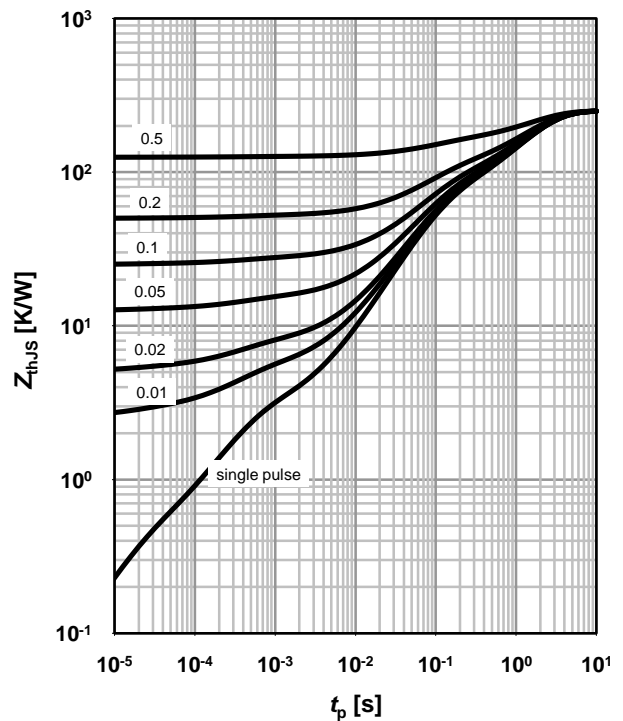

5 Typ. output characteristics

$I_D = f(V_{DS}); T_j = 25\text{ °C}$

parameter: V_{GS}

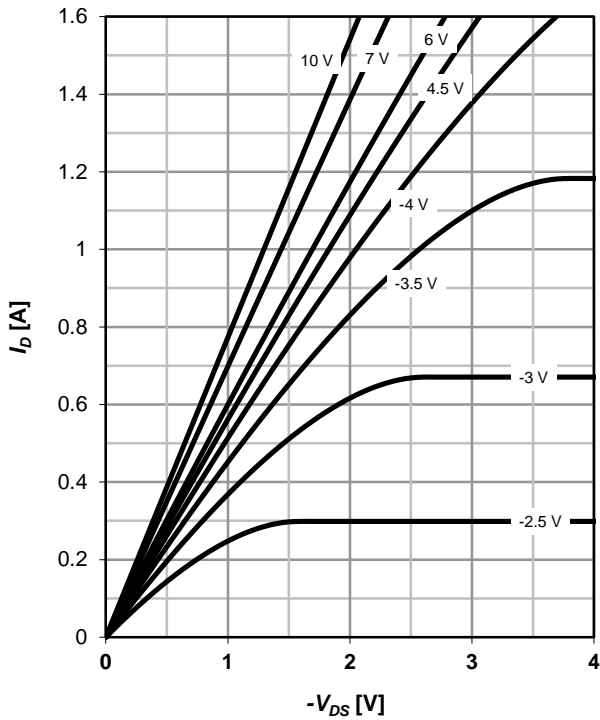

6 Typ. drain-source on resistance

$R_{DS(on)} = f(I_D); T_j = 25\text{ °C}$

parameter: V_{GS}

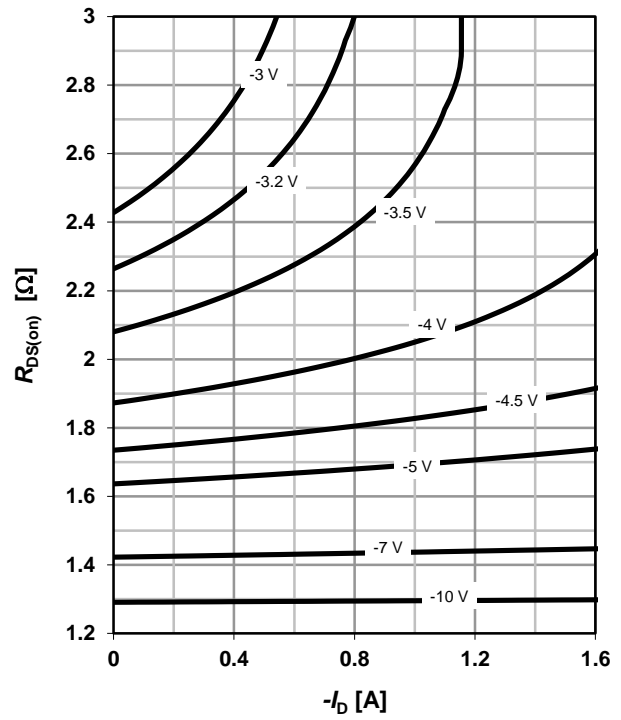

7 Typ. transfer characteristics

$I_D = f(V_{GS}); |V_{DS}| > 2|I_D|R_{DS(on)max}$

parameter: T_j

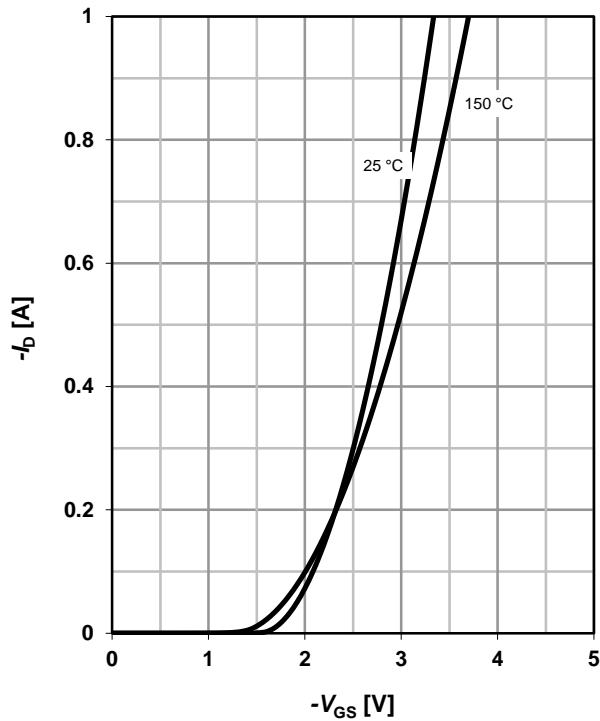

8 Typ. forward transconductance

$g_{fs} = f(I_D); T_j = 25\text{ °C}$

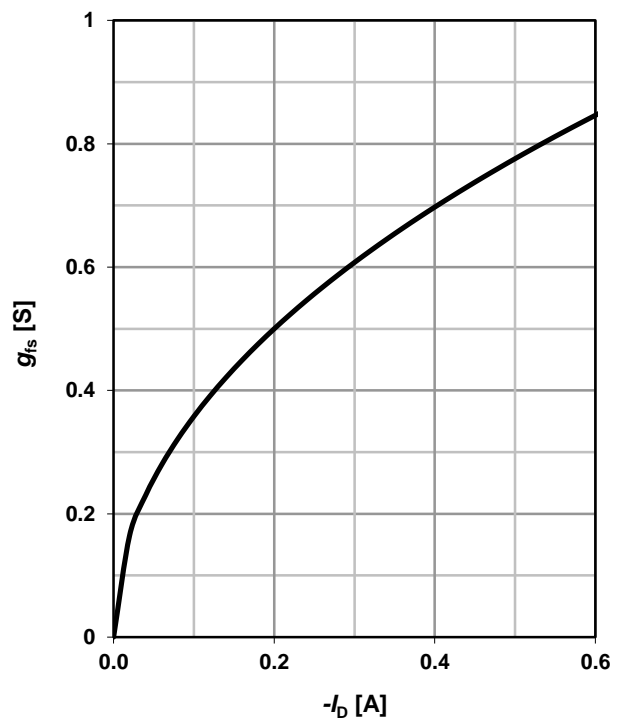

9 Drain-source on-state resistance

$R_{DS(on)}=f(T_j); I_D=-0.36\text{ A}; V_{GS}=-10\text{ V}$

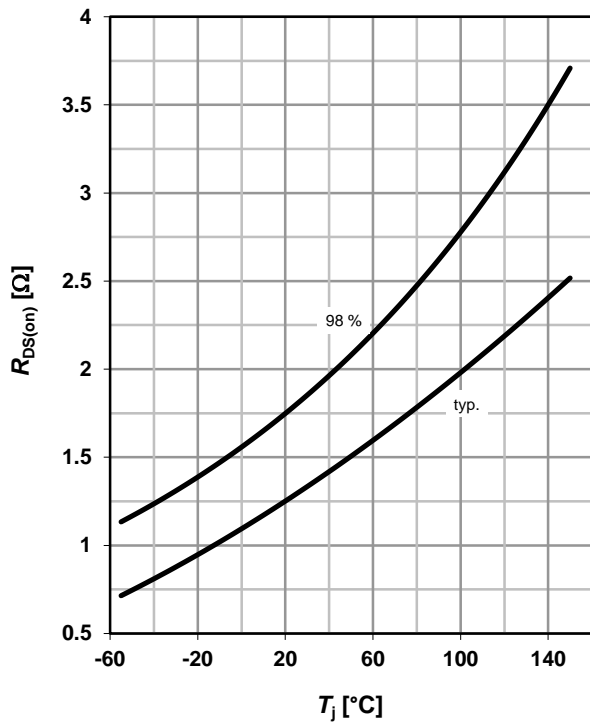

10 Typ. gate threshold voltage

$V_{GS(th)}=f(T_j); V_{GS}=V_{DS}; I_D=-170\ \mu\text{A}$

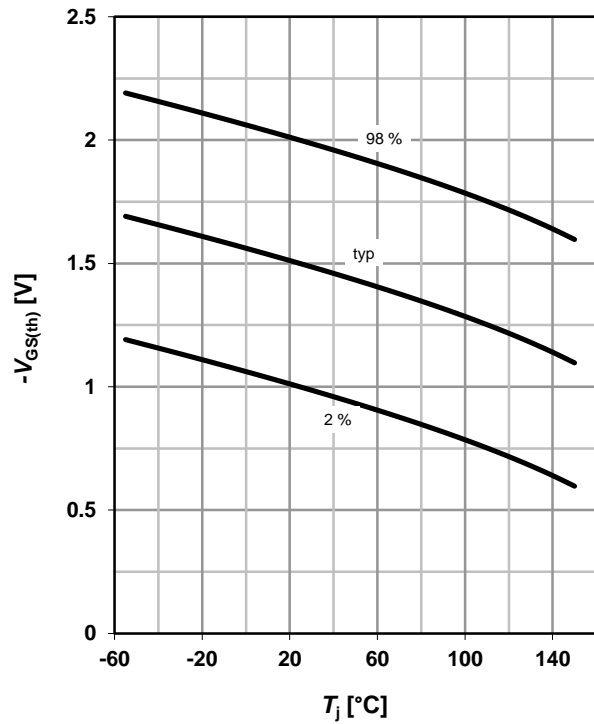

11 Typ. capacitances

$C=f(V_{DS}); V_{GS}=0\text{ V}; f=1\text{ MHz}$

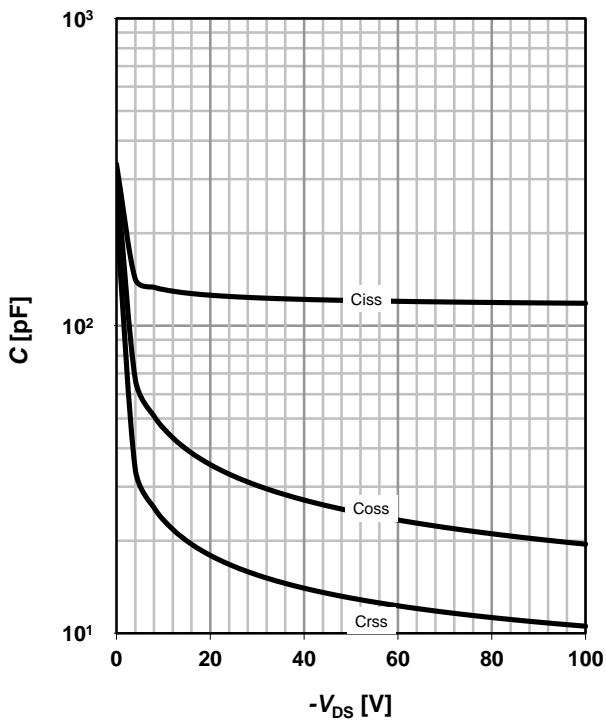

12 Forward characteristics of reverse diode

$I_F=f(V_{SD})$

parameter: T_j

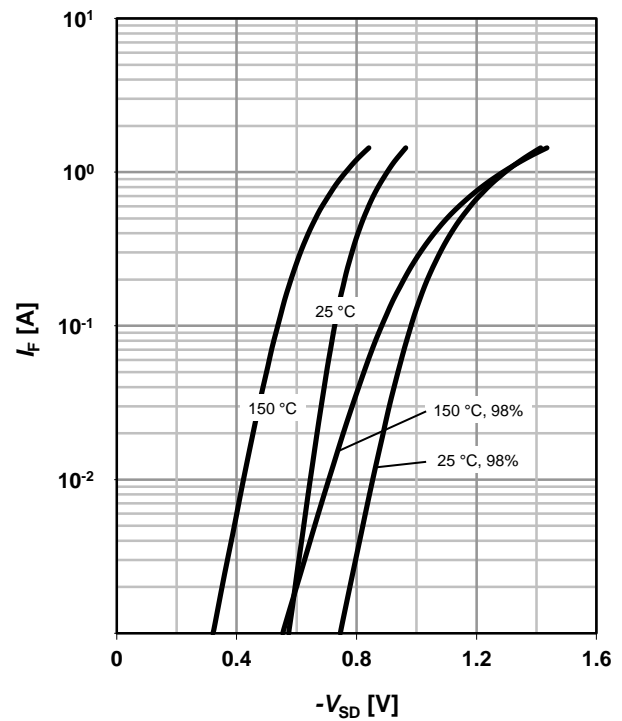

Package Outline

SC-59: Outline

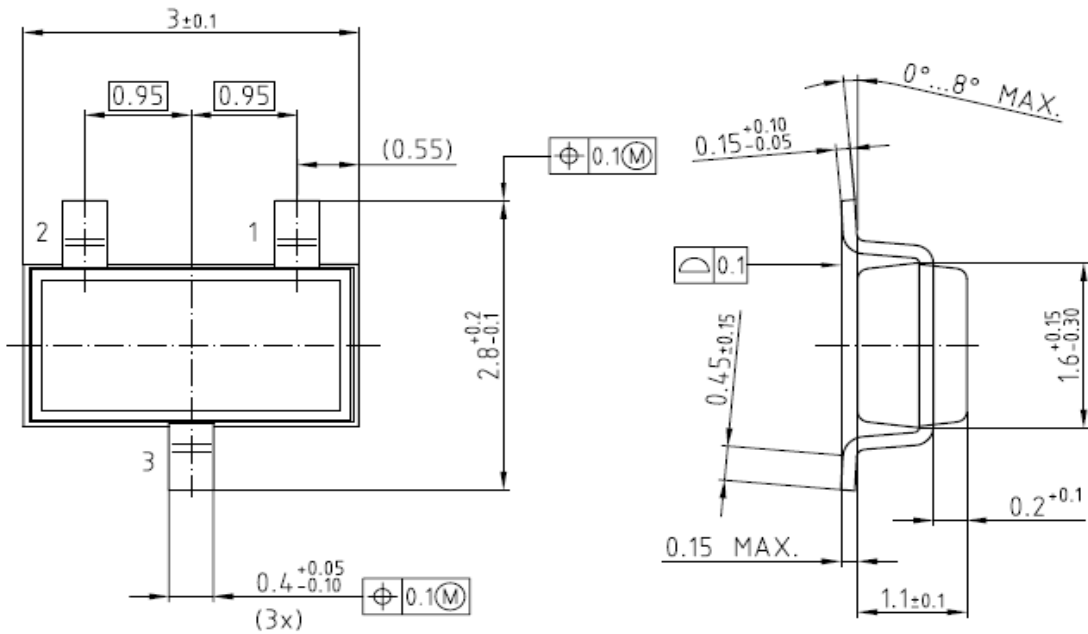

Footprint

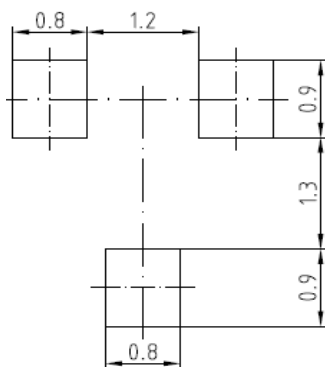

Packaging

Tape

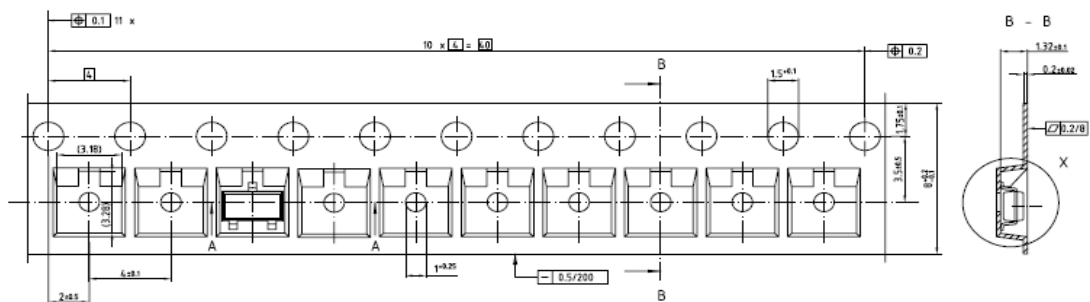

Dimensions in mm

13 Avalanche characteristics

$I_{AS}=f(t_{AV}); R_{GS}=25 \Omega$

parameter: $T_{j(start)}$

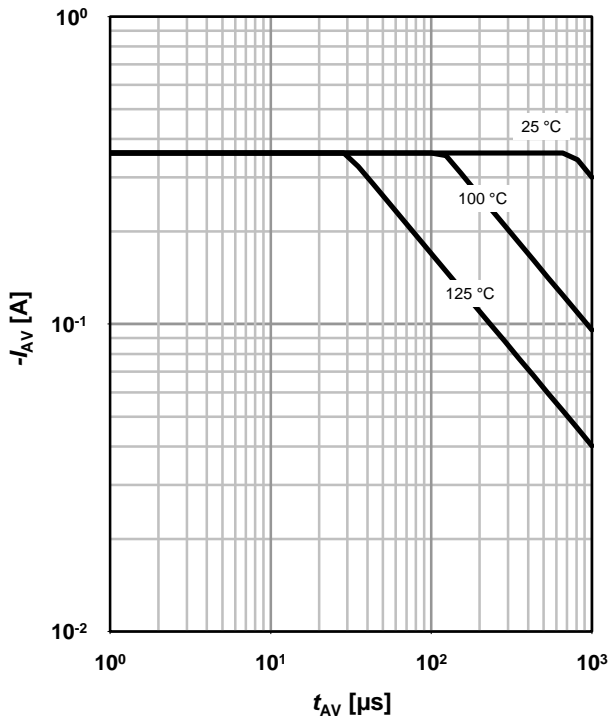

14 Typ. gate charge

$V_{GS}=f(Q_{gate}); I_D=-0.36 \text{ A pulsed}$

parameter: V_{DD}

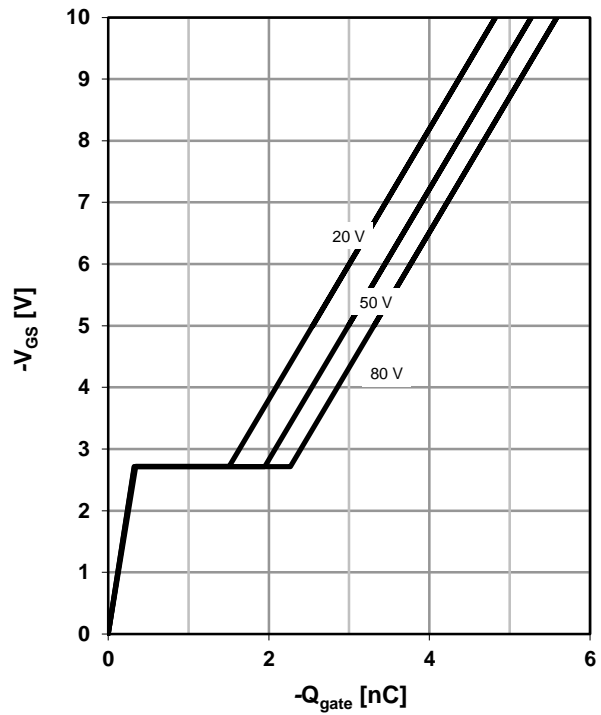

15 Drain-source breakdown voltage

$V_{BR(DSS)}=f(T_j); I_D=-250 \mu\text{A}$

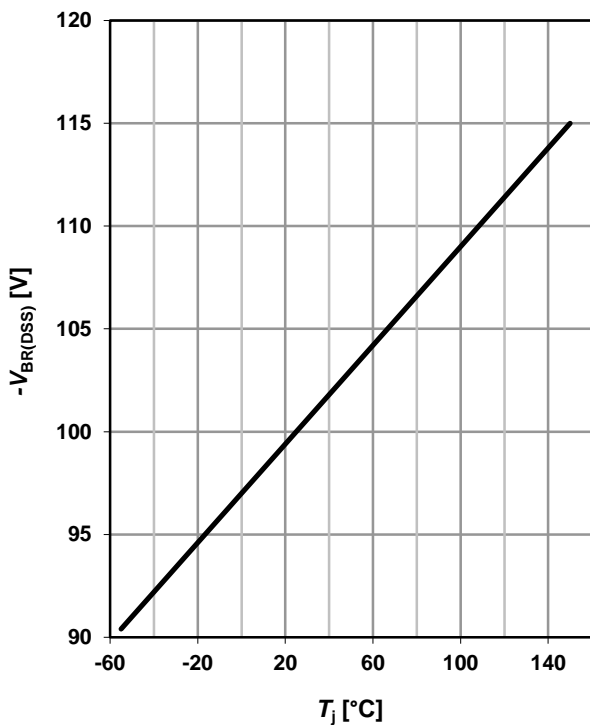

16 Gate charge waveforms

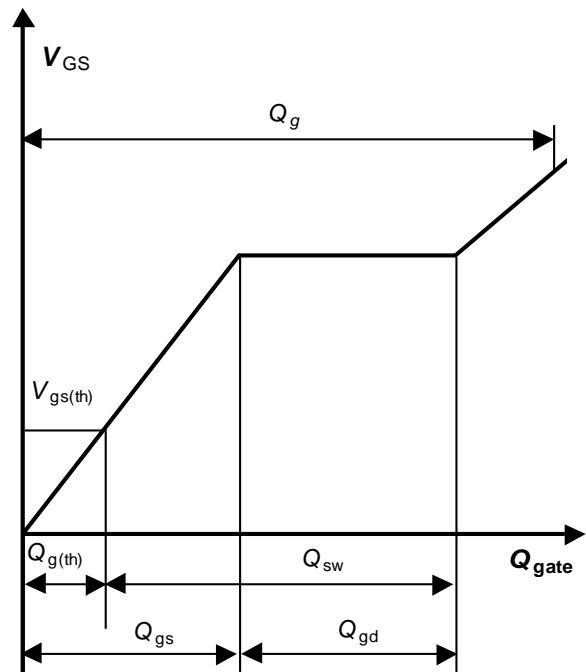

Published by
Infineon Technologies AG
81726 München, Germany
© Infineon Technologies AG 2006.
All Rights Reserved.

Attention please!

The information given in this data sheet shall in no event be regarded as a guarantee of conditions or characteristics ("Beschaffenheitsgarantie"). With respect to any examples or hints given herein, any typical values stated herein and/or any information regarding the application of the device, Infineon Technologies hereby disclaims any and all warranties and liabilities of any kind, including without limitation warranties of non-infringement of intellectual property rights of any third party.

Information

For further information on technology, delivery terms and conditions and prices please contact your nearest Infineon Technologies Office (www.infineon.com).

Warnings

Due to technical requirements components may contain dangerous substances. For information on the types in question please contact your nearest Infineon Technologies Office.

Infineon Technologies Components may only be used in life-support devices or systems with the express written approval of Infineon Technologies, if a failure of such components can reasonably be expected to cause the failure of that life-support device or system, or to affect the safety or effectiveness of that device or system. Life support devices or systems are intended to be implanted in the human body, or to support and/or maintain and sustain and/or protect human life. If they fail, it is reasonable to assume that the health of the user or other persons may be endangered.