

PLEASE CHECK WWW.MOLEX.COM FOR LATEST PART INFORMATION

Part Number: [0039014032](#)
Status: **Active**
Overview: [Mini-Fit Jr.™ Power Connectors](#)
Description: [Mini-Fit Jr.™ Plug Housing, Single Row, 3 Circuits, UL 94V-2, Natural](#)

Documents:

3D Model	Packaging Specification PK-5559-003 (PDF)
Drawing (PDF)	Test Summary TS-5556-002 (PDF)
Product Specification PS-45750-001 (PDF)	RoHS Certificate of Compliance (PDF)
Product Specification PS-5556-001 (PDF)	

Agency Certification

CSA	LR19980
UL	E29179

General

Product Family	Crimp Housings
Series	5559
Application	Power, Wire-to-Board, Wire-to-Wire
Comments	Current = 13A max. per circuit when header is mated to a receptacle loaded with 45750 series terminals crimped to 16 AWG wire. . See Molex product specification PS-45750-001 for additional current derating information.. Glow Wire Equivalent Part.
Overview	Mini-Fit Jr.™ Power Connectors
Product Name	Mini-Fit Jr.™
UPC	800754320634

Physical

Breakaway	No
Circuits (maximum)	3
Color - Resin	Natural
Flammability	94V-2
Gender	Plug
Glow-Wire Compliant	No
Keying to Mating Part	None
Lock to Mating Part	Yes
Material - Resin	Nylon
Net Weight	1.480/g
Number of Rows	1
Packaging Type	Bag
Panel Mount	Yes
Pitch - Mating Interface	4.20mm
Pitch - Termination Interface	4.20mm
Polarized to Mating Part	Yes
Stackable	No
Temperature Range - Operating	-40°C to +105°C

Electrical

Current - Maximum per Contact	13.0A
-------------------------------	-------

Solder Process Data

Lead-freeProcess Capability	N/A
-----------------------------	-----

Material Info

Old Part Number	5559-03P2
-----------------	-----------

Reference - Drawing Numbers

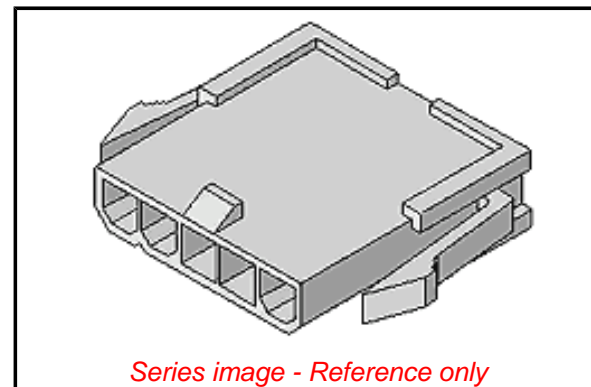

EU ELV

Not Relevant

EU RoHS

Compliant

REACH SVHC

Not Contained Per
-ED/79/2015 (17
December 2015)

Halogen-Free

Status

Low-Halogen

Need more information on product environmental compliance?

Email productcompliance@molex.com
Please visit the [Contact Us](#) section for any non-product compliance questions.

China ROHS

ELV

Green Image
Not Relevant

Search Parts in this Series

[5559 Series](#)

Mates With

[39-01-4030 Receptacle Housing](#)

Use With

[5558 Mini-Fit Jr.™ Male Crimp Terminals.](#)
[30490 Mini-Fit® Male Grounding Crimp Terminals](#)

Packaging Specification
Product Specification
Sales Drawing
Test Summary

PK-5559-003
PS-45750-001, PS-5556-001
SD-5559-03P*
TS-5556-002

This document was generated on 02/29/2016

PLEASE CHECK WWW.MOLEX.COM FOR LATEST PART INFORMATION