

PLEASE CHECK WWW.MOLEX.COM FOR LATEST PART INFORMATION

Part Number: [0399700106](#)
Status: **Active**
Overview: Eurostyle™ Terminal Blocks
Description: 10.16mm Beau™ Eurostyle™ Fixed Mount PCB Terminal Block, High Power 60A, 6 Circuits

Documents:

[3D Model](#) [RoHS Certificate of Compliance \(PDF\)](#)
[Drawing \(PDF\)](#)

Agency Certification

UL E48521

General

Product Family Terminal Blocks
 Series [39970](#)
 Application N/A
 Component Type One Piece
 MolexKits Yes
 Overview [Eurostyle™ Terminal Blocks](#)
 Product Name Eurostyle™ Fixed Mount
 Type Euro Block
 UPC 800753318649

Physical

Circuits (Loaded) 6
 Circuits (maximum) 6
 Color - Resin Black
 Entry Angle Horizontal
 Flammability 94V-0
 Lock to Mating Part None
 Material - Metal Brass, Copper
 Material - Plating Mating Tin
 Material - Plating Termination Tin
 Number of Rows 1
 Orientation Vertical
 PC Tail Length 4.06mm
 PCB Retention None
 Panel Mount No
 Pitch - Mating Interface 10.16mm
 Pitch - Termination Interface 10.16mm
 Plating min - Mating 3.810µm
 Plating min - Termination 3.810µm
 Polarized to Mating Part N/A
 Shrouded Fully
 Stackable No
 Surface Mount Compatible (SMC) No
 Temperature Range - Operating 130°C
 Termination Interface: Style Through Hole
 Wire Size AWG 10, 12, 14, 16, 18, 6, 8
 Wire Size mm² 0.75-10.00

Electrical

Current - Maximum per Contact 60.0A
 Voltage - Maximum 300V

Solder Process Data

Lead-freeProcess Capability WAVE

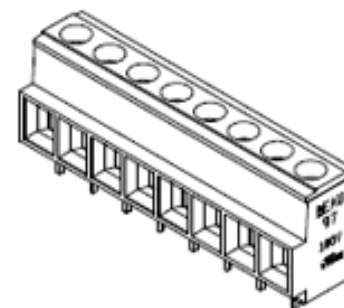

Series image - Reference only

EU ELV

Not Relevant

EU RoHS

Not Reviewed

REACH SVHC

Not Reviewed

Halogen-Free

Status

Not Reviewed

Need more information on product environmental compliance?

Email productcompliance@molex.com
 Please visit the [Contact Us](#) section for any non-product compliance questions.

China ROHS

Not Reviewed

ELV

Not Relevant

Search Parts in this Series

[39970 Series](#)

Material Info

Old Part Number

970506

Reference - Drawing Numbers

Sales Drawing

SD-39970-003

This document was generated on 03/08/2016

PLEASE CHECK WWW.MOLEX.COM FOR LATEST PART INFORMATION