

NCP612, NCV612

100 mA CMOS Low Iq Voltage Regulator in an SC70-5

The NCP612/NCV612 series of fixed output linear regulators are designed for handheld communication equipment and portable battery powered applications which require low quiescent. The NCP612/NCV612 series features an ultra-low quiescent current of 40 μ A. Each device contains a voltage reference unit, an error amplifier, a PMOS power transistor, resistors for setting output voltage, current limit, and temperature limit protection circuits.

The NCP612/NCV612 has been designed to be used with low cost ceramic capacitors. The device is housed in the micro-miniature SC70-5 surface mount package. Standard voltage versions are 1.5, 1.8, 2.5, 2.7, 2.8, 3.0, 3.1, 3.3, 3.7, and 5.0 V.

Features

- Low Quiescent Current of 40 μ A Typical
- Low Dropout Voltage of 230 mV at 100 mA and 3.0 V V_{out}
- Low Output Voltage Option
- Output Voltage Accuracy of 2.0%
- Temperature Range of -40°C to 85°C (NCP612)
Temperature Range of -40°C to 125°C (NCV612)
- NCV Prefix for Automotive and Other Applications Requiring Unique Site and Control Change Requirements; AEC-Q100 Qualified and PPAP Capable
- These are Pb-Free Devices

Typical Applications

- Cellular Phones
- Battery Powered Consumer Products
- Hand-Held Instruments
- Camcorders and Cameras

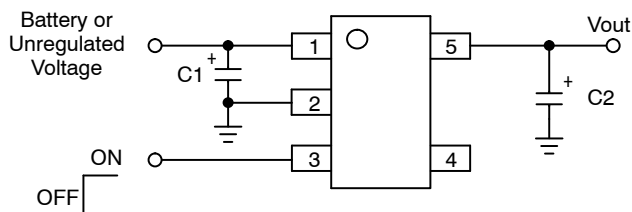

This device contains 86 active transistors

Figure 1. Typical Application Diagram



ON Semiconductor®

<http://onsemi.com>



SC70-5
CASE 419A

PIN CONNECTIONS

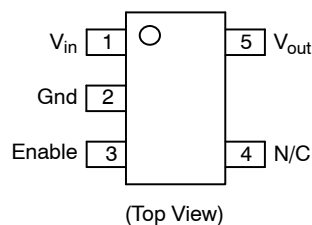

MARKING DIAGRAM

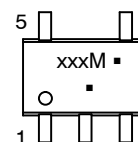

xxx = Specific Device Code
M = Date Code*
▪ = Pb-Free Package

(Note: Microdot may be in either location)

ORDERING INFORMATION

See detailed ordering and shipping information in the package dimensions section on page 8 of this data sheet.

NCP612, NCV612

PIN FUNCTION DESCRIPTION

Pin No.	Pin Name	Description
1	V _{in}	Positive power supply input voltage.
2	Gnd	Power supply ground.
3	Enable	This input is used to place the device into low-power standby. When this input is pulled low, the device is disabled. If this function is not used, Enable should be connected to V _{in} .
4	N/C	No internal connection.
5	V _{out}	Regulated output voltage.

MAXIMUM RATINGS

Rating	Symbol	Value	Unit
Input Voltage	V _{in}	0 to 6.0	V
Enable Voltage	Enable	-0.3 to V _{in} + 0.3	V
Output Voltage	V _{out}	-0.3 to V _{in} + 0.3	V
Power Dissipation and Thermal Characteristics Power Dissipation Thermal Resistance, Junction-to-Ambient	P _D R _{θJA}	Internally Limited 300	W °C/W
Operating Junction Temperature	T _J	+150	°C
Operating Ambient Temperature	T _A	-40 to +125	°C
Storage Temperature	T _{stg}	-55 to +150	°C

Stresses exceeding Maximum Ratings may damage the device. Maximum Ratings are stress ratings only. Functional operation above the Recommended Operating Conditions is not implied. Extended exposure to stresses above the Recommended Operating Conditions may affect device reliability.

1. This device series contains ESD protection and exceeds the following tests:

Human Body Model 2000 V per MIL-STD-883, Method 3015

Machine Model Method 200 V

2. Latch-up capability (85°C) ± 200 mA DC with trigger voltage.

ELECTRICAL CHARACTERISTICS

(V_{in} = V_{out(nom.)} + 1.0 V, V_{enable} = V_{in}, C_{in} = 1.0 μF, C_{out} = 1.0 μF, T_J = 25°C, unless otherwise noted.)

Characteristic	Symbol	Min	Typ	Max	Unit
Output Voltage (T _A = 25°C, I _{out} = 10 mA)	V _{out}				V
1.5 V		1.455	1.5	1.545	
1.8 V		1.746	1.8	1.854	
2.5 V		2.425	2.5	2.575	
2.7 V		2.646	2.7	2.754	
2.8 V		2.744	2.8	2.856	
3.0 V		2.940	3.0	3.060	
3.1 V		3.038	3.1	3.162	
3.3 V		3.234	3.3	3.366	
3.7 V		3.626	3.7	3.774	
5.0 V		4.900	5.0	5.100	
Output Voltage (T _A = -40°C to 85°C, I _{out} = 10 mA)	V _{out}				V
1.5 V		1.455	1.5	1.545	
1.8 V		1.746	1.8	1.854	
2.5 V		2.425	2.5	2.575	
2.7 V		2.619	2.7	2.781	
2.8 V		2.716	2.8	2.884	
3.0 V		2.910	3.0	3.090	
3.1 V		3.007	3.1	3.193	
3.3 V		3.201	3.3	3.399	
3.7 V		3.626	3.7	3.774	
5.0 V		4.900	5.0	5.100	

NCP612, NCV612

ELECTRICAL CHARACTERISTICS (continued)

($V_{in} = V_{out(nom.)} + 1.0\text{ V}$, $V_{enable} = V_{in}$, $C_{in} = 1.0\ \mu\text{F}$, $C_{out} = 1.0\ \mu\text{F}$, $T_J = 25^\circ\text{C}$, unless otherwise noted.)

Characteristic	Symbol	Min	Typ	Max	Unit
Output Voltage ($T_A = -40^\circ\text{C}$ to 125°C , $I_{out} = 10\text{ mA}$) NCV612 Only 1.5 V 1.8 V 2.5 V 2.7 V 2.8 V 3.0 V 3.1 V 3.3 V 5.0 V	V_{out}	1.440 1.728 2.400 2.592 2.688 2.880 2.976 3.201 4.850	1.5 1.8 2.5 2.7 2.8 3.0 3.1 3.3 5.0	1.560 1.872 2.600 2.808 2.912 3.120 3.224 3.399 5.150	V
Output Voltage ($T_A = -40^\circ\text{C}$ to 85°C , $I_{out} = 100\text{ mA}$) 1.5 V 1.8 V 2.5 V 2.7 V 2.8 V 3.0 V 3.1 V 3.3 V 3.7 V 5.0 V	V_{out}	1.440 1.728 2.400 2.592 2.688 2.880 2.976 3.201 3.589 4.850	1.5 1.8 2.5 2.7 2.8 3.0 3.1 3.3 3.7 5.0	1.560 1.872 2.600 2.808 2.912 3.120 3.224 3.399 3.811 5.150	V
Line Regulation ($I_{out} = 10\text{ mA}$) 1.5 V–4.4 V ($V_{in} = V_{out(nom.)} + 1.0\text{ V}$ to 6.0 V) 4.5 V–5.0 V ($V_{in} = 5.5\text{ V}$ to 6.0 V)	Reg_{line}	– –	1.0 1.0	3.0 3.0	mV/V
Load Regulation ($I_{out} = 1.0\text{ mA}$ to 100 mA)	Reg_{load}	–	0.3	0.8	mV/mA
Output Current ($V_{out} = (V_{out}$ at $I_{out} = 100\text{ mA}) - 3\%$) 1.5 V–3.9 V ($V_{in} = V_{out(nom.)} + 2.0\text{ V}$) 4.0 V–5.0 V ($V_{in} = 6.0\text{ V}$)	$I_{o(nom.)}$	100 100	200 200	– –	mA
Dropout Voltage ($T_A = -40^\circ\text{C}$ to 85°C , $I_{out} = 100\text{ mA}$, Measured at $V_{out(nom.)} - 3.0\%$) 1.5 V 1.8 V 2.5 V 2.7 V 2.8 V 3.0 V 3.1 V 3.3 V 3.7 V 5.0 V	$V_{in} - V_{out}$	– – – – – – – – – –	530 420 270 270 250 230 210 200 180 160	680 560 380 380 380 380 380 380 380 300	mV
Ground Current (Enable Input = V_{in} , $I_{out} = 1.0\text{ mA}$ to $I_{o(nom.)}$)	I_{GND}	–	40	90	μA
Quiescent Current ($T_A = -40^\circ\text{C}$ to 85°C) (Enable Input = 0 V) (Enable Input = V_{in} , $I_{out} = 1.0\text{ mA}$ to $I_{o(nom.)}$)	I_Q	– –	0.03 40	1.0 90	μA
Output Short Circuit Current ($V_{out} = 0\text{ V}$) 1.5 V–3.9 V ($V_{in} = V_{out(nom.)} + 2.0\text{ V}$) 4.0 V–5.0 V ($V_{in} = 6.0\text{ V}$)	$I_{out(max)}$	150 150	300 300	600 600	mA
Output Voltage Noise ($f = 100\text{ Hz}$ to 100 kHz) $I_{out} = 30\text{ mA}$, $C_{out} = 1\ \mu\text{F}$	V_n	–	100	–	μV_{rms}
Enable Input Threshold Voltage (Voltage Increasing, Output Turns On, Logic High) (Voltage Decreasing, Output Turns Off, Logic Low)	$V_{th(en)}$	0.95 –	– –	– 0.3	V
Output Voltage Temperature Coefficient	T_C	–	± 100	–	ppm/ $^\circ\text{C}$

3. Maximum package power dissipation limits must be observed.

$$PD = \frac{T_J(max) - T_A}{R_{\theta JA}}$$

4. Low duty cycle pulse techniques are used during testing to maintain the junction temperature as close to ambient as possible.

NCP612, NCV612

TYPICAL CHARACTERISTICS

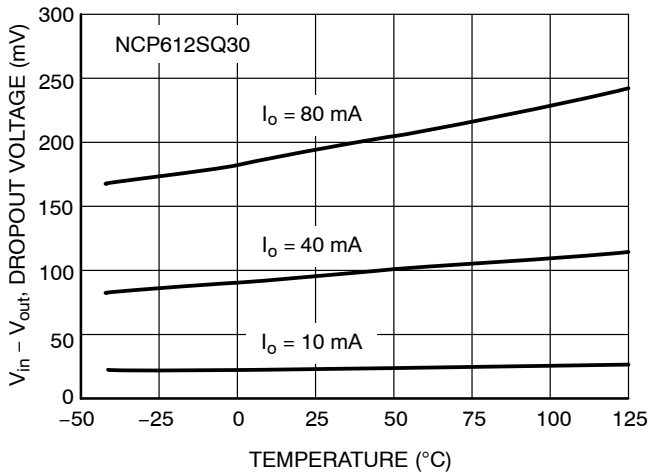

Figure 2. Dropout Voltage vs. Temperature

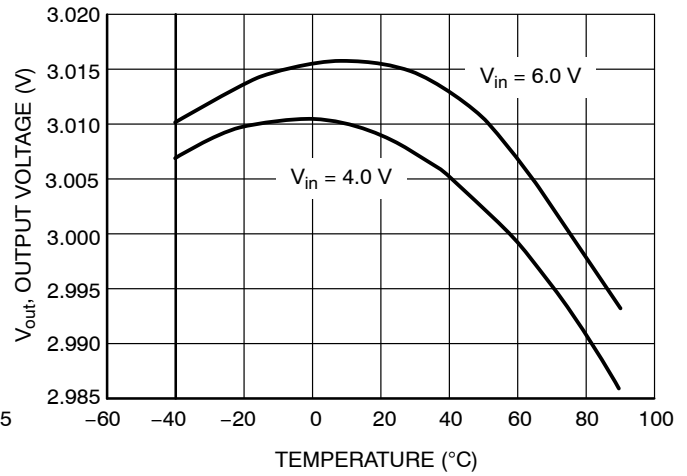

Figure 3. Output Voltage vs. Temperature

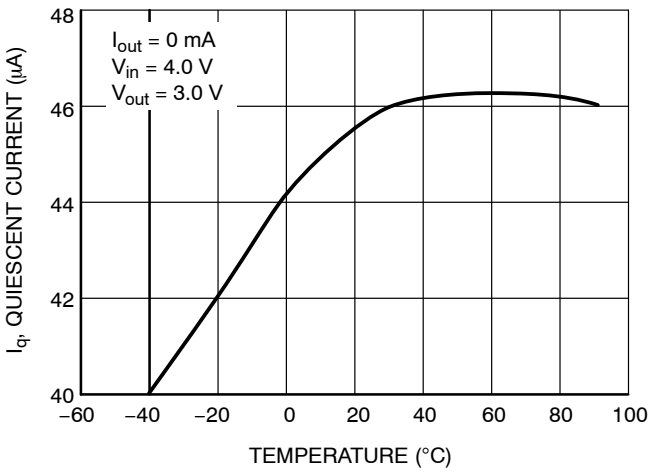

Figure 4. Quiescent Current vs. Temperature

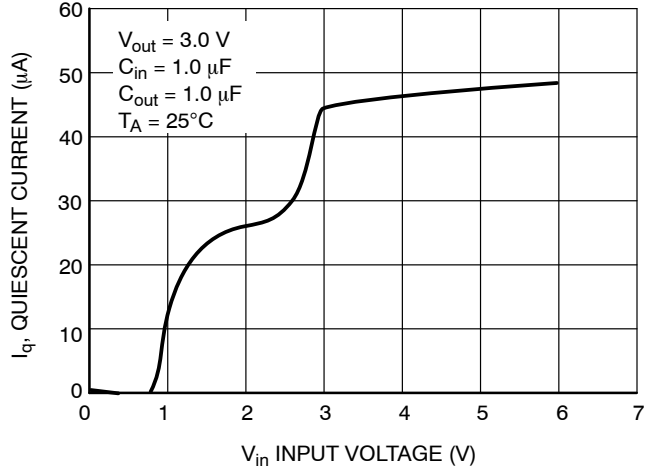

Figure 5. Quiescent Current vs. Input Voltage

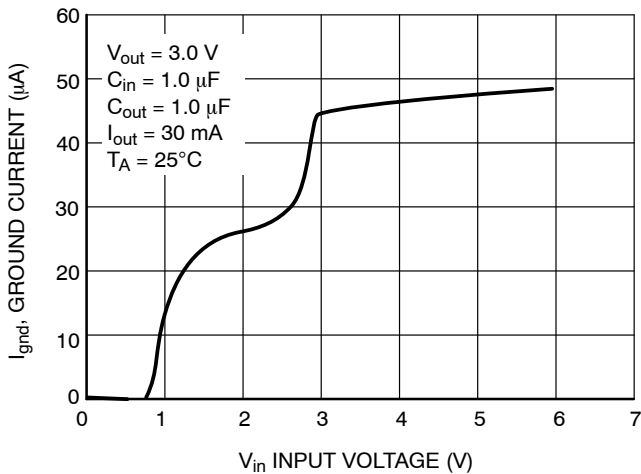

Figure 6. Ground Pin Current vs. Input Voltage

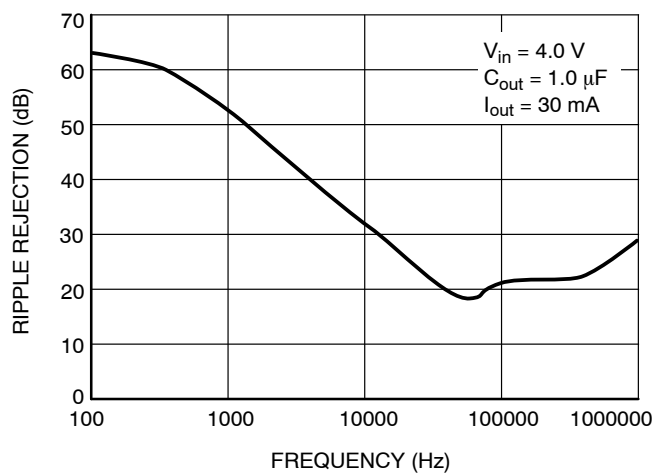

Figure 7. Ripple Rejection vs. Frequency

NCP612, NCV612

TYPICAL CHARACTERISTICS

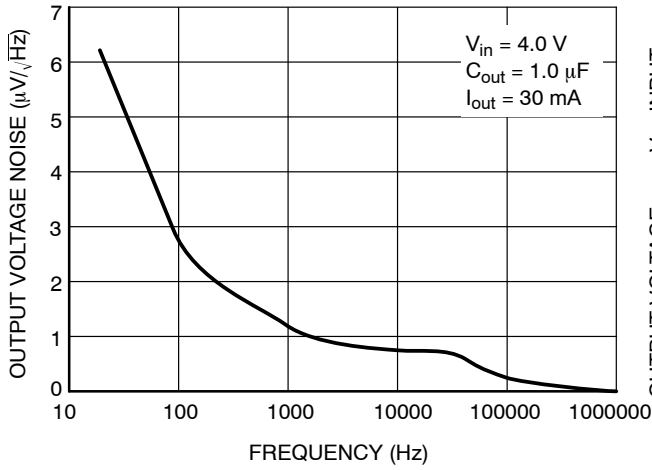

Figure 8. Output Noise Density

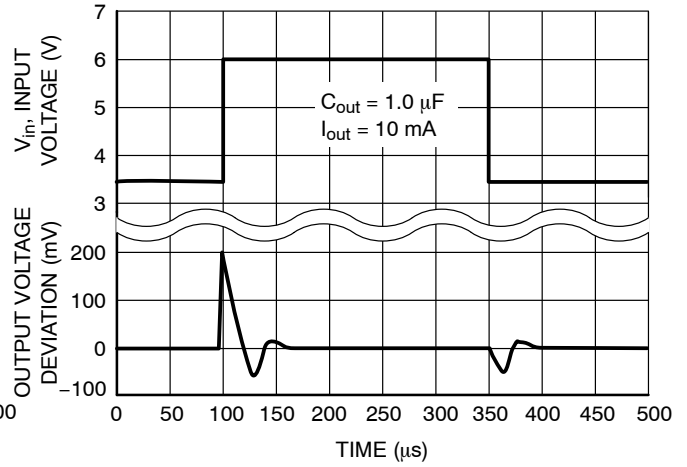

Figure 9. Line Transient Response

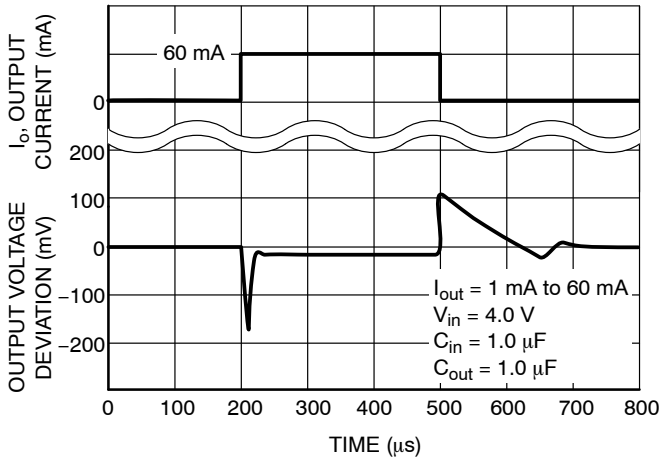

Figure 10. Load Transient Response

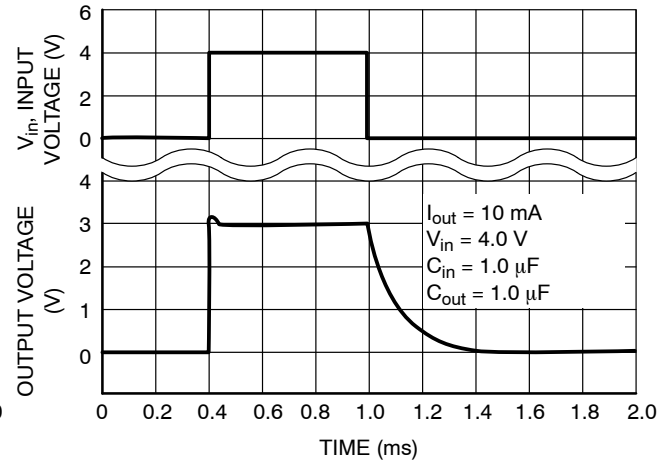

Figure 11. Turn-on Response

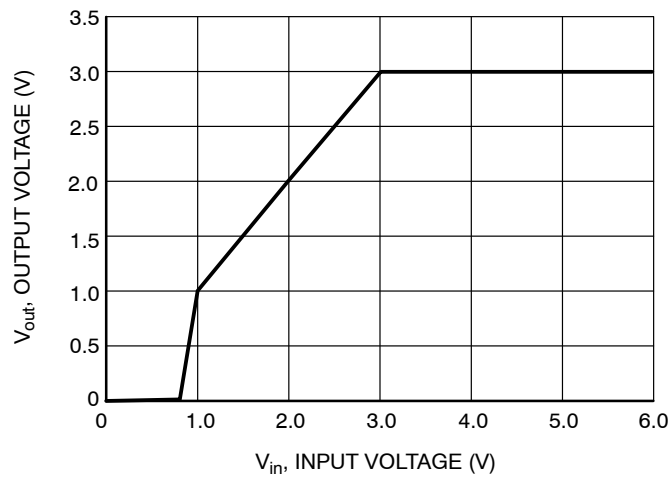

Figure 12. Output Voltage vs. Input Voltage

DEFINITIONS

Load Regulation

The change in output voltage for a change in output current at a constant temperature.

Dropout Voltage

The input/output differential at which the regulator output no longer maintains regulation against further reductions in input voltage. Measured when the output drops 3.0% below its nominal. The junction temperature, load current, and minimum input supply requirements affect the dropout level.

Maximum Power Dissipation

The maximum total dissipation for which the regulator will operate within its specifications.

Quiescent Current

The quiescent current is the current which flows through the ground when the LDO operates without a load on its output: internal IC operation, bias, etc. When the LDO becomes loaded, this term is called the Ground current. It is actually the difference between the input current (measured through the LDO input pin) and the output current.

Line Regulation

The change in output voltage for a change in input voltage. The measurement is made under conditions of low dissipation or by using pulse technique such that the average chip temperature is not significantly affected.

Line Transient Response

Typical over and undershoot response when input voltage is excited with a given slope.

Thermal Protection

Internal thermal shutdown circuitry is provided to protect the integrated circuit in the event that the maximum junction temperature is exceeded. When activated at typically 160°C, the regulator turns off. This feature is provided to prevent failures from accidental overheating.

Maximum Package Power Dissipation

The maximum power package dissipation is the power dissipation level at which the junction temperature reaches its maximum operating value, i.e. 150°C. Depending on the ambient power dissipation and thus the maximum available output current.

NCP612, NCV612

APPLICATIONS INFORMATION

A typical application circuit for the NCP612/NCV612 is shown in Figure 1, front page.

Input Decoupling (C1)

A 1.0 μF capacitor either ceramic or tantalum is recommended and should be connected close to the NCP612/NCV612 package. Higher values and lower ESR will improve the overall line transient response.

TDK capacitor: C2012X5R1C105K, or C1608X5R1A105K

Output Decoupling (C2)

The NCP612/NCV612 is a stable regulator and does not require any specific Equivalent Series Resistance (ESR) or a minimum output current. Capacitors exhibiting ESRs ranging from a few $\text{m}\Omega$ up to $5.0\ \Omega$ can thus safely be used. The minimum decoupling value is 1.0 μF and can be augmented to fulfill stringent load transient requirements. The regulator accepts ceramic chip capacitors as well as tantalum capacitors. Larger values improve noise rejection and load regulation transient response.

TDK capacitor: C2012X5R1C105K, C1608X5R1A105K, or C3216X7R1C105K

Enable Operation

The enable pin will turn on the regulator when pulled high and turn off the regulator when pulled low. These limits of threshold are covered in the electrical specification section of this data sheet. If the enable is not used then the pin should be connected to V_{in} .

Hints

Please be sure the V_{in} and Gnd lines are sufficiently wide. When the impedance of these lines is high, there is a chance to pick up noise or cause the regulator to malfunction.

Set external components, especially the output capacitor, as close as possible to the circuit, and make leads as short as possible.

Thermal

As power across the NCP612/NCV612 increases, it might become necessary to provide some thermal relief. The maximum power dissipation supported by the device is dependent upon board design and layout. Mounting pad configuration on the PCB, the board material and also the ambient temperature effect the rate of temperature rise for the part. This is stating that when the NCP612/NCV612 has good thermal conductivity through the PCB, the junction temperature will be relatively low with high power dissipation applications.

The maximum dissipation the package can handle is given by:

$$P_D = \frac{T_{J(\text{max})} - T_A}{R_{\theta JA}}$$

If junction temperature is not allowed above the maximum 125°C , then the NCP612/NCV612 can dissipate up to 330 mW @ 25°C .

The power dissipated by the NCP612/NCV612 can be calculated from the following equation:

$$P_{\text{tot}} = [V_{\text{in}} * I_{\text{gnd}}] + [V_{\text{in}} - V_{\text{out}}] * I_{\text{out}}$$

or

$$V_{\text{inMAX}} = \frac{P_{\text{tot}} + V_{\text{out}} * I_{\text{out}}}{I_{\text{gnd}} + I_{\text{out}}}$$

If an 100 mA output current is needed then the ground current from the data sheet is 40 μA . For an NCP612/NCV612 (3.0 V), the maximum input voltage will then be 6.0 V (Limited by maximum input voltage).

NCP612, NCV612

ORDERING INFORMATION

Device	Nominal Output Voltage	Marking	Package	Shipping [†]
NCP612SQ15T1G	1.5	LHO	SC70-5 (Pb-Free)	3000 Units/Tape & Reel
NCP612SQ15T2G				
NCP612SQ18T1G	1.8	LHP		
NCP612SQ18T2G				
NCP612SQ25T1G	2.5	LHQ		
NCP612SQ25T2G				
NCP612SQ27T1G	2.7	LHR		
NCP612SQ27T2G				
NCP612SQ28T1G	2.8	LHS		
NCP612SQ28T2G				
NCP612SQ30T1G	3.0	LHT		
NCP612SQ30T2G				
NCP612SQ31T1G	3.1	LHU		
NCP612SQ31T2G				
NCP612SQ33T1G	3.3	LHV		
NCP612SQ33T2G				
NCP612SQ37T1G	3.7	LKH		
NCP612SQ37T2G				
NCP612SQ50T1G	5.0	LHW		
NCP612SQ50T2G				
NCV612SQ15T1G*	1.5	LHO		
NCV612SQ15T2G*				
NCV612SQ18T1G*	1.8	LHP		
NCV612SQ18T2G*				
NCV612SQ25T1G*	2.5	LHQ		
NCV612SQ25T2G*				
NCV612SQ27T1G*	2.7	LHR		
NCV612SQ27T2G*				
NCV612SQ28T1G*	2.8	LHS		
NCV612SQ28T2G*				
NCV612SQ30T1G*	3.0	LHT		
NCV612SQ30T2G*				
NCV612SQ31T1G*	3.1	LHU		
NCV612SQ31T2G*				
NCV612SQ33T1G*	3.3	LHV		
NCV612SQ33T2G*				
NCV612SQ50T1G*	5.0	LHW		
NCV612SQ50T2G*				

[†]For information on tape and reel specifications, including part orientation and tape sizes, please refer to our Tape and Reel Packaging Specification Brochure, BRD8011/D.

*NCV Prefix for Automotive and Other Applications Requiring Unique Site and Control Change Requirements; AEC-Q100 Qualified and PPAP Capable.

NCP612, NCV612

PACKAGE DIMENSIONS

SC-88A
(SC-70-5/SOT-353)
CASE 419A-02
ISSUE L

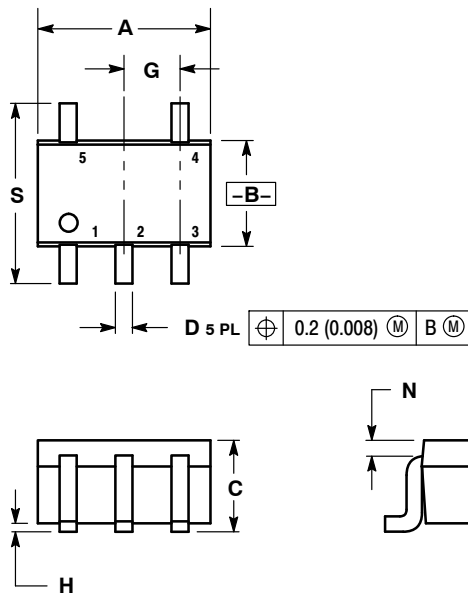

NOTES:

1. DIMENSIONING AND TOLERANCING PER ANSI Y14.5M, 1982.
2. CONTROLLING DIMENSION: INCH.
3. 419A-01 OBSOLETE. NEW STANDARD 419A-02.
4. DIMENSIONS A AND B DO NOT INCLUDE MOLD FLASH, PROTRUSIONS, OR GATE BURRS.

DIM	INCHES		MILLIMETERS	
	MIN	MAX	MIN	MAX
A	0.071	0.087	1.80	2.20
B	0.045	0.053	1.15	1.35
C	0.031	0.043	0.80	1.10
D	0.004	0.012	0.10	0.30
G	0.026 BSC		0.65 BSC	
H	---	0.004	---	0.10
J	0.004	0.010	0.10	0.25
K	0.004	0.012	0.10	0.30
N	0.008 REF		0.20 REF	
S	0.079	0.087	2.00	2.20

SOLDER FOOTPRINT

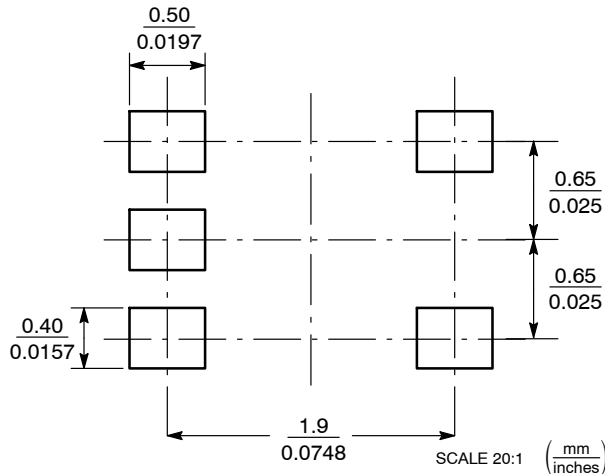

ON Semiconductor and are registered trademarks of Semiconductor Components Industries, LLC (SCILLC). SCILLC owns the rights to a number of patents, trademarks, copyrights, trade secrets, and other intellectual property. A listing of SCILLC's product/patent coverage may be accessed at www.onsemi.com/site/pdf/Patent-Marking.pdf. SCILLC reserves the right to make changes without further notice to any products herein. SCILLC makes no warranty, representation or guarantee regarding the suitability of its products for any particular purpose, nor does SCILLC assume any liability arising out of the application or use of any product or circuit, and specifically disclaims any and all liability, including without limitation special, consequential or incidental damages. "Typical" parameters which may be provided in SCILLC data sheets and/or specifications can and do vary in different applications and actual performance may vary over time. All operating parameters, including "Typicals" must be validated for each customer application by customer's technical experts. SCILLC does not convey any license under its patent rights nor the rights of others. SCILLC products are not designed, intended, or authorized for use as components in systems intended for surgical implant into the body, or other applications intended to support or sustain life, or for any other application in which the failure of the SCILLC product could create a situation where personal injury or death may occur. Should Buyer purchase or use SCILLC products for any such unintended or unauthorized application, Buyer shall indemnify and hold SCILLC and its officers, employees, subsidiaries, affiliates, and distributors harmless against all claims, costs, damages, and expenses, and reasonable attorney fees arising out of, directly or indirectly, any claim of personal injury or death associated with such unintended or unauthorized use, even if such claim alleges that SCILLC was negligent regarding the design or manufacture of the part. SCILLC is an Equal Opportunity/Affirmative Action Employer. This literature is subject to all applicable copyright laws and is not for resale in any manner.

PUBLICATION ORDERING INFORMATION

LITERATURE FULFILLMENT:

Literature Distribution Center for ON Semiconductor
P.O. Box 5163, Denver, Colorado 80217 USA
Phone: 303-675-2175 or 800-344-3860 Toll Free USA/Canada
Fax: 303-675-2176 or 800-344-3867 Toll Free USA/Canada
Email: orderlit@onsemi.com

N. American Technical Support: 800-282-9855 Toll Free
USA/Canada
Europe, Middle East and Africa Technical Support:
Phone: 421 33 790 2910
Japan Customer Focus Center
Phone: 81-3-5817-1050

ON Semiconductor Website: www.onsemi.com

Order Literature: <http://www.onsemi.com/orderlit>

For additional information, please contact your local Sales Representative