

# PCMFxUSB30 series

Common-mode EMI filter for differential channels with integrated ESD protection

Rev. 1 — 01 April 2016

Product data sheet

## 1. Product profile

### 1.1 General description

Common-mode ElectroMagnetic Interference (EMI) filters with integrated ElectroStatic Discharge (ESD) protection for one, two and three differential channels. The devices are designed to provide low insertion loss for differential high-speed signals on each channel while unwanted common-mode signals are attenuated.

Each differential channel incorporates two signal lines that are coupled by integrated coils. Diodes provide protection to downstream components from ESD voltages up to  $\pm 15$  kV on each signal line.

Table 1. Product overview

Type number	Number of channels	Package Name
PCMF1USB30	1	WLCSP5
PCMF2USB30	2	WLCSP10
PCMF3USB30	3	WLCSP15

### 1.2 Features and benefits

- One, two and three differential channels common-mode EMI filters with integrated ESD protection
- ESD protection up to  $\pm 15$  kV contact discharge according to IEC 61000-4-2
- Superior common-mode suppression over a wide frequency range
- Superior RF performance compared to other integrated filters or discrete filters with external ESD protection
- Extremely high symmetry between line pairs
- Industry-standard Wafer Level Chip Scale Packages: WLCSP5, 10 and 15 for smaller footprint

### 1.3 Applications

- Smartphone, cellular and cordless phone
- Tablet PC and Mobile Internet Device (MID)
- USB 3.1, USB 2.0, HDMI 2.0, HDMI 1.4
- MIPI M-PHY and D-PHY as used in Camera Serial Interface (CSI) and Display Serial Interface (DSI)
- General-purpose EMI and Radio-Frequency Interference (RFI) filter and downstream ESD protection



## 2. Pinning information

Table 2. Pinning

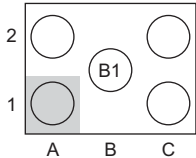
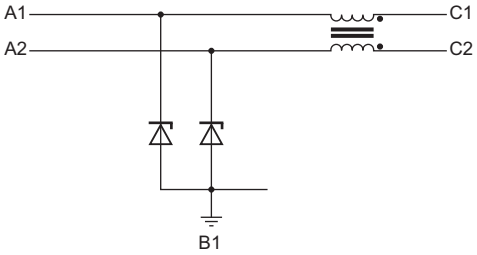
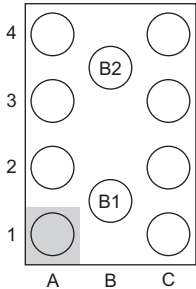
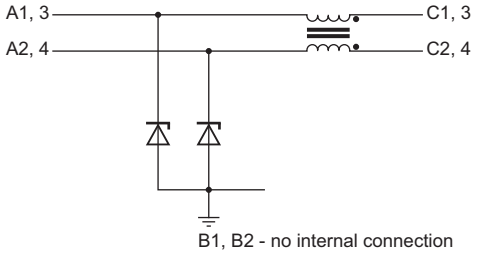
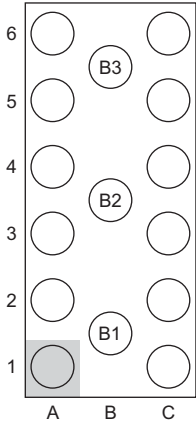
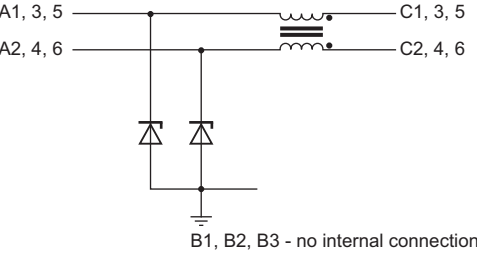
Pin	Symbol	Description	Simplified outline	Graphic symbol
<b>PCMF1USB30 (WLCSP5_2-1-2)</b>				
A1	CH1_IN+	channel 1+, external	 <p>Transparent top view <b>WLCSP5_2-1-2</b></p>	 <p style="text-align: right;"><i>aaa-019784</i></p>
A2	CH1_IN-	channel 1-, external		
B1	GND_CH1	ground channel 1		
C1	CH1_OUT+	channel 1+, internal		
C2	CH1_OUT-	channel 1-, internal		
<b>PCMF2USB30 (WLCSP10_4-2-4)</b>				
A1	CH1_IN+	channel 1+, external	 <p>Transparent top view <b>WLCSP10_4-2-4</b></p>	 <p style="text-align: right;"><i>aaa-019785</i></p>
A2	CH1_IN-	channel 1-, external		
A3	CH2_IN+	channel 2+, external		
A4	CH2_IN-	channel 2-, external		
B1	GND_CH1	ground channel 1		
B2	GND_CH2	ground channel 2		
C1	CH1_OUT+	channel 1+, internal		
C2	CH1_OUT-	channel 1-, internal		
C3	CH2_OUT+	channel 2+, internal		
C4	CH2_OUT-	channel 2-, internal		
<b>PCMF3USB30 (WLCSP15_6-3-6)</b>				
A1	CH1_IN+	channel 1+, external	 <p>Transparent top view <b>WLCSP15_6-3-6</b></p>	 <p style="text-align: right;"><i>aaa-019786</i></p>
A2	CH1_IN-	channel 1-, external		
A3	CH2_IN+	channel 2+, external		
A4	CH2_IN-	channel 2-, external		
A5	CH3_IN+	channel 3+, external		
A6	CH3_IN-	channel 3-, external		
B1	GND_CH1	ground channel 1		
B2	GND_CH2	ground channel 2		
B3	GND_CH3	ground channel 3		
C1	CH1_OUT+	channel 1+, internal		
C2	CH1_OUT-	channel 1-, internal		
C3	CH2_OUT+	channel 2+, internal		
C4	CH2_OUT-	channel 2-, internal		
C5	CH3_OUT+	channel 3+, internal		
C6	CH3_OUT-	channel 3-, internal		

### 3. Ordering information

Table 3. Ordering information

Type number	Package		
	Name	Description	Version
PCMF1USB30	WLCSP5	wafer level chip-size package; 5 bumps (2-1-2)	PCMF1USB30
PCMF2USB30	WLCSP10	wafer level chip-size package; 10 bumps (4-2-4)	PCMF2USB30
PCMF3USB30	WLCSP15	wafer level chip-size package; 15 bumps (6-3-6)	PCMF3USB30

### 4. Marking

Table 4. Marking codes

Type number	Marking code
PCMF1USB30	PF1S
PCMF2USB30	PF2S
PCMF3USB30	PF3S

### 5. Limiting values

Table 5. Limiting values

In accordance with the Absolute Maximum Rating System (IEC 60134).

Symbol	Parameter	Conditions	Min	Max	Unit
$V_I$	input voltage		-0.5	5	V
$V_{ESD}$	electrostatic discharge voltage	IEC 61000-4-2, level 4; all input pins to ground			
		contact discharge	-15	15	kV
		air discharge	-15	15	kV
		IEC 61000-4-2, level 4; all output pins to ground			
		contact discharge	-2	2	kV
		air discharge	-2	2	kV
$I_{PPM}$	rated peak pulse current	$t_p = 8/20 \mu s$	-7	7	A
$T_{stg}$	storage temperature		-40	+125	°C
$T_{amb}$	ambient temperature		-40	+85	°C

## 6. Characteristics

### 6.1 Channel characteristics

**Table 6. Channel characteristics**

$T_{amb} = 25\text{ }^{\circ}\text{C}$  unless otherwise specified.

Symbol	Parameter	Conditions	Min	Typ	Max	Unit
$R_{S(ch)}$	channel series resistance	single line; input to output	-	3	-	$\Omega$
$C_d$	diode capacitance	$f = 1\text{ MHz}$ ; $V_I = 2.5\text{ V}$ [1]	-	0.25	-	pF
$I_{RM}$	reverse leakage current	per line; $V_I = 5\text{ V}$	-	-	100	nA
$V_{BR}$	breakdown voltage	$I_R = 1\text{ mA}$	6	9	-	V
$V_F$	forward voltage	$I_F = 10\text{ mA}$	-	0.8	-	V
$R_{dyn}$	dynamic resistance	TLP [2]				
		positive transient	-	0.14	-	$\Omega$
		negative transient	-	0.14	-	$\Omega$
		surge [3]				
		positive transient	-	0.22	-	$\Omega$
		negative transient	-	0.22	-	$\Omega$

[1] This parameter is guaranteed by design.

[2] 100 ns Transmission Line Pulse (TLP); 50 W; pulser at 70 ns to 90 ns.

[3] According to IEC 61000-4-5 (8/20 ms).

### 6.2 Frequency characteristics

**Table 7. Frequency characteristics**

Symbol	Parameter	Conditions	Min	Typ	Max	Unit
<b>Common mode: <math>S_{21cc}</math></b>						
$\alpha_{il}$	insertion loss	[1]				
		$f = 800\text{ MHz}$	-	-12	-	dB
		$f = 2.6\text{ GHz}$	-	-38	-	dB
		$f = 5\text{ GHz}$	-	-18	-	dB
<b>Differential mode: <math>S_{21dd}</math></b>						
$\alpha_{il}$	insertion loss	$f = 1\text{ MHz}$ [1]	-	0.3	-	dB
$f_{-3dB}$	cut-off frequency	[1]	-	6	-	GHz

[1] Normalized to attenuation at 1 MHz.

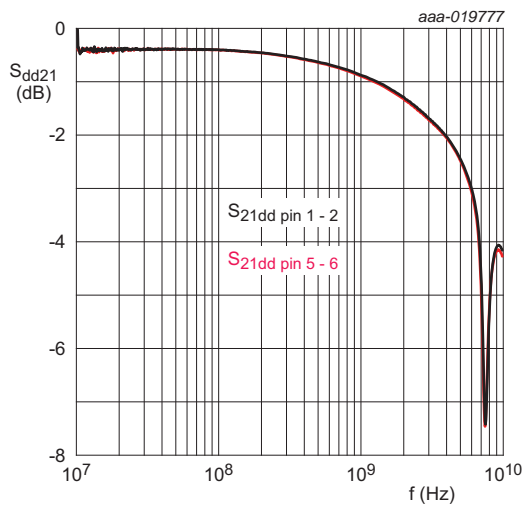

Fig 1. Differential-mode insertion loss; typical values

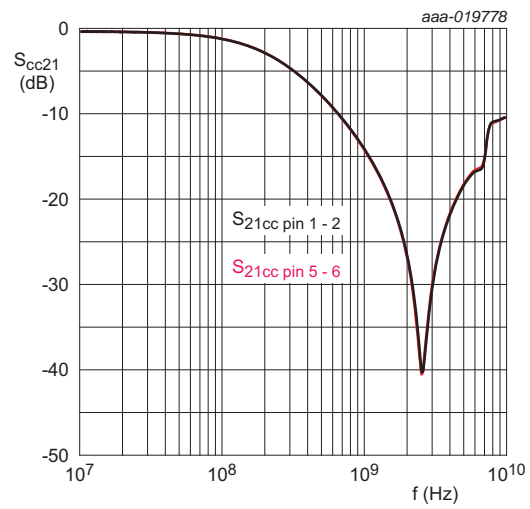

Fig 2. Common-mode insertion loss; typical values

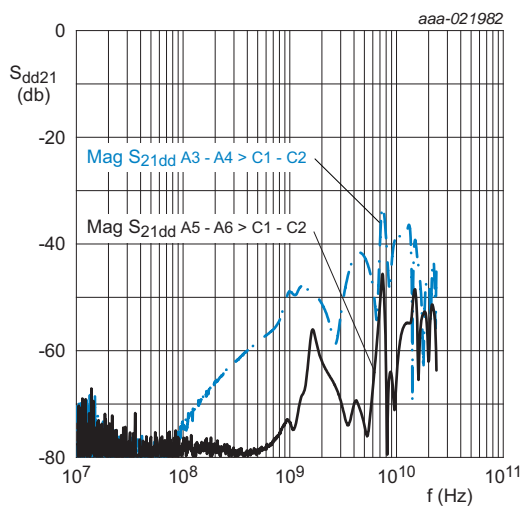
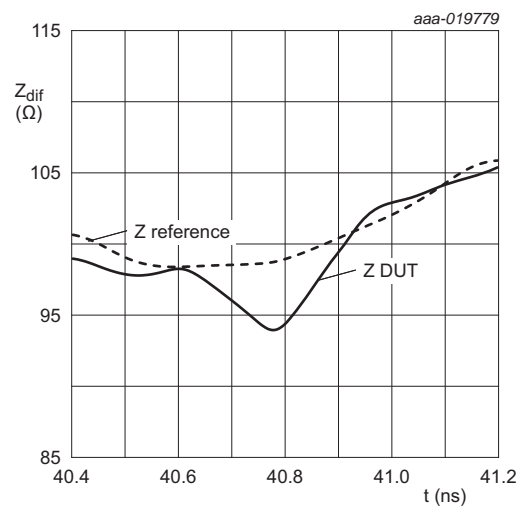
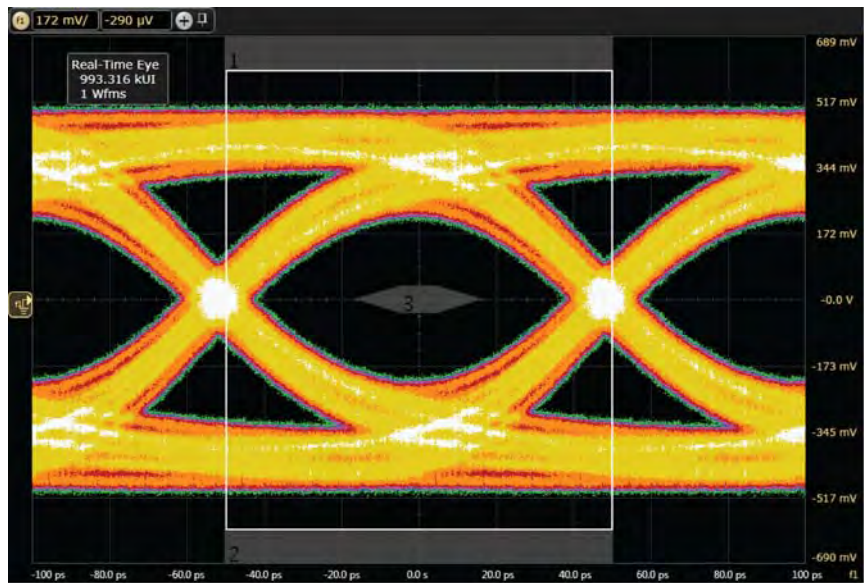

Fig 3. Differential crosstalk; typical values



$t_r = 200$  ps

Fig 4. Differential Time Domain Reflectometer (TDR) plot; typical values



aaa-022137

Data rate: 10 Gbit/s  
 Vertical scale: 173 mV/div  
 Horizontal scale: 20 ps/div

Fig 5. USB 3.1 eye diagram, test board with PCMF2USB30; typical values

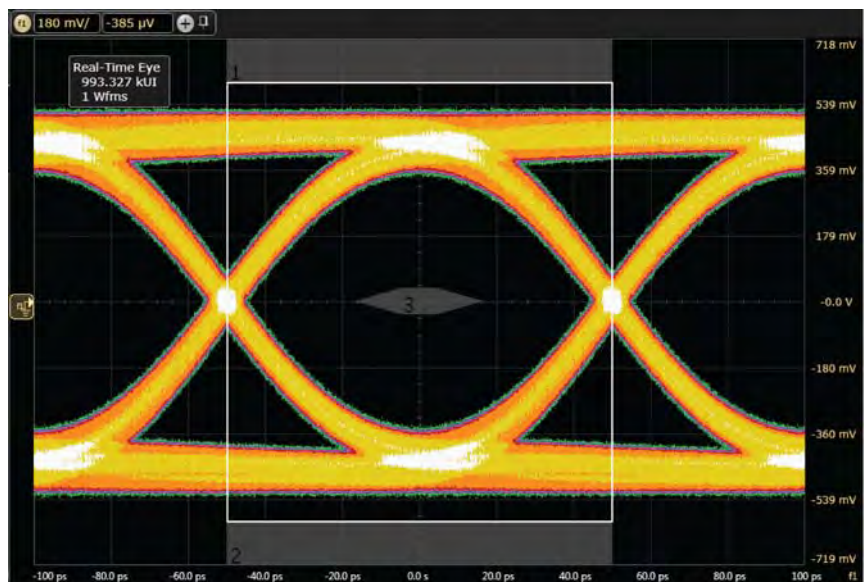

aaa-022138

Data rate: 10 Gbit/s  
 Vertical scale: 180 mV/div  
 Horizontal scale: 20 ps/div

Fig 6. USB 3.1 eye diagram, test board without device; typical values



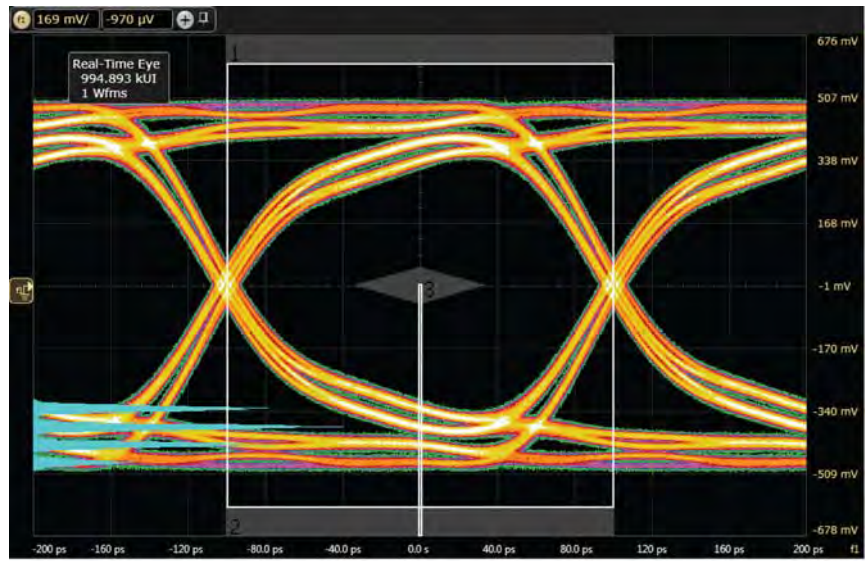

Data rate: 5 Gbit/s  
 Vertical scale: 169 mV/div  
 Horizontal scale: 40 ps/div

Fig 7. USB 3.1 eye diagram, test board with PCMF2USB30; typical values



Data rate: 5 Gbit/s  
 Vertical scale: 179 mV/div  
 Horizontal scale: 40 ps/div

Fig 8. USB 3.1 eye diagram, test board without device; typical values

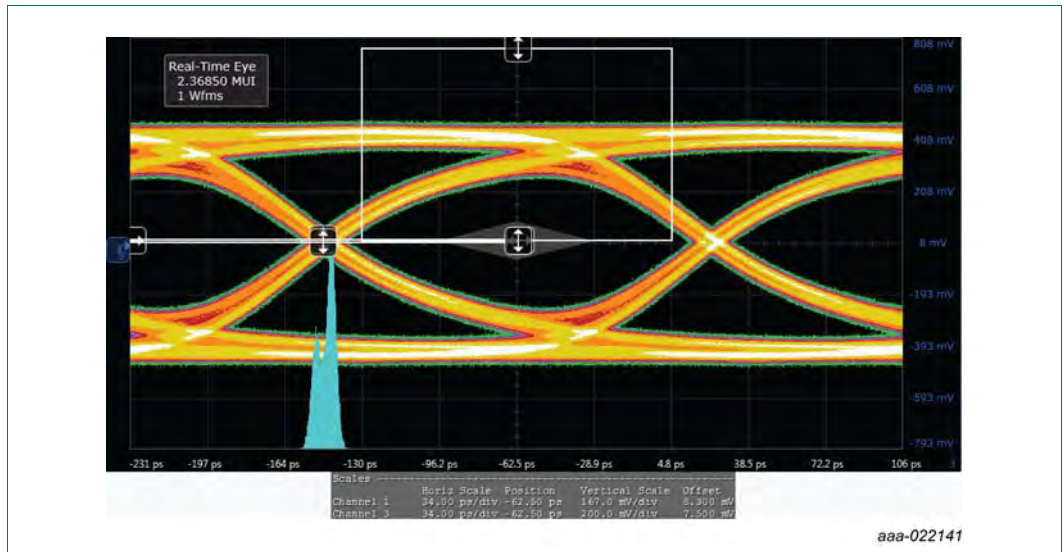

Test frequency: 148.5 MHz  
 Differential swing voltage: 861 mV  
 Horizontal scale: 34 ps/div

Fig 9. HDMI 2.0 eye diagram TP1, test board with PCMF2USB30; typical values

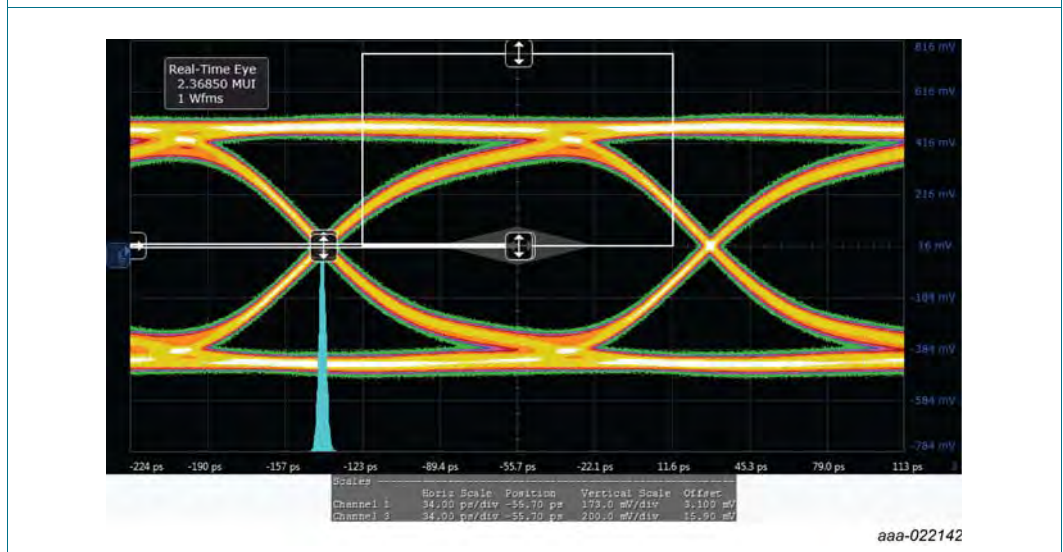

Test frequency: 148.5 MHz  
 Differential swing voltage: 917 mV  
 Horizontal scale: 34 ps/div

Fig 10. HDMI 2.0 eye diagram TP1, test board without device; typical values



Common-mode EMI filter for differential channels with ESD protection

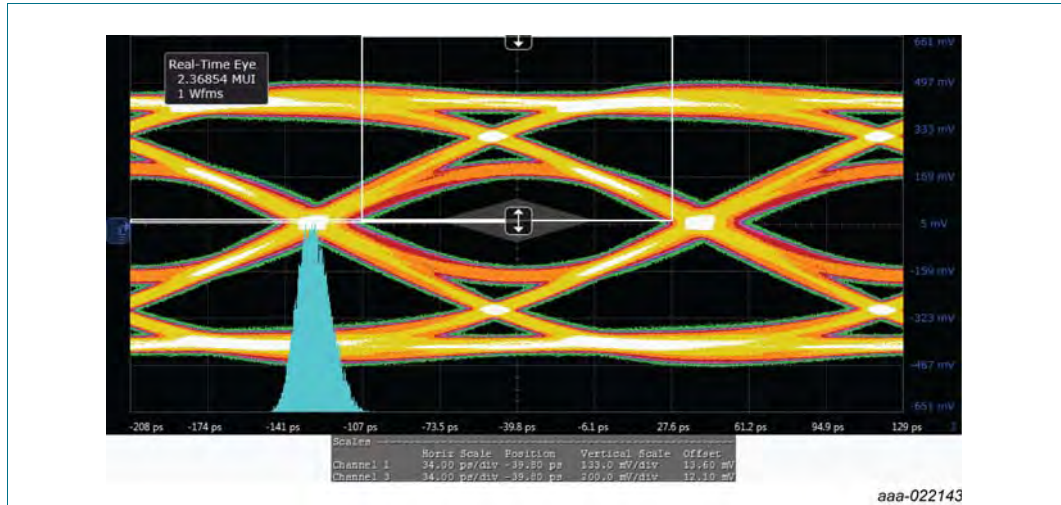

Test frequency: 148.5 MHz  
 Differential swing voltage: 849 mV  
 Horizontal scale: 34 ps/div

**Remark:** Measured at Test Point 2 (TP2) worst cable emulator, reference cable equalizer and worst case positive skew.

Fig 11. HDMI 2.0 eye diagram TP2, test board with PCMF2USB30; typical values

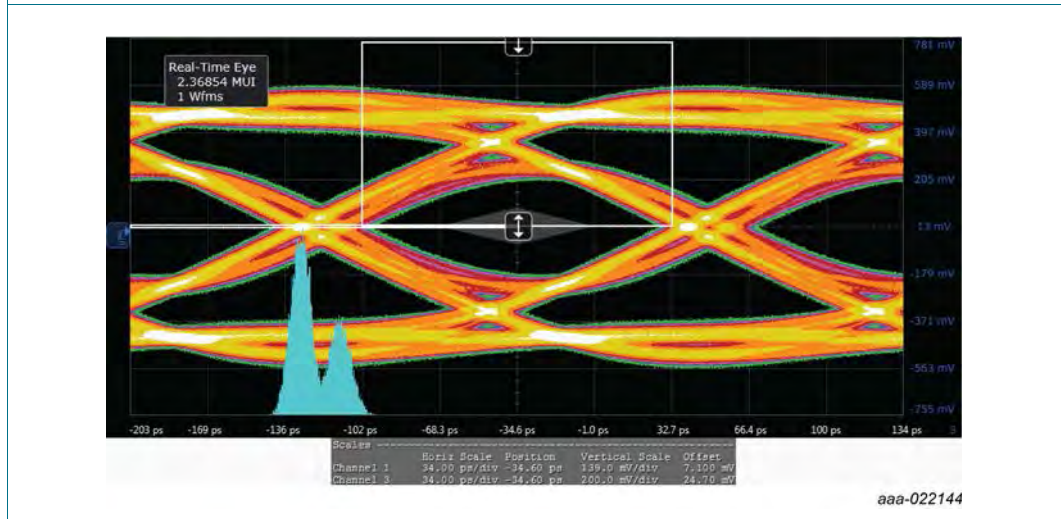

Test frequency: 148.5 MHz  
 Differential swing voltage: 909 mV  
 Horizontal scale: 34 ps/div

**Remark:** Measured at Test Point 2 (TP2) worst cable emulator, reference cable equalizer and worst case positive skew.

Fig 12. HDMI 2.0 eye diagram TP2, test board without device; typical values

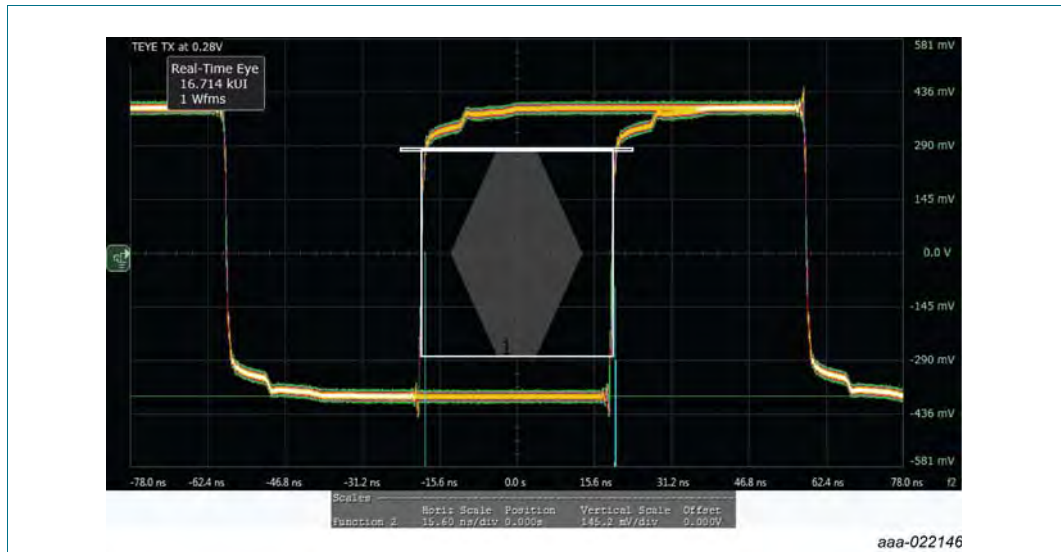

Fig 13. MIPI M-PHY PWM-TX transmitter eye opening at 140 mV, test board with PCMF2USB30; typical values

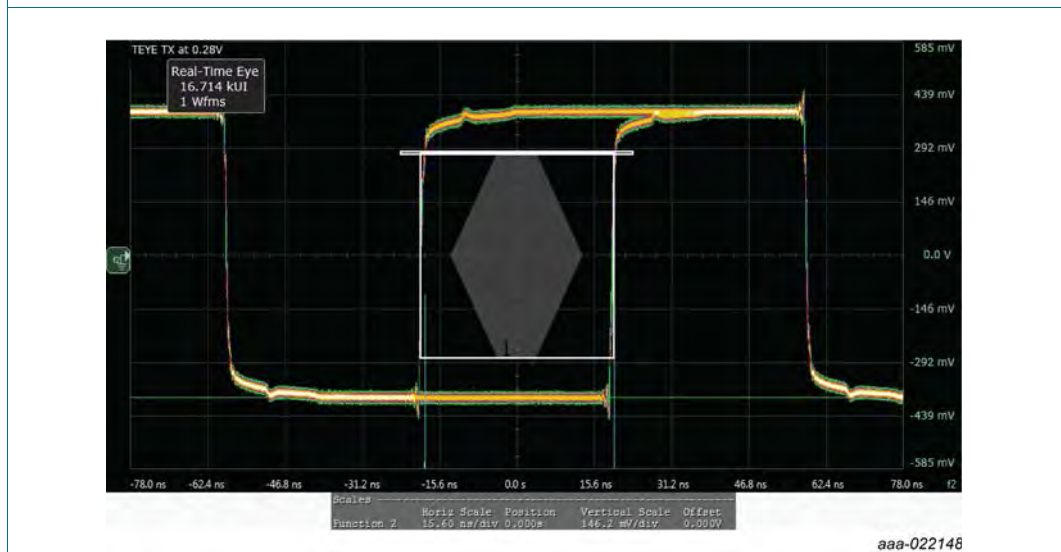
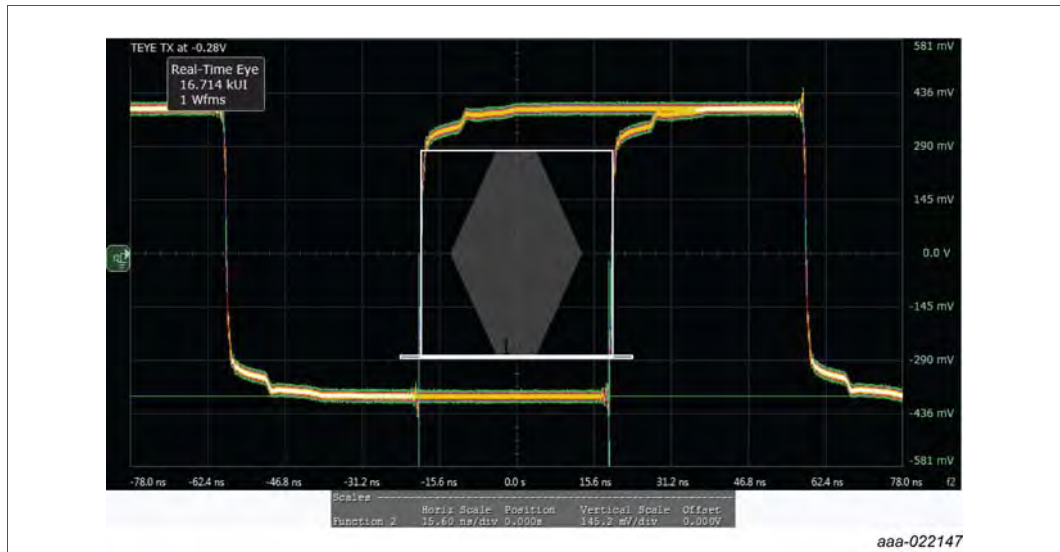
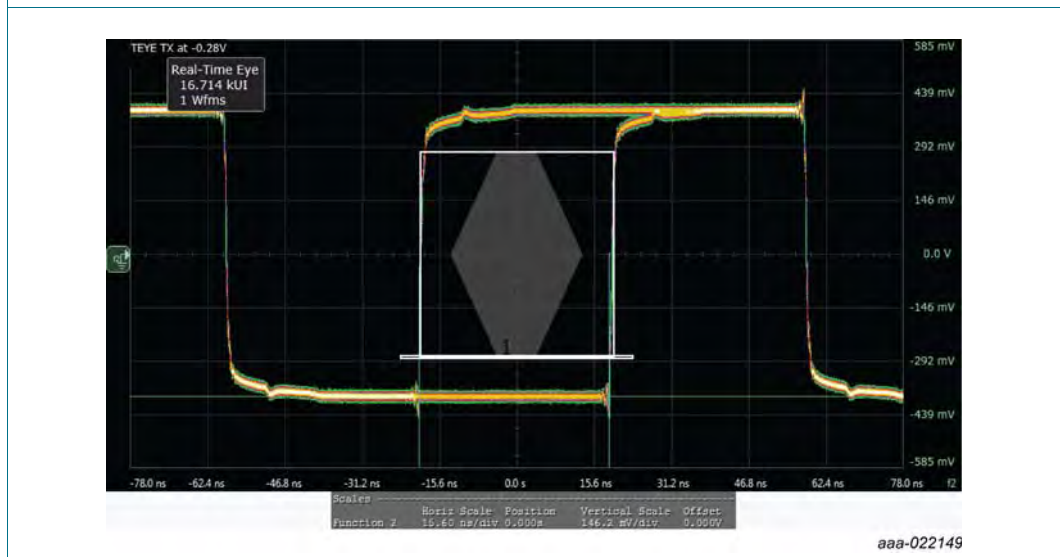

Fig 14. MIPI M-PHY PWM-TX transmitter eye opening at 140 mV, test board without device; typical values



Vertical scale: 145 mV/div  
Horizontal scale: 15.6 ns/div

Fig 15. MIPI M-PHY PWM-TX transmitter eye opening at -140 mV, test board with PCMF2USB30; typical values



Vertical scale: 146 mV/div  
Horizontal scale: 15.6 ns/div

Fig 16. MIPI M-PHY PWM-TX transmitter eye opening at -140 mV, test board without device; typical values

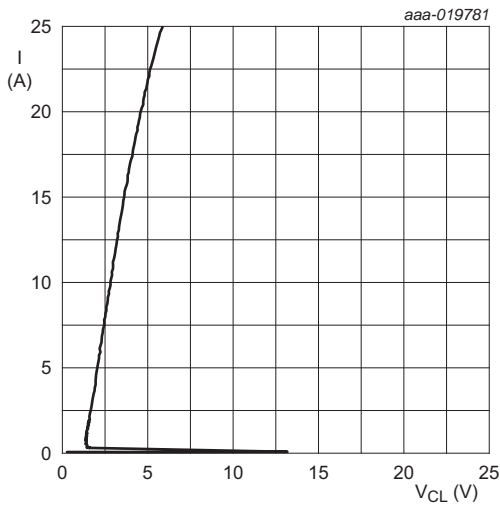

Transmission Line Pulse (TLP) = 100 ns;  
 $t_r = 1$  ns

**Fig 17. Dynamic resistance with positive clamping; typical values**

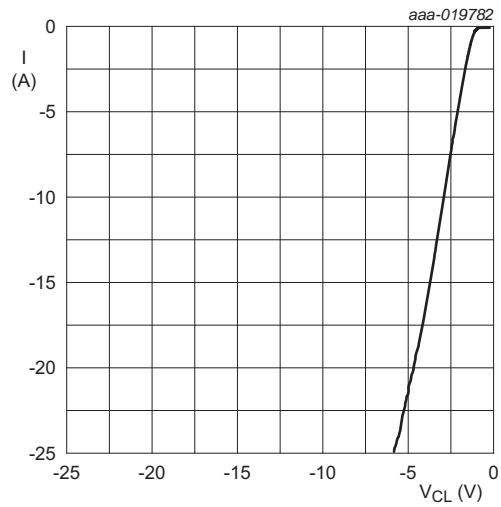

Transmission Line Pulse (TLP) = 100 ns;  
 $t_r = 1$  ns

**Fig 18. Dynamic resistance with negative clamping; typical values**

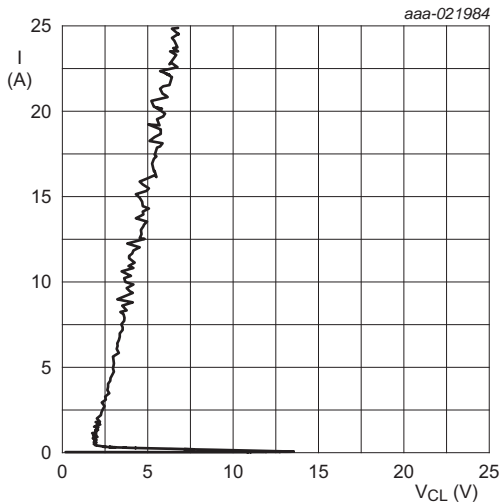

Very-Fast Transmission Line Pulse (VF-TLP) = 5 ns;  
 $t_r = 600$  ps

**Fig 19. Dynamic resistance with positive clamping; typical values**

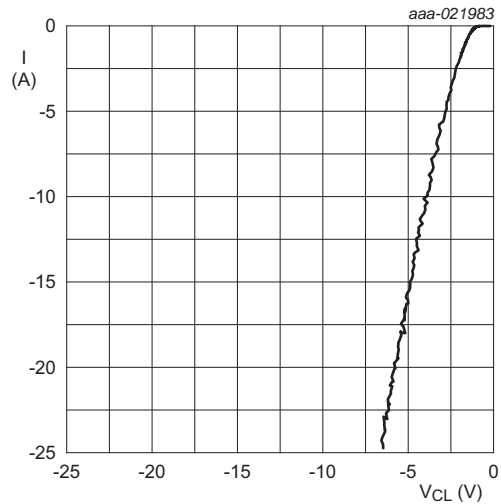

Very-Fast Transmission Line Pulse (VF-TLP) = 5 ns;  
 $t_r = 600$  ps

**Fig 20. Dynamic resistance with negative clamping; typical values**

The device uses an advanced clamping structure showing a negative dynamic resistance. This snapback behavior strongly reduces the clamping voltage to the system behind the ESD protection during an ESD event. Do not connect unlimited DC current sources to the data lines to avoid keeping the ESD protection device in snapback state after exceeding breakdown voltage (due to an ESD pulse for instance).

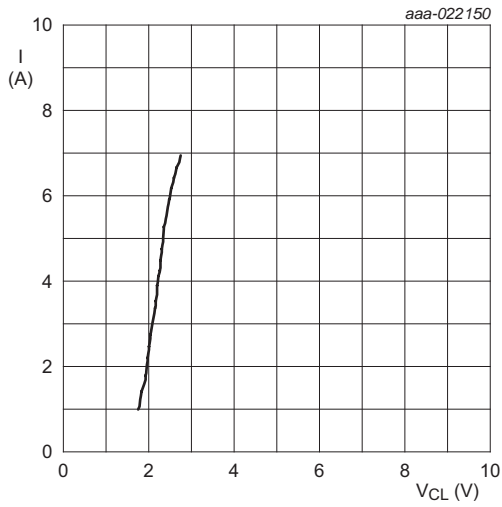

According to IEC 61000-4-5 (8/20 μs)

**Fig 21. Dynamic resistance with positive clamping; typical values**

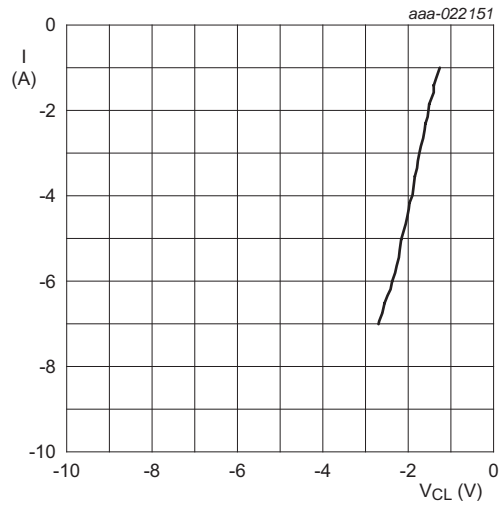

According to IEC 61000-4-5 (8/20 μs)

**Fig 22. Dynamic resistance with negative clamping; typical values**

## 7. Application information

The device is designed to provide high-level ESD protection and common-mode filtering for differential high-speed data line pairs such as:

- USB 3.1
- HDMI 2.0
- Transition-Minimized Differential Signaling (TMDS)
- DisplayPort
- external Serial Advanced Technology Attachment (eSATA)
- Low Voltage Differential Signaling (LVDS)

When designing the PCB, give careful consideration to impedance matching and signal coupling. Do not connect the protected signal lines to unlimited current sources like, for example, a battery.

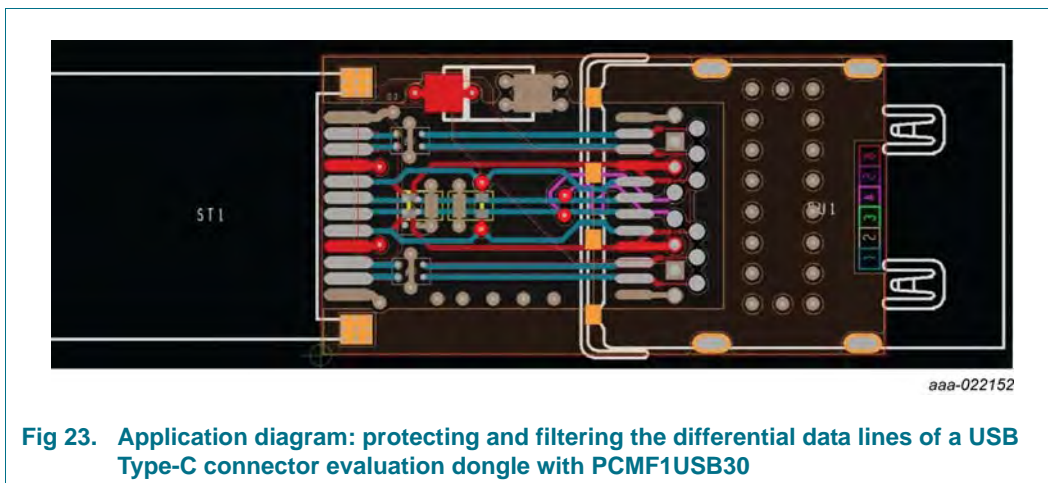

Since the SuperSpeed TX/RX lines are separated by GND or VBUS from the Hi-Speed lines, PCMF1USB30 makes it easy to achieve same signal lengths, straight routing, and optimal positioning for ESD protection directly at the connector.



8. Package outline

WLCSP5: wafer level chip-size package; 5 bumps (2-1-2)

PCMF1USB30

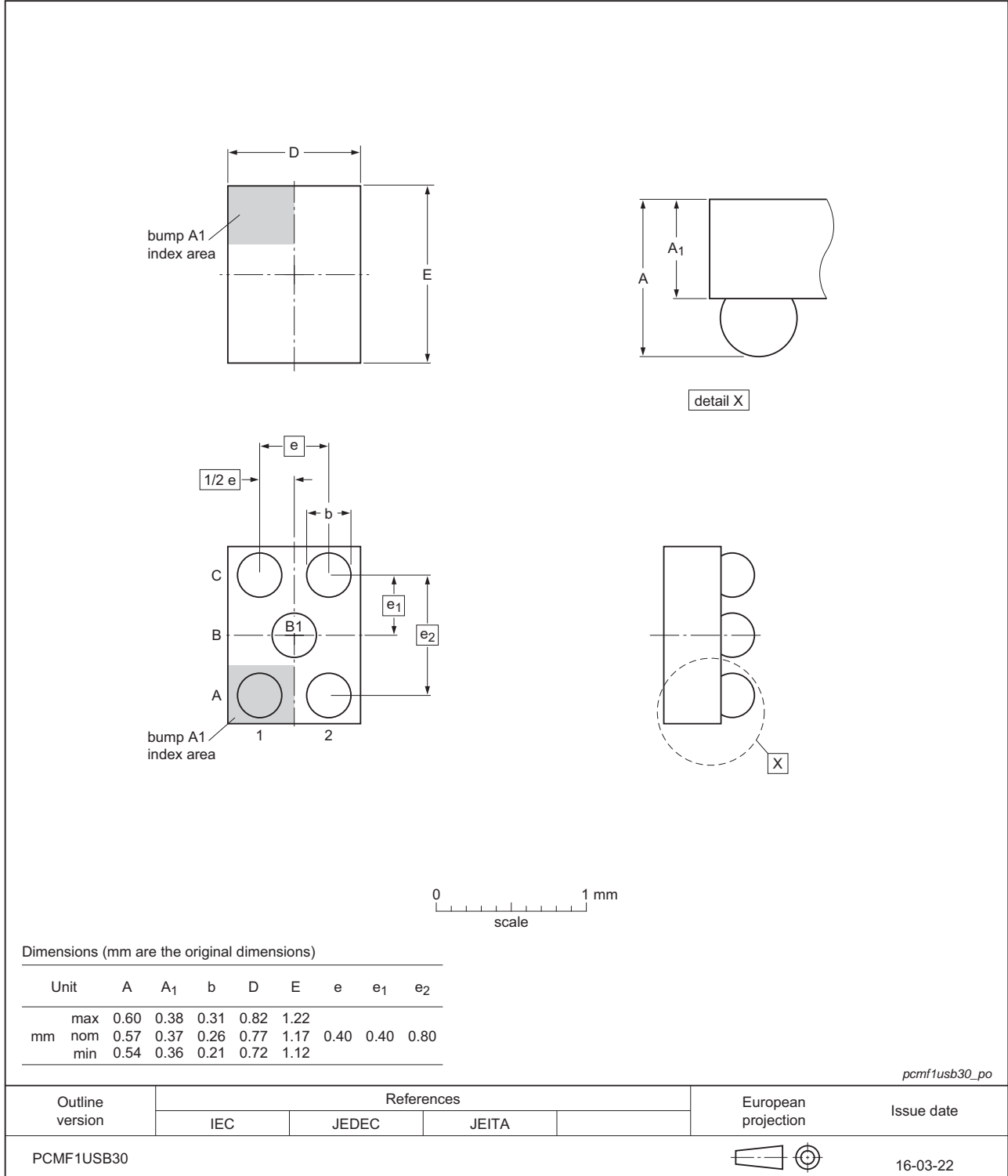

Fig 24. Package outline WLCSP5

WLCSP10: wafer level chip-size package; 10 bumps (4-2-4)

PCMF2USB30

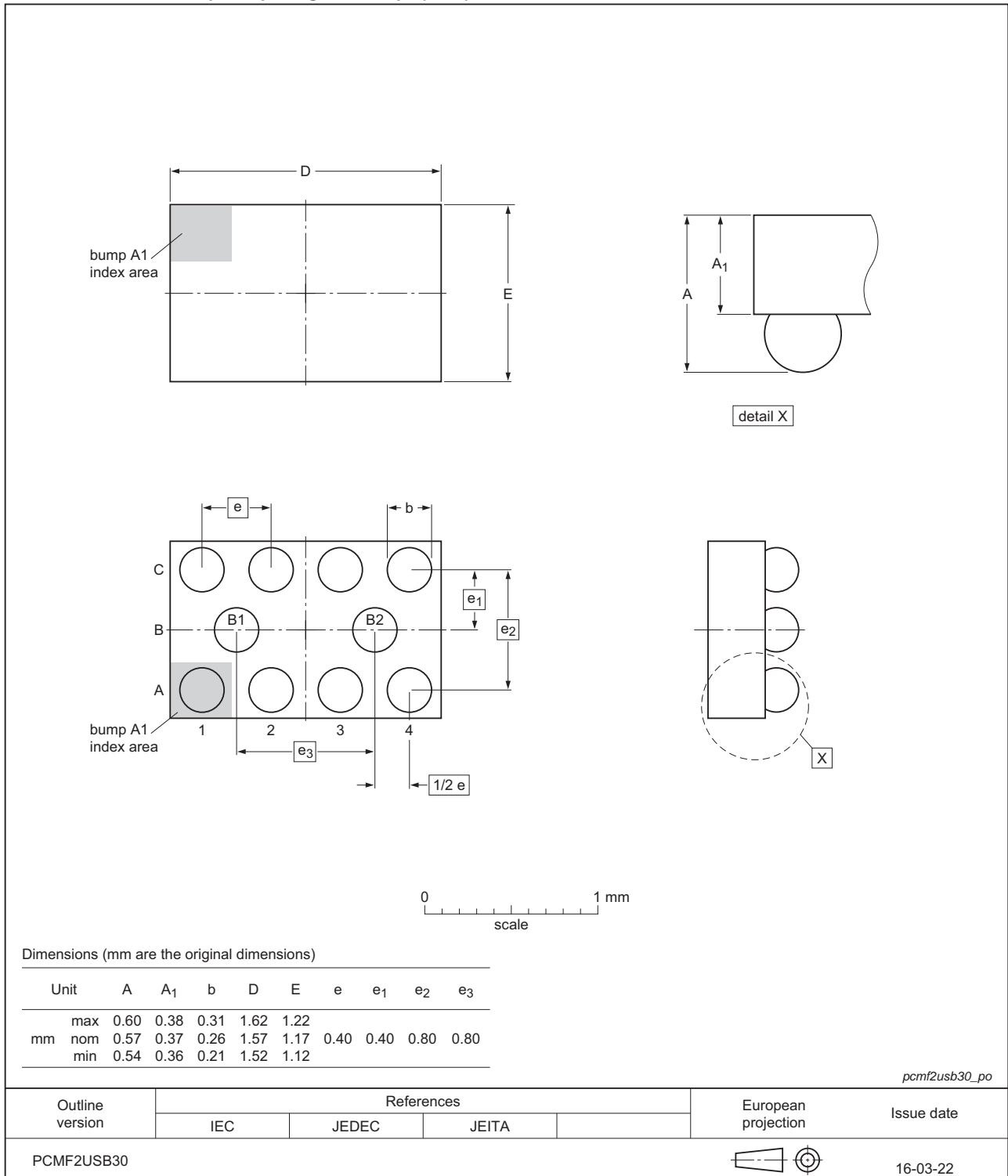

Fig 25. Package outline WLCSP10

WLCSP15: wafer level chip-size package; 15 bumps (6-3-6)

PCMF3USB30

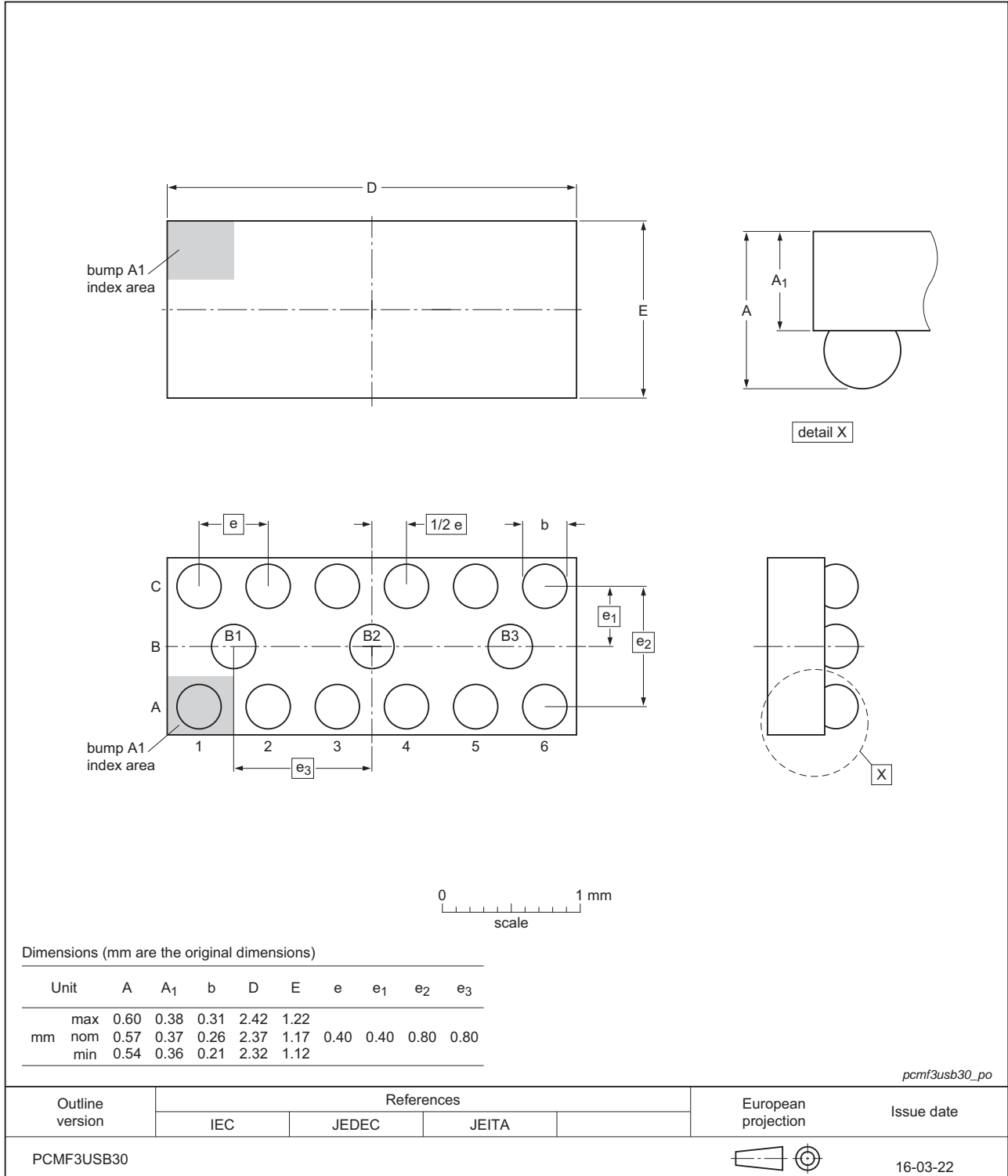

Fig 26. Package outline WLCSP15

9. Soldering

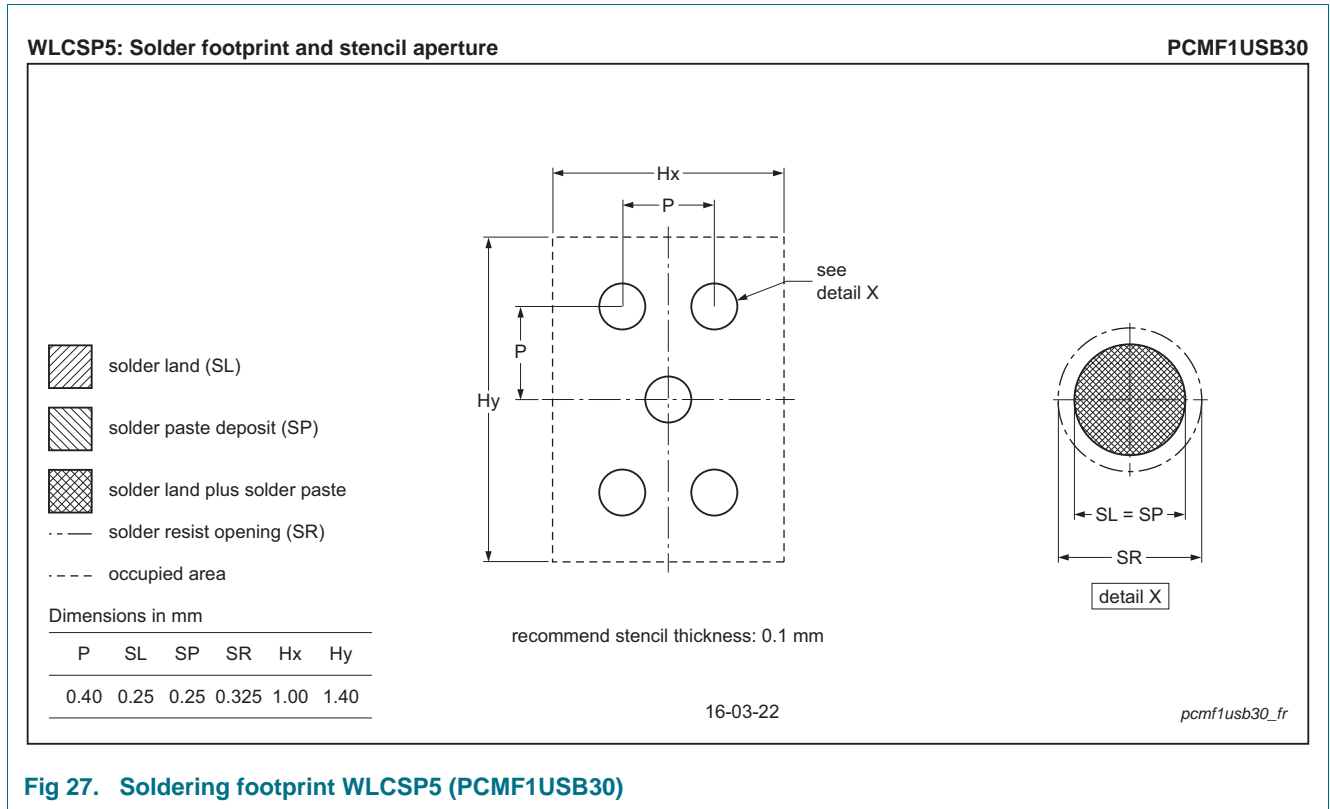

Fig 27. Soldering footprint WLCSP5 (PCMF1USB30)

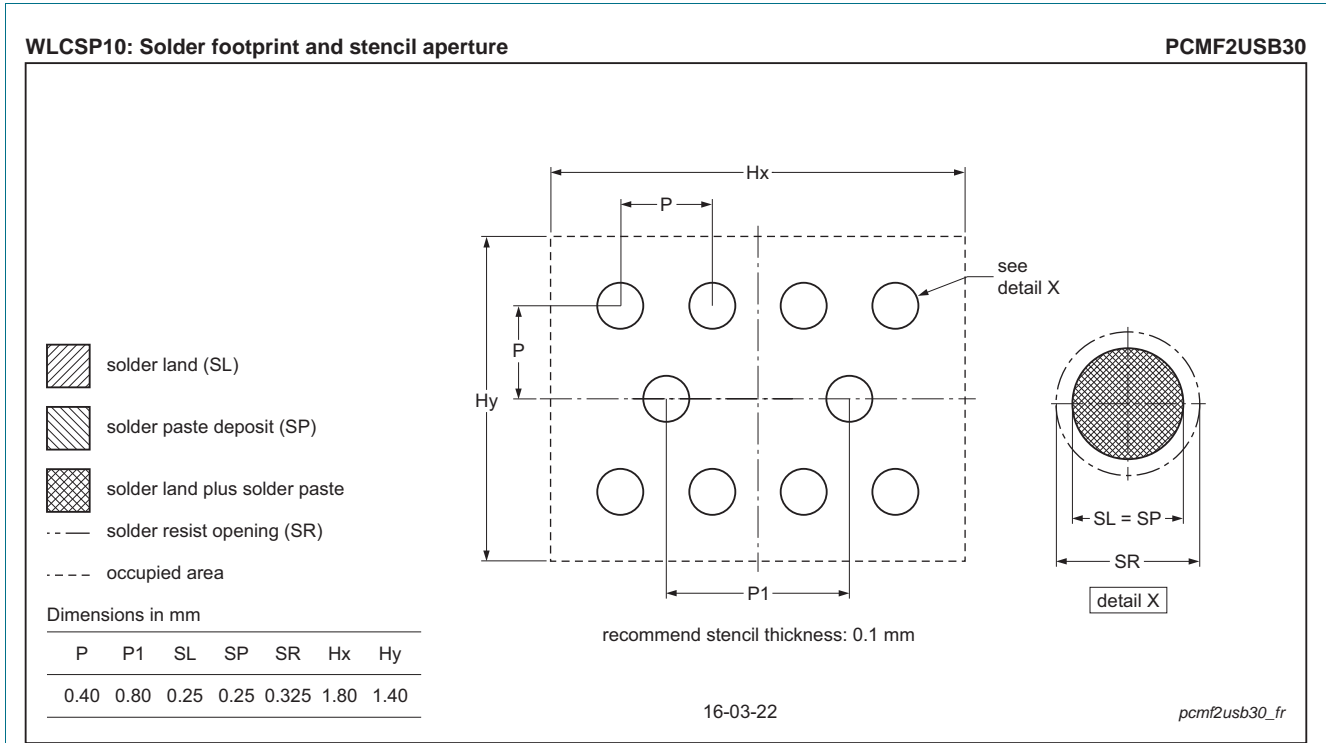

Fig 28. Soldering footprint WLCSP10 (PCMF2USB30)

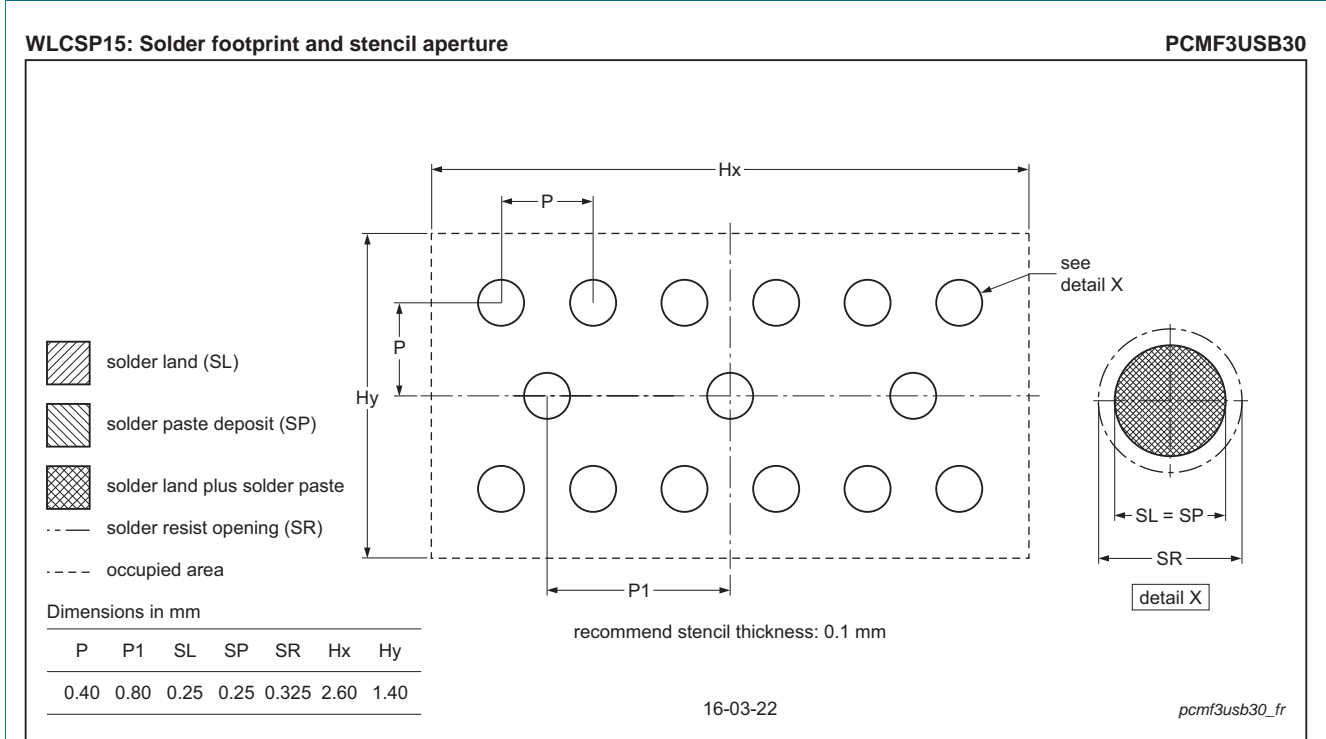

Fig 29. Soldering footprint WLCSP15 (PCMF3USB30)

## 10. Revision history

Table 8. Revision history

Document ID	Release date	Data sheet status	Change notice	Supersedes
PCMFxUSB30_SER v.1	20160401	Product data sheet	-	-



## 11. Legal information

### 11.1 Data sheet status

Document status <sup>[1][2]</sup>	Product status <sup>[3]</sup>	Definition
Objective [short] data sheet	Development	This document contains data from the objective specification for product development.
Preliminary [short] data sheet	Qualification	This document contains data from the preliminary specification.
Product [short] data sheet	Production	This document contains the product specification.

[1] Please consult the most recently issued document before initiating or completing a design.

[2] The term 'short data sheet' is explained in section "Definitions".

[3] The product status of device(s) described in this document may have changed since this document was published and may differ in case of multiple devices. The latest product status information is available on the Internet at URL <http://www.nxp.com>.

### 11.2 Definitions

**Draft** — The document is a draft version only. The content is still under internal review and subject to formal approval, which may result in modifications or additions. NXP Semiconductors does not give any representations or warranties as to the accuracy or completeness of information included herein and shall have no liability for the consequences of use of such information.

**Short data sheet** — A short data sheet is an extract from a full data sheet with the same product type number(s) and title. A short data sheet is intended for quick reference only and should not be relied upon to contain detailed and full information. For detailed and full information see the relevant full data sheet, which is available on request via the local NXP Semiconductors sales office. In case of any inconsistency or conflict with the short data sheet, the full data sheet shall prevail.

**Product specification** — The information and data provided in a Product data sheet shall define the specification of the product as agreed between NXP Semiconductors and its customer, unless NXP Semiconductors and customer have explicitly agreed otherwise in writing. In no event however, shall an agreement be valid in which the NXP Semiconductors product is deemed to offer functions and qualities beyond those described in the Product data sheet.

### 11.3 Disclaimers

**Limited warranty and liability** — Information in this document is believed to be accurate and reliable. However, NXP Semiconductors does not give any representations or warranties, expressed or implied, as to the accuracy or completeness of such information and shall have no liability for the consequences of use of such information. NXP Semiconductors takes no responsibility for the content in this document if provided by an information source outside of NXP Semiconductors.

In no event shall NXP Semiconductors be liable for any indirect, incidental, punitive, special or consequential damages (including - without limitation - lost profits, lost savings, business interruption, costs related to the removal or replacement of any products or rework charges) whether or not such damages are based on tort (including negligence), warranty, breach of contract or any other legal theory.

Notwithstanding any damages that customer might incur for any reason whatsoever, NXP Semiconductors' aggregate and cumulative liability towards customer for the products described herein shall be limited in accordance with the *Terms and conditions of commercial sale* of NXP Semiconductors.

**Right to make changes** — NXP Semiconductors reserves the right to make changes to information published in this document, including without limitation specifications and product descriptions, at any time and without notice. This document supersedes and replaces all information supplied prior to the publication hereof.

**Suitability for use** — NXP Semiconductors products are not designed, authorized or warranted to be suitable for use in life support, life-critical or safety-critical systems or equipment, nor in applications where failure or malfunction of an NXP Semiconductors product can reasonably be expected to result in personal injury, death or severe property or environmental damage. NXP Semiconductors and its suppliers accept no liability for inclusion and/or use of NXP Semiconductors products in such equipment or applications and therefore such inclusion and/or use is at the customer's own risk.

**Applications** — Applications that are described herein for any of these products are for illustrative purposes only. NXP Semiconductors makes no representation or warranty that such applications will be suitable for the specified use without further testing or modification.

Customers are responsible for the design and operation of their applications and products using NXP Semiconductors products, and NXP Semiconductors accepts no liability for any assistance with applications or customer product design. It is customer's sole responsibility to determine whether the NXP Semiconductors product is suitable and fit for the customer's applications and products planned, as well as for the planned application and use of customer's third party customer(s). Customers should provide appropriate design and operating safeguards to minimize the risks associated with their applications and products.

NXP Semiconductors does not accept any liability related to any default, damage, costs or problem which is based on any weakness or default in the customer's applications or products, or the application or use by customer's third party customer(s). Customer is responsible for doing all necessary testing for the customer's applications and products using NXP Semiconductors products in order to avoid a default of the applications and the products or of the application or use by customer's third party customer(s). NXP does not accept any liability in this respect.

**Limiting values** — Stress above one or more limiting values (as defined in the Absolute Maximum Ratings System of IEC 60134) will cause permanent damage to the device. Limiting values are stress ratings only and (proper) operation of the device at these or any other conditions above those given in the Recommended operating conditions section (if present) or the Characteristics sections of this document is not warranted. Constant or repeated exposure to limiting values will permanently and irreversibly affect the quality and reliability of the device.

**Terms and conditions of commercial sale** — NXP Semiconductors products are sold subject to the general terms and conditions of commercial sale, as published at <http://www.nxp.com/profile/terms>, unless otherwise agreed in a valid written individual agreement. In case an individual agreement is concluded only the terms and conditions of the respective agreement shall apply. NXP Semiconductors hereby expressly objects to applying the customer's general terms and conditions with regard to the purchase of NXP Semiconductors products by customer.

**No offer to sell or license** — Nothing in this document may be interpreted or construed as an offer to sell products that is open for acceptance or the grant, conveyance or implication of any license under any copyrights, patents or other industrial or intellectual property rights.

**Export control** — This document as well as the item(s) described herein may be subject to export control regulations. Export might require a prior authorization from competent authorities.

**Quick reference data** — The Quick reference data is an extract of the product data given in the Limiting values and Characteristics sections of this document, and as such is not complete, exhaustive or legally binding.

**Non-automotive qualified products** — Unless this data sheet expressly states that this specific NXP Semiconductors product is automotive qualified, the product is not suitable for automotive use. It is neither qualified nor tested in accordance with automotive testing or application requirements. NXP Semiconductors accepts no liability for inclusion and/or use of non-automotive qualified products in automotive equipment or applications.

In the event that customer uses the product for design-in and use in automotive applications to automotive specifications and standards, customer (a) shall use the product without NXP Semiconductors' warranty of the

product for such automotive applications, use and specifications, and (b) whenever customer uses the product for automotive applications beyond NXP Semiconductors' specifications such use shall be solely at customer's own risk, and (c) customer fully indemnifies NXP Semiconductors for any liability, damages or failed product claims resulting from customer design and use of the product for automotive applications beyond NXP Semiconductors' standard warranty and NXP Semiconductors' product specifications.

**Translations** — A non-English (translated) version of a document is for reference only. The English version shall prevail in case of any discrepancy between the translated and English versions.

## 11.4 Trademarks

Notice: All referenced brands, product names, service names and trademarks are the property of their respective owners.

## 12. Contact information

For more information, please visit: <http://www.nxp.com>

For sales office addresses, please send an email to: [salesaddresses@nxp.com](mailto:salesaddresses@nxp.com)

## 13. Contents

<b>1</b>	<b>Product profile</b> . . . . .	<b>1</b>
1.1	General description . . . . .	1
1.2	Features and benefits . . . . .	1
1.3	Applications . . . . .	1
<b>2</b>	<b>Pinning information</b> . . . . .	<b>2</b>
<b>3</b>	<b>Ordering information</b> . . . . .	<b>3</b>
<b>4</b>	<b>Marking</b> . . . . .	<b>3</b>
<b>5</b>	<b>Limiting values</b> . . . . .	<b>3</b>
<b>6</b>	<b>Characteristics</b> . . . . .	<b>4</b>
6.1	Channel characteristics . . . . .	4
6.2	Frequency characteristics . . . . .	4
<b>7</b>	<b>Application information</b> . . . . .	<b>14</b>
<b>8</b>	<b>Package outline</b> . . . . .	<b>15</b>
<b>9</b>	<b>Soldering</b> . . . . .	<b>18</b>
<b>10</b>	<b>Revision history</b> . . . . .	<b>20</b>
<b>11</b>	<b>Legal information</b> . . . . .	<b>21</b>
11.1	Data sheet status . . . . .	21
11.2	Definitions . . . . .	21
11.3	Disclaimers . . . . .	21
11.4	Trademarks . . . . .	22
<b>12</b>	<b>Contact information</b> . . . . .	<b>22</b>
<b>13</b>	<b>Contents</b> . . . . .	<b>23</b>

Please be aware that important notices concerning this document and the product(s) described herein, have been included in section 'Legal information'.

© NXP Semiconductors N.V. 2016.

All rights reserved.

For more information, please visit: <http://www.nxp.com>

For sales office addresses, please send an email to: [salesaddresses@nxp.com](mailto:salesaddresses@nxp.com)

Date of release: 01 April 2016

Document identifier: PCMFxUSB30\_SER