

SCC1300-D04

In Production REACH

Appearance & Shape

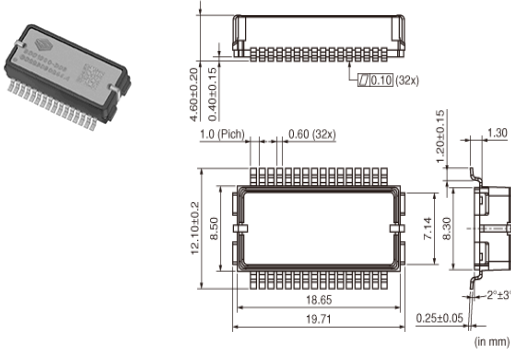

Packaging Information

Packaging	Specifications	Minimum Order Quantity
-05	330mm Embossed Tape	50

Attention

1. This datasheet is downloaded from the website of Murata Manufacturing Co., Ltd. Therefore, its specifications are subject to change or our products may be discontinued without advance notice. Please check with our sales representatives or product engineers before ordering.
 2. This datasheet has only typical specifications because there is no space for detailed specifications.
 Therefore, please review our product specifications or consult the approval sheet for product specifications before ordering.

SCC1300-D04

Specifications

Output Type	SPI
Supply Voltage	3.3&5.0V
Axis	3 / 1(X)
Mass	1.17g
Maximum Angular Velocity	+/-6g,300deg/s
Sensitivity	650 count/g 18 count/dps
Offset Temp. Characteristic	+/-40mg +/-0.9dps
Amplitude Response	30...55Hz 50Hz

Attention

1.This datasheet is downloaded from the website of Murata Manufacturing Co., Ltd. Therefore, it's specifications are subject to change or our products may be discontinued without advance notice. Please check with our sales representatives or product engineers before ordering.
2.This datasheet has only typical specifications because there is no space for detailed specifications.
Therefore, please review our product specifications or consult the approval sheet for product specifications before ordering.