

GRM155C70J225ME11#

"#" indicates a package specification code.



< List of part numbers with package codes >
GRM155C70J225ME11D , GRM155C70J225ME11J

Shape

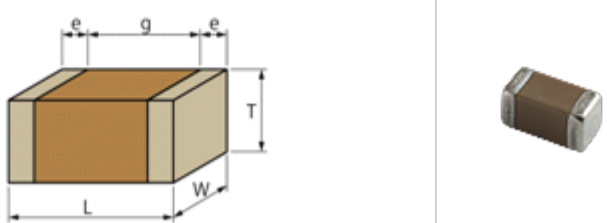

L size	1.0 ± 0.2mm
W size	0.5 ± 0.2mm
T size	0.5 ± 0.2mm
External terminal width e	0.15 to 0.35mm
Distance between external terminals g	0.3mm min.
Size code in inch(mm)	0402 (1005)

References

Packaging	Specifications	Minimum quantity
D	180mm Paper taping	10000
J	330mm Paper taping	40000

Mass (typ.)	
1 piece	3.1mg
180mm Reel	149g

Specifications

Capacitance	2.2μF ± 20%
Rated voltage	6.3Vdc
Temperature characteristics (complied standard)	X7S(EIA)
Capacitance change rate	± 22.0%
Temperature range of temperature characteristics	-55 to 125
Operating temperature range	-55 to 125

⚠ Attention

- 1.This datasheet is downloaded from the website of Murata Manufacturing Co., Ltd. Therefore, it ' s specifications are subject to change or our products in it may be discontinued without advance notice. Please check with our sales representatives or product engineers before ordering.
- 2.This datasheet has only typical specifications because there is no space for detailed specifications. Therefore, please review our product specifications or consult the approval sheet for product specifications before ordering.

▪ Frequency characteristics (ESR, Impedance)

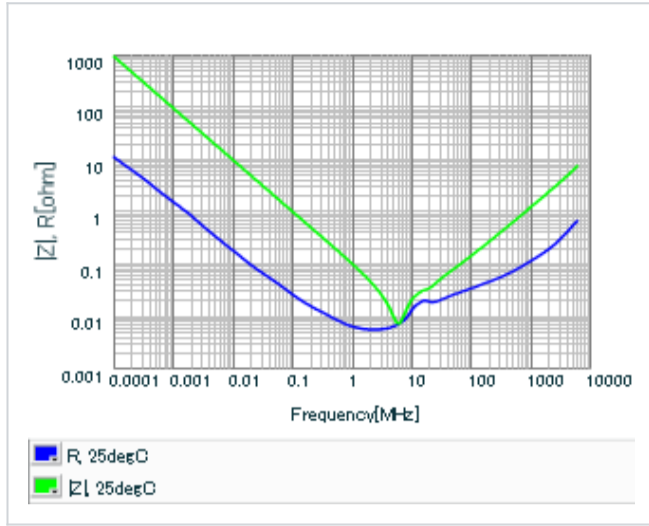

▪ S parameter (Smith chart S11)

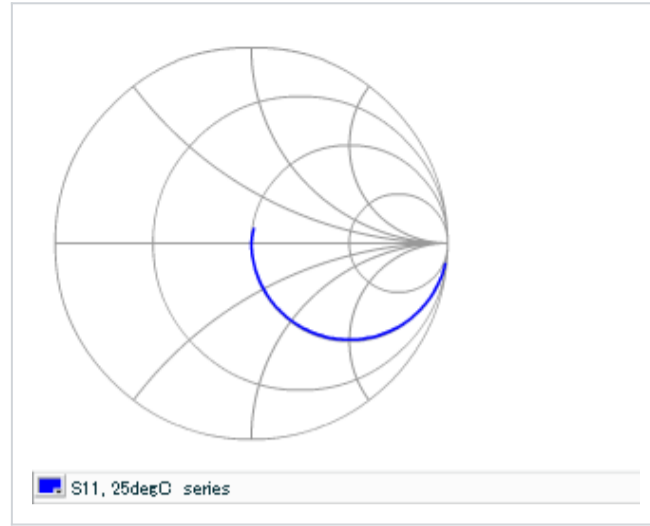

▪ DC bias characteristics

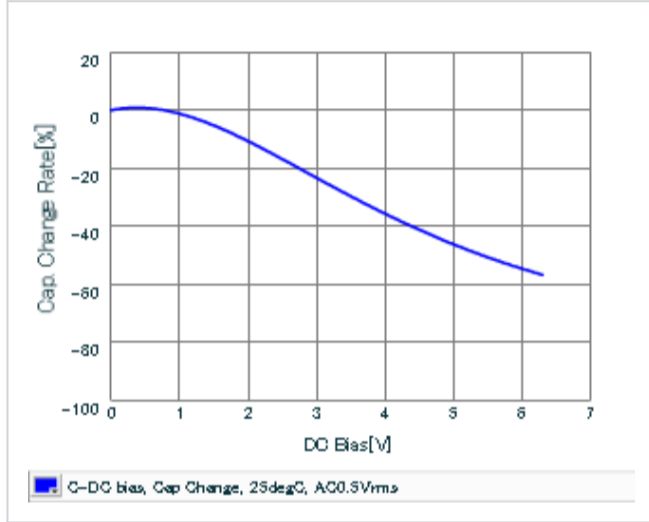

▪ AC voltage characteristics

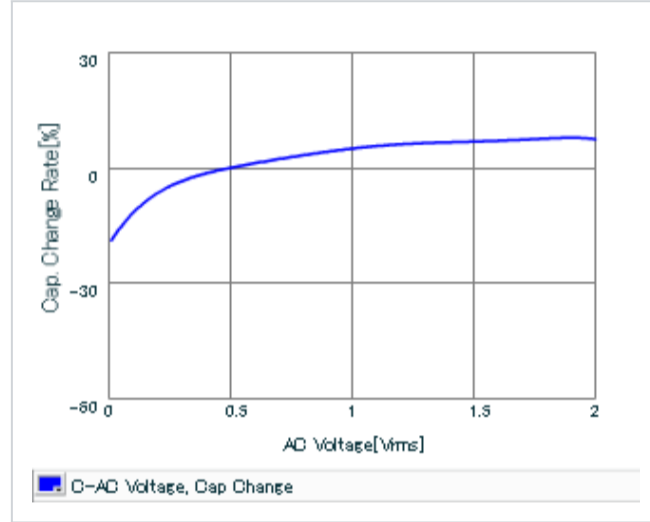

▪ Capacitance - temperature characteristics

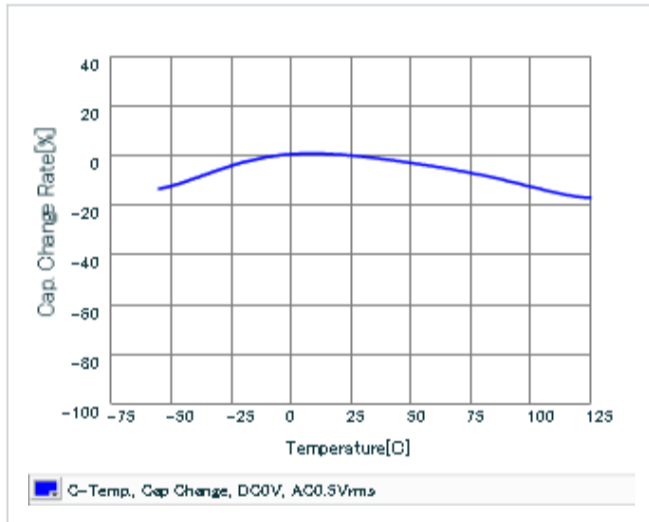

▪ Calorific property by ripple current

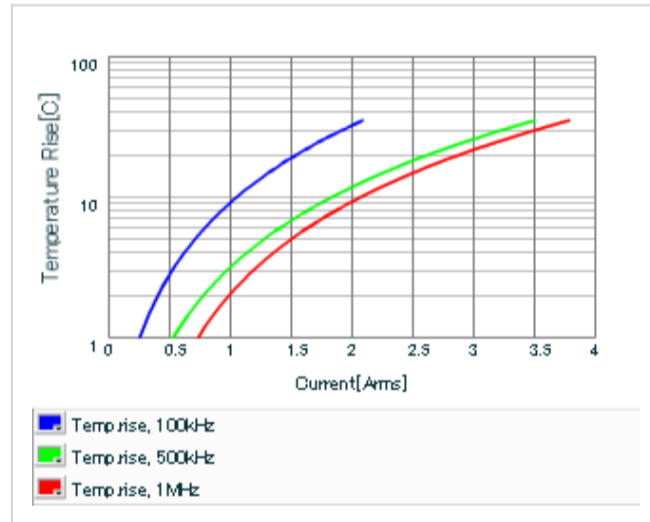

This PDF data has only typical specifications because there is no space for detailed specifications. Therefore, please review our product specifications or consult the approval sheet for product specifications before ordering.