

# DEHR33D472KA4B

" # " indicates a package specification code.



< List of part numbers with package codes >  
DEHR33D472KA4B

## Shape

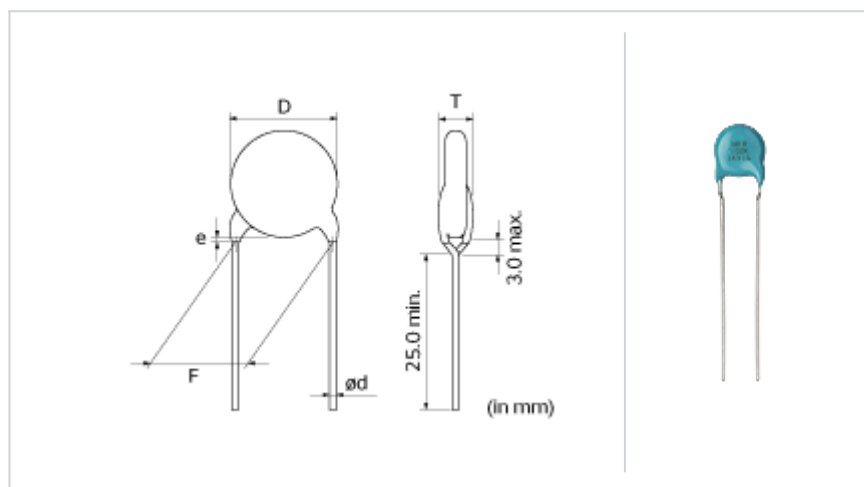

L size or outer diameter D (mm)	21.0 mm max.
T size	5.0 mm max.
Lead spacing F	10.0 ± 1.0mm
Lead diameter d	0.6 ± 0.05mm
Paint dripping e	Up to the end of crimp

## References

Packaging	Specifications	Minimum quantity
B	Packing in bulk	50

## Specifications

Capacitance	4700pF ± 10%
Rated voltage	2000Vdc
Temperature characteristics (complied standard)	R(JIS)
Capacitance change rate (1)	± 15%(-25 to 85 )
Capacitance change rate (2)	+15/-30%(85 to 125 )
Temperature range of temperature characteristics	-25 to 125
Operating temperature range	-25 to 125

### ⚠ Attention

- 1.This datasheet is downloaded from the website of Murata Manufacturing Co., Ltd. Therefore, it ' s specifications are subject to change or our products in it may be discontinued without advance notice. Please check with our sales representatives or product engineers before ordering.
- 2.This datasheet has only typical specifications because there is no space for detailed specifications. Therefore, please review our product specifications or consult the approval sheet for product specifications before ordering.