

P-Channel 100 V (D-S) MOSFET

PRODUCT SUMMARY			
V_{DS} (V)	$R_{DS(on)}$ (Ω)	I_D (A)	Q_g (Typ.)
- 100	0.195 at $V_{GS} = - 10$ V	- 8.8	11.7
	0.210 at $V_{GS} = - 4.5$ V	- 8.5	

FEATURES

- Halogen-free According to IEC 61249-2-21 Definition
- TrenchFET® Power MOSFET
- 100 % R_g and UIS Tested
- Compliant to RoHS Directive 2002/95/EC



RoHS
COMPLIANT
HALOGEN
FREE

APPLICATIONS

- Power Switch
- DC/DC Converters

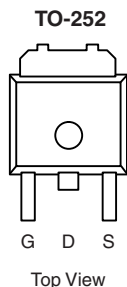

Drain Connected to Tab

Ordering Information: SUD09P10-195-GE3 (Lead (Pb)-free and Halogen-free)

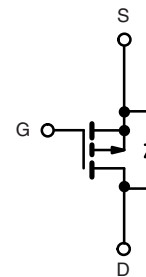

P-Channel MOSFET

ABSOLUTE MAXIMUM RATINGS $T_C = 25$ °C, unless otherwise noted				
Parameter	Symbol	Limit	Unit	
Drain-Source Voltage	V_{DS}	- 100	V	
Gate-Source Voltage	V_{GS}	± 20		
Continuous Drain Current ($T_J = 150$ °C)	I_D	$T_C = 25$ °C	- 8.8	A
		$T_C = 70$ °C	- 7.1	
Pulsed Drain Current	I_{DM}	- 15		
Avalanche Current	I_{AS}	- 18		
Single Avalanche Energy ^a	E_{AS}	16.2	mJ	
Maximum Power Dissipation ^a	P_D	$T_C = 25$ °C	32.1 ^b	W
		$T_A = 25$ °C ^c	2.5	
Operating Junction and Storage Temperature Range	T_J, T_{stg}	- 55 to 150	°C	

THERMAL RESISTANCE RATINGS				
Parameter	Symbol	Limit	Unit	
Junction-to-Ambient (PCB Mount) ^c	R_{thJA}	50	°C/W	
Junction-to-Case (Drain)	R_{thJC}	3.9		

Notes:

a. Duty cycle ≤ 1 %.

b. See SOA curve for voltage derating.

c. When Mounted on 1" square PCB (FR-4 material).

SPECIFICATIONS $T_J = 25\text{ }^\circ\text{C}$, unless otherwise noted						
Parameter	Symbol	Test Conditions	Min.	Typ.	Max.	Unit
Static						
Drain-Source Breakdown Voltage	V_{DS}	$V_{DS} = 0\text{ V}, I_D = -250\text{ }\mu\text{A}$	-100			V
Gate Threshold Voltage	$V_{GS(th)}$	$V_{DS} = V_{GS}, I_D = -250\text{ }\mu\text{A}$	-1		-2.5	
Gate-Body Leakage	I_{GSS}	$V_{DS} = 0\text{ V}, V_{GS} = \pm 20\text{ V}$			± 250	nA
Zero Gate Voltage Drain Current	I_{DSS}	$V_{DS} = -100\text{ V}, V_{GS} = 0\text{ V}$			-1	μA
		$V_{DS} = -100\text{ V}, V_{GS} = 0\text{ V}, T_J = 125\text{ }^\circ\text{C}$			-50	
		$V_{DS} = -100\text{ V}, V_{GS} = 0\text{ V}, T_J = 150\text{ }^\circ\text{C}$			-250	
On-State Drain Current ^a	$I_{D(on)}$	$V_{DS} \leq -10\text{ V}, V_{GS} = -10\text{ V}$	-15			A
Drain-Source On-State Resistance ^a	$R_{DS(on)}$	$V_{GS} = -10\text{ V}, I_D = -3.6\text{ A}$		0.162	0.195	Ω
		$V_{GS} = -4.5\text{ V}, I_D = -3.4\text{ A}$		0.175	0.210	
Forward Transconductance ^a	g_{fs}	$V_{DS} = -15\text{ V}, I_D = -3.6\text{ A}$		12		S
Dynamic^b						
Input Capacitance	C_{iss}	$V_{GS} = 0\text{ V}, V_{DS} = -50\text{ V}, f = 1\text{ MHz}$		1055		μF
Output Capacitance	C_{oss}			65		
Reverse Transfer Capacitance	C_{rss}			41		
Total Gate Charge ^c	Q_g	$V_{DS} = -50\text{ V}, V_{GS} = -10\text{ V}, I_D = -3.6\text{ A}$		23.2	34.8	nC
		$V_{DS} = -50\text{ V}, V_{GS} = -4.5\text{ V}, I_D = -3.6\text{ A}$		11.7	17.6	
Gate-Source Charge ^c	Q_{gs}			3.5		
Gate-Drain Charge ^c	Q_{gd}			4.8		
Gate Resistance	R_g	$f = 1\text{ MHz}$	1.2	5.7	11.5	Ω
Turn-On Delay Time ^c	$t_{d(on)}$	$V_{DD} = -50\text{ V}, R_L = 17.2\text{ }\Omega$ $I_D \cong -2.9\text{ A}, V_{GEN} = -10\text{ V}, R_g = 1\text{ }\Omega$		7	14	ns
Rise Time ^c	t_r			12	18	
Turn-Off Delay Time ^c	$t_{d(off)}$			33	50	
Fall Time ^c	t_f			9	18	
Drain-Source Body Diode Ratings and Characteristics $T_C = 25\text{ }^\circ\text{C}$ ^b						
Continuous Current	I_S				-8.8	A
Pulsed Current	I_{SM}				-15	
Forward Voltage ^a	V_{SD}	$I_F = -2.9\text{ A}, V_{GS} = 0\text{ V}$		-0.8	-1.5	V
Reverse Recovery Time	t_{rr}	$I_F = -2.9\text{ A}, di/dt = 100\text{ A}/\mu\text{s}$		50	75	ns
Peak Reverse Recovery Current	$I_{RM(REC)}$			-4	-6	A
Reverse Recovery Charge	Q_{rr}				98	147

Notes:

- a. Pulse test; pulse width $\leq 300\text{ }\mu\text{s}$, duty cycle $\leq 2\%$.
b. Guaranteed by design, not subject to production testing.
c. Independent of operating temperature.

Stresses beyond those listed under "Absolute Maximum Ratings" may cause permanent damage to the device. These are stress ratings only, and functional operation of the device at these or any other conditions beyond those indicated in the operational sections of the specifications is not implied. Exposure to absolute maximum rating conditions for extended periods may affect device reliability.

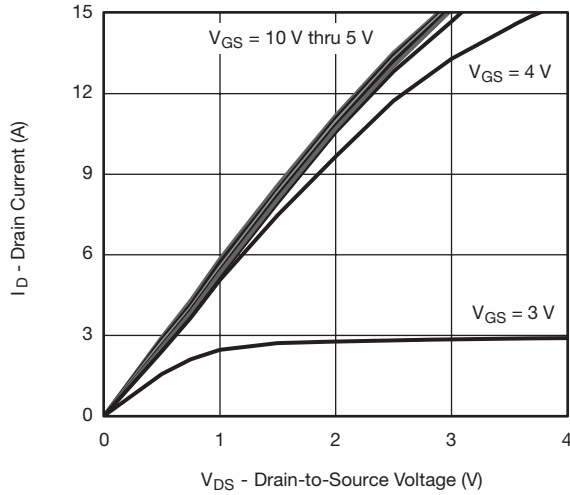
TYPICAL CHARACTERISTICS 25 °C, unless otherwise noted

$V_{GS} = 10$ V thru 5 V
 $V_{GS} = 4$ V
 $V_{GS} = 3$ V

Output Characteristics

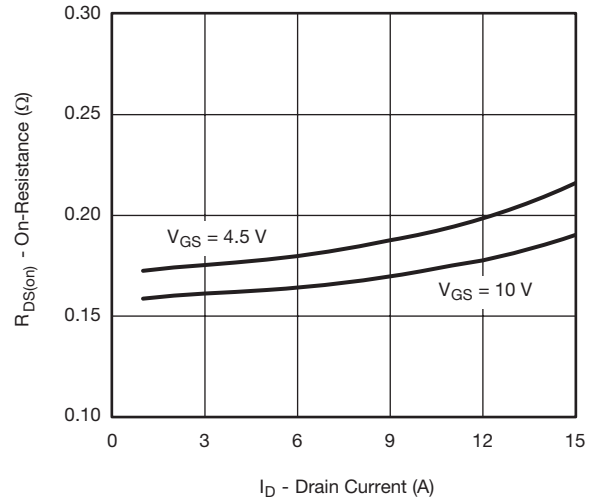

$V_{GS} = 4.5$ V
 $V_{GS} = 10$ V

On-Resistance vs. Drain Current

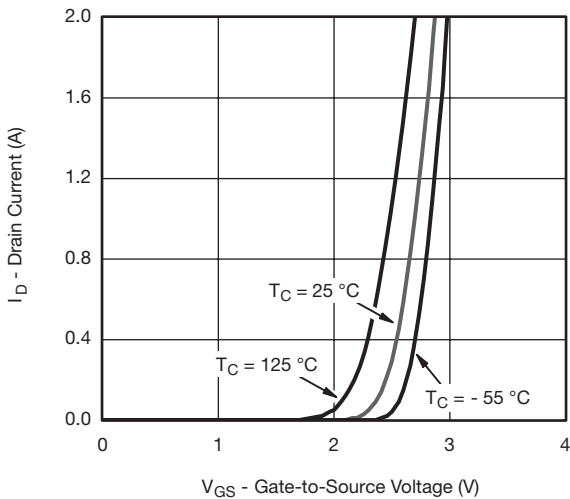

$T_C = 25$ °C
 $T_C = 125$ °C
 $T_C = -55$ °C

Transfer Characteristics

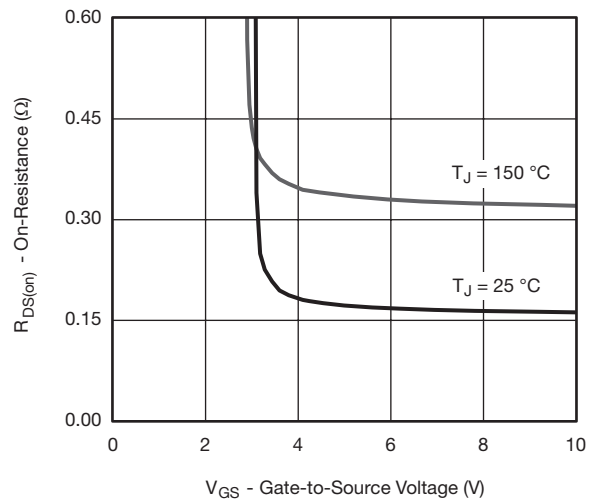

$T_J = 150$ °C
 $T_J = 25$ °C

On-Resistance vs. Gate-to-Source Voltage

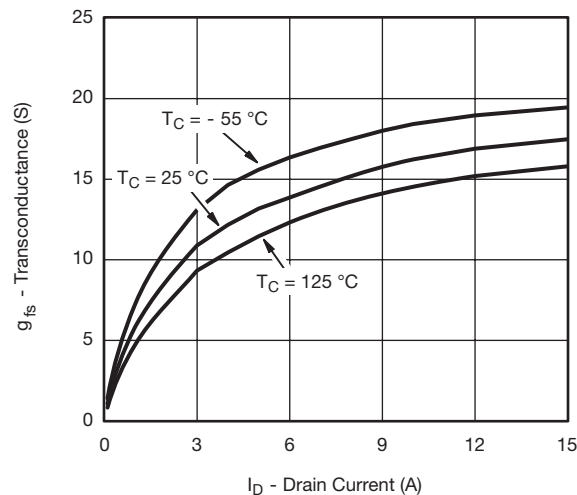

$T_C = -55$ °C
 $T_C = 25$ °C
 $T_C = 125$ °C

Transconductance

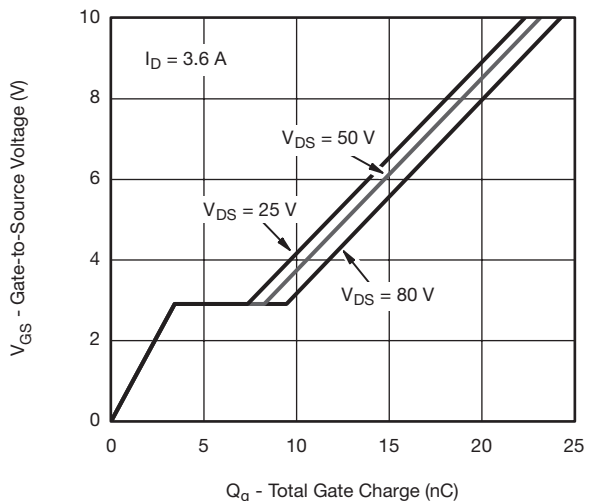

$I_D = 3.6$ A
 $V_{DS} = 50$ V
 $V_{DS} = 25$ V
 $V_{DS} = 80$ V

Gate Charge

TYPICAL CHARACTERISTICS 25 °C, unless otherwise noted

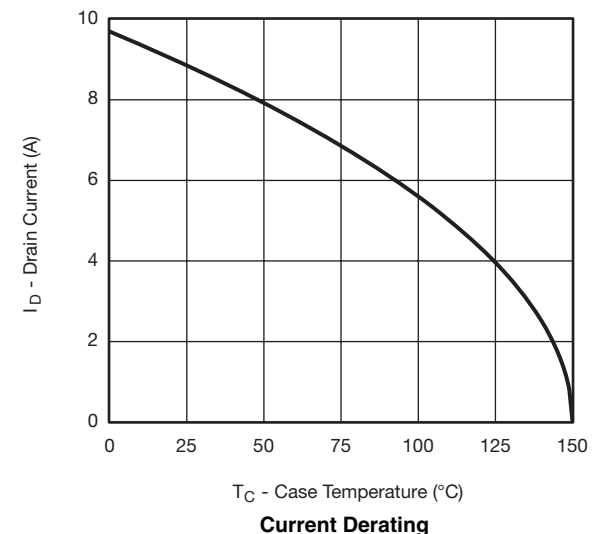
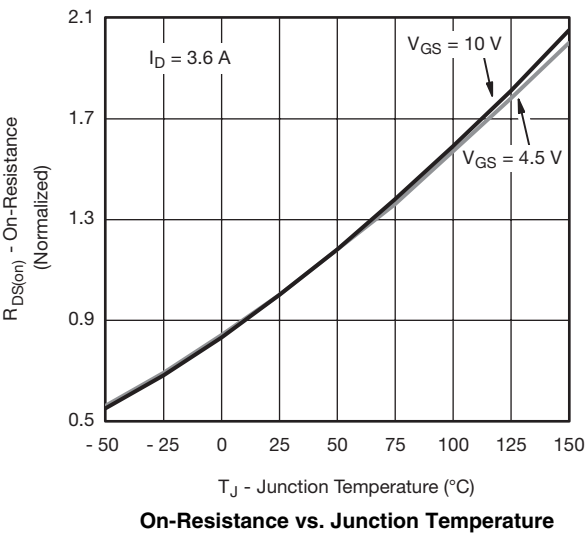
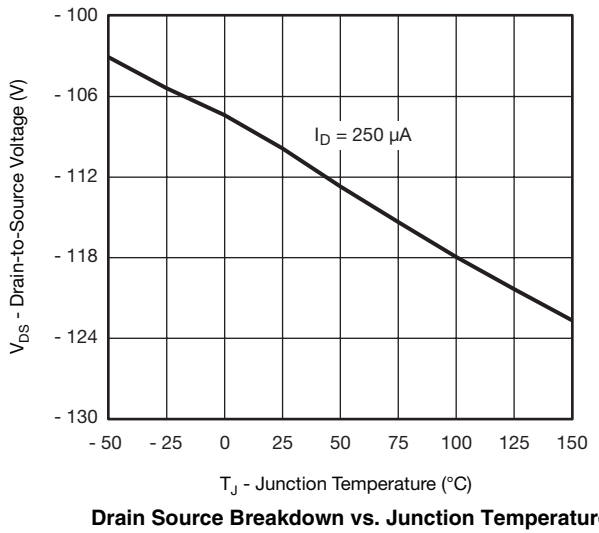
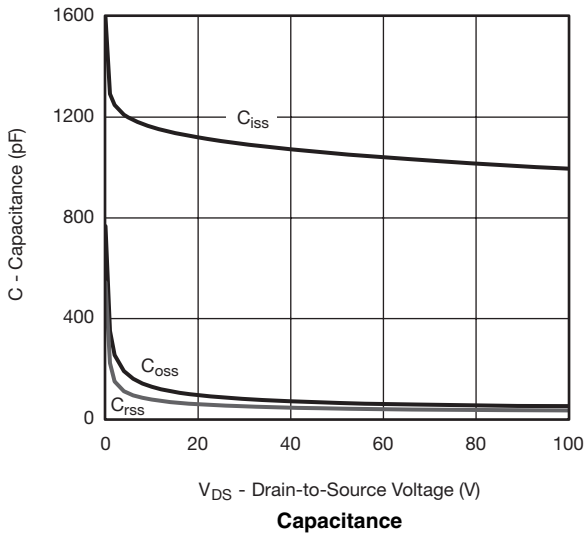
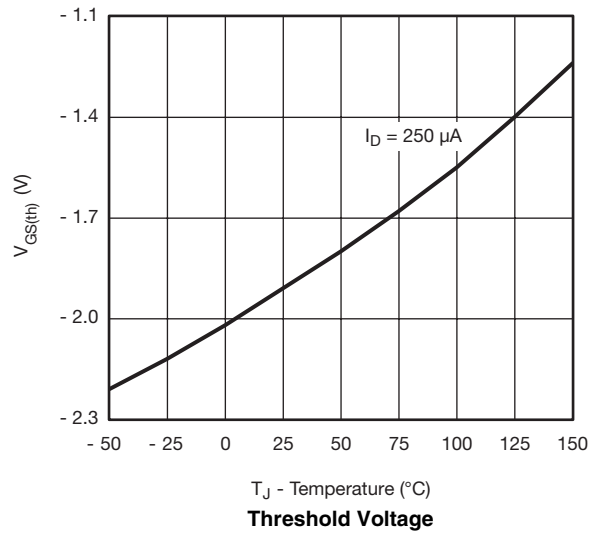
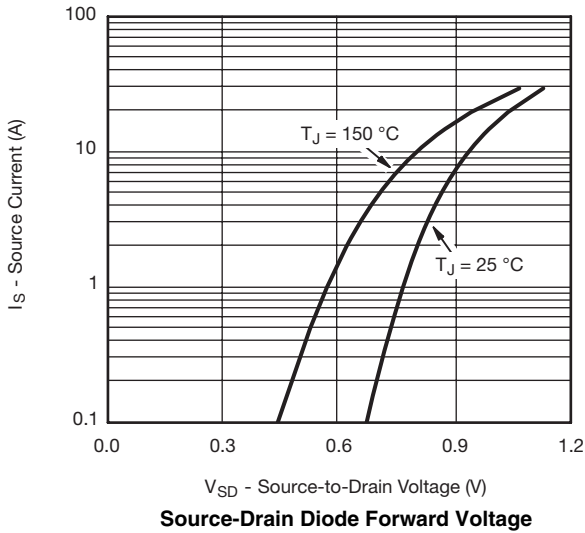

TYPICAL CHARACTERISTICS 25 °C, unless otherwise noted

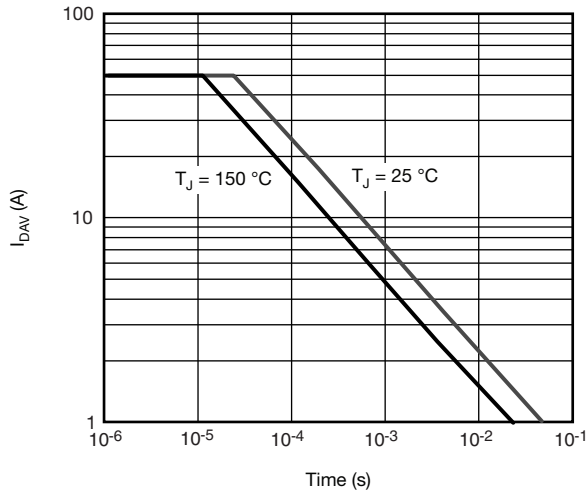

Single Pulse Avalanche Current Capability vs. Time

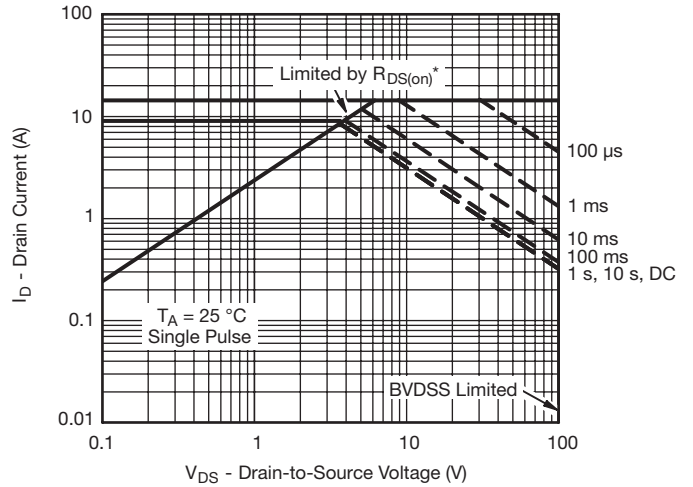

* $V_{GS} >$ minimum V_{GS} at which $R_{DS(on)}$ is specified

Safe Operating Area

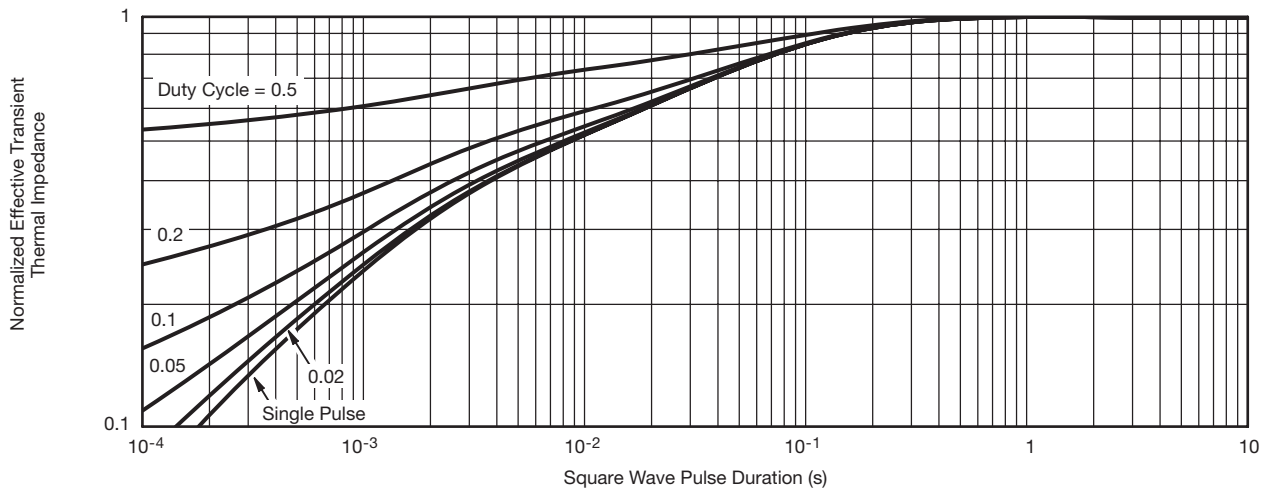

Normalized Thermal Transient Impedance, Junction-to-Case

Vishay Siliconix maintains worldwide manufacturing capability. Products may be manufactured at one of several qualified locations. Reliability data for Silicon Technology and Package Reliability represent a composite of all qualified locations. For related documents such as package/tape drawings, part marking, and reliability data, see www.vishay.com/ppg?65903.



TO-252AA Case Outline

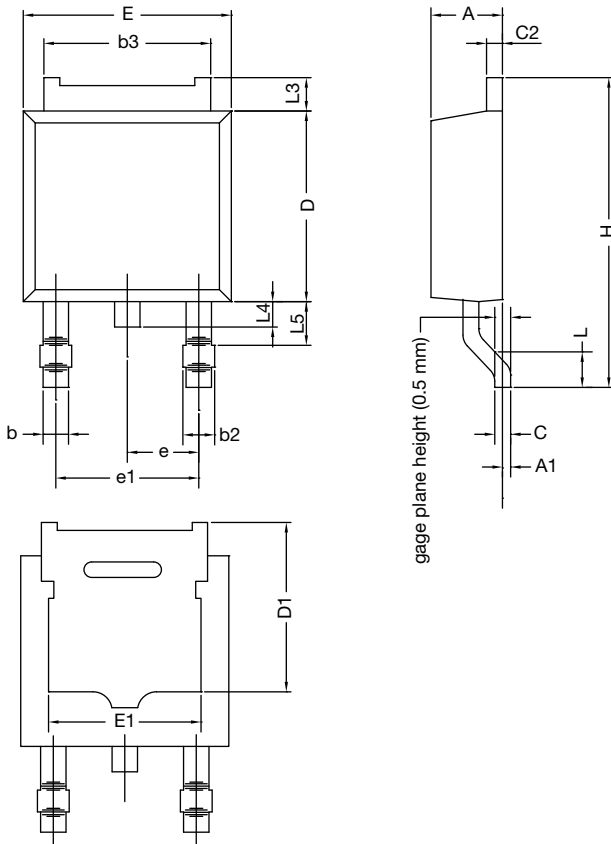

DIM.	MILLIMETERS		INCHES	
	MIN.	MAX.	MIN.	MAX.
A	2.18	2.38	0.086	0.094
A1	-	0.127	-	0.005
b	0.64	0.88	0.025	0.035
b2	0.76	1.14	0.030	0.045
b3	4.95	5.46	0.195	0.215
C	0.46	0.61	0.018	0.024
C2	0.46	0.89	0.018	0.035
D	5.97	6.22	0.235	0.245
D1	4.10	-	0.161	-
E	6.35	6.73	0.250	0.265
E1	4.32	-	0.170	-
H	9.40	10.41	0.370	0.410
e	2.28 BSC		0.090 BSC	
e1	4.56 BSC		0.180 BSC	
L	1.40	1.78	0.055	0.070
L3	0.89	1.27	0.035	0.050
L4	-	1.02	-	0.040
L5	1.01	1.52	0.040	0.060

ECN: T13-0359-Rev. O, 03-Jun-13
DWG: 5347

Notes

- Dimension L3 is for reference only.
- Xi'an, Mingxin, and GEM SH actual photo.

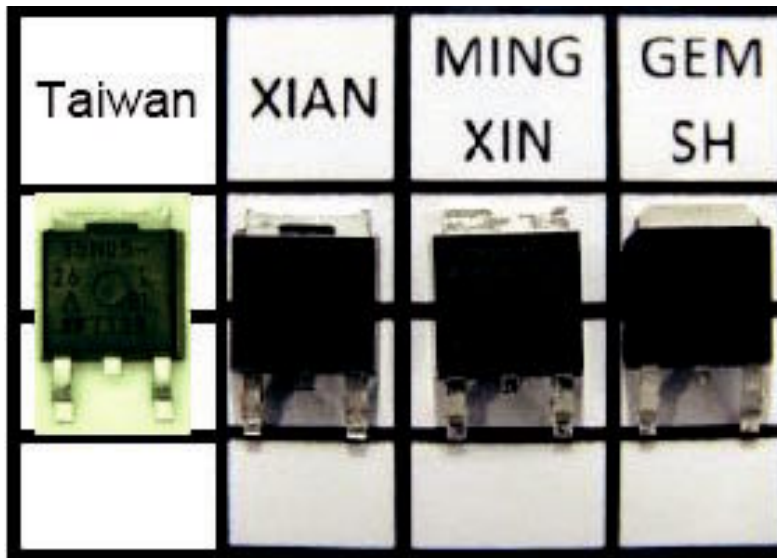

RECOMMENDED MINIMUM PADS FOR DPAK (TO-252)

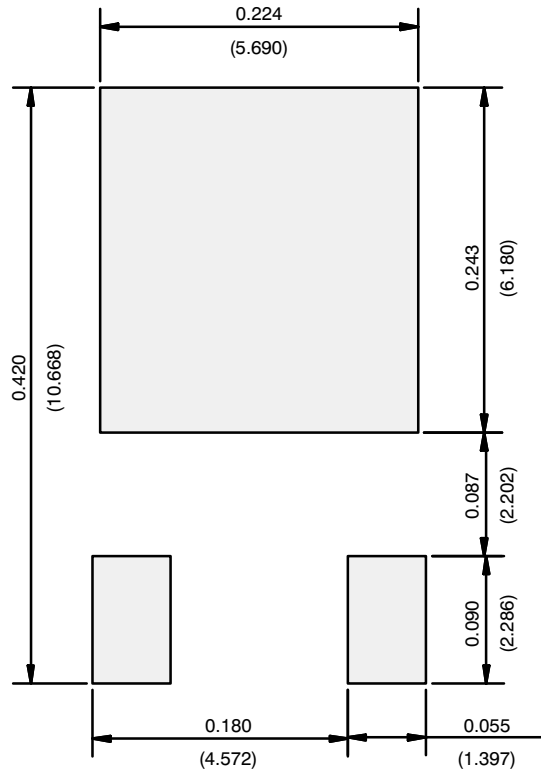

Recommended Minimum Pads
Dimensions in Inches/(mm)

[Return to Index](#)



Disclaimer

ALL PRODUCT, PRODUCT SPECIFICATIONS AND DATA ARE SUBJECT TO CHANGE WITHOUT NOTICE TO IMPROVE RELIABILITY, FUNCTION OR DESIGN OR OTHERWISE.

Vishay Intertechnology, Inc., its affiliates, agents, and employees, and all persons acting on its or their behalf (collectively, "Vishay"), disclaim any and all liability for any errors, inaccuracies or incompleteness contained in any datasheet or in any other disclosure relating to any product.

Vishay makes no warranty, representation or guarantee regarding the suitability of the products for any particular purpose or the continuing production of any product. To the maximum extent permitted by applicable law, Vishay disclaims (i) any and all liability arising out of the application or use of any product, (ii) any and all liability, including without limitation special, consequential or incidental damages, and (iii) any and all implied warranties, including warranties of fitness for particular purpose, non-infringement and merchantability.

Statements regarding the suitability of products for certain types of applications are based on Vishay's knowledge of typical requirements that are often placed on Vishay products in generic applications. Such statements are not binding statements about the suitability of products for a particular application. It is the customer's responsibility to validate that a particular product with the properties described in the product specification is suitable for use in a particular application. Parameters provided in datasheets and/or specifications may vary in different applications and performance may vary over time. All operating parameters, including typical parameters, must be validated for each customer application by the customer's technical experts. Product specifications do not expand or otherwise modify Vishay's terms and conditions of purchase, including but not limited to the warranty expressed therein.

Except as expressly indicated in writing, Vishay products are not designed for use in medical, life-saving, or life-sustaining applications or for any other application in which the failure of the Vishay product could result in personal injury or death. Customers using or selling Vishay products not expressly indicated for use in such applications do so at their own risk. Please contact authorized Vishay personnel to obtain written terms and conditions regarding products designed for such applications.

No license, express or implied, by estoppel or otherwise, to any intellectual property rights is granted by this document or by any conduct of Vishay. Product names and markings noted herein may be trademarks of their respective owners.

Material Category Policy

Vishay Intertechnology, Inc. hereby certifies that all its products that are identified as RoHS-Compliant fulfill the definitions and restrictions defined under Directive 2011/65/EU of The European Parliament and of the Council of June 8, 2011 on the restriction of the use of certain hazardous substances in electrical and electronic equipment (EEE) - recast, unless otherwise specified as non-compliant.

Please note that some Vishay documentation may still make reference to RoHS Directive 2002/95/EC. We confirm that all the products identified as being compliant to Directive 2002/95/EC conform to Directive 2011/65/EU.

Vishay Intertechnology, Inc. hereby certifies that all its products that are identified as Halogen-Free follow Halogen-Free requirements as per JEDEC JS709A standards. Please note that some Vishay documentation may still make reference to the IEC 61249-2-21 definition. We confirm that all the products identified as being compliant to IEC 61249-2-21 conform to JEDEC JS709A standards.