



design • manufacture • supply

Midas Components Limited
Electra House
32 Southtown Road
Great Yarmouth
Norfolk
NR31 0DU
England

Telephone
Fax
Email
Website

+44 (0)1493 602602
+44 (0)1493 665111
sales@midasdisplays.com
www.midasdisplays.com

Specification	
Part Number:	MCOT160128BY-RGBM
Version:	
Date:	



design • manufacture • supply

Midas Displays OLED Part Number System

MCO	B	21605	A	*	V	-	E	W	I	*		
1	2	3	4	5	6		7	8	9	10		
1	=	MCO:	Midas Displays OLED									
2	=	Blank:	B: COB (Chip on Board) T: TAB (Taped Automated Bonding)									
3	=	No of dots:	(e.g. 240064 = 240 x 64 dots)				(e.g. 21605 = 2 x 16 5mm C.H.)					
4	=	Series	A to Z									
5	=	Series Variant:	A to Z and 1 to 9 – see addendum									
6	=	Operating Temp Range:	A: -30+85° C		V: -40+80° C		Y: -40 +70° C		Z: -30+70° C			
			X: -40 +85° C									
7	=	Character Set:	Blank: Not Applicable E: Multi European Font Set (English/Japanese – Western European (K) – Cyrillic (R))									
8	=	Colour:	Y: Yellow		W: White		B: Blue		R: Red		G: Green	RGB: Full Colour
9	=	Interface:	P: Parallel		I: I ² C		S: SPI		M: Multi			
10	=	Voltage Variant:	e.g. 3 = 3v									

Contents

Contents	00
1. Basic Specifications	1~5
1.1 Display Specifications	1
1.2 Mechanical Specifications	1
1.3 Active Area / Memory Mapping & Pixel Construction	1
1.4 Mechanical Drawing	2
1.5 Pin Definition	3
1.6 Block Diagram	5
2. Absolute Maximum Ratings	6
3. Optics & Electrical Characteristics	7~11
3.1 Optics Characteristics	7
3.2 DC Characteristics	7
3.3 AC Characteristics	8
3.3.1 68XX-Series MPU Parallel Interface Timing Characteristics	8
3.3.2 80XX-Series MPU Parallel Interface Timing Characteristics	9
3.3.3 Serial Interface Timing Characteristics	10
3.3.4 RGB Interface Timing Characteristics	11
4. Functional Specification	12~13
4.1 Commands	12
4.2 Power down and Power up Sequence	12
4.2.1 Power up Sequence	12
4.2.2 Power down Sequence	12
4.3 Reset Circuit	12
4.4 Actual Application Example	13
5. Reliability	14
5.1 Contents of Reliability Tests	14
5.2 Failure Check Standard	14
6. Outgoing Quality Control Specifications	15~18
6.1 Environment Required	15
6.2 Sampling Plan	15
6.3 Criteria & Acceptable Quality Level	15
6.3.1 Cosmetic Check (Display Off) in Non-Active Area	15
6.3.2 Cosmetic Check (Display Off) in Active Area	17
6.3.3 Pattern Check (Display On) in Active Area	18
7. Package Specifications	19
8. Precautions When Using These OEL Display Modules	20~22
8.1 Handling Precautions	20

8.2	Storage Precautions.....	21
8.3	Designing Precautions	21
8.4	Precautions when disposing of the OEL display modules.....	22
8.5	Other Precautions.....	22



1. Basic Specifications

1.1 Display Specifications

- 1) Display Mode: Passive Matrix
- 2) Display Color: 262,144 Colors (Maximum)
- 3) Drive Duty: 1/128 Duty

1.2 Mechanical Specifications

- 1) Outline Drawing: According to the annexed outline drawing
- 2) Number of Pixels: 160 (RGB) × 128
- 3) Panel Size: 39.90 × 34.00 × 1.60 (mm)
- 4) Active Area: 33.575 × 26.864 (mm)
- 5) Pixel Pitch: 0.07 × 0.21 (mm)
- 6) Pixel Size: 0.045 × 0.194 (mm)
- 7) Weight: 4.55 (g)

1.3 Active Area / Memory Mapping & Pixel Construction

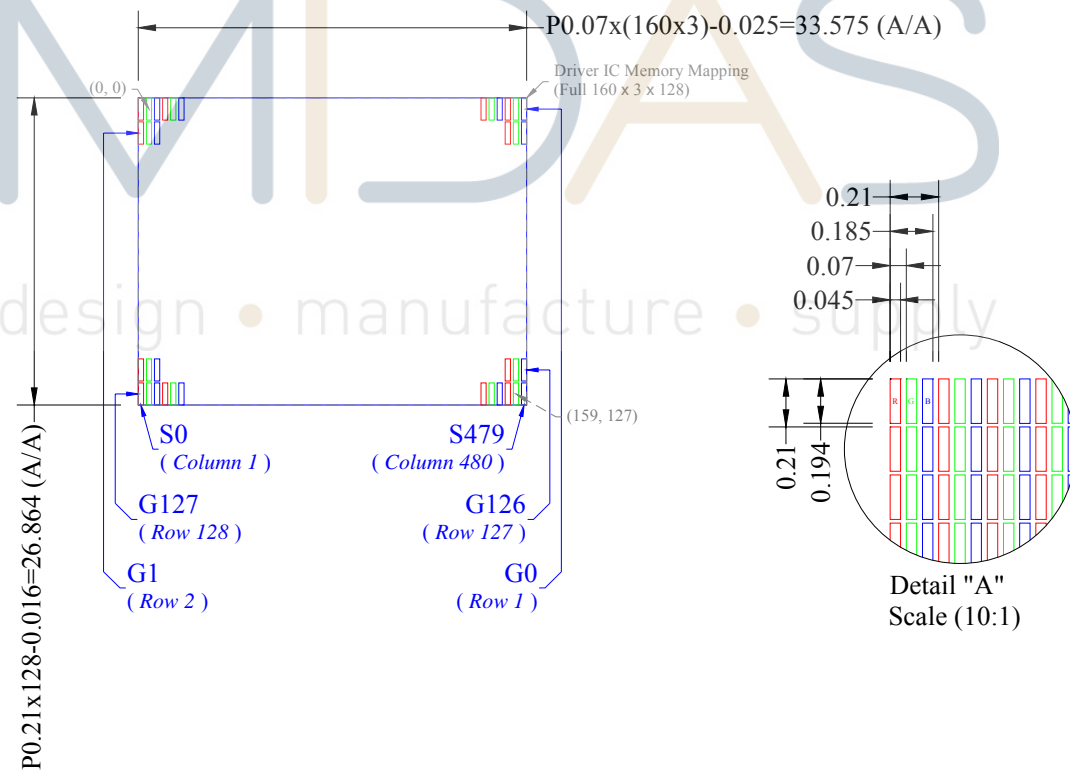

1.4 Mechanical Drawing

Item	Date	Date	Remark
A	20091110	20091110	Original Drawing

Remove Tape
t=0.15mm Max

Polarizer
t=0.2mm

Protective Film
30x10x0.055mm

Glue

3±0.5 (Stiffener)

-0.3±0.03

-0.80 Max

Contact Side

(Reference Mechanical Design)

Pin

1	SWH050
2	VS28H
3	WB01H
4	RR01P
5	RR02P
6	DS2A2
7	VS00A
8	VS00A
9	VSTKSCD
10	VSTKSK
11	DB7SK
12	DB7SK
13	D012LK
14	VS01A
15	PS
16	017
17	017
18	018
19	014
20	014
21	012
22	011
23	011
24	019
25	R5
26	R5
27	W19B
28	W19B
29	VSSD
30	VSSD
31	W01H
32	W01H
33	W01H
34	W01H
35	N.C (GND)

39.94±0.2 (Panel Size)

39.94±0.2 (Cap Size)

38.94±0.3 (Polarizer)

35.575 (V/A)

P0.07x(160x3)-0.025=33.575 (A/A)

P0.21x128-0.016=26.864 (A/A)

28.864 (V/A)

31±0.3 (Polarizer)

32±0.2 (Cap Size)

34±0.2 (Panel Size)

(48.5)

Active Area 1.69"
160(RGB) x 128 Pixels

(35.5)

(23.2)

(33.2)

(1.5)

(-2.26)

(42.7)

(8.7)

(5.5)

(1.6)

0.21

0.185

0.07

0.045

0.194

0.21

Detail "A"
Scale (10:1)

2-R0.5±0.05

30.50x(35-1)=7±0.05 (W0.35±0.03)

18±0.2

-30.68±0.1 (Alignment Hole)

32.68±0.2

(3.61)

2.85

4

5

10

14.5±0.2

"A"

0.5±0.5

(2.1)

(1.1)

0.5±0.5

"A"

0.5±0.5

(2.1)

(1.1)

0.5±0.5

"A"

0.5±0.5

(2.1)

(1.1)

0.5±0.5

"A"

0.5±0.5

(2.1)

(1.1)

0.5±0.5

"A"

Notes:

- Driver IC: SEPS25
- Size: 1850um
- COF number: SEPS25F00/ UT-0825-F01
- Interface: 8-94bit 80XXX Parallel 4-wire SPI, 6-bit RGB I/F
- General Tolerance: ±0.30
- The total thickness (1.70 Max) is without polarizer protective film & remove tape. The actual assembled total thickness with above materials should be 1.95 Max.

Customer Approval	Signature		
Rev.	A		
Material	Soda Lime / Polyimide		
Title	MCO1160128BY-RGBM Folding Type OEL Display Module		
Unit	mm		
Dimension	±0.3		
Tolerance	G		
Angle	≠I		
Drawn	E.E.	Panel / E.	P.M.
By	Humphrey Lin	Scan Lai	Cherry Lin
Date	20091110	20091110	20091110
Sheet	1 of 1		
Size	A3		

1.5 Pin Definition

Pin Number	Symbol	Type	Function
Power Supply			
31	VDD.	P	Power Supply for Logic Circuit This is a voltage supply pin. It must be connected to external source.
8	VDDIO	P	Power Supply for Interface Logic Level This is a voltage supply pin. It should be match with MCU interface voltage level. It must always be equal or lower than VDD.
30	VSS	P	Ground of Logic Circuit A reference for the logic pins. It must be connected to external ground.
3, 33	VDDH	P	Power Supply for OEL Panel This is the most positive voltage supply pin of the chip. It must be connected to external source.
2, 34 4, 32	VSDH VSSH	P	Ground of OEL Panel These are the ground pins for analog circuits. It must be connected to external ground. VSDH: Segment (Data Driver) VSSH: Common (Scan Driver)
Driver			
5	IREF	I/O	Current Reference for Brightness Adjustment This pin is segment (data) current reference pin. A 68kΩ resistor should be connected between this pin and VSS.
7 6	OSCA1 OSCA2	I O	Fine Adjustment for Oscillation The frequency is controlled by external 5.1kΩ resistor between OSCA1 and OSCA2. The oscillator signal is used for system clock generation. When the external clock mode is selected, OSCA1 is used external clock input.
RGB Interface			
9	VSYNCO	O	Vertical Synchronization Triggering Signal
10	VSYNC	I	Vertical Synchronization Input
11	HSYNC	I	Horizontal Synchronization Input
12	DOTCLK	I	Dot Clock Input
13	ENABLE	I	Video Enable Input
MCU Interface			
14	CPU	I	Select the CPU Type Low: 80XX-Series MCU High: 68XX-Series MCU.
15	PS	I	Select Parallel/Serial Interface Type Low: Serial Interface High: Parallel Interface
29	RESETB	I	Power Reset for Controller and Driver This pin is reset signal input. When the pin is low, initialization of the chip is executed.

1.5 Pin Definition (Continued)

Pin Number	Symbol	Type	Function						
MCU Interface (Continued)									
26	CSB	I	Chip Select Low: SEPS525 is selected and can be accessed. High: SEPS525 is not selected and cannot be accessed.						
25	RS	I	Data/Command Control Low: Command High: Parameter/Data						
27	RDB	I	Read or Read/Write Enable 68XX Parallel Interface: Bus Enabled Strobe (Active High) 80XX Parallel Interface: Read Strobe Signal (Active Low) While using SPI, it must be connected to VDD or VSS.						
28	WRB	I	Write or Read/Write Select 68XX Parallel Interface: Read (Low)/Write (High) Select 80XX Parallel Interface: Write Strobe Signal (Active Low) While using SPI, it must be connected to VDD or VSS.						
16~24	D17~D9	I/O	Host Data Input/Output Bus These pins are 9-bit bi-directional data bus to be connected to the microprocessor's data bus.						
			<table border="1"> <thead> <tr> <th>PS</th> <th>Description</th> </tr> </thead> <tbody> <tr> <td>0</td> <td>D[17]/SCL: Synchronous Clock Input D[16]/SDI: Serial Data Input D[15]/SDO: Serial Data Output</td> </tr> <tr> <td>1</td> <td>9-bit Bus: D[17:9] 8-bit Bus: D[17:10]</td> </tr> </tbody> </table>	PS	Description	0	D[17]/SCL: Synchronous Clock Input D[16]/SDI: Serial Data Input D[15]/SDO: Serial Data Output	1	9-bit Bus: D[17:9] 8-bit Bus: D[17:10]
			PS	Description					
0	D[17]/SCL: Synchronous Clock Input D[16]/SDI: Serial Data Input D[15]/SDO: Serial Data Output								
1	9-bit Bus: D[17:9] 8-bit Bus: D[17:10]								
While using SPI, the unused pins must be connected to VSS.									
Reserve									
1, 35	N.C. (GND)	-	Reserved Pin (Supporting Pin) The supporting pins can reduce the influences from stresses on the function pins. These pins must be connected to external ground.						

1.6 Block Diagram

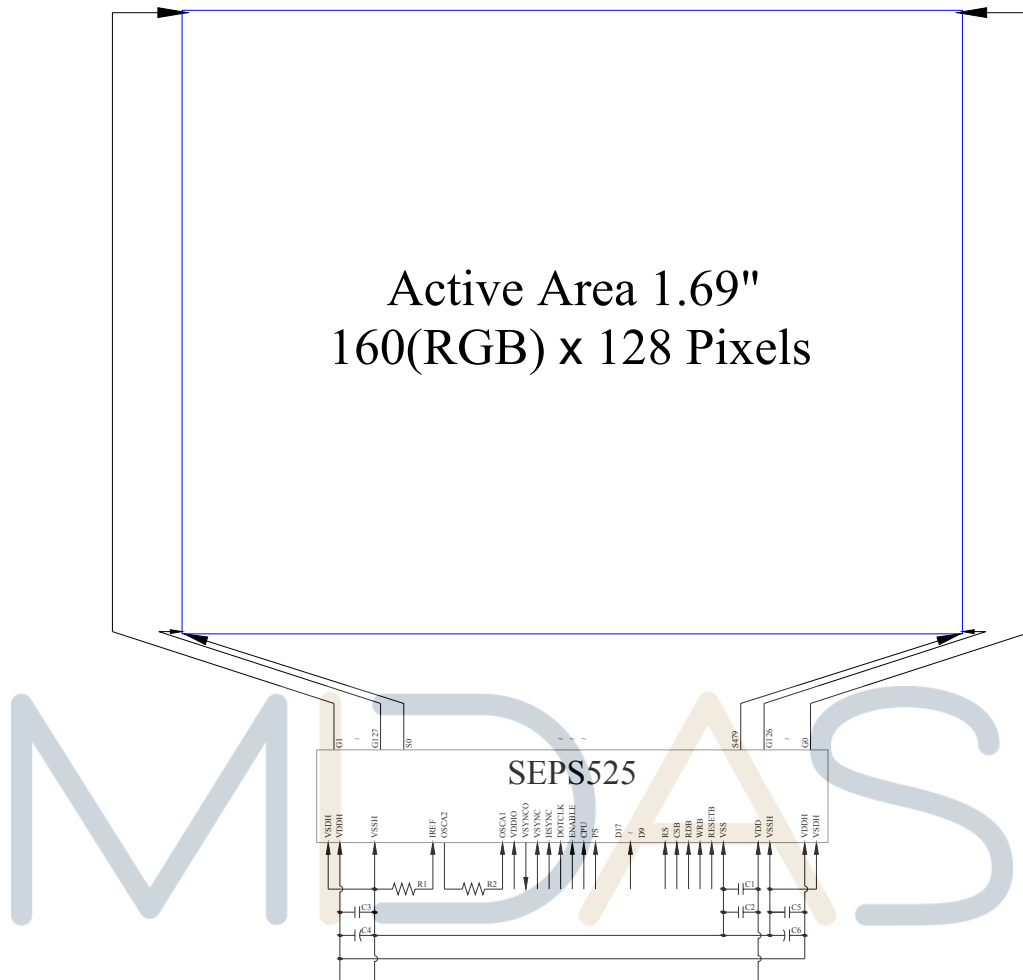

MCU Interface Selection: CPU, PS
Pins connected to MCU interface: D17~D9, RS, CSB, RDB, WRB, and RESETB
Pins connected to RGB interface: D17~D12, VSYNC, HSYNC, DOTCLK, and ENABLE

C1, C3, C5: 0.1 μ F
C2: 4.7 μ F
C4, C6: 4.7 μ F / 25V Tantalum Capacitor
R1: 68k Ω
R2: 5.1k Ω

2. Absolute Maximum Ratings

Parameter	Symbol	Min	Max	Unit	Notes
Supply Voltage for Logic	V _{DD}	-0.3	4	V	1, 2
Supply Voltage for I/O Pins	V _{DDIO}	-0.3	4	V	1, 2
Supply Voltage for Display	V _{DDH}	-0.3	16	V	1, 2
Operating Temperature	T _{OP}	-40	70	°C	-
Storage Temperature	T _{STG}	-40	80	°C	-

Life Time 50cd/m² , 30,000 hours (TYP) Note3.

Note 1: All the above voltages are on the basis of “VSS = 0V”.

Note 2: When this module is used beyond the above absolute maximum ratings, permanent breakage of the module may occur. Also, for normal operations, it is desirable to use this module under the conditions according to Section 3. “Optics & Electrical Characteristics”. If this module is used beyond these conditions, malfunctioning of the module can occur and the reliability of the module may deteriorate.

Note 3: V_{CC} = 14V, T_a = 25°C, 50% Checkerboard.

Software configuration follows Section 4.4 Initialization.

End of lifetime is specified as 50% of initial brightness reached. The average operating lifetime at room temperature is estimated by the accelerated operation at high temperature conditions.

design • manufacture • supply

3. Optics & Electrical Characteristics

3.1 Optics Characteristics

Characteristics	Symbol	Conditions	Min	Typ	Max	Unit
Brightness (White)	L_{br}	Note 4	60	75	-	cd/m ²
C.I.E. (White)	(x)	C.I.E. 1931	0.26	0.30	0.34	
	(y)		0.29	0.33	0.37	
C.I.E. (Red)	(x)	C.I.E. 1931	0.60	0.64	0.68	
	(y)		0.30	0.34	0.38	
C.I.E. (Green)	(x)	C.I.E. 1931	0.27	0.31	0.35	
	(y)		0.58	0.62	0.66	
C.I.E. (Blue)	(x)	C.I.E. 1931	0.10	0.14	0.18	
	(y)		0.12	0.16	0.20	
Dark Room Contrast	CR		-	>2000:1	-	
View Angle			>160	-	-	degree

* Optical measurement taken at $V_{DD} = 2.8V$, $V_{DDH} = 14V$.
Software configuration follows Section 4.4 Initialization.

3.2 DC Characteristics

Characteristics	Symbol	Conditions	Min	Typ	Max	Unit
Supply Voltage for Logic	V_{DD}		2.6	2.8	3.3	V
Supply Voltage for I/O Pins	V_{DDIO}		1.6	2.8	3.3	V
Supply Voltage for Display	V_{DDH}	Note 4	13.5	14	14.5	V
High Level Input	V_{IH}		$0.8 \times V_{DD}$	-	V_{DD}	V
Low Level Input	V_{IL}		0	-	0.4	V
High Level Output	V_{OH1}	$I_{OH} = -0.4mA$	$V_{DD}-0.4$	-		V
	V_{OH2}	$I_{OH} = -0.4mA$				
Low Level Output	V_{OL1}	$I_{OL} = -0.1mA$		-	0.4	V
	V_{OL2}	$I_{OL} = -0.1mA$				
Operating Current for V_{DD}	I_{DD}		-	2.5	3.5	mA
Operating Current for V_{DDH}	I_{DDH}	Note 5	-	14.9	18.6	mA
		Note 6	-	26.2	32.8	mA

Note 4: Brightness (L_{br}) and Supply Voltage for Display (V_{DDH}) are subject to the change of the panel characteristics and the customer's request.

Note 5: $V_{DD} = 2.8V$, $V_{DDH} = 14V$, 50% Display Area Turn on.

Note 6: $V_{DD} = 2.8V$, $V_{DDH} = 14V$, 100% Display Area Turn on.

* Software configuration follows Section 4.4 Initialization.

3.3 AC Characteristics

3.3.1 68XX-Series MPU Parallel Interface Timing Characteristics:

($V_{DD} = 2.8V$, $T_a = 25^\circ C$)

Symbol	Description	Min	Max	Unit	Port	
t_{AH6}	Address Setup Timing	(Read)	10	-	ns	CSB RS
		(Write)	5	-	ns	
t_{AS6}	Address Hold Timing	(Read)	10	-	ns	
		(Write)	5	-	ns	
t_{CYC6}	System Cycle Timing	200	-	ns	E	
t_{ELR6}	Read "L" Pulse Width	90	-	ns		
t_{EHR6}	Read "H" Pulse Width	90	-	ns		
t_{CYC6}	System Cycle Timing	100	-	ns		
t_{ELW6}	Write "L" Pulse Width	45	-	ns		
t_{EHW6}	Write "H" Pulse Width	45	-	ns		
t_{RDD6}	Read Data Output Delay Time * $CL = 15pF$	0	70	ns	D[17:9]	
t_{RDH6}	Data Hold Timing	0	70	ns		
t_{DS6}	Data Setup Timing	40	-	ns		
t_{DH6}	Data Hold Timing	10	-	ns		

* All the timing reference is 10% and 90% of V_{DD} .

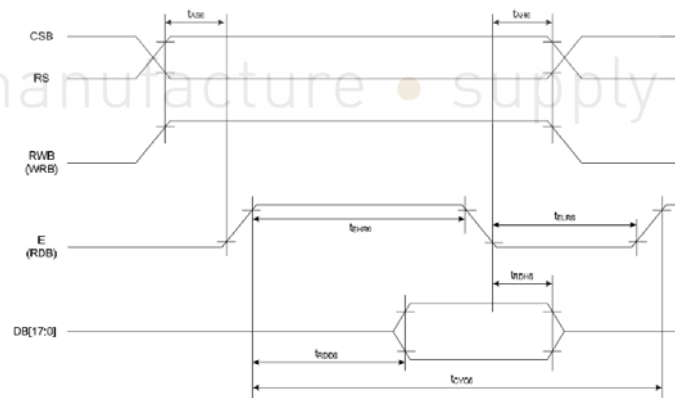

(Read Timing)

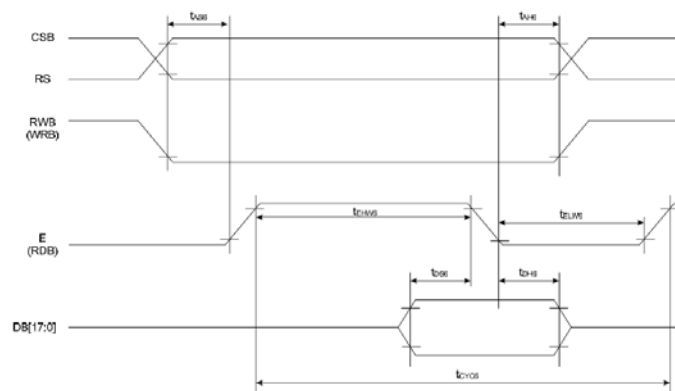

(Write Timing)

3.3.2 80XX-Series MPU Parallel Interface Timing Characteristics:

($V_{DD} = 2.8V$, $T_a = 25^\circ C$)

Symbol	Description	Min	Max	Unit	Port
t_{AS8}	Address Setup Timing	5	-	ns	CSB RS
t_{AH8}	Address Hold Timing	5	-	ns	
t_{CYC8}	System Cycle Timing	200	-	ns	RDB
t_{RDLR8}	Read "L" Pulse Width	90	-	ns	
t_{RDHR8}	Read "H" Pulse Width	90	-	ns	
t_{CYC8}	System Cycle Timing	100	-	ns	WRB
t_{WRLW8}	Write "L" Pulse Width	45	-	ns	
t_{WRHW8}	Write "H" Pulse Width	45	-	ns	
t_{RDD8}	Read Data Output Delay Time	-	60	ns	D[17:9]
t_{RDH8}	Data Hold Timing	0	60	ns	
t_{DS8}	Data Setup Timing	30	-	ns	
t_{DH8}	Data Hold Timing	10	-	ns	

* All the timing reference is 10% and 90% of V_{DD} .

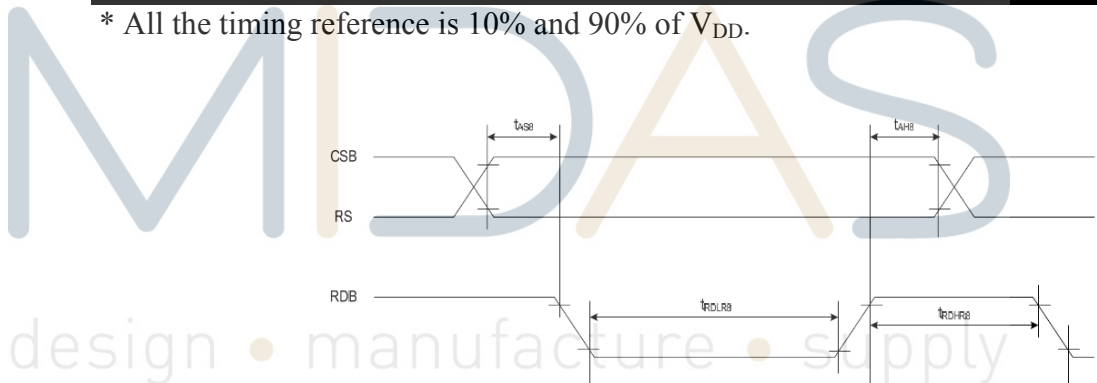

(Read Timing)

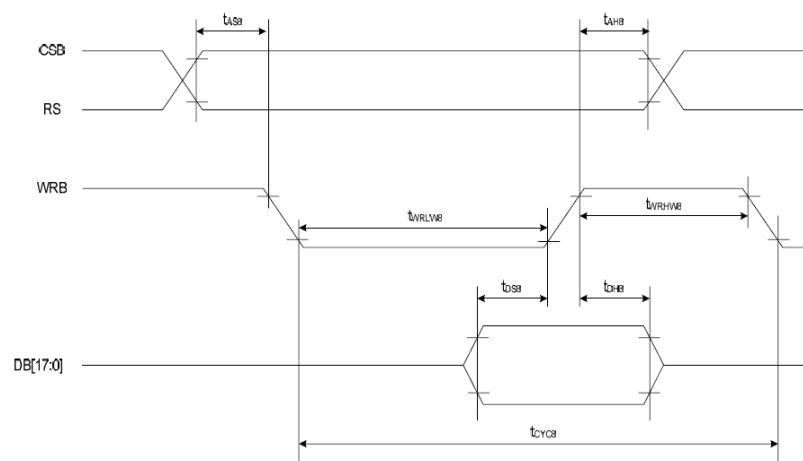

(Write Timing)

3.3.3 Serial Interface Timing Characteristics:

($V_{DD} = 2.8V$, $T_a = 25^\circ C$)

Symbol	Item	Min	Max	Unit	Port
t_{CYCS}	Serial Clock Cycle	60	-	ns	SCL
t_{SHW}	SCL "L" Pulse Width	25	-	ns	
t_{SLW}	SCL "H" Pulse Width	25	-	ns	
t_{DSS}	Data Setup Timing	25	-	ns	SDI
t_{DHS}	Data Hold Timing	25	-	ns	
t_{CSS}	CSB-SCL Timing	25	-	ns	CSB
t_{CSH}	CSB-Hold Timing	25	-	ns	
t_{RSS}	RS-SCL Timing	25	-	ns	RS
t_{RSH}	RS-Hold Timing	25	-	ns	

* All the timing reference is 10% and 90% of V_{DD} .

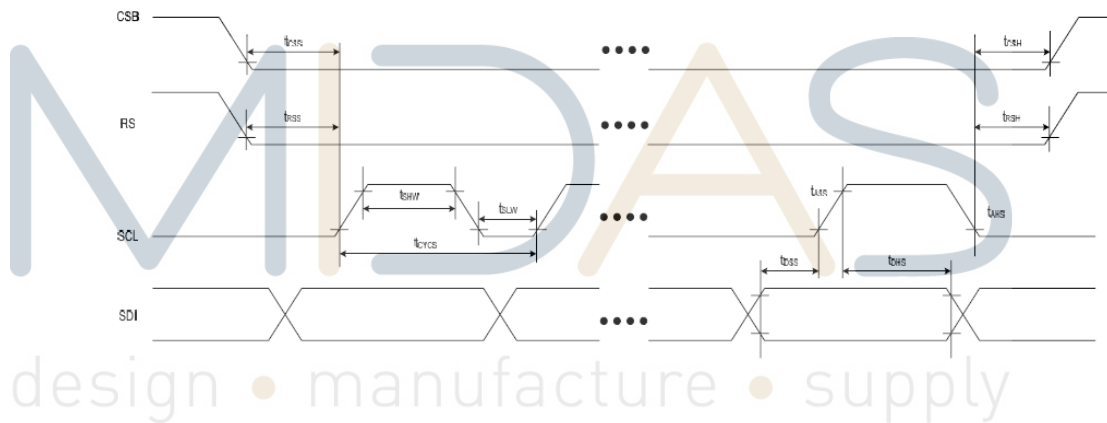

3.3.4 RGB Interface Timing Characteristics:

($V_{DD} = 2.8V$, $T_a = 25^\circ C$)

Symbol	Item	Min	Max	Unit	Port
t_{DCYC}	Dot Clock Cycle	100	-	ns	DOTCLK
t_{DLW}	Dot "L" Pulse Width	50	-	ns	
t_{DHW}	Dot "H" Pulse Width	50	-	ns	
t_{DS}	Data Setup Timing	5	-	ns	D[17:12]
t_{DH}	Data Hold Timing	5	-	ns	
t_{VLW}	Vsync Pulse Width	1	-	DOTCLK	VSYNC
t_{HLW}	Hsync Pulse Width	1	-	DOTCLK	HSYNC

* All the timing reference is 10% and 90% of V_{DD} .

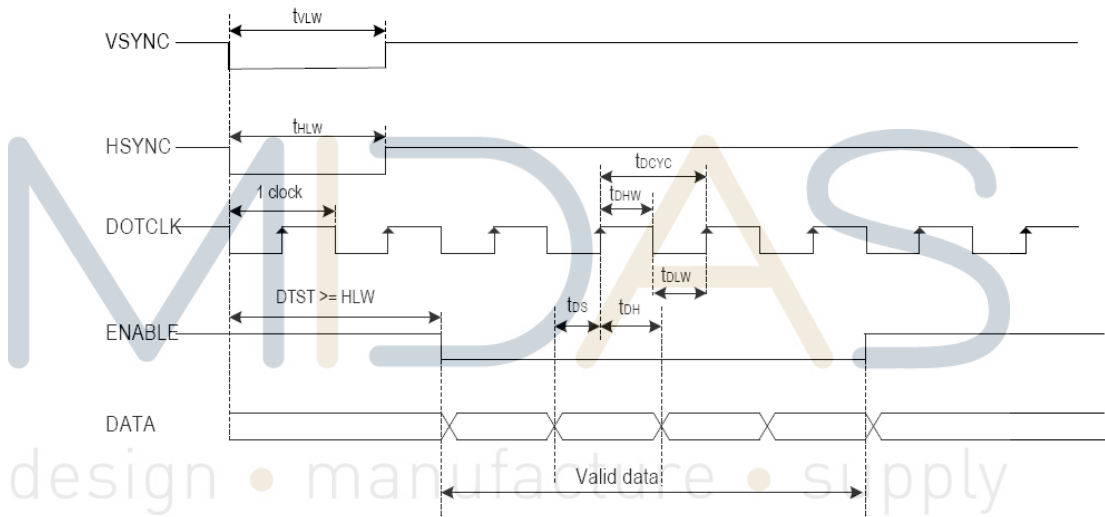

DTST: Setup Time for Data Transmission

* VSYNC, HSYNC, ENABLE, and D[17:12] should be transmitted by 3 clocks for one pixel (RGB).

4. Functional Specification

4.1. Commands

Refer to the Technical Manual for the SEPS525

4.2 Power down and Power up Sequence

To protect OEL panel and extend the panel life time, the driver IC power up/down routine should include a delay period between high voltage and low voltage power sources during turn on/off. It gives the OEL panel enough time to complete the action of charge and discharge before/after the operation.

4.2.1 Power up Sequence:

1. Power up V_{DD} / V_{DDIO}
2. Send Display off command
3. Initialization
4. Clear Screen
5. Power up V_{DDH}
6. Delay 100ms
(when V_{DDH} is stable)
7. Send Display on command

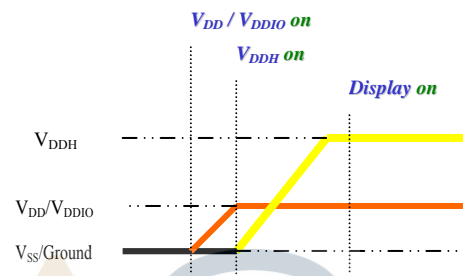

4.2.2 Power down Sequence:

1. Send Display off command
2. Power down V_{DDH}
3. Delay 100ms
(when V_{DDH} is reach 0 and panel is completely discharges)
4. Power down V_{DD} / V_{DDIO}

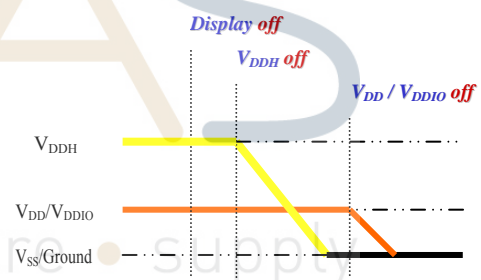

4.3 Reset Circuit

When RESETB input is low, the chip is initialized with the following status:

1. Frame Frequency: 90Hz
2. Oscillation: Internal Oscillator On
3. DDRAM Write Horizontal Address: MX1 = 0x00, MX2 = 0x9F
4. DDRAM Write Vertical Address: MY1 = 0x00, MY2 = 0x7F
5. Display Data RAM Write: HC = 1, VC = 1, HV = 0
6. RGB Data Swap: Off
7. Row Scan Shift Direction: G0, G1, ..., G126, G127
8. Column Data Shift Direction: S0, S1, ..., S478, S479
9. Display On/Off: Off
10. Panel Display Size: FX1 = 0x00, FX2 = 0x9F, FY1 = 0x00, FY1 = 0x7F
11. Display Data RAM Read Column/Row Address: FAC = 0x00, FAR = 0x00
12. Precharge Time (R/G/B): 0 Clock
13. Precharge Current (R/G/B): 0 μ A
14. Driving Current (R/G/B): 0 μ A

4.4 Actual Application Example

Command usage and explanation of an actual example

<Initialization>

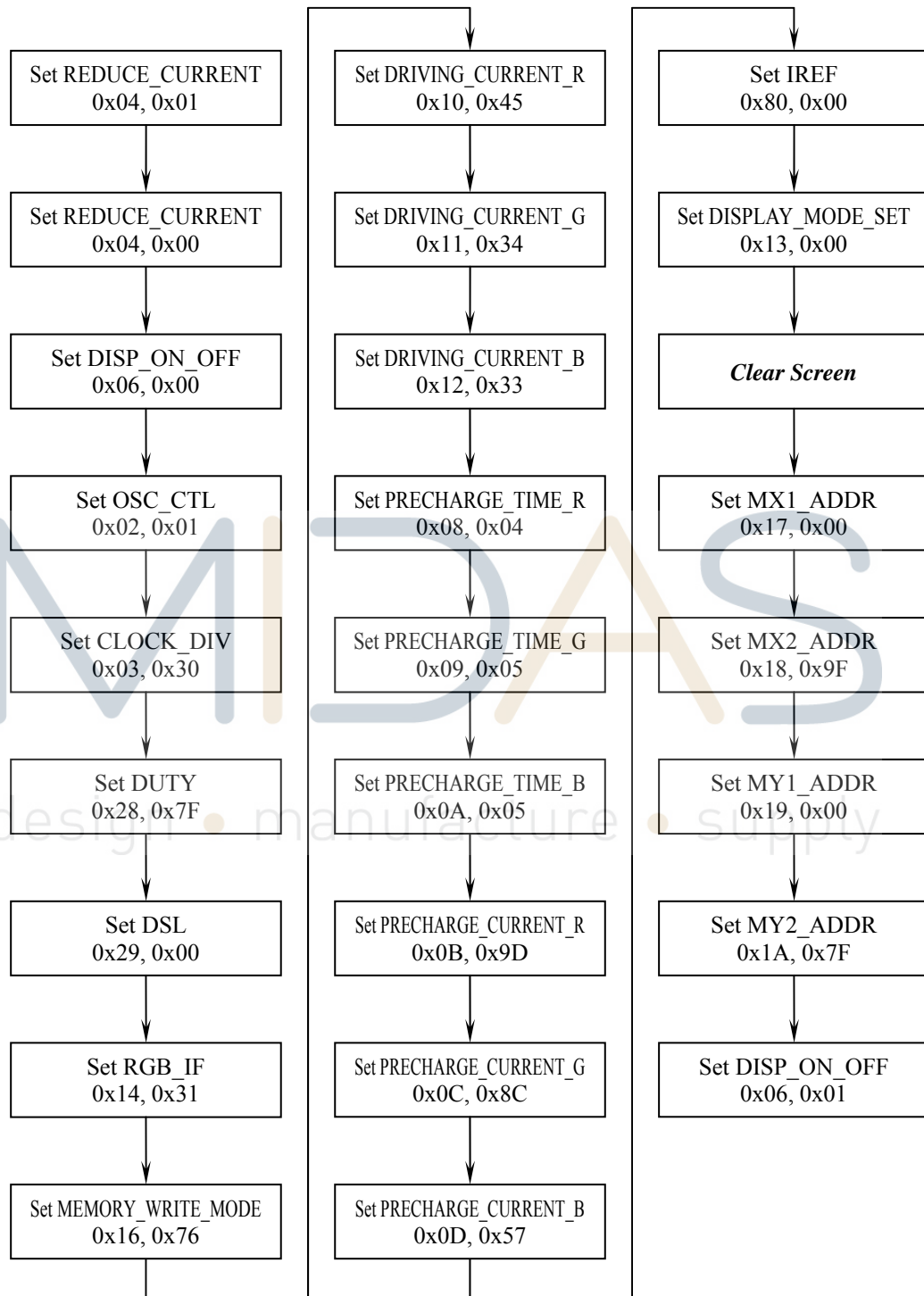

If the noise is accidentally occurred at the displaying window during the operation, please reset the display in order to recover the display function.

5. Reliability

5.1 Contents of Reliability Tests

Item	Conditions	Criteria
High Temperature Operation	70°C, 240 hrs	The operational functions work.
Low Temperature Operation	-40°C, 240 hrs	
High Temperature Storage	80°C, 240 hrs	
Low Temperature Storage	-40°C, 240 hrs	
High Temperature/Humidity Operation	60°C, 90% RH, 120 hrs	
Thermal Shock	-40°C ⇔ 85°C, 24 cycles 60 mins dwell	

- * The samples used for the above tests do not include polarizer.
- * No moisture condensation is observed during tests.

5.2 Failure Check Standard

After the completion of the described reliability test, the samples were left at room temperature for 2 hrs prior to conducting the failure test at 23±5°C; 55±15% RH.

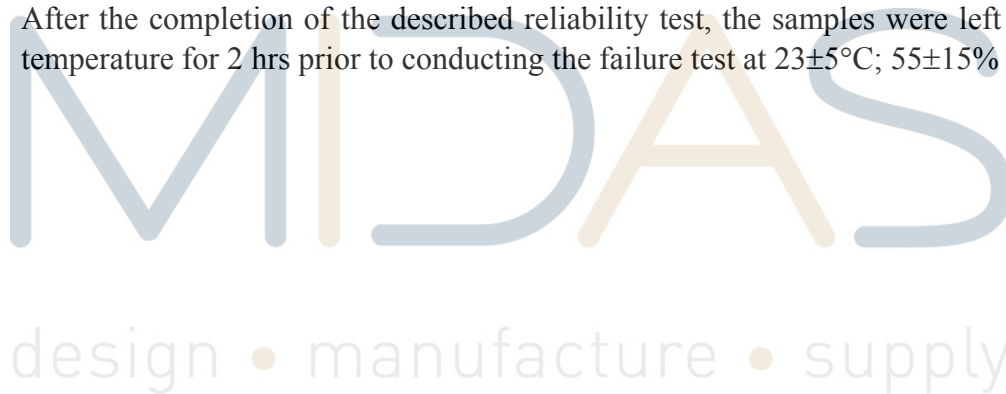

6. Outgoing Quality Control Specifications

6.1 Environment Required

Customer's test & measurement are required to be conducted under the following conditions:

Temperature:	$23 \pm 5^{\circ}\text{C}$
Humidity:	$55 \pm 15 \% \text{RH}$
Fluorescent Lamp:	30W
Distance between the Panel & Lamp:	$\geq 50 \text{ cm}$
Distance between the Panel & Eyes of the Inspector:	$\geq 30 \text{ cm}$
Finger glove (or finger cover) must be worn by the inspector.	
Inspection table or jig must be anti-electrostatic.	

6.2 Sampling Plan

Level II, Normal Inspection, Single Sampling, MIL-STD-105E



6.3 Criteria & Acceptable Quality Level

Partition	AQL	Definition
Major	0.65	Defects in Pattern Check (Display On)
Minor	1.0	Defects in Cosmetic Check (Display Off)

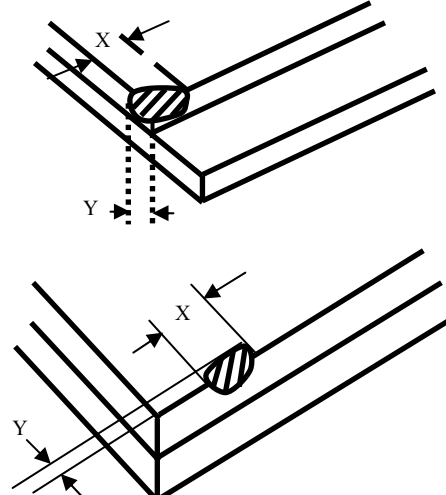
6.3.1 Cosmetic Check (Display Off) in Non-Active Area

Check Item	Classification	Criteria
Panel General Chipping	Minor	<p>$X > 6 \text{ mm}$ (Along with Edge) $Y > 1 \text{ mm}$ (Perpendicular to edge)</p> 

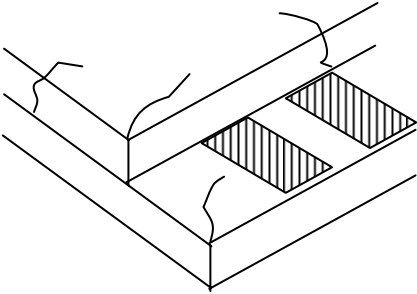
6.3.1 Cosmetic Check (Display Off) in Non-Active Area (Continued)

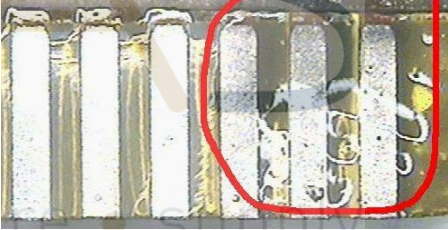
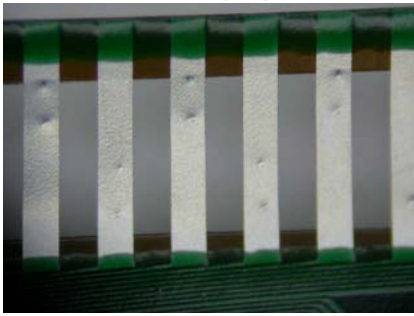
Check Item	Classification	Criteria
Panel Crack	Minor	<p>Any crack is not allowable.</p> 
Copper Exposed (Even Pin or Film)	Minor	<p>Not Allowable by Naked Eye Inspection</p>
Film or Trace Damage	Minor	
Glue or Contamination on Pin (Couldn't Be Removed by Alcohol)	Minor	
Terminal Lead Prober Mark	Acceptable	
Ink Marking on Back Side of panel (Exclude on Film)	Acceptable	<p>Ignore for Any</p>

6.3.2 Cosmetic Check (Display Off) in Active Area

It is recommended to execute in clear room environment (class 10k) if actual in necessary.

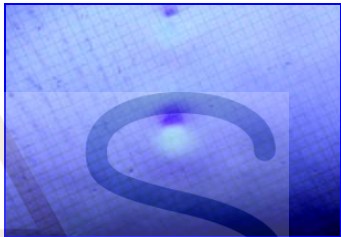
Check Item	Classification	Criteria
Any Dirt & Scratch on Polarizer's Protective Film	Acceptable	Ignore for not Affect the Polarizer
Scratches, Fiber, Line-Shape Defect (On Polarizer)	Minor	$W \leq 0.1$ Ignore $W > 0.1, L \leq 2$ $n \leq 1$ $L > 2$ $n = 0$
Dirt, Black Spot, Foreign Material, (On Polarizer)	Minor	$\Phi \leq 0.1$ Ignore $0.1 < \Phi \leq 0.25$ $n \leq 1$ $0.25 < \Phi$ $n = 0$
Dent, Bubbles, White spot (Any Transparent Spot on Polarizer)	Minor	$\Phi \leq 0.5$ → Ignore if no Influence on Display $0.5 < \Phi$ $n = 0$ 
Fingerprint, Flow Mark (On Polarizer)	Minor	Not Allowable

* Protective film should not be tear off when cosmetic check.

** Definition of W & L & Φ (Unit: mm): $\Phi = (a + b) / 2$

design • manufacture • supply

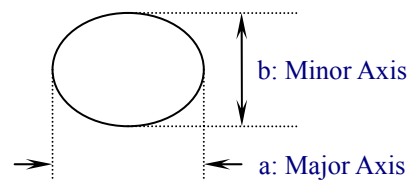
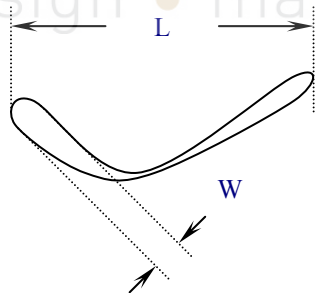

6.3.3 Pattern Check (Display On) in Active Area

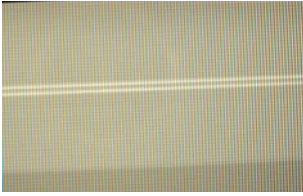
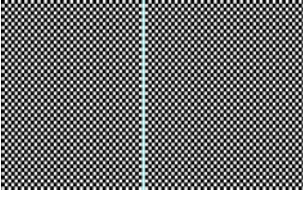
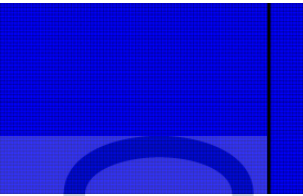
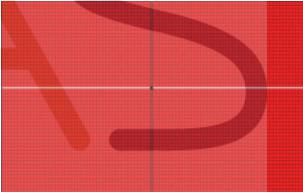
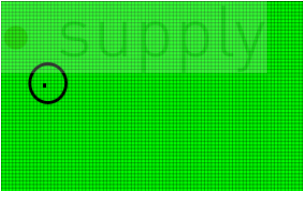
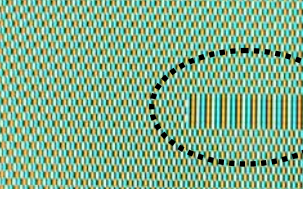
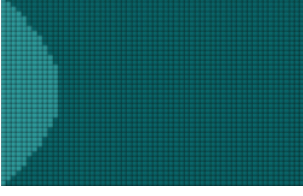
Check Item	Classification	Criteria
No Display	Major	Not allowable
Bright Line	Major	
Missed Line	Major	 
Pixel Short	Major	
Darker Pixel	Major	
Wrong Display	Major	
Un-Uniform (Luminance Variation within a Display)	Major	

7. Package Specifications

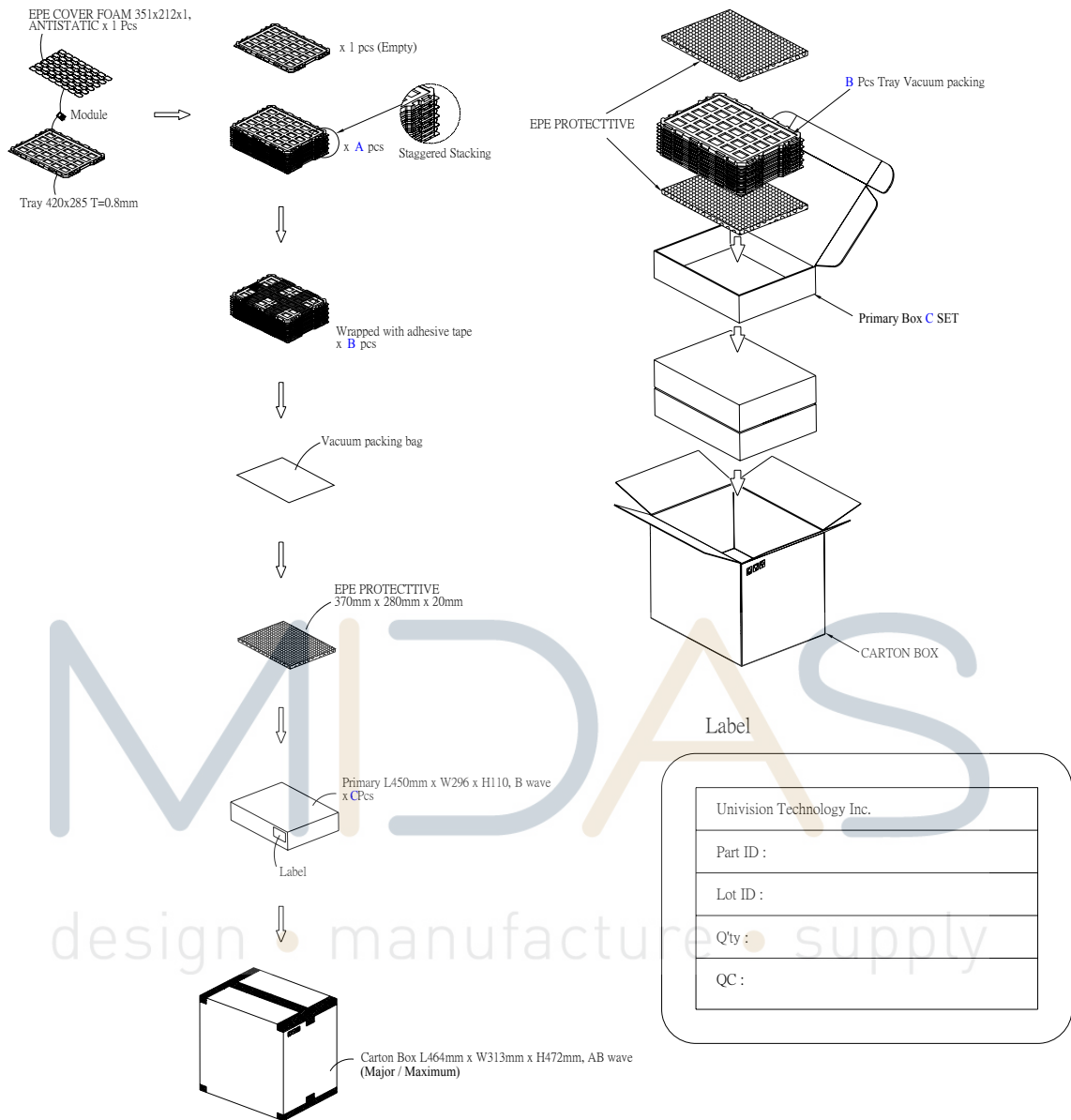

Item	Quantity
Holding Trays (A)	15 per Primary Box
Total Trays (B)	16 per Primary Box (Including 1 Empty Tray)
Primary Box (C)	1~4 per Carton (4 as Major / Maximum)

8. Precautions When Using These OEL Display Modules

8.1 Handling Precautions

- 1) Since the display panel is being made of glass, do not apply mechanical impacts such as dropping from a high position.
- 2) If the display panel is broken by some accident and the internal organic substance leaks out, be careful not to inhale nor lick the organic substance.
- 3) If pressure is applied to the display surface or its neighborhood of the OEL display module, the cell structure may be damaged and be careful not to apply pressure to these sections.
- 4) The polarizer covering the surface of the OEL display module is soft and easily scratched. Please be careful when handling the OEL display module.
- 5) When the surface of the polarizer of the OEL display module has soil, clean the surface. It takes advantage of by using following adhesion tape.

* Scotch Mending Tape No. 810 or an equivalent

Never try to breathe upon the soiled surface nor wipe the surface using cloth containing solvent such as ethyl alcohol, since the surface of the polarizer will become cloudy.

Also, pay attention that the following liquid and solvent may spoil the polarizer:

* Water

* Ketone

* Aromatic Solvents

- 6) Hold the OEL display module very carefully when placing the OEL display module onto/into any device. Do not apply excessive stress or pressure to the OEL module. And, do not over bend the film with electrode layouts. These stresses will influence the display performance. Also, secure sufficient rigidity for the outer cases.

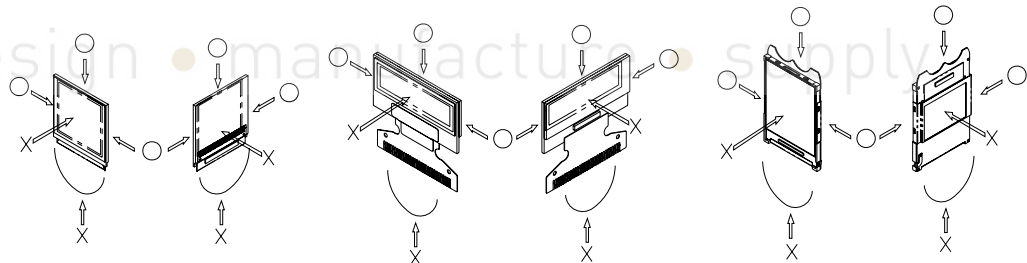

- 7) Do not apply stress to the LSI chips and the surrounding molded sections.
- 8) Do not disassemble nor modify the OEL display module.
- 9) Do not apply input signals while the logic power is off.
- 10) Pay sufficient attention to the working environments when handing OEL display modules to prevent occurrence of element breakage accidents by static electricity.
 - * Be sure to make human body grounding when handling OEL display modules.
 - * Be sure to ground tools to use or assembly such as soldering irons.
 - * To suppress generation of static electricity, avoid carrying out assembly work under dry environments.
 - * Protective film is being applied to the surface of the display panel of the OEL display module. Be careful since static electricity may be generated when exfoliating the protective film.
- 11) Protection film is being applied to the surface of the display panel and removes

the protection film before assembling it. At this time, if the OEL display module has been stored for a long period of time, residue adhesive material of the protection film may remain on the surface of the display panel after removed of the film. In such case, remove the residue material by the method introduced in the above Section 5).

- 12) If electric current is applied when the OEL display module is being dewed or when it is placed under high humidity environments, the electrodes may be corroded and be careful to avoid the above.

8.2 Storage Precautions

- 1) When storing OEL display modules, put them in static electricity preventive bags avoiding exposure to direct sun light nor to lights of fluorescent lamps, etc. and, also, avoiding high temperature and high humidity environments or low temperature (less than 0°C) environments. We recommend you to store these modules in the packaged state when they were shipped from Midas Displays. At that time, be careful not to let water drops adhere to the packages or bags nor let dewing occur with them.
- 2) If electric current is applied when water drops are adhering to the surface of the OEL display module, when the OEL display module is being dewed or when it is placed under high humidity environments, the electrodes may be corroded and be careful about the above.

8.3 Designing Precautions

- 1) The absolute maximum ratings are the ratings which cannot be exceeded for OEL display module, and if these values are exceeded, panel damage may be happen.
- 2) To prevent occurrence of malfunctioning by noise, pay attention to satisfy the VIL and VIH specifications and, at the same time, to make the signal line cable as short as possible.
- 3) We recommend you to install excess current preventive unit (fuses, etc.) to the power circuit (VDD). (Recommend value: 0.5A)
- 4) Pay sufficient attention to avoid occurrence of mutual noise interference with the neighboring devices.
- 5) As for EMI, take necessary measures on the equipment side basically.
- 6) When fastening the OEL display module, fasten the external plastic housing section.
- 7) If power supply to the OEL display module is forcibly shut down by such errors as taking out the main battery while the OEL display panel is in operation, we cannot guarantee the quality of this OEL display module.
- 8) The electric potential to be connected to the rear face of the IC chip should be as follows: SEPS525
* Connection (contact) to any other potential than the above may lead to rupture of the IC.

8.4 Precautions when disposing of the OEL display modules

- 1) Request the qualified companies to handle industrial wastes when disposing of the OEL display modules. Or, when burning them, be sure to observe the environmental and hygienic laws and regulations.

8.5 Other Precautions

- 1) When an OEL display module is operated for a long of time with fixed pattern may remain as an after image or slight contrast deviation may occur. Nonetheless, if the operation is interrupted and left unused for a while, normal state can be restored. Also, there will be no problem in the reliability of the module.
- 2) To protect OEL display modules from performance drops by static electricity rapture, etc., do not touch the following sections whenever possible while handling the OEL display modules.
 - * Pins and electrodes
 - * Pattern layouts such as the COF
- 3) With this OEL display module, the OEL driver is being exposed. Generally speaking, semiconductor elements change their characteristics when light is radiated according to the principle of the solar battery. Consequently, if this OEL driver is exposed to light, malfunctioning may occur.
 - * Design the product and installation method so that the OEL driver may be shielded from light in actual usage.
 - * Design the product and installation method so that the OEL driver may be shielded from light during the inspection processes.
- 4) Although this OEL display module stores the operation state data by the commands and the indication data, when excessive external noise, etc. enters into the module, the internal status may be changed. It therefore is necessary to take appropriate measures to suppress noise generation or to protect from influences of noise on the system design.
- 5) We recommend you to construct its software to make periodical refreshment of the operation statuses (re-setting of the commands and re-transference of the display data) to cope with catastrophic noise.