



October 2014

CNY171M, CNY172M, CNY173M, CNY174M, CNY17F1M, CNY17F2M, CNY17F3M, CNY17F4M, MOC8106M 6-Pin DIP High BV_{CEO} Phototransistor Optocouplers

Features

- High BV_{CEO} : 70 V Minimum (CNY17XM, CNY17FXM, MOC8106M)
- Closely Matched Current Transfer Ratio (CTR) Minimizes Unit-to-Unit Variation
- Current Transfer Ratio In Select Groups
- Very Low Coupled Capacitance Along With No Chip-to-Pin 6 Base Connection for Minimum Noise Susceptability (CNY17FXM, MOC8106M)
- Safety and Regulatory Approvals:
 - UL1577, 4,170 VAC_{RMS} for 1 Minute
 - DIN-EN/IEC60747-5-5, 850 V Peak Working Insulation Voltage

Applications

- Power Supply Regulators
- Digital Logic Inputs
- Microprocessor Inputs
- Appliance Sensor Systems
- Industrial Controls

Description

The CNY17XM, CNY17FXM, and MOC8106M devices consist of a gallium arsenide infrared emitting diode coupled with an NPN phototransistor in a dual in-line package.

Package Outlines

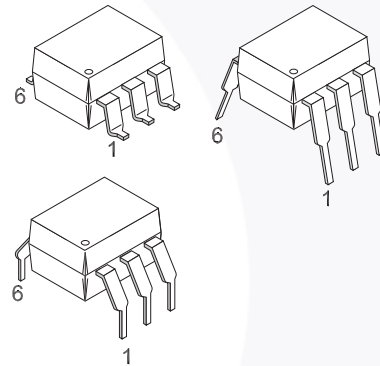

Figure 1. Package Outlines

Schematics

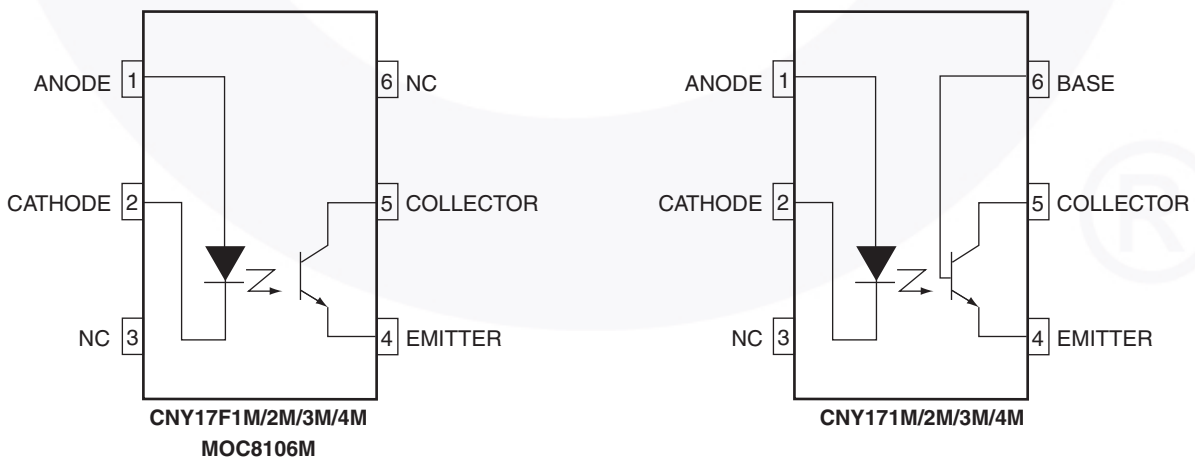

Figure 2. Schematics

CNY17XM, CNY17FXM, MOC8106M — 6-Pin DIP High BV_{CEO} Phototransistor Optocouplers

Safety and Insulation Ratings

As per DIN EN/IEC 60747-5-5, this optocoupler is suitable for “safe electrical insulation” only within the safety limit data. Compliance with the safety ratings shall be ensured by means of protective circuits.

Parameter		Characteristics
Installation Classifications per DIN VDE 0110/1.89 Table 1, For Rated Mains Voltage	< 150 V _{RMS}	I–IV
	< 300 V _{RMS}	I–IV
Climatic Classification		55/100/21
Pollution Degree (DIN VDE 0110/1.89)		2
Comparative Tracking Index		175

Symbol	Parameter	Value	Unit
V _{PR}	Input-to-Output Test Voltage, Method A, V _{IORM} × 1.6 = V _{PR} , Type and Sample Test with t _m = 10 s, Partial Discharge < 5 pC	1360	V _{peak}
	Input-to-Output Test Voltage, Method B, V _{IORM} × 1.875 = V _{PR} , 100% Production Test with t _m = 1 s, Partial Discharge < 5 pC	1594	V _{peak}
V _{IORM}	Maximum Working Insulation Voltage	850	V _{peak}
V _{IOTM}	Highest Allowable Over-Voltage	6000	V _{peak}
	External Creepage	≥ 7	mm
	External Clearance	≥ 7	mm
	External Clearance (for Option TV, 0.4" Lead Spacing)	≥ 10	mm
DTI	Distance Through Insulation (Insulation Thickness)	≥ 0.5	mm
T _S	Case Temperature ⁽¹⁾	175	°C
I _{S,INPUT}	Input Current ⁽¹⁾	350	mA
P _{S,OUTPUT}	Output Power ⁽¹⁾	800	mW
R _{IO}	Insulation Resistance at T _S , V _{IO} = 500 V ⁽¹⁾	> 10 ⁹	Ω

Note:

1. Safety limit values – maximum values allowed in the event of a failure.

Absolute Maximum Ratings

Stresses exceeding the absolute maximum ratings may damage the device. The device may not function or be operable above the recommended operating conditions and stressing the parts to these levels is not recommended. In addition, extended exposure to stresses above the recommended operating conditions may affect device reliability. The absolute maximum ratings are stress ratings only.

Symbol	Parameters	Value	Units
TOTAL DEVICE			
T _{STG}	Storage Temperature	-40 to +125	°C
T _A	Ambient Operating Temperature	-40 to +100	°C
T _J	Junction Temperature	-40 to +125	°C
T _{SOL}	Lead Solder Temperature	260 for 10 seconds	°C
P _D	Total Device Power Dissipation @ 25°C (LED plus detector) Derate Linearly From 25°C	270	mW
		2.94	mW/°C
EMITTER			
I _F	Continuous Forward Current	60	mA
V _R	Reverse Voltage	6	V
I _F (pk)	Forward Current – Peak (1 μs pulse, 300 pps)	1.5	A
P _D	LED Power Dissipation 25°C Ambient Derate Linearly From 25°C	120	mW
		1.41	mW/°C
DETECTOR			
I _C	Continuous Collector Current	50	mA
V _{CEO}	Collector-Emitter Voltage	70	V
V _{ECO}	Emitter Collector Voltage	7	V
P _D	Detector Power Dissipation @ 25°C Derate Linearly from 25°C	150	mW
		1.76	mW/°C

Electrical Characteristics

$T_A = 25^\circ\text{C}$ unless otherwise specified.

Individual Component Characteristics

Symbol	Parameters	Test Conditions	Device	Min.	Typ.	Max.	Units
EMITTER							
V_F	Input Forward Voltage	$I_F = 10\text{ mA}$	All Devices	1.0	1.15	1.50	V
		$I_F = 60\text{ mA}$	CNY17XM, CNY17FXM	1.0	1.35	1.65	v
C_J	Capacitance	$V_F = 0\text{ V}, f = 1.0\text{ MHz}$	All Devices		18		pF
I_R	Reverse Leakage Current	$V_R = 6\text{ V}$	All Devices		0.001	10	μA
DETECTOR							
BV_{CEO}	Breakdown Voltage Collector-to-Emitter	$I_C = 1\text{ mA}, I_F = 0$	All Devices	70	100		V
			CNY17XM	70	120		V
BV_{CBO}	Collector-to-Base	$I_C = 10\text{ }\mu\text{A}, I_F = 0$	CNY17XM	70	120		V
BV_{ECO}	Emitter-to-Collector	$I_E = 100\text{ }\mu\text{A}, I_F = 0$	All Devices	7	10		V
I_{CEO}	Leakage Current Collector-to-Emitter	$V_{CE} = 10\text{ V}, I_F = 0$	All Devices		1	50	nA
			CNY17XM			20	nA
I_{CBO}	Collector-to-Base	$V_{CB} = 10\text{ V}, I_F = 0$	CNY17XM			20	nA
C_{CE}	Capacitance Collector-to-Emitter	$V_{CE} = 0, f = 1\text{ MHz}$	All Devices		8		pF
			CNY17XM		20		pF
			CNY17XM		10		pF
C_{CB}	Collector-to-Base	$V_{CB} = 0, f = 1\text{ MHz}$	CNY17XM		20		pF
C_{EB}	Emitter-to-Base	$V_{EB} = 0, f = 1\text{ MHz}$	CNY17XM		10		pF

Transfer Characteristics

Symbol	Parameters	Test Conditions	Device	Min.	Typ.	Max.	Units
COUPLED							
CTR	Current Transfer Ratio	$I_F = 10\text{ mA}, V_{CE} = 10\text{ V}$	MOC8106M	50		150	%
		$I_F = 10\text{ mA}, V_{CE} = 5\text{ V}$	CNY171M, CNY17F1M	40		80	%
		$I_F = 10\text{ mA}, V_{CE} = 5\text{ V}$	CNY172M, CNY17F2M	63		125	%
		$I_F = 10\text{ mA}, V_{CE} = 5\text{ V}$	CNY173M, CNY17F3M	100		200	%
		$I_F = 10\text{ mA}, V_{CE} = 5\text{ V}$	CNY174M, CNY17F4M	160		320	%
$V_{CE(SAT)}$	Collector-Emitter Saturation Voltage	$I_C = 0.5\text{ mA}, I_F = 5\text{ mA}$	MOC8106M			0.4	V
		$I_C = 2.5\text{ mA}, I_F = 10\text{ mA}$	CNY17XM/CNY17FXM			0.4	V

Electrical Characteristics (Continued)

T_A = 25°C unless otherwise specified.

AC Characteristics

Symbol	Parameters	Test Conditions	Device	Min.	Typ.	Max.	Units
NON-SATURATED SWITCHING TIME							
t _{on}	Turn-On Time	I _C = 2.0 mA, V _{CC} = 10 V, R _L = 100 Ω	All Devices		2.0	10.0	μs
t _{off}	Turn-Off Time	I _C = 2.0 mA, V _{CC} = 10 V, R _L = 100 Ω	All Devices		3.0	10.0	μs
t _d	Delay Time	I _F = 10 mA, V _{CC} = 5 V, R _L = 75 Ω	CNY17XM/CNY17FXM			5.6	μs
t _r	Rise Time	I _F = 10 mA, V _{CC} = 5 V, R _L = 75 Ω	CNY17XM/CNY17FXM			4.0	μs
t _s	Storage Time	I _F = 10 mA, V _{CC} = 5 V, R _L = 75 Ω	CNY17XM/CNY17FXM			4.1	μs
t _f	Fall Time	I _F = 10 mA, V _{CC} = 5 V, R _L = 75 Ω	CNY17XM/CNY17FXM			3.5	μs
SATURATED SWITCHING TIMES							
t _d	Delay Time	I _F = 20 mA, V _{CC} = 5 V, R _L = 1 kΩ	CNY171M/F1M			5.5	μs
		I _F = 10 mA, V _{CC} = 5 V, R _L = 1 kΩ	CNY172M/3M/4M CNY17F2M/F3M/F4M			8.0	μs
t _r	Rise Time	I _F = 20 mA, V _{CC} = 5 V, R _L = 1 kΩ	CNY171M/F1M			4.0	μs
		I _F = 10 mA, V _{CC} = 5 V, R _L = 1 kΩ	CNY172M/3M/4M CNY17F2M/F3M/F4M			6.0	μs
t _s	Storage Time	I _F = 20 mA, V _{CC} = 5 V, R _L = 1 kΩ	CNY171M/F1M			34.0	μs
		I _F = 10 mA, V _{CC} = 5 V, R _L = 1 kΩ	CNY172M/3M/4M CNY17F2M/F3M/F4M			39.0	μs
t _f	Fall Time	I _F = 20 mA, V _{CC} = 5 V, R _L = 1 kΩ	CNY171M/F1M			20.0	μs
		I _F = 10 mA, V _{CC} = 5 V, R _L = 1 kΩ	CNY172M/3M/4M CNY17F2M/F3M/F4M			24.0	μs

Isolation Characteristics

Symbol	Characteristic	Test Conditions	Min.	Typ.	Max.	Units
V _{ISO}	Input-Output Isolation Voltage	t = 1 Minute	4170			V _{AC} _{RMS}
C _{ISO}	Isolation Capacitance	V _{I-O} = 0 V, f = 1 MHz		0.2		pF
R _{ISO}	Isolation Resistance	V _{I-O} = ±500 VDC, T _A = 25°C	10 ¹¹			Ω

Typical Performance Characteristics

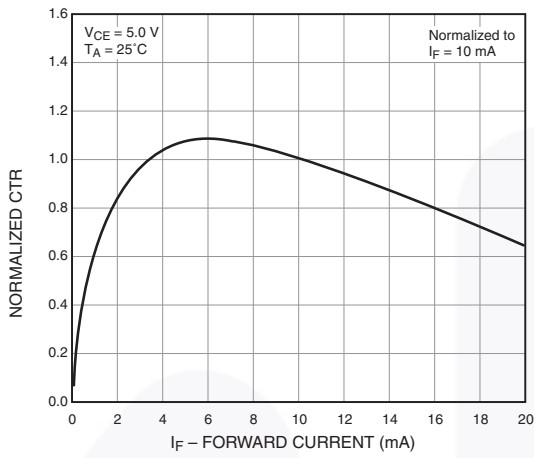

Figure 3. Normalized CTR vs. Forward Current

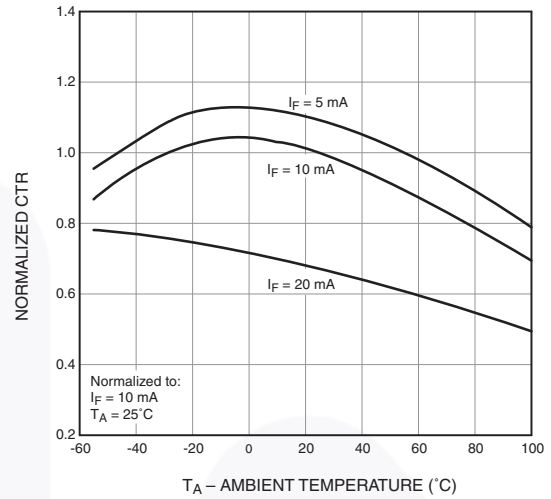

Figure 4. Normalized CTR vs. Ambient Temperature

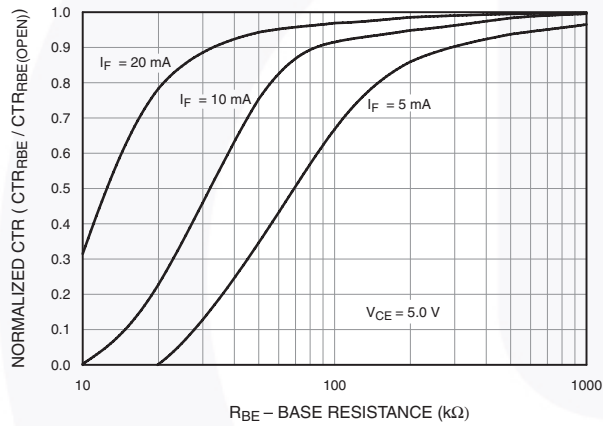

Figure 5. CTR vs. R_{BE} (Unsaturated)

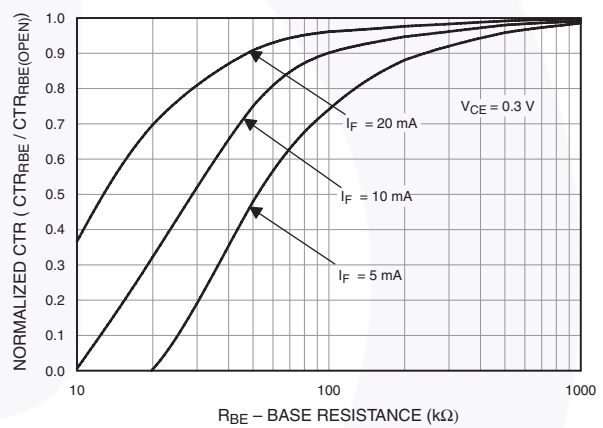

Figure 6. CTR vs. R_{BE} (Saturated)

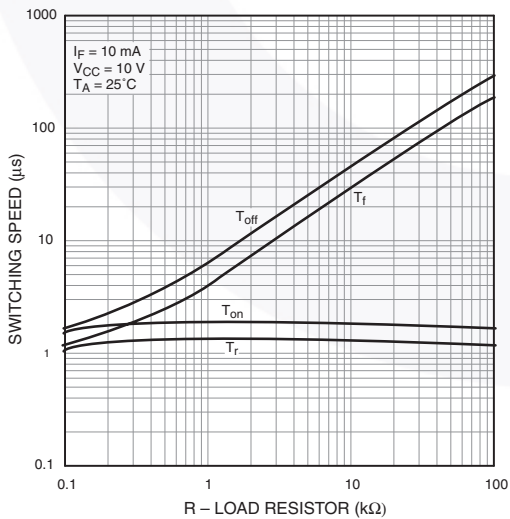

Figure 7. Switching Speed vs. Load Resistor

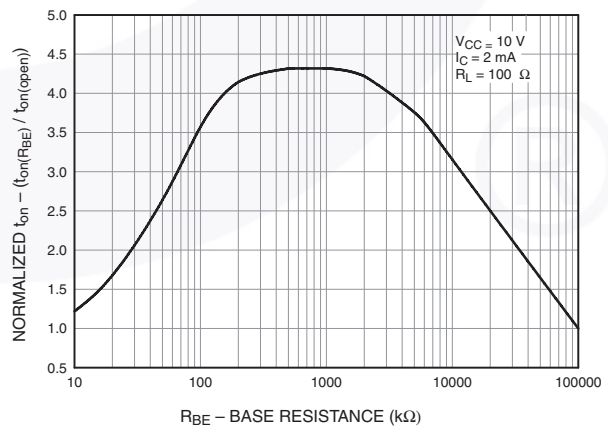

Figure 8. Normalized t_{on} vs. R_{BE}

Typical Performance Characteristics (Continued)

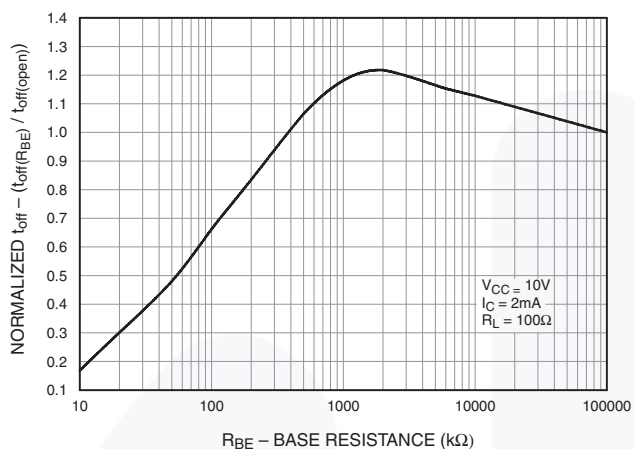

Figure 9. Normalized t_{off} vs. R_{BE}

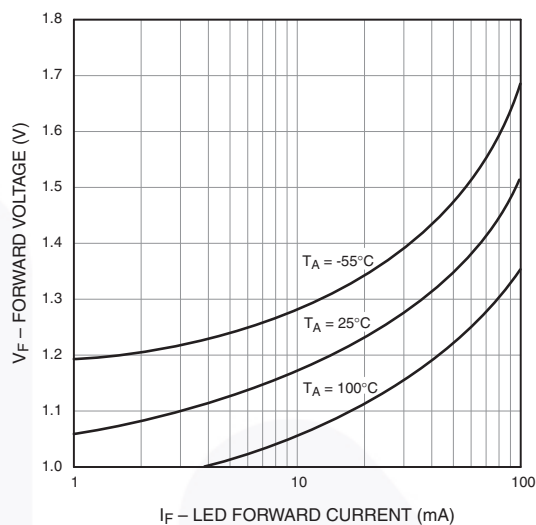

Figure 10. LED Forward Voltage vs. Forward Current

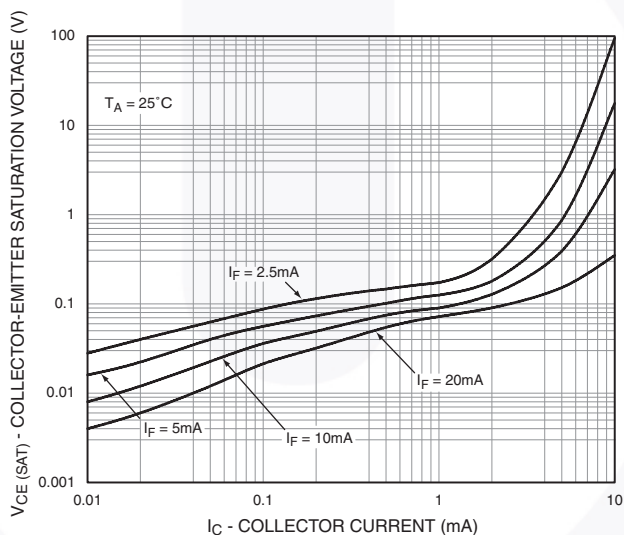

Figure 11. Collector-Emitter Saturation Voltage vs. Collector Current

Switching Test Circuit and Waveforms

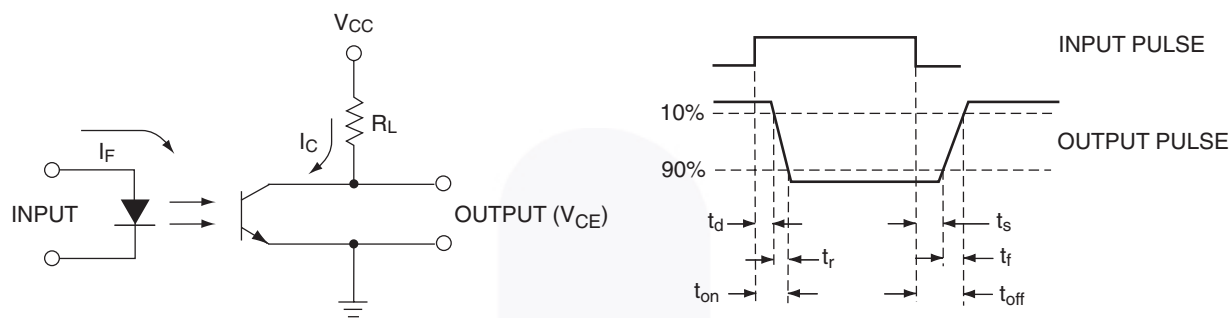

Figure 12. Switching Test Circuit and Waveforms

Reflow Profile

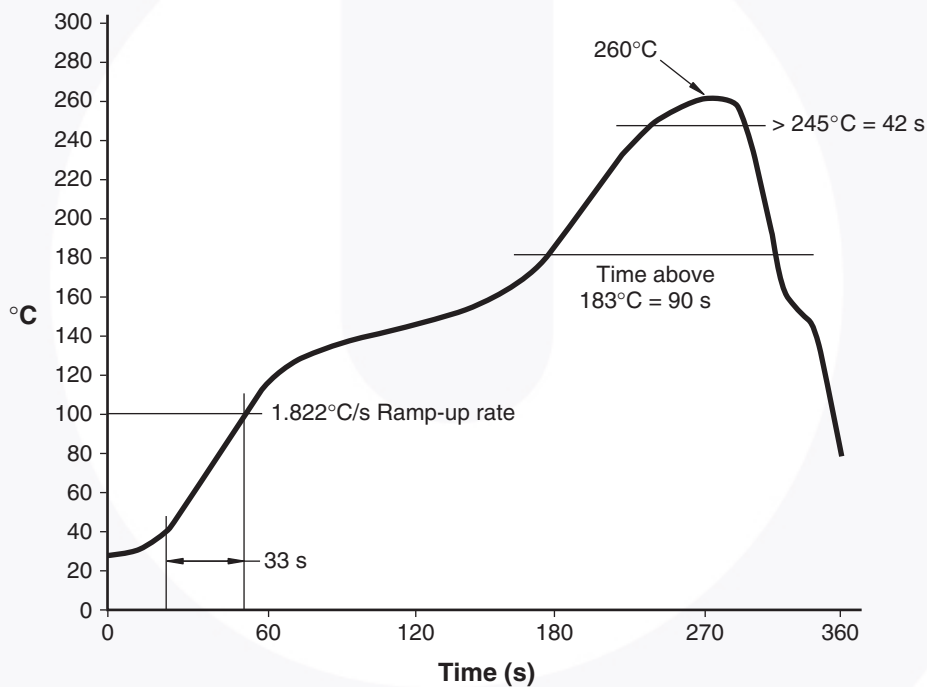

Figure 13. Reflow Profile

Ordering Information

Part Number	Package	Packing Method
CNY171M	DIP 6-Pin	Tube (50 Units)
CNY171SM	SMT 6-Pin (Lead Bend)	Tube (50 Units)
CNY171SR2M	SMT 6-Pin (Lead Bend)	Tape and Reel (1000 Units)
CNY171TM	DIP 6-Pin, 0.4" Lead Spacing	Tube (50 Units)
CNY171VM	DIP 6-Pin, DIN EN/IEC60747-5-5 Option	Tube (50 Units)
CNY171SVM	SMT 6-Pin (Lead Bend), DIN EN/IEC60747-5-5 Option	Tube (50 Units)
CNY171SR2VM	SMT 6-Pin (Lead Bend), DIN EN/IEC60747-5-5 Option	Tape and Reel (1000 Units)
CNY171TVM	DIP 6-Pin, 0.4" Lead Spacing, DIN EN/IEC60747-5-5 Option	Tube (50 Units)

Note:

2. The product orderable part number system listed in this table also applies to the CNY17FXM product family and the MOC8106M device.

Marking Information

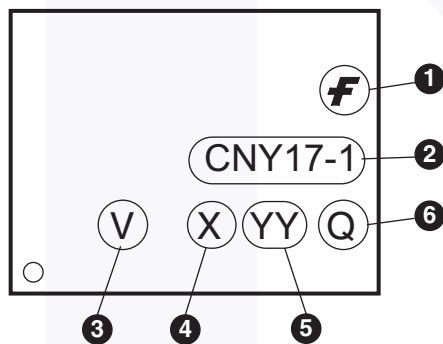
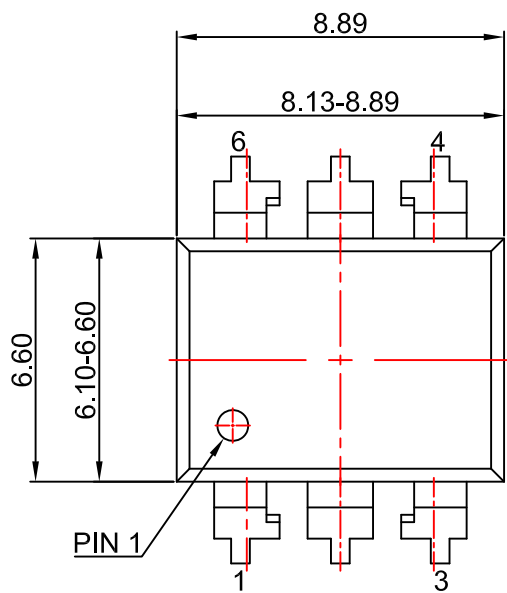

Figure 14. Top Mark

Table 1. Top Mark Definitions

1	Fairchild Logo
2	Device Number
3	DIN EN/IEC60747-5-5 Option (only appears on component ordered with this option)
4	One-Digit Year Code, e.g., "4"
5	Digit Work Week, Ranging from "01" to "53"
6	Assembly Package Code



NOTES:

- A) NO STANDARD APPLIES TO THIS PACKAGE.
- B) ALL DIMENSIONS ARE IN MILLIMETERS.
- C) DIMENSIONS ARE EXCLUSIVE OF BURRS, MOLD FLASH, AND TIE BAR EXTRUSION
- D) DRAWING FILENAME AND REVISION: MKT-N06BREV4.





LAND PATTERN RECOMMENDATION



NOTES:

- A) NO STANDARD APPLIES TO THIS PACKAGE.
- B) ALL DIMENSIONS ARE IN MILLIMETERS.
- C) DIMENSIONS ARE EXCLUSIVE OF BURRS, MOLD FLASH, AND TIE BAR EXTRUSION
- D) DRAWING FILENAME AND REVISION : MKT-N06CREV4.



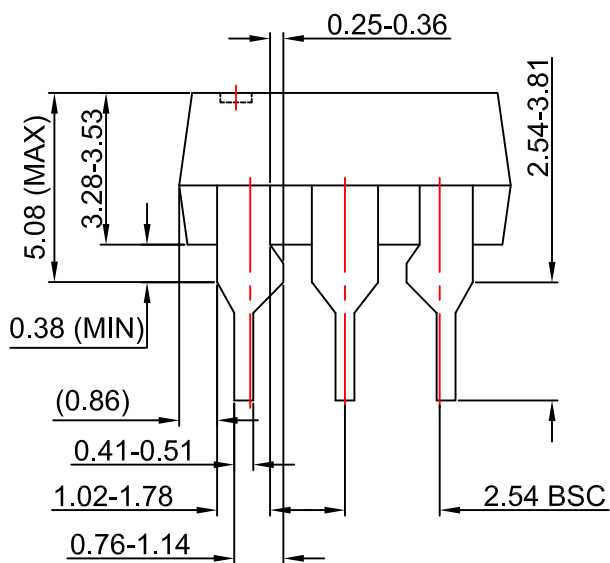

NOTES:

- A) NO STANDARD APPLIES TO THIS PACKAGE.
- B) ALL DIMENSIONS ARE IN MILLIMETERS.
- C) DIMENSIONS ARE EXCLUSIVE OF BURRS, MOLD FLASH, AND TIE BAR EXTRUSION
- D) DRAWING FILENAME AND REVISION: MKT-N06Drev4





TRADEMARKS

The following includes registered and unregistered trademarks and service marks, owned by Fairchild Semiconductor and/or its global subsidiaries, and is not intended to be an exhaustive list of all such trademarks.

- | | | | |
|--------------------------|--|---------------------------------------|------------------|
| AccuPower™ | F-PFS™ | OPTOPLANAR® | SYSTEM GENERAL® |
| AttitudeEngine™ | FRFET® | Power Supply WebDesigner™ | TinyBoost® |
| Awinda® | Global Power Resource SM | PowerTrench® | TinyBuck® |
| AX-CAP®* | GreenBridge™ | PowerXS™ | TinyCalc™ |
| BitSiC™ | Green FPS™ | Programmable Active Droop™ | TinyLogic® |
| Build it Now™ | Green FPS™ e-Series™ | QFET® | TINYOPTO™ |
| CorePLUS™ | Gmax™ | QS™ | TinyPower™ |
| CorePOWER™ | GTO™ | Quiet Series™ | TinyPWM™ |
| CROSSVOL™ | IntelliMAX™ | RapidConfigure™ | TinyWire™ |
| CTL™ | ISOPLANAR™ | Saving our world, 1mW/W/kW at a time™ | TranSiC™ |
| Current Transfer Logic™ | Making Small Speakers Sound Louder and Better™ | SignalWise™ | TriFault Detect™ |
| DEUXPEED® | MegaBuck™ | SmartMax™ | TRUECURRENT®* |
| Dual Cool™ | MICROCOUPLER™ | SMART START™ | μSerDes™ |
| EcoSPARK® | MicroFET™ | Solutions for Your Success™ | UHC® |
| EfficientMax™ | MicroPak™ | SPM® | Ultra FRFET™ |
| ESBC™ | MicroPak2™ | STEALTH™ | UniFET™ |
| F [®] | MillerDrive™ | SuperFET® | VCX™ |
| Fairchild® | MotionMax™ | SuperSOT™-3 | VisualMax™ |
| Fairchild Semiconductor® | MotionGrid® | SuperSOT™-6 | VoltagePlus™ |
| FACT Quiet Series™ | MTi® | SuperSOT™-8 | XST™ |
| FACT® | MTx® | SupreMOS® | Xsens™ |
| FastvCore™ | MVN® | SyncFET™ | 仙童® |
| FETBench™ | mWSaver® | Sync-Lock™ | |
| FPS™ | OptoHiT™ | | |
| | OPTOLOGIC® | | |

* Trademarks of System General Corporation, used under license by Fairchild Semiconductor.

DISCLAIMER

FAIRCHILD SEMICONDUCTOR RESERVES THE RIGHT TO MAKE CHANGES WITHOUT FURTHER NOTICE TO ANY PRODUCTS HEREIN TO IMPROVE RELIABILITY, FUNCTION, OR DESIGN. TO OBTAIN THE LATEST, MOST UP-TO-DATE DATASHEET AND PRODUCT INFORMATION, VISIT OUR WEBSITE AT [HTTP://WWW.FAIRCHILDSEMI.COM](http://www.fairchildsemi.com). FAIRCHILD DOES NOT ASSUME ANY LIABILITY ARISING OUT OF THE APPLICATION OR USE OF ANY PRODUCT OR CIRCUIT DESCRIBED HEREIN; NEITHER DOES IT CONVEY ANY LICENSE UNDER ITS PATENT RIGHTS, NOR THE RIGHTS OF OTHERS. THESE SPECIFICATIONS DO NOT EXPAND THE TERMS OF FAIRCHILD'S WORLDWIDE TERMS AND CONDITIONS, SPECIFICALLY THE WARRANTY THEREIN, WHICH COVERS THESE PRODUCTS.

AUTHORIZED USE

Unless otherwise specified in this data sheet, this product is a standard commercial product and is not intended for use in applications that require extraordinary levels of quality and reliability. This product may not be used in the following applications, unless specifically approved in writing by a Fairchild officer: (1) automotive or other transportation, (2) military/aerospace, (3) any safety critical application – including life critical medical equipment – where the failure of the Fairchild product reasonably would be expected to result in personal injury, death or property damage. Customer's use of this product is subject to agreement of this Authorized Use policy. In the event of an unauthorized use of Fairchild's product, Fairchild accepts no liability in the event of product failure. In other respects, this product shall be subject to Fairchild's Worldwide Terms and Conditions of Sale, unless a separate agreement has been signed by both Parties.

ANTI-COUNTERFEITING POLICY

Fairchild Semiconductor Corporation's Anti-Counterfeiting Policy. Fairchild's Anti-Counterfeiting Policy is also stated on our external website, www.fairchildsemi.com, under Terms of Use

Counterfeiting of semiconductor parts is a growing problem in the industry. All manufacturers of semiconductor products are experiencing counterfeiting of their parts. Customers who inadvertently purchase counterfeit parts experience many problems such as loss of brand reputation, substandard performance, failed applications, and increased cost of production and manufacturing delays. Fairchild is taking strong measures to protect ourselves and our customers from the proliferation of counterfeit parts. Fairchild strongly encourages customers to purchase Fairchild parts either directly from Fairchild or from Authorized Fairchild Distributors who are listed by country on our web page cited above. Products customers buy either from Fairchild directly or from Authorized Fairchild Distributors are genuine parts, have full traceability, meet Fairchild's quality standards for handling and storage and provide access to Fairchild's full range of up-to-date technical and product information. Fairchild and our Authorized Distributors will stand behind all warranties and will appropriately address any warranty issues that may arise. Fairchild will not provide any warranty coverage or other assistance for parts bought from Unauthorized Sources. Fairchild is committed to combat this global problem and encourage our customers to do their part in stopping this practice by buying direct or from authorized distributors.

PRODUCT STATUS DEFINITIONS

Definition of Terms

Datasheet Identification	Product Status	Definition
Advance Information	Formative / In Design	Datasheet contains the design specifications for product development. Specifications may change in any manner without notice.
Preliminary	First Production	Datasheet contains preliminary data; supplementary data will be published at a later date. Fairchild Semiconductor reserves the right to make changes at any time without notice to improve design.
No Identification Needed	Full Production	Datasheet contains final specifications. Fairchild Semiconductor reserves the right to make changes at any time without notice to improve the design.
Obsolete	Not In Production	Datasheet contains specifications on a product that is discontinued by Fairchild Semiconductor. The datasheet is for reference information only.

Rev. I77