

PLEASE CHECK WWW.MOLEX.COM FOR LATEST PART INFORMATION

Part Number: [0003062011](#)
Status: **Active**
Overview: Standard .062" Pin and Socket Power Connectors
Description: 1.57mm Diameter Standard .062" Pin and Socket Plug Housing, 1 Circuits

Documents:

[3D Model](#) [Packaging Specification PK-1625-003 \(PDF\)](#)
[Drawing \(PDF\)](#) [RoHS Certificate of Compliance \(PDF\)](#)
[Product Specification PS-02-06 \(PDF\)](#)

Agency Certification

CSA LR19980
 UL E29179

General

Product Family Crimp Housings
 Series [1625](#)
 Application Power, Wire-to-Wire
 Comments Polarized to Mating Part
 MolexKits Yes
 Overview [Standard .062" Pin and Socket Power Connectors](#)
 Product Name Standard .062"
 UPC 800753746152

Physical

Breakaway No
 Circuits (maximum) 1
 Circuits Detail 1
 Color - Resin Natural
 Flammability 94V-2
 Gender Plug
 Glow-Wire Compliant No
 Keying to Mating Part None
 Lock to Mating Part Yes
 Material - Resin Nylon
 Net Weight 0.357/g
 Number of Rows 1
 Packaging Type Bag
 Panel Mount No
 Pitch - Mating Interface N/A
 Pitch - Termination Interface N/A
 Polarized to Mating Part Yes
 Stackable No
 Temperature Range - Operating -40°C to +105°C

Electrical

Current - Maximum per Contact 5.0A

Solder Process Data

Lead-freeProcess Capability N/A

Material Info

Old Part Number 1625-1P

Reference - Drawing Numbers

Packaging Specification PK-1625-003
 Product Specification PS-02-06
 Sales Drawing SD-1625-1*-*

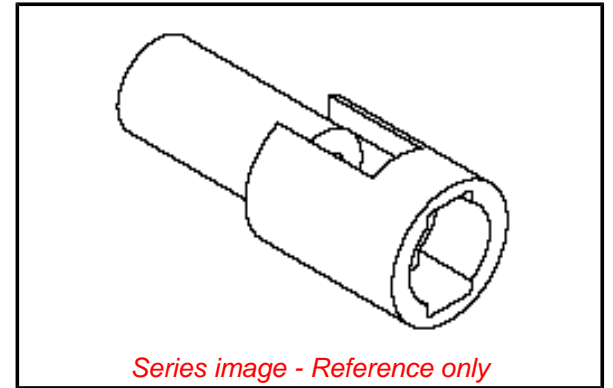

EU ELV

Not Relevant

EU RoHS

Compliant

REACH SVHC

Not Contained Per
 -ED/79/2015 (17
 December 2015)

Halogen-Free

Status

Low-Halogen

**Need more information on product
 environmental compliance?**

Email productcompliance@molex.com
 Please visit the [Contact Us](#) section for any
 non-product compliance questions.

China ROHS

ELV

Green Image

Not Relevant

Search Parts in this Series

[1625](#) Series

Mates With

03-06-1011

Use With

Female Crimp Terminals [1561](#) , [4559](#) , [4529](#)
 , [2190](#) , [2189](#) , [1787](#) , [1855](#) . Male Crimp
 Terminals [1560](#) , [1786](#) , [1854](#) . [1778](#) Male
 PC Tail Terminals. [1779](#) Female PC Tail
 Terminals

This document was generated on 03/30/2016

PLEASE CHECK WWW.MOLEX.COM FOR LATEST PART INFORMATION