

**PLEASE CHECK WWW.MOLEX.COM FOR LATEST PART INFORMATION**

**Part Number:** [0039012021](#)  
**Status:** **Active**  
**Overview:** [Mini-Fit Jr.™ Power Connectors](#)  
**Description:** Mini-Fit Jr.™ Plug Housing, Dual Row, 2 Circuits, UL 94V-2, Natural

**Documents:**

<a href="#">3D Model</a>	<a href="#">Product Specification PS-5556-001 (PDF)</a>
<a href="#">Drawing (PDF)</a>	<a href="#">Packaging Specification PK-5559-001 (PDF)</a>
<a href="#">Product Specification PS-45750-001 (PDF)</a>	<a href="#">RoHS Certificate of Compliance (PDF)</a>

**Agency Certification**

CSA	LR19980
UL	E29179

**General**

Product Family	Crimp Housings
Series	5559
Application	Power, Wire-to-Board, Wire-to-Wire
Comments	Current = 13A max. per circuit when header is mated to a receptacle loaded with <a href="#">45750</a> series terminals crimped to 16 AWG wire. . See Molex product specification PS-45750-001 for additional current derating information.. Glow Wire Equivalent Part.
MolexKits	Yes
Overview	<a href="#">Mini-Fit Jr.™ Power Connectors</a>
Product Name	Mini-Fit Jr.™
UPC	800753584266

**Physical**

Breakaway	No
Circuits (maximum)	2
Color - Resin	Natural
Flammability	94V-2
Gender	Plug
Glow-Wire Compliant	No
Material - Resin	Nylon
Net Weight	1.237/g
Number of Rows	2
Packaging Type	Bag
Panel Mount	Yes
Pitch - Mating Interface	4.20mm
Pitch - Termination Interface	4.20mm
Polarized to Mating Part	Yes
Stackable	No
Temperature Range - Operating	-40°C to +105°C

**Electrical**

Current - Maximum per Contact	13.0A
-------------------------------	-------

**Material Info**

Old Part Number	5559-02P
-----------------	----------

**Reference - Drawing Numbers**

Packaging Specification	PK-5559-001
Product Specification	PS-45750-001, PS-5556-001
Sales Drawing	SD-5559-NP

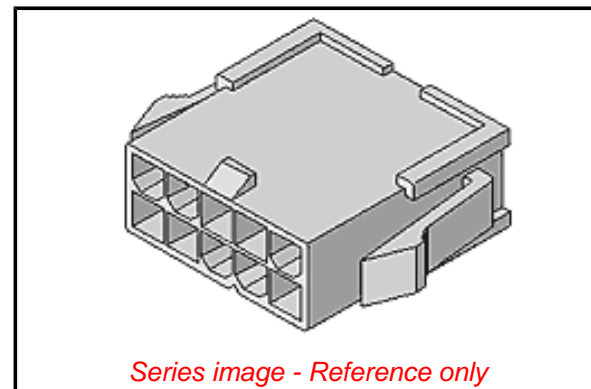

**EU ELV**

**Not Relevant**

**EU RoHS**

**Compliant**

**REACH SVHC**

Not Contained Per -ED/79/2015 (17 December 2015)

**Halogen-Free**

**Status**

**Low-Halogen**

**Need more information on product environmental compliance?**

Email [productcompliance@molex.com](mailto:productcompliance@molex.com)  
Please visit the [Contact Us](#) section for any non-product compliance questions.

China ROHS

ELV

Green Image

Not Relevant

**Search Parts in this Series**

[5559](#) Series

**Mates With**

[5557](#) Dual Row Receptacle Housing

**Use With**

[5558](#) , [30490](#) Male Terminal

This document was generated on 06/02/2016

**PLEASE CHECK [WWW.MOLEX.COM](http://WWW.MOLEX.COM) FOR LATEST PART INFORMATION**