



# Precision Instrumentation Amplifier

## AD8221

### FEATURES

#### Easy to use

Available in space-saving MSOP

Gain set with 1 external resistor (gain range 1 to 1000)

Wide power supply range:  $\pm 2.3$  V to  $\pm 18$  V

Temperature range for specified performance:

$-40^{\circ}\text{C}$  to  $+85^{\circ}\text{C}$

Operational up to  $125^{\circ}\text{C}$ <sup>1</sup>

#### Excellent AC specifications

80 dB minimum CMRR to 10 kHz ( $G = 1$ )

825 kHz,  $-3$  dB bandwidth ( $G = 1$ )

2 V/ $\mu\text{s}$  slew rate

#### Low noise

8 nV/ $\sqrt{\text{Hz}}$ , @ 1 kHz, maximum input voltage noise

0.25  $\mu\text{V}$  p-p input noise (0.1 Hz to 10 Hz)

#### High accuracy dc performance (AD8221BR)

90 dB minimum CMRR ( $G = 1$ )

25  $\mu\text{V}$  maximum input offset voltage

0.3  $\mu\text{V}/^{\circ}\text{C}$  maximum input offset drift

0.4 nA maximum input bias current

### APPLICATIONS

Weigh scales

Industrial process controls

Bridge amplifiers

Precision data acquisition systems

Medical instrumentation

Strain gages

Transducer interfaces

### GENERAL DESCRIPTION

The AD8221 is a gain programmable, high performance instrumentation amplifier that delivers the industry's highest CMRR over frequency in its class. The CMRR of instrumentation amplifiers on the market today falls off at 200 Hz. In contrast, the AD8221 maintains a minimum CMRR of 80 dB to 10 kHz for all grades at  $G = 1$ . High CMRR over frequency allows the AD8221 to reject wideband interference and line harmonics, greatly simplifying filter requirements. Possible applications include precision data acquisition, biomedical analysis, and aerospace instrumentation.

### CONNECTION DIAGRAM

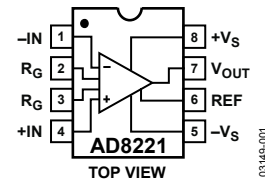

Figure 1.

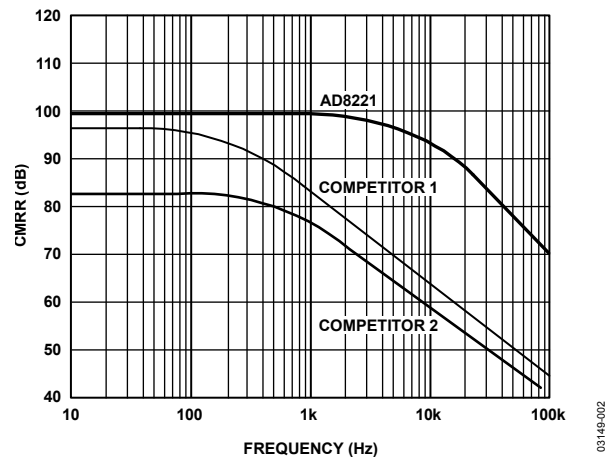

Figure 2. Typical CMRR vs. Frequency for  $G = 1$

Low voltage offset, low offset drift, low gain drift, high gain accuracy, and high CMRR make this part an excellent choice in applications that demand the best dc performance possible, such as bridge signal conditioning.

Programmable gain affords the user design flexibility. A single resistor sets the gain from 1 to 1000. The AD8221 operates on both single and dual supplies and is well suited for applications where  $\pm 10$  V input voltages are encountered.

The AD8221 is available in a low cost 8-lead SOIC and 8-lead MSOP, both of which offer the industry's best performance. The MSOP requires half the board space of the SOIC, making it ideal for multichannel or space-constrained applications.

Performance is specified over the entire industrial temperature range of  $-40^{\circ}\text{C}$  to  $+85^{\circ}\text{C}$  for all grades. Furthermore, the AD8221 is operational from  $-40^{\circ}\text{C}$  to  $+125^{\circ}\text{C}$ <sup>1</sup>.

<sup>1</sup> See Typical Performance Characteristics for expected operation from  $85^{\circ}\text{C}$  to  $125^{\circ}\text{C}$ .

#### Rev. C

Information furnished by Analog Devices is believed to be accurate and reliable. However, no responsibility is assumed by Analog Devices for its use, nor for any infringements of patents or other rights of third parties that may result from its use. Specifications subject to change without notice. No license is granted by implication or otherwise under any patent or patent rights of Analog Devices. Trademarks and registered trademarks are the property of their respective owners.

# AD8221

## TABLE OF CONTENTS

Features .....	1	Layout .....	18
Applications.....	1	Reference Terminal .....	19
General Description .....	1	Power Supply Regulation and Bypassing .....	19
Connection Diagram .....	1	Input Bias Current Return Path .....	19
Revision History .....	2	Input Protection .....	19
Specifications.....	3	RF Interference .....	20
Absolute Maximum Ratings.....	8	Precision Strain Gage.....	20
Thermal Characteristics .....	8	Conditioning $\pm 10$ V Signals for a +5 V Differential Input	
ESD Caution.....	8	ADC .....	20
Pin Configuration and Function Descriptions.....	9	AC-Coupled Instrumentation Amplifier .....	21
Typical Performance Characteristics .....	10	Die Information.....	22
Theory of Operation .....	17	Outline Dimensions .....	23
Gain Selection .....	18	Ordering Guide .....	24

## REVISION HISTORY

### 3/11—Rev. B to Rev. C

Added Pin Configuration and Function Descriptions Section ..	9
Added Die Information Section .....	22
Updated Outline Dimensions .....	23
Changes to Ordering Guide .....	24

### 9/07—Rev. A to Rev. B

Changes to Features.....	1
Changes to Table 1 Layout.....	3
Changes to Table 2 Layout.....	5
Changes to Figure 15.....	11
Changes to Figures 32 .....	13
Changes to Figure 33, Figure 34, and Figure 35 .....	14
Updated Outline Dimensions .....	21
Changes to Ordering Guide .....	22

### 11/03—Rev. 0 to Rev. A

Changes to Features.....	1
Changes to Specifications Section .....	4
Changes to Theory of Operation Section.....	13
Changes to Gain Selection Section.....	14

### 10/03—Revision 0: Initial Version

## SPECIFICATIONS

$V_S = \pm 15\text{ V}$ ,  $V_{REF} = 0\text{ V}$ ,  $T_A = 25^\circ\text{C}$ ,  $G = 1$ ,  $R_L = 2\text{ k}\Omega$ , unless otherwise noted.

**Table 1.**

Parameter	Conditions	AR Grade			BR Grade			Unit	
		Min	Typ	Max	Min	Typ	Max		
COMMON-MODE REJECTION RATIO									
CMRR DC to 60 Hz with 1 k $\Omega$ Source Imbalance	$V_{CM} = -10\text{ V to }+10\text{ V}$								
G = 1		80			90			dB	
G = 10		100			110			dB	
G = 100		120			130			dB	
G = 1000		130			140			dB	
CMRR at 10 kHz	$V_{CM} = -10\text{ V to }+10\text{ V}$								
G = 1		80			80			dB	
G = 10		90			100			dB	
G = 100		100			110			dB	
G = 1000		100			110			dB	
NOISE	RTI noise = $\sqrt{e_{NI}^2 + (e_{NO}/G)^2}$								
Voltage Noise, 1 kHz									
Input Voltage Noise, $e_{NI}$	$V_{IN+}, V_{IN-}, V_{REF} = 0$			8			8	nV/ $\sqrt{\text{Hz}}$	
Output Voltage Noise, $e_{NO}$				75			75	nV/ $\sqrt{\text{Hz}}$	
RTI	$f = 0.1\text{ Hz to }10\text{ Hz}$								
G = 1				2			2	$\mu\text{V p-p}$	
G = 10				0.5			0.5	$\mu\text{V p-p}$	
G = 100 to 1000				0.25			0.25	$\mu\text{V p-p}$	
Current Noise	$f = 1\text{ kHz}$			40			40	fA/ $\sqrt{\text{Hz}}$	
	$f = 0.1\text{ Hz to }10\text{ Hz}$			6			6	pA p-p	
VOLTAGE OFFSET <sup>1</sup>									
Input Offset, $V_{OSI}$	$V_S = \pm 5\text{ V to } \pm 15\text{ V}$			60			25	$\mu\text{V}$	
Over Temperature	$T = -40^\circ\text{C to }+85^\circ\text{C}$			86			45	$\mu\text{V}$	
Average TC				0.4			0.3	$\mu\text{V}/^\circ\text{C}$	
Output Offset, $V_{OSO}$	$V_S = \pm 5\text{ V to } \pm 15\text{ V}$			300			200	$\mu\text{V}$	
Over Temperature	$T = -40^\circ\text{C to }+85^\circ\text{C}$			0.66			0.45	mV	
Average TC				6			5	$\mu\text{V}/^\circ\text{C}$	
Offset RTI vs. Supply (PSR)	$V_S = \pm 2.3\text{ V to } \pm 18\text{ V}$								
G = 1		90	110		94	110		dB	
G = 10		110	120		114	130		dB	
G = 100		124	130		130	140		dB	
G = 1000		130	140		140	150		dB	
INPUT CURRENT									
Input Bias Current				0.5	1.5		0.2	0.4	nA
Over Temperature	$T = -40^\circ\text{C to }+85^\circ\text{C}$				2.0			1	nA
Average TC				1			1	pA/ $^\circ\text{C}$	
Input Offset Current				0.2	0.6		0.1	0.4	nA
Over Temperature	$T = -40^\circ\text{C to }+85^\circ\text{C}$				0.8			0.6	nA
Average TC				1			1	pA/ $^\circ\text{C}$	
REFERENCE INPUT									
$R_{IN}$				20			20	k $\Omega$	
$I_{IN}$	$V_{IN+}, V_{IN-}, V_{REF} = 0$			50	60		50	60	$\mu\text{A}$
Voltage Range		$-V_S$			$+V_S$		$-V_S$	$+V_S$	V
Gain to Output				$1 \pm 0.0001$			$1 \pm 0.0001$		V/V

# AD8221

Parameter	Conditions	AR Grade			BR Grade			Unit
		Min	Typ	Max	Min	Typ	Max	
<b>POWER SUPPLY</b>								
Operating Range	$V_S = \pm 2.3\text{ V to } \pm 18\text{ V}$	$\pm 2.3$		$\pm 18$	$\pm 2.3$		$\pm 18$	V
Quiescent Current			0.9	1		0.9	1	mA
Over Temperature	$T = -40^\circ\text{C to } +85^\circ\text{C}$		1	1.2		1	1.2	mA
<b>DYNAMIC RESPONSE</b>								
Small Signal –3 dB Bandwidth								
G = 1			825			825		kHz
G = 10			562			562		kHz
G = 100			100			100		kHz
G = 1000			14.7			14.7		kHz
Settling Time 0.01%	10 V step							
G = 1 to 100			10			10		$\mu\text{s}$
G = 1000			80			80		$\mu\text{s}$
Settling Time 0.001%	10 V step							
G = 1 to 100			13			13		$\mu\text{s}$
G = 1000			110			110		$\mu\text{s}$
Slew Rate	G = 1	1.5	2		1.5	2		V/ $\mu\text{s}$
	G = 5 to 100	2	2.5		2	2.5		V/ $\mu\text{s}$
<b>GAIN</b>								
Gain Range	$G = 1 + (49.4\text{ k}\Omega/R_G)$	1		1000	1		1000	V/V
Gain Error	$V_{OUT} \pm 10\text{ V}$							
G = 1				0.03			0.02	%
G = 10				0.3			0.15	%
G = 100				0.3			0.15	%
G = 1000				0.3			0.15	%
Gain Nonlinearity	$V_{OUT} = -10\text{ V to } +10\text{ V}$							
G = 1 to 10	$R_L = 10\text{ k}\Omega$		3	10		3	10	ppm
G = 100	$R_L = 10\text{ k}\Omega$		5	15		5	15	ppm
G = 1000	$R_L = 10\text{ k}\Omega$		10	40		10	40	ppm
G = 1 to 100	$R_L = 2\text{ k}\Omega$		10	95		10	95	ppm
Gain vs. Temperature								
G = 1			3	10		2	5	ppm/ $^\circ\text{C}$
G > 1 <sup>2</sup>				-50			-50	ppm/ $^\circ\text{C}$
<b>INPUT</b>								
Input Impedance								
Differential			100  2			100  2		$G\Omega  \text{pF}$
Common Mode			100  2			100  2		$G\Omega  \text{pF}$
Input Operating Voltage Range <sup>3</sup>	$V_S = \pm 2.3\text{ V to } \pm 5\text{ V}$	$-V_S + 1.9$		$+V_S - 1.1$	$-V_S + 1.9$		$+V_S - 1.1$	V
Over Temperature	$T = -40^\circ\text{C to } +85^\circ\text{C}$	$-V_S + 2.0$		$+V_S - 1.2$	$-V_S + 2.0$		$+V_S - 1.2$	V
Input Operating Voltage Range	$V_S = \pm 5\text{ V to } \pm 18\text{ V}$	$-V_S + 1.9$		$+V_S - 1.2$	$-V_S + 1.9$		$+V_S - 1.2$	V
Over Temperature	$T = -40^\circ\text{C to } +85^\circ\text{C}$	$-V_S + 2.0$		$+V_S - 1.2$	$-V_S + 2.0$		$+V_S - 1.2$	V
<b>OUTPUT</b>								
Output Swing	$R_L = 10\text{ k}\Omega$							
Over Temperature	$V_S = \pm 2.3\text{ V to } \pm 5\text{ V}$	$-V_S + 1.1$		$+V_S - 1.2$	$-V_S + 1.1$		$+V_S - 1.2$	V
	$T = -40^\circ\text{C to } +85^\circ\text{C}$	$-V_S + 1.4$		$+V_S - 1.3$	$-V_S + 1.4$		$+V_S - 1.3$	V
Output Swing	$V_S = \pm 5\text{ V to } \pm 18\text{ V}$	$-V_S + 1.2$		$+V_S - 1.4$	$-V_S + 1.2$		$+V_S - 1.4$	V
Over Temperature	$T = -40^\circ\text{C to } +85^\circ\text{C}$	$-V_S + 1.6$		$+V_S - 1.5$	$-V_S + 1.6$		$+V_S - 1.5$	V
Short-Circuit Current			18			18		mA

Parameter	Conditions	AR Grade		BR Grade		Unit	
		Min	Typ	Max	Min		Typ
TEMPERATURE RANGE							
Specified Performance		-40		+85	-40		°C
Operating Range <sup>4</sup>		-40		+125	-40		°C

<sup>1</sup> Total RTI  $V_{OS} = (V_{OSI}) + (V_{OSO}/G)$ .

<sup>2</sup> Does not include the effects of external resistor  $R_G$ .

<sup>3</sup> One input grounded.  $G = 1$ .

<sup>4</sup> See Typical Performance Characteristics for expected operation between 85°C to 125°C.

**Table 2.**

Parameter	Conditions	ARM Grade		Unit	
		Min	Typ		Max
COMMON-MODE REJECTION RATIO (CMRR)					
CMRR DC to 60 Hz with 1 kΩ Source Imbalance	$V_{CM} = -10\text{ V to }+10\text{ V}$				
$G = 1$		80		dB	
$G = 10$		100		dB	
$G = 100$		120		dB	
$G = 1000$		130		dB	
CMRR at 10 kHz	$V_{CM} = -10\text{ V to }+10\text{ V}$				
$G = 1$		80		dB	
$G = 10$		90		dB	
$G = 100$		100		dB	
$G = 1000$		100		dB	
NOISE	$RTI\ noise = \sqrt{e_{NI}^2 + (e_{NO}/G)^2}$				
Voltage Noise, 1 kHz					
Input Voltage Noise, $e_{NI}$	$V_{IN+}, V_{IN-}, V_{REF} = 0$			8	nV/√Hz
Output Voltage Noise, $e_{NO}$				75	nV/√Hz
RTI	$f = 0.1\text{ Hz to }10\text{ Hz}$				
$G = 1$			2		μV p-p
$G = 10$			0.5		μV p-p
$G = 100\text{ to }1000$			0.25		μV p-p
Current Noise	$f = 1\text{ kHz}$		40		fA/√Hz
	$f = 0.1\text{ Hz to }10\text{ Hz}$		6		pA p-p
VOLTAGE OFFSET <sup>1</sup>					
Input Offset, $V_{OSI}$	$V_S = \pm 5\text{ V to } \pm 15\text{ V}$			70	μV
Over Temperature	$T = -40^\circ\text{C to }+85^\circ\text{C}$			135	μV
Average TC				0.9	μV/°C
Output Offset, $V_{OSO}$	$V_S = \pm 5\text{ V to } \pm 15\text{ V}$			600	μV
Over Temperature	$T = -40^\circ\text{C to }+85^\circ\text{C}$			1.00	mV
Average TC				9	μV/°C
Offset RTI vs. Supply (PSR)	$V_S = \pm 2.3\text{ V to } \pm 18\text{ V}$				
$G = 1$		90	100		dB
$G = 10$		100	120		dB
$G = 100$		120	140		dB
$G = 1000$		120	140		dB
INPUT CURRENT					
Input Bias Current			0.5	2	nA
Over Temperature	$T = -40^\circ\text{C to }+85^\circ\text{C}$			3	nA
Average TC			3		pA/°C
Input Offset Current			0.3	1	nA
Over Temperature	$T = -40^\circ\text{C to }+85^\circ\text{C}$			1.5	nA
Average TC			3		pA/°C

# AD8221

Parameter	Conditions	ARM Grade			Unit
		Min	Typ	Max	
<b>REFERENCE INPUT</b>					
$R_{IN}$	$V_{IN+}, V_{IN-}, V_{REF} = 0$		20		k $\Omega$
$I_{IN}$			50	60	$\mu$ A
Voltage Range		$-V_S$		$+V_S$	V
Gain to Output				$1 \pm 0.0001$	V/V
<b>POWER SUPPLY</b>					
Operating Range	$V_S = \pm 2.3 \text{ V to } \pm 18 \text{ V}$	$\pm 2.3$		$\pm 18$	V
Quiescent Current	$T = -40^\circ\text{C to } +85^\circ\text{C}$		0.9	1	mA
Over Temperature			1	1.2	mA
<b>DYNAMIC RESPONSE</b>					
Small Signal -3 dB Bandwidth					
$G = 1$	10 V step		825		kHz
$G = 10$			562		kHz
$G = 100$			100		kHz
$G = 1000$			14.7		kHz
Settling Time 0.01%					
$G = 1$ to 100	10 V step		10		$\mu$ s
$G = 1000$			80		$\mu$ s
Settling Time 0.001%					
$G = 1$ to 100	10 V step		13		$\mu$ s
$G = 1000$			110		$\mu$ s
Slew Rate					
$G = 1$	$G = 1$	1.5	2		V/ $\mu$ s
$G = 5$ to 100	$G = 5$ to 100	2	2.5		V/ $\mu$ s
<b>GAIN</b>					
$G = 1 + (49.4 \text{ k}\Omega/R_G)$					
Gain Range	$V_{OUT} \pm 10 \text{ V}$	1		1000	V/V
Gain Error				0.1	%
$G = 10$				0.3	%
$G = 100$				0.3	%
$G = 1000$			0.3	%	
Gain Nonlinearity					
$G = 1$ to 10	$V_{OUT} = -10 \text{ V to } +10 \text{ V}$ $R_L = 10 \text{ k}\Omega$		5	15	ppm
$G = 100$			7	20	ppm
$G = 1000$			10	50	ppm
$G = 1$ to 100		$R_L = 2 \text{ k}\Omega$	15	100	ppm
Gain vs. Temperature					
$G = 1$			3	10	ppm/ $^\circ\text{C}$
$G > 1^2$				-50	ppm/ $^\circ\text{C}$
<b>INPUT</b>					
Input Impedance					
Differential			100  2		G $\Omega$ /pF
Common Mode				100  2	
Input Operating Voltage Range <sup>3</sup>					
Over Temperature	$V_S = \pm 2.3 \text{ V to } \pm 5 \text{ V}$ $T = -40^\circ\text{C to } +85^\circ\text{C}$	$-V_S + 1.9$		$+V_S - 1.1$	V
Over Temperature		$-V_S + 2.0$		$+V_S - 1.2$	V
Input Operating Voltage Range					
Over Temperature	$V_S = \pm 5 \text{ V to } \pm 18 \text{ V}$ $T = -40^\circ\text{C to } +85^\circ\text{C}$	$-V_S + 1.9$		$+V_S - 1.2$	V
Over Temperature		$-V_S + 2.0$		$+V_S - 1.2$	V

Parameter	Conditions	ARM Grade			Unit
		Min	Typ	Max	
OUTPUT	$R_L = 10\text{ k}\Omega$				
Output Swing	$V_S = \pm 2.3\text{ V to } \pm 5\text{ V}$	$-V_S + 1.1$		$+V_S - 1.2$	V
Over Temperature	$T = -40^\circ\text{C to } +85^\circ\text{C}$	$-V_S + 1.4$		$+V_S - 1.3$	V
Output Swing	$V_S = \pm 5\text{ V to } \pm 18\text{ V}$	$-V_S + 1.2$		$+V_S - 1.4$	V
Over Temperature	$T = -40^\circ\text{C to } +85^\circ\text{C}$	$-V_S + 1.6$		$+V_S - 1.5$	V
Short-Circuit Current			18		mA
TEMPERATURE RANGE					
Specified Performance		-40		+85	$^\circ\text{C}$
Operating Range <sup>4</sup>		-40		+125	$^\circ\text{C}$

<sup>1</sup> Total RTI  $V_{OS} = (V_{OSI}) + (V_{OSO}/G)$ .

<sup>2</sup> Does not include the effects of external resistor  $R_G$ .

<sup>3</sup> One input grounded.  $G = 1$ .

<sup>4</sup> See Typical Performance Characteristics for expected operation between  $85^\circ\text{C}$  to  $125^\circ\text{C}$ .

# AD8221

## ABSOLUTE MAXIMUM RATINGS

Table 3.

Parameter	Rating
Supply Voltage	$\pm 18$ V
Internal Power Dissipation	200 mW
Output Short-Circuit Current	Indefinite
Input Voltage (Common-Mode)	$\pm V_S$
Differential Input Voltage	$\pm V_S$
Storage Temperature Range	$-65^{\circ}\text{C}$ to $+150^{\circ}\text{C}$
Operating Temperature Range <sup>1</sup>	$-40^{\circ}\text{C}$ to $+125^{\circ}\text{C}$

<sup>1</sup> Temperature range for specified performance is  $-40^{\circ}\text{C}$  to  $+85^{\circ}\text{C}$ . See Typical Performance Characteristics for expected operation from  $85^{\circ}\text{C}$  to  $125^{\circ}\text{C}$ .

Stresses above those listed under Absolute Maximum Ratings may cause permanent damage to the device. This is a stress rating only; functional operation of the device at these or any other conditions above those indicated in the operational section of this specification is not implied. Exposure to absolute maximum rating conditions for extended periods may affect device reliability.

### THERMAL CHARACTERISTICS

Specification for a device in free air.

Table 4.

Package	$\theta_{JA}$	Unit
8-Lead SOIC, 4-Layer JEDEC Board	121	$^{\circ}\text{C}/\text{W}$
8-Lead MSOP, 4-Layer JEDEC Board	135	$^{\circ}\text{C}/\text{W}$

### ESD CAUTION



**ESD (electrostatic discharge) sensitive device.** Charged devices and circuit boards can discharge without detection. Although this product features patented or proprietary protection circuitry, damage may occur on devices subjected to high energy ESD. Therefore, proper ESD precautions should be taken to avoid performance degradation or loss of functionality.



## PIN CONFIGURATION AND FUNCTION DESCRIPTIONS

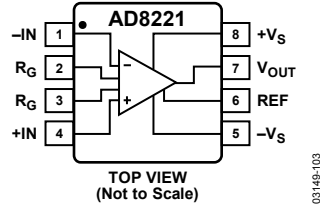

Figure 3. Pin Configuration

Table 5. Pin Function Descriptions

Pin No.	Mnemonic	Description
1	-IN	Negative Input Terminal.
2	R <sub>G</sub>	Gain Setting Terminal. Place resistor across the R <sub>G</sub> pins to set the gain. $G = 1 + (49.4 \text{ k}\Omega / R_G)$ .
3	R <sub>G</sub>	Gain Setting Terminal. Place resistor across the R <sub>G</sub> pins to set the gain. $G = 1 + (49.4 \text{ k}\Omega / R_G)$ .
4	+IN	Positive Input Terminal.
5	-V <sub>S</sub>	Negative Power Supply Terminal.
6	REF	Reference Voltage Terminal. Drive this terminal with a low impedance voltage source to level-shift the output.
7	V <sub>OUT</sub>	Output Terminal.
8	+V <sub>S</sub>	Positive Power Supply Terminal.

# AD8221

## TYPICAL PERFORMANCE CHARACTERISTICS

T = 25°C, V<sub>S</sub> = ±15 V, R<sub>L</sub> = 10 kΩ, unless otherwise noted.

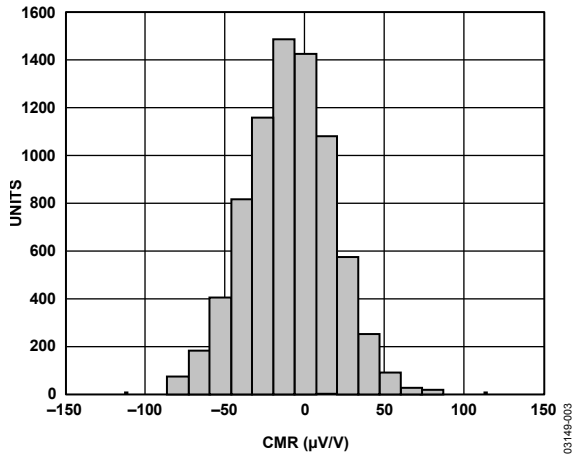

Figure 4. Typical Distribution for CMR (G = 1)

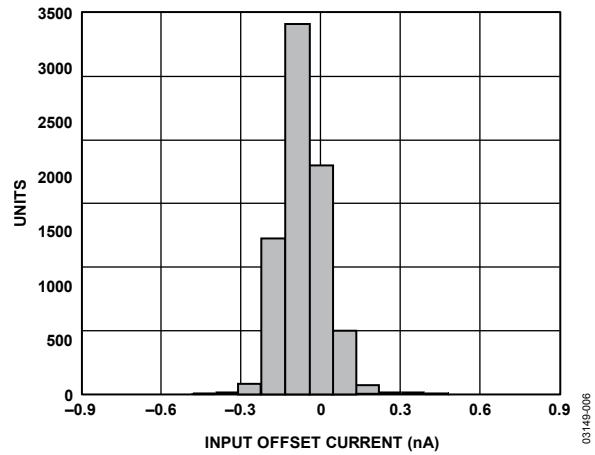

Figure 7. Typical Distribution of Input Offset Current

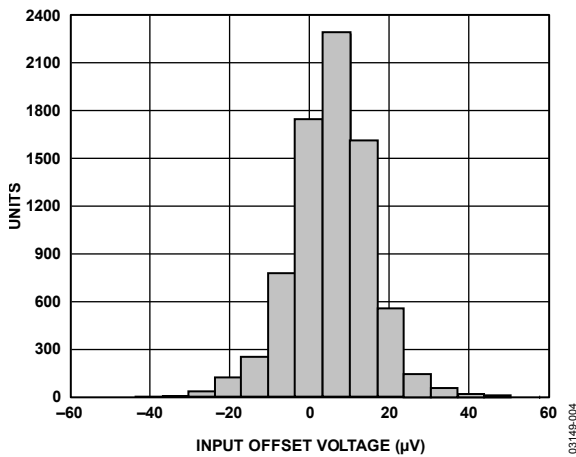

Figure 5. Typical Distribution of Input Offset Voltage

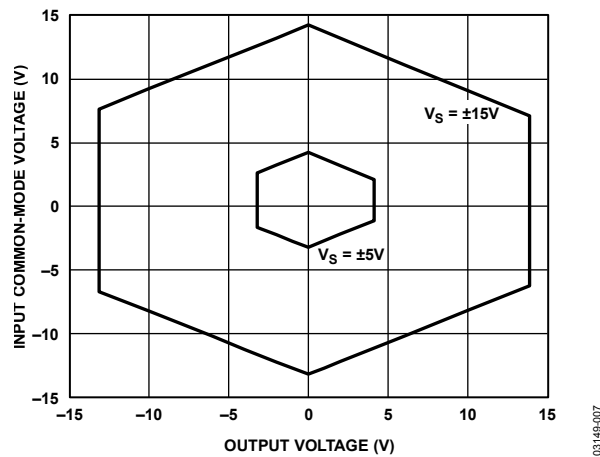

Figure 8. Input Common-Mode Range vs. Output Voltage, G = 1

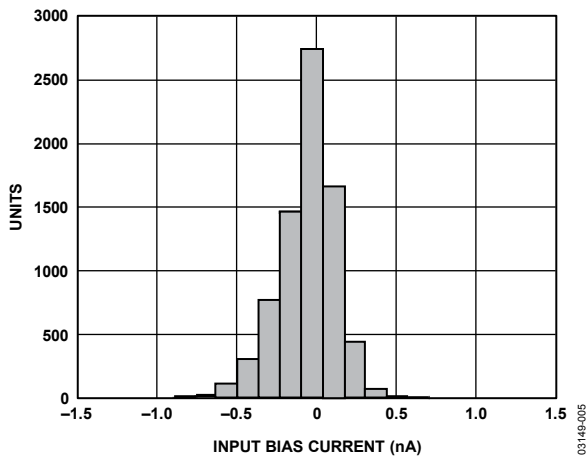

Figure 6. Typical Distribution of Input Bias Current

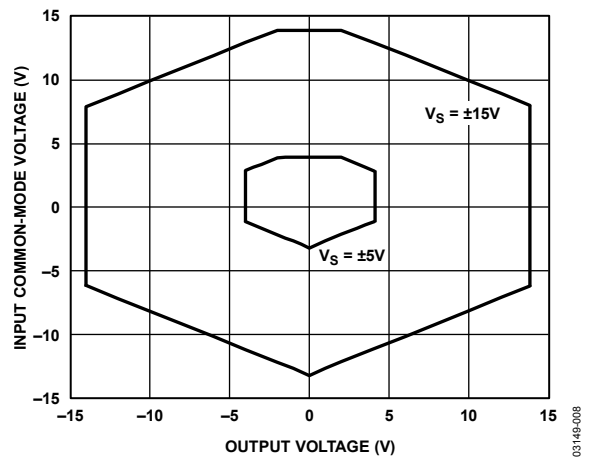

Figure 9. Input Common-Mode Range vs. Output Voltage, G = 100

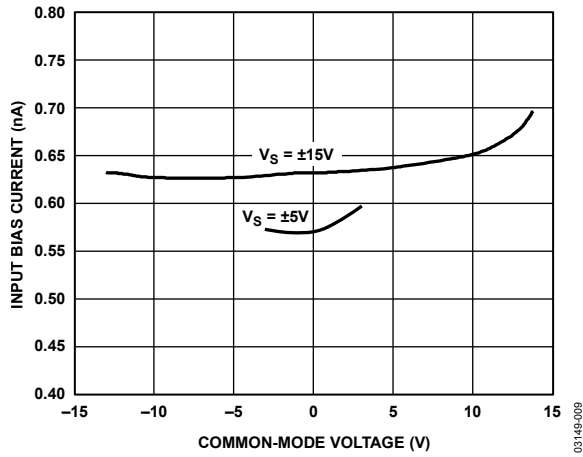

Figure 10.  $I_{BIAS}$  vs. CMV

03149-009

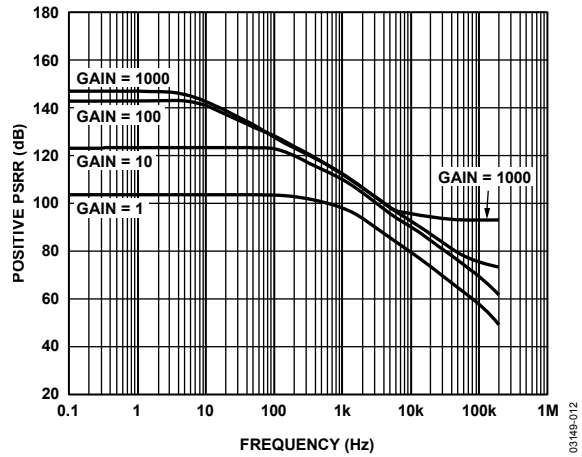

Figure 13. Positive PSRR vs. Frequency, RTI ( $G = 1$  to 1000)

03149-012

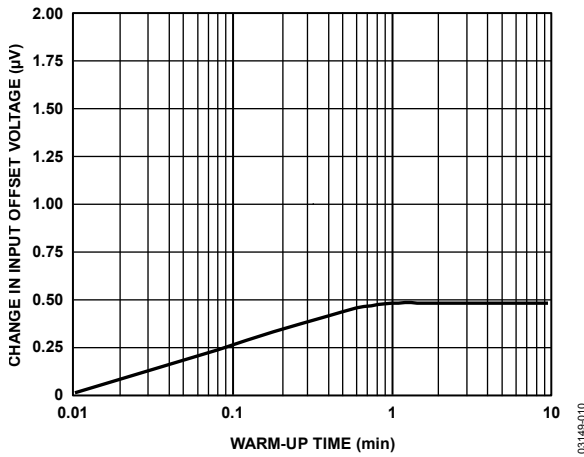

Figure 11. Change in Input Offset Voltage vs. Warm-Up Time

03149-010

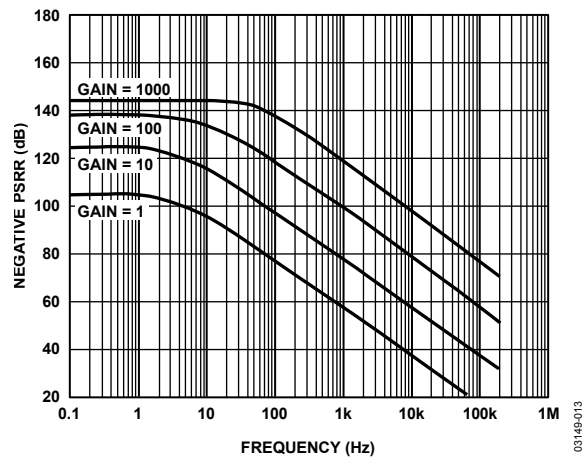

Figure 14. Negative PSRR vs. Frequency, RTI ( $G = 1$  to 1000)

03149-013

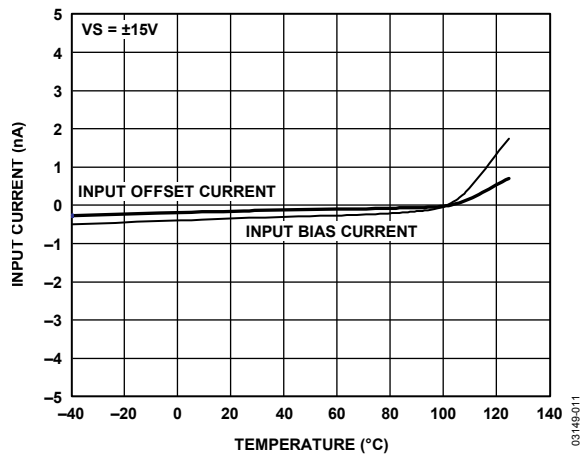

Figure 12. Input Bias Current and Offset Current vs. Temperature

03149-011

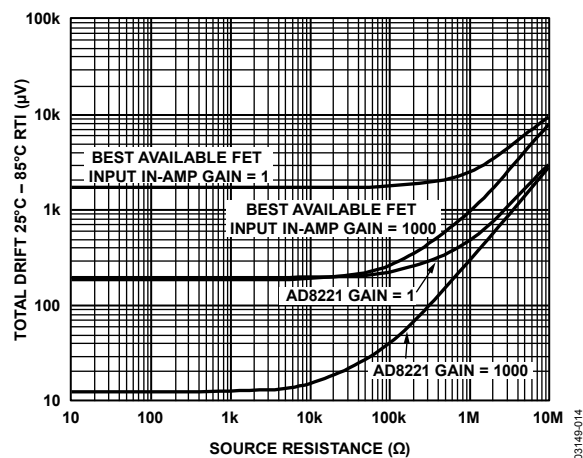

Figure 15. Total Drift vs. Source Resistance

03149-014

# AD8221

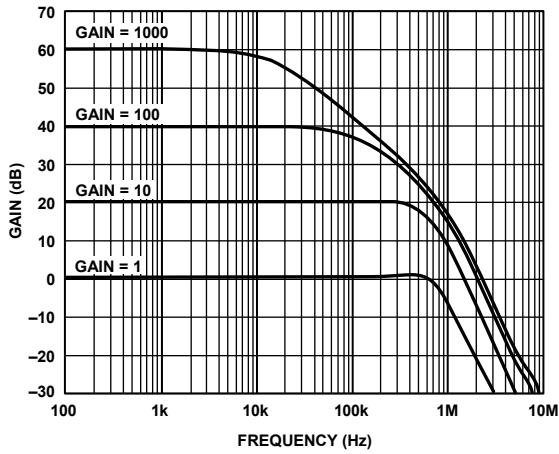

Figure 16. Gain vs. Frequency

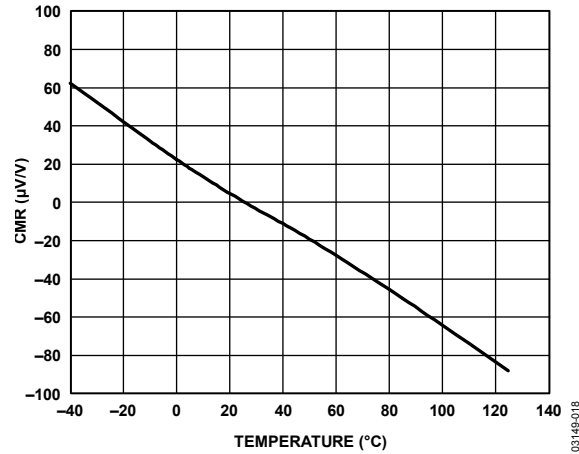

Figure 19. CMR vs. Temperature

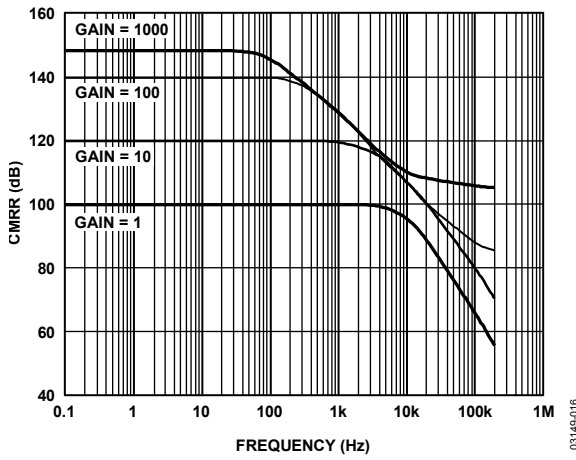

Figure 17. CMRR vs. Frequency, RTI

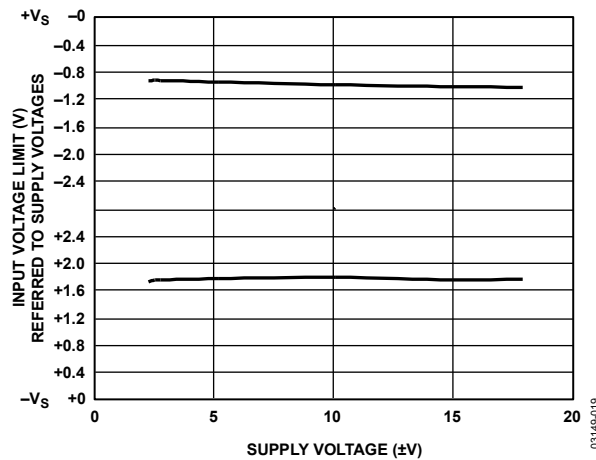

Figure 20. Input Voltage Limit vs. Supply Voltage, G = 1

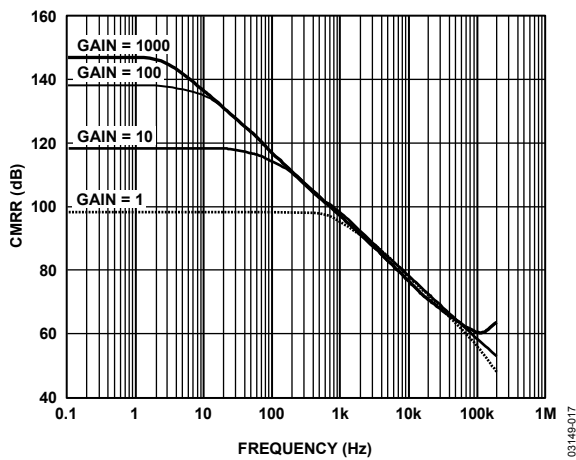

Figure 18. CMRR vs. Frequency, RTI, 1 kΩ Source Imbalance

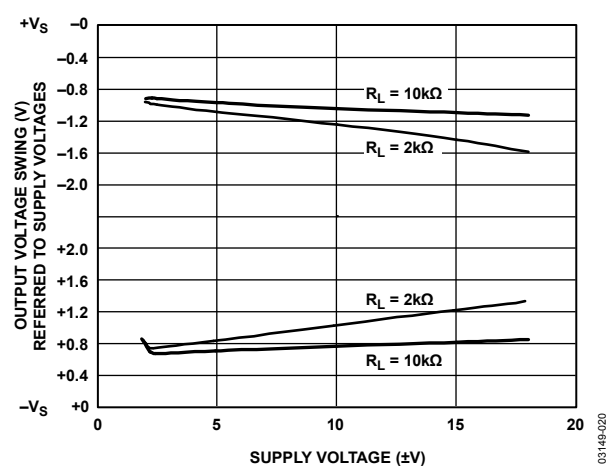

Figure 21. Output Voltage Swing vs. Supply Voltage, G = 1

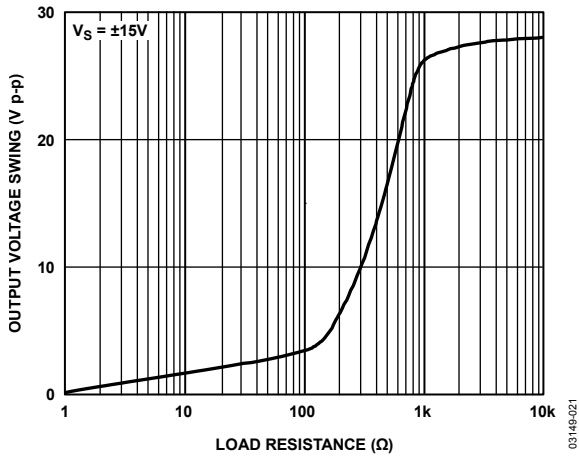

Figure 22. Output Voltage Swing vs. Load Resistance

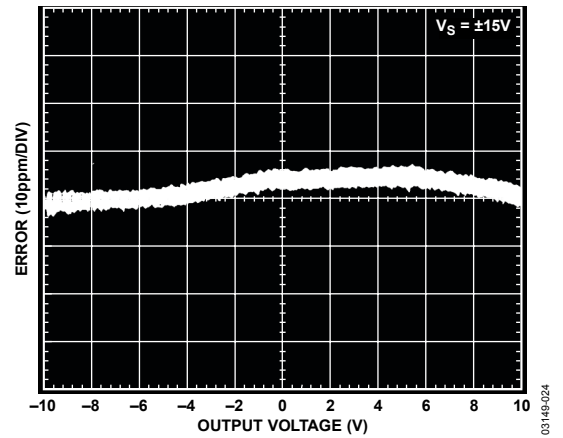

Figure 25. Gain Nonlinearity,  $G = 100$ ,  $R_L = 10\text{ k}\Omega$

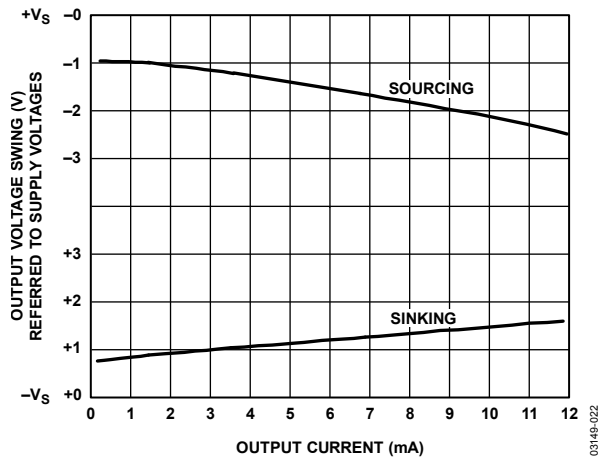

Figure 23. Output Voltage Swing vs. Output Current,  $G = 1$

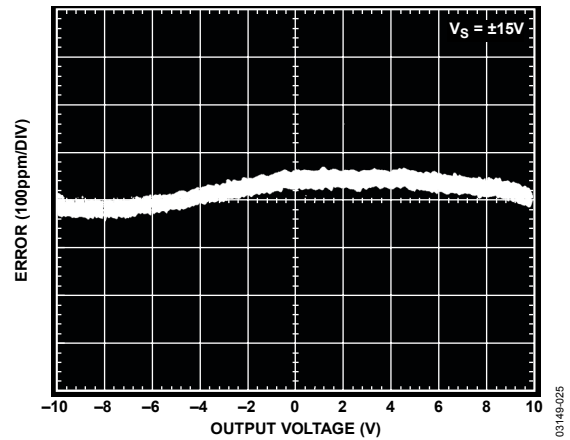

Figure 26. Gain Nonlinearity,  $G = 1000$ ,  $R_L = 10\text{ k}\Omega$

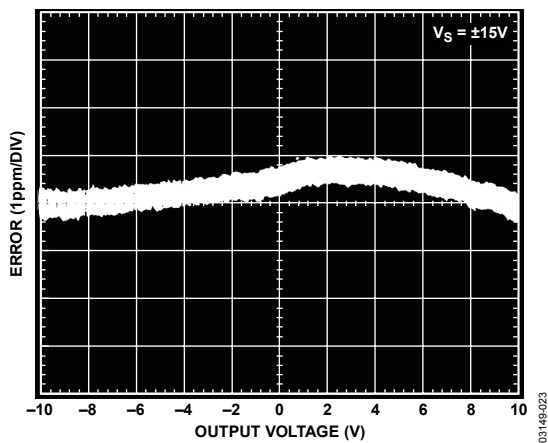

Figure 24. Gain Nonlinearity,  $G = 1$ ,  $R_L = 10\text{ k}\Omega$

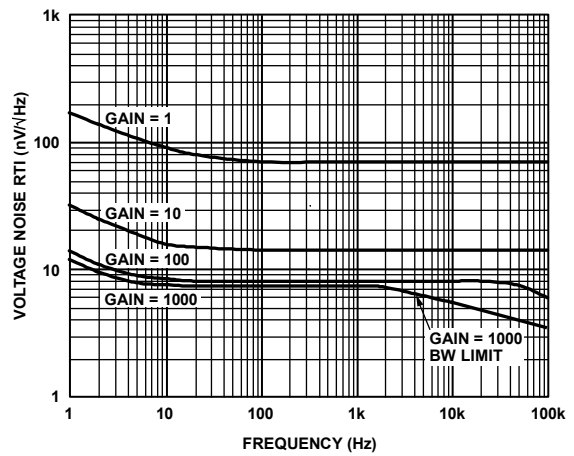

Figure 27. Voltage Noise Spectral Density vs. Frequency ( $G = 1$  to  $1000$ )

# AD8221

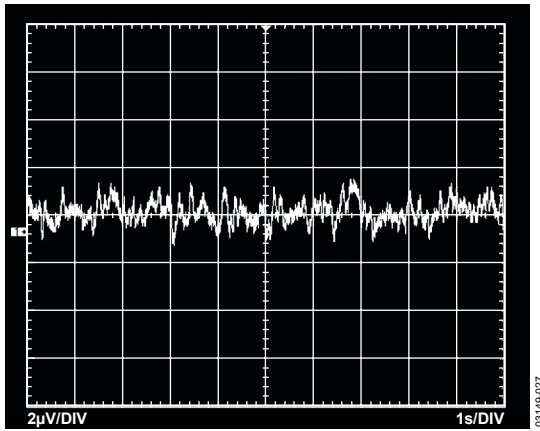

Figure 28. 0.1 Hz to 10 Hz RTI Voltage Noise (G = 1)

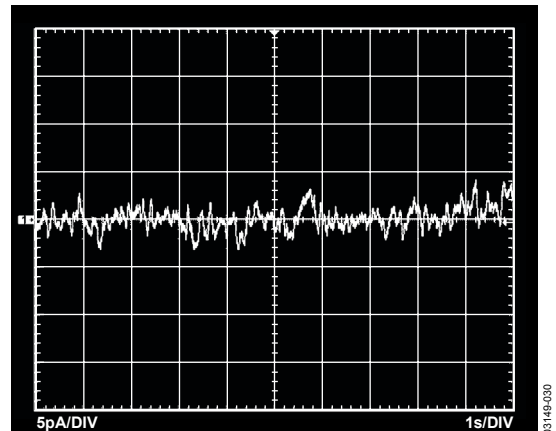

Figure 31. 0.1 Hz to 10 Hz Current Noise

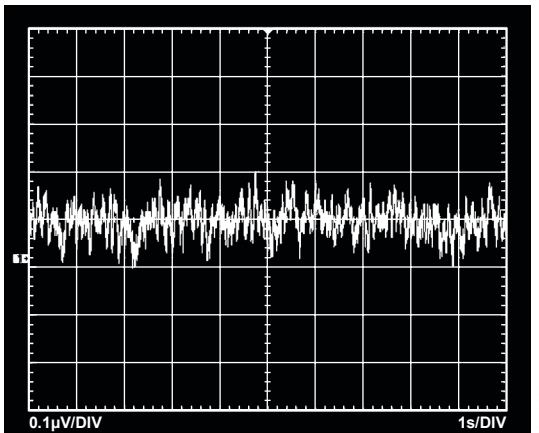

Figure 29. 0.1 Hz to 10 Hz RTI Voltage Noise (G = 1000)

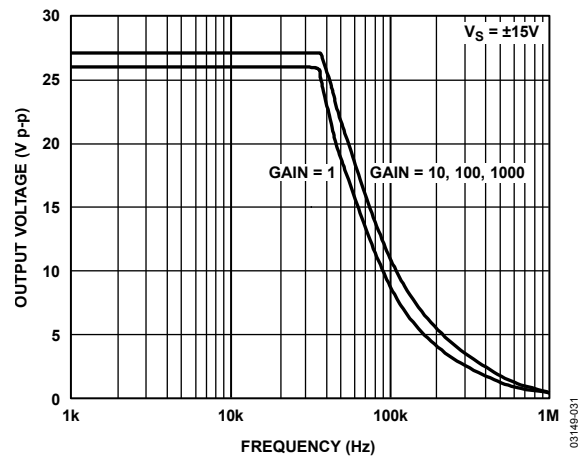

Figure 32. Large Signal Frequency Response

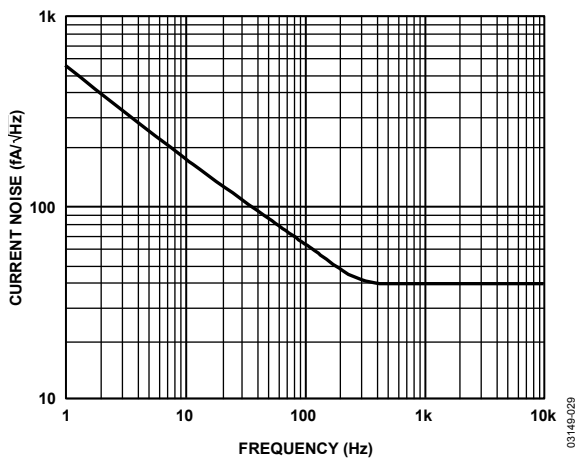

Figure 30. Current Noise Spectral Density vs. Frequency

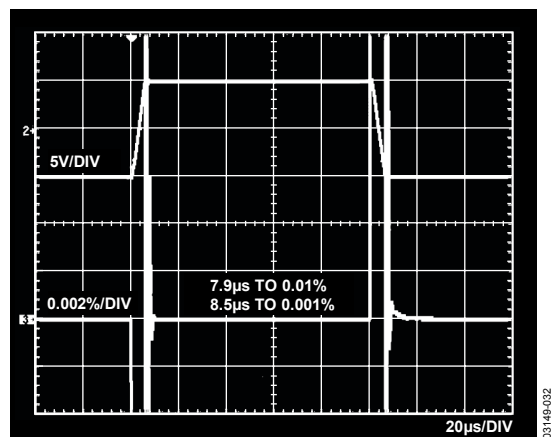

Figure 33. Large Signal Pulse Response and Settling Time (G = 1), 0.002%/DIV

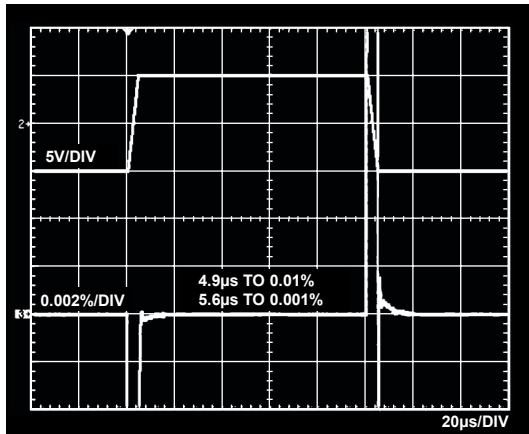

Figure 34. Large Signal Pulse Response and Settling Time ( $G = 10$ ), 0.002%/DIV

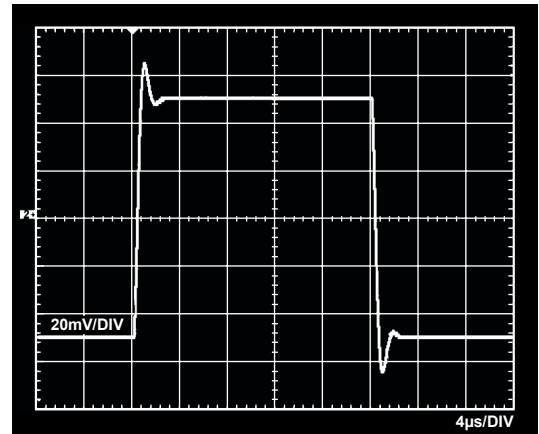

Figure 37. Small Signal Response,  $G = 1$ ,  $R_L = 2\text{ k}\Omega$ ,  $C_L = 100\text{ pF}$

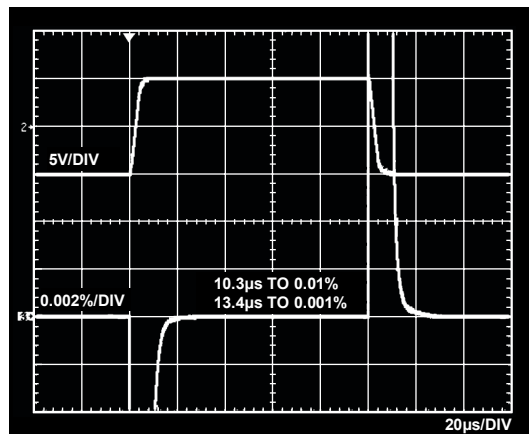

Figure 35. Large Signal Pulse Response and Settling Time ( $G = 100$ ), 0.002%/DIV

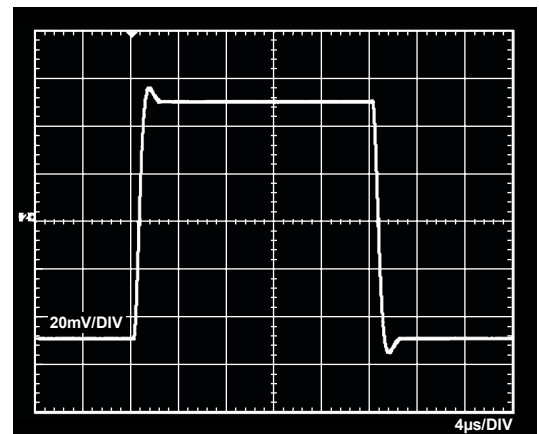

Figure 38. Small Signal Response,  $G = 10$ ,  $R_L = 2\text{ k}\Omega$ ,  $C_L = 100\text{ pF}$

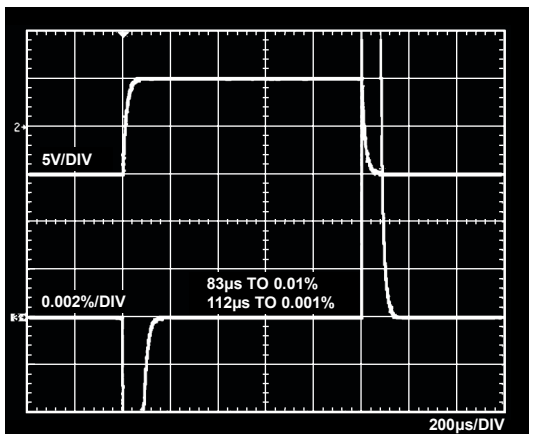

Figure 36. Large Signal Pulse Response and Settling Time ( $G = 1000$ ), 0.002%/DIV

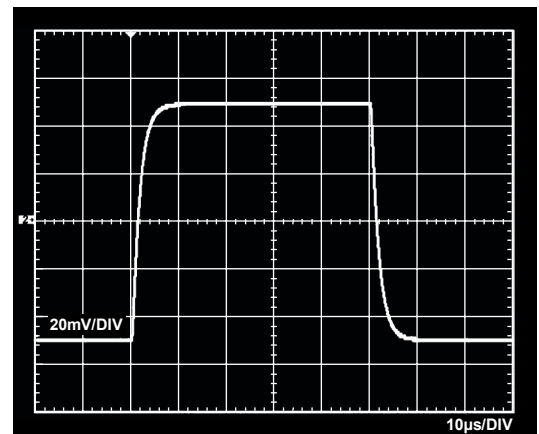

Figure 39. Small Signal Response,  $G = 100$ ,  $R_L = 2\text{ k}\Omega$ ,  $C_L = 100\text{ pF}$

# AD8221

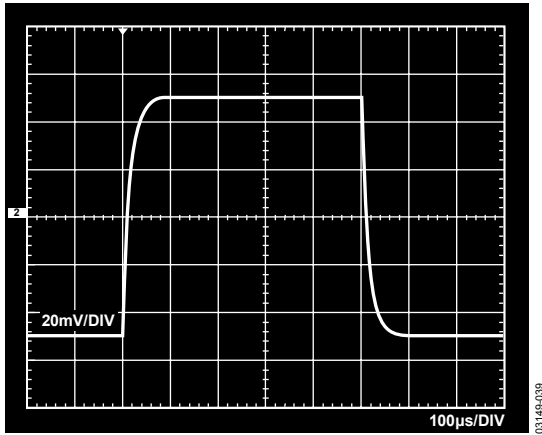

Figure 40. Small Signal Response,  $G = 1000$ ,  $R_L = 2\text{ k}\Omega$ ,  $C_L = 100\text{ pF}$

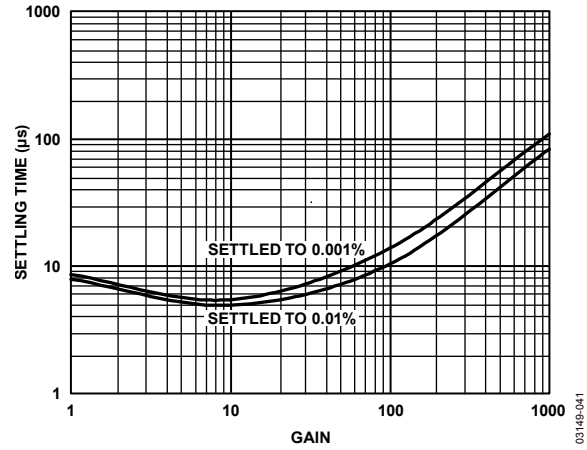

Figure 42. Settling Time vs. Gain for a 10 V Step

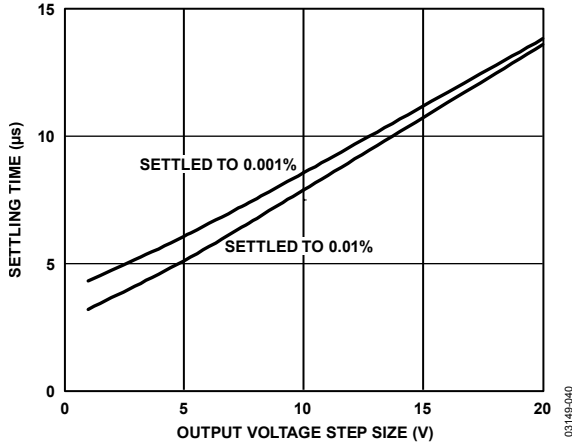

Figure 41. Settling Time vs. Step Size ( $G = 1$ )



## THEORY OF OPERATION

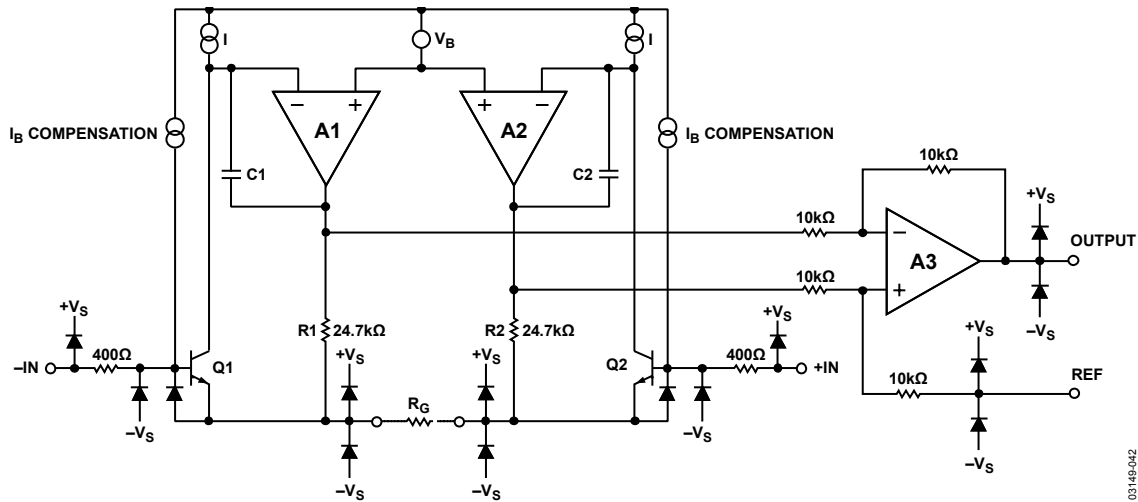

Figure 43. Simplified Schematic

The AD8221 is a monolithic instrumentation amplifier based on the classic 3-op amp topology. Input transistors Q1 and Q2 are biased at a fixed current so that any differential input signal forces the output voltages of A1 and A2 to change accordingly. A signal applied to the input creates a current through  $R_G$ , R1, and R2, such that the outputs of A1 and A2 deliver the correct voltage. Topologically, Q1, A1, R1 and Q2, A2, R2 can be viewed as precision current feedback amplifiers. The amplified differential and common-mode signals are applied to a difference amplifier that rejects the common-mode voltage but amplifies the differential voltage. The difference amplifier employs innovations that result in low output offset voltage as well as low output offset voltage drift. Laser-trimmed resistors allow for a highly accurate in-amp with gain error typically less than 20 ppm and CMRR that exceeds 90 dB ( $G = 1$ ).

Using superbeta input transistors and an  $I_B$  compensation scheme, the AD8221 offers extremely high input impedance, low  $I_B$ , low  $I_B$  drift, low  $I_{OS}$ , low input bias current noise, and extremely low voltage noise of  $8 \text{ nV}/\sqrt{\text{Hz}}$ .

The transfer function of the AD8221 is

$$G = 1 + \frac{49.4 \text{ k}\Omega}{R_G}$$

Users can easily and accurately set the gain using a single standard resistor.

Because the input amplifiers employ a current feedback architecture, the gain-bandwidth product of the AD8221 increases with gain, resulting in a system that does not suffer from the expected bandwidth loss of voltage feedback architectures at higher gains.

To maintain precision even at low input levels, special attention was given to the design and layout of the AD8221, resulting in an in-amp whose performance satisfies the most demanding applications.

A unique pinout enables the AD8221 to meet a CMRR specification of 80 dB at 10 kHz ( $G = 1$ ) and 110 dB at 1 kHz ( $G = 1000$ ). The balanced pinout, shown in Figure 44, reduces the parasitics that had, in the past, adversely affected CMRR performance. In addition, the new pinout simplifies board layout because associated traces are grouped together. For example, the gain setting resistor pins are adjacent to the inputs, and the reference pin is next to the output.

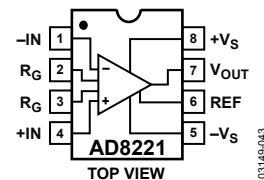

Figure 44. Pinout Diagram

# AD8221

## GAIN SELECTION

Placing a resistor across the  $R_G$  terminals set the gain of AD8221, which can be calculated by referring to Table 6 or by using the gain equation.

$$R_G = \frac{49.4 \text{ k}\Omega}{G - 1}$$

**Table 6. Gains Achieved Using 1% Resistors**

1% Standard Table Value of $R_G$ ( $\Omega$ )	Calculated Gain
49.9 k	1.990
12.4 k	4.984
5.49 k	9.998
2.61 k	19.93
1.00 k	50.40
499	100.0
249	199.4
100	495.0
49.9	991.0

The AD8221 defaults to  $G = 1$  when no gain resistor is used. Gain accuracy is determined by the absolute tolerance of  $R_G$ . The TC of the external gain resistor increases the gain drift of the instrumentation amplifier. Gain error and gain drift are kept to a minimum when the gain resistor is not used.

## LAYOUT

Careful board layout maximizes system performance. Traces from the gain setting resistor to the  $R_G$  pins should be kept as short as possible to minimize parasitic inductance. To ensure the most accurate output, the trace from the REF pin should either be connected to the local ground of the AD8221, as shown in Figure 47, or connected to a voltage that is referenced to the local ground of the AD8221.

### Common-Mode Rejection

One benefit of the high CMRR over frequency of the AD8221 is that it has greater immunity to disturbances, such as line noise and its associated harmonics, than do typical instrumentation amplifiers. Typically, these amplifiers have CMRR fall-off at 200 Hz; common-mode filters are often used to compensate for this shortcoming. The AD8221 is able to reject CMRR over a greater frequency range, reducing the need for filtering.

A well implemented layout helps to maintain the high CMRR over frequency of the AD8221. Input source impedance and capacitance should be closely matched. In addition, source resistance and capacitance should be placed as close to the inputs as permissible.

## Grounding

The output voltage of the AD8221 is developed with respect to the potential on the reference terminal. Care should be taken to tie REF to the appropriate local ground.

In mixed-signal environments, low level analog signals need to be isolated from the noisy digital environment. Many ADCs have separate analog and digital ground pins. Although it is convenient to tie both grounds to a single ground plane, the current traveling through the ground wires and PC board may cause hundreds of millivolts of error. Therefore, separate analog and digital ground returns should be used to minimize the current flow from sensitive points to the system ground. An example layout is shown in Figure 45 and Figure 46.

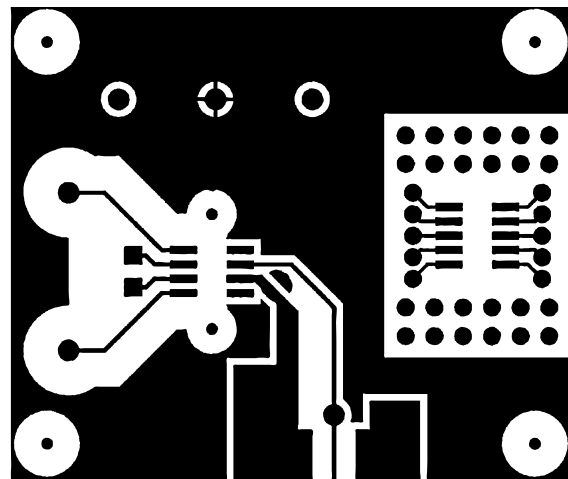

Figure 45. Top Layer of the AD8221-EVAL

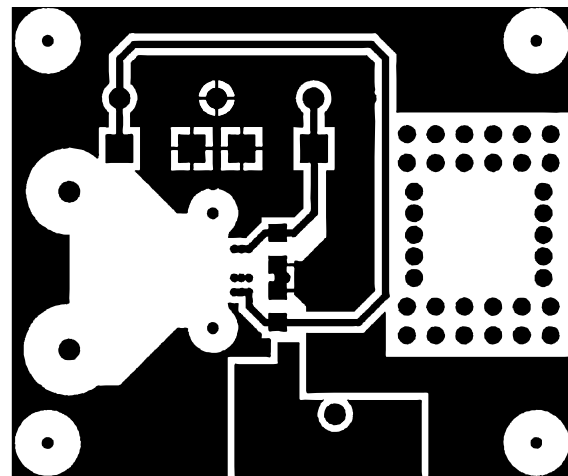

Figure 46. Bottom Layer of the AD8221-EVAL

## REFERENCE TERMINAL

As shown in Figure 43, the reference terminal, REF, is at one end of a 10 k $\Omega$  resistor. The output of the instrumentation amplifier is referenced to the voltage on the REF terminal; this is useful when the output signal needs to be offset to a precise midsupply level. For example, a voltage source can be tied to the REF pin to level-shift the output so that the AD8221 can interface with an ADC. The allowable reference voltage range is a function of the gain, input, and supply voltage. The REF pin should not exceed either +V<sub>S</sub> or -V<sub>S</sub> by more than 0.5 V.

For best performance, source impedance to the REF terminal should be kept low, because parasitic resistance can adversely affect CMRR and gain accuracy.

## POWER SUPPLY REGULATION AND BYPASSING

A stable dc voltage should be used to power the instrumentation amplifier. Noise on the supply pins can adversely affect performance. Bypass capacitors should be used to decouple the amplifier.

A 0.1  $\mu$ F capacitor should be placed close to each supply pin. As shown in Figure 47, a 10  $\mu$ F tantalum capacitor can be used further away from the part. In most cases, it can be shared by other precision integrated circuits.

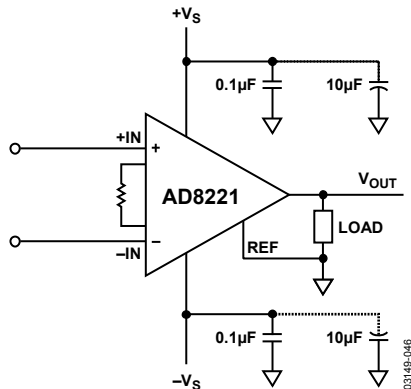
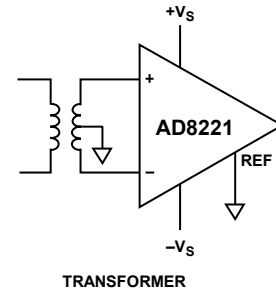

Figure 47. Supply Decoupling, REF, and Output Referred to Local Ground

## INPUT BIAS CURRENT RETURN PATH

The input bias current of the AD8221 must have a return path to common. When the source, such as a thermocouple, cannot provide a return current path, one should be created, as shown in Figure 48.



TRANSFORMER

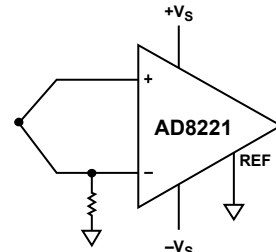

THERMOCOUPLE

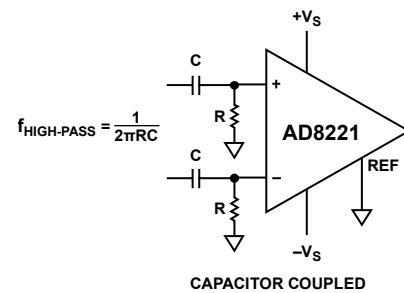

CAPACITOR COUPLED

Figure 48. Creating an I<sub>BIAS</sub> Path

## INPUT PROTECTION

All terminals of the AD8221 are protected against ESD, 1 kV Human Body Model. In addition, the input structure allows for dc overload conditions below the negative supply, -V<sub>S</sub>. The internal 400  $\Omega$  resistors limit current in the event of a negative fault condition. However, in the case of a dc overload voltage above the positive supply, +V<sub>S</sub>, a large current flows directly through the ESD diode to the positive rail. Therefore, an external resistor should be used in series with the input to limit current for voltages above +V<sub>S</sub>. In either scenario, the AD8221 can safely handle a continuous 6 mA current,  $I = V_{IN}/R_{EXT}$  for positive overvoltage and  $I = V_{IN}/(400 \Omega + R_{EXT})$  for negative overvoltage.

For applications where the AD8221 encounters extreme overload voltages, as in cardiac defibrillators, external series resistors, and low leakage diode clamps, such as BAV199Ls, FJH1100s, or SP720s should be used.

# AD8221

## RF INTERFERENCE

RF rectification is often a problem when amplifiers are used in applications where there are strong RF signals. The disturbance can appear as a small dc offset voltage. High frequency signals can be filtered with a low-pass RC network placed at the input of the instrumentation amplifier, as shown in Figure 49. The filter limits the input signal bandwidth according to the following relationship:

$$FilterFreq_{diff} = \frac{1}{2\pi R(2C_D + C_C)}$$

$$FilterFreq_{CM} = \frac{1}{2\pi RC_C}$$

where  $C_D \geq 10C_C$ .

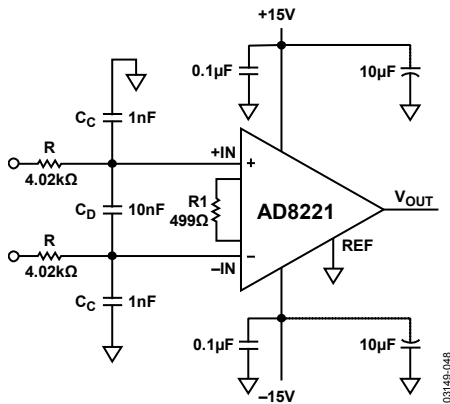

Figure 49. RF Interference Suppression

$C_D$  affects the difference signal, and  $C_C$  affects the common-mode signal. Values of  $R$  and  $C_C$  should be chosen to minimize RFI. Mismatch between the  $R \times C_C$  at the positive input and the  $R \times C_C$  at the negative input degrades the CMRR of the AD8221. By using a value of  $C_D$  one magnitude larger than  $C_C$ , the effect of the mismatch is reduced, and therefore, performance is improved.

## PRECISION STRAIN GAGE

The low offset and high CMRR over frequency of the AD8221 make it an excellent candidate for bridge measurements. As shown in Figure 50, the bridge can be directly connected to the inputs of the amplifier.

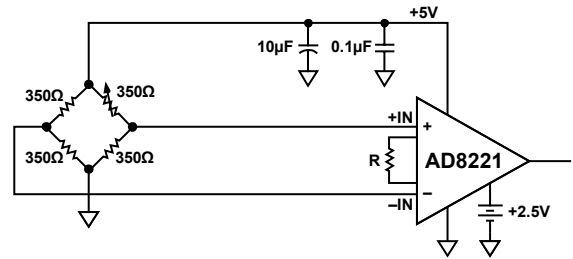

Figure 50. Precision Strain Gage

## CONDITIONING ±10 V SIGNALS FOR A +5 V DIFFERENTIAL INPUT ADC

There is a need in many applications to condition ±10 V signals. However, many of today's ADCs and digital ICs operate on much lower, single-supply voltages. Furthermore, new ADCs have differential inputs because they provide better common-mode rejection, noise immunity, and performance at low supply voltages. Interfacing a ±10 V, single-ended instrumentation amplifier to a +5 V, differential ADC can be a challenge. Interfacing the instrumentation amplifier to the ADC requires attenuation and a level shift. A solution is shown in Figure 51.

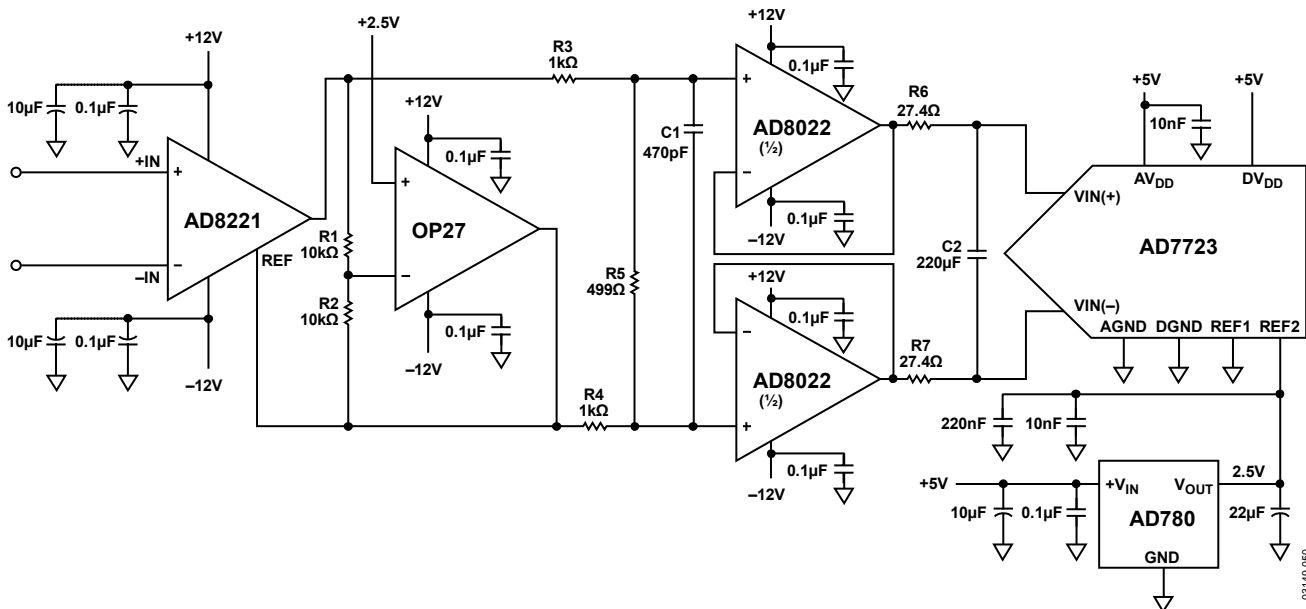

Figure 51. Interfacing to a Differential Input ADC

In this topology, an OP27 sets the reference voltage of the AD8221. The output signal of the instrumentation amplifier is taken across the OUT pin and the REF pin. Two 1 k $\Omega$  resistors and a 499  $\Omega$  resistor attenuate the  $\pm 10$  V signal to +4 V. An optional capacitor, C1, can serve as an antialiasing filter. An AD8022 is used to drive the ADC.

This topology has five benefits. In addition to level-shifting and attenuation, very little noise is contributed to the system. Noise from R1 and R2 is common to both of the inputs of the ADC and is easily rejected. R5 adds a third of the dominant noise and therefore makes a negligible contribution to the noise of the system. The attenuator divides the noise from R3 and R4. Likewise, its noise contribution is negligible. The fourth benefit of this interface circuit is that the acquisition time of the AD8221 is reduced by a factor of 2. With the help of the OP27, the AD8221 only needs to deliver one-half of the full swing; therefore, signals can settle more quickly. Lastly, the AD8022 settles quickly, which is helpful because the shorter the settling time, the more bits that can be resolved when the ADC acquires data. This configuration provides attenuation, a level-shift, and a convenient interface with a differential input ADC while maintaining performance.

### AC-COUPLED INSTRUMENTATION AMPLIFIER

Measuring small signals that are in the noise or offset of the amplifier can be a challenge. Figure 52 shows a circuit that can improve the resolution of small ac signals. The large gain

reduces the referred input noise of the amplifier to 8 nV/ $\sqrt{\text{Hz}}$ . Thus, smaller signals can be measured because the noise floor is lower. DC offsets that would have been gained by 100 are eliminated from the output of the AD8221 by the integrator feedback network.

At low frequencies, the OP1177 forces the output of the AD8221 to 0 V. Once a signal exceeds  $f_{\text{HIGH-PASS}}$ , the AD8221 outputs the amplified input signal.

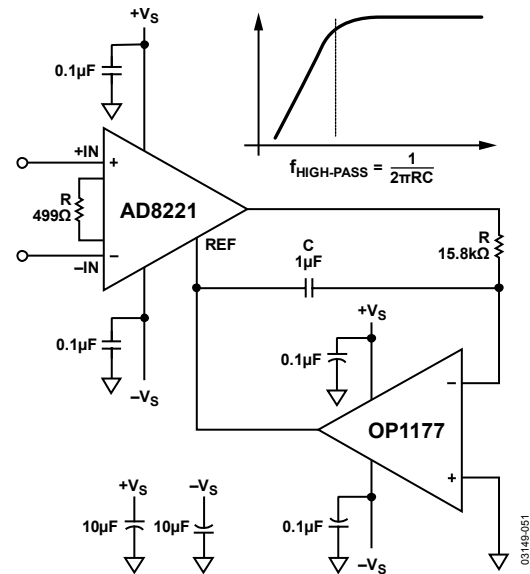

Figure 52. AC-Coupled Circuit

# AD8221

## DIE INFORMATION

Die size: 1575  $\mu\text{m}$   $\times$  2230  $\mu\text{m}$

Die thickness: 381  $\mu\text{m}$

To minimize gain errors introduced by the bond wires, use Kelvin connections between the chip and the gain resistor,  $R_G$ , by connecting Pad 2A and Pad 2B in parallel to one end of  $R_G$  and Pad 3A and Pad 3B in parallel to the other end of  $R_G$ . For unity gain applications where  $R_G$  is not required, Pad 2A and Pad 2B must be bonded together as well as the Pad 3A and Pad 3B.

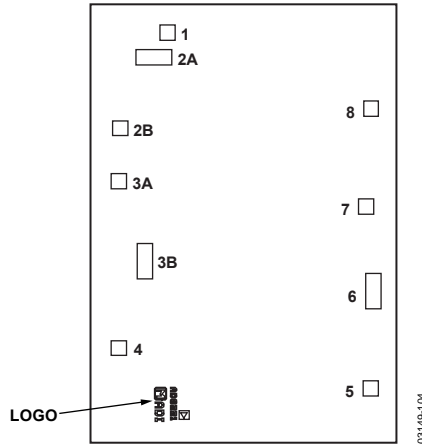

Figure 53. Bond Pad Diagram

Table 7. Bond Pad Information

Pad No.	Mnemonic	Pad Coordinates <sup>1</sup>	
		X ( $\mu\text{m}$ )	Y ( $\mu\text{m}$ )
1	-IN	-379	+951
2A	$R_G$	-446	+826
2B	$R_G$	-615	+474
3A	$R_G$	-619	+211
3B	$R_G$	-490	-190
4	+IN	-621	-622
5	$-V_S$	+635	-823
6	REF	+649	-339
7	$V_{OUT}$	+612	+84
8	$+V_S$	+636	+570

<sup>1</sup> The pad coordinates indicate the center of each pad, referenced to the center of the die. The die orientation is indicated by the logo, as shown in Figure 53.

# OUTLINE DIMENSIONS

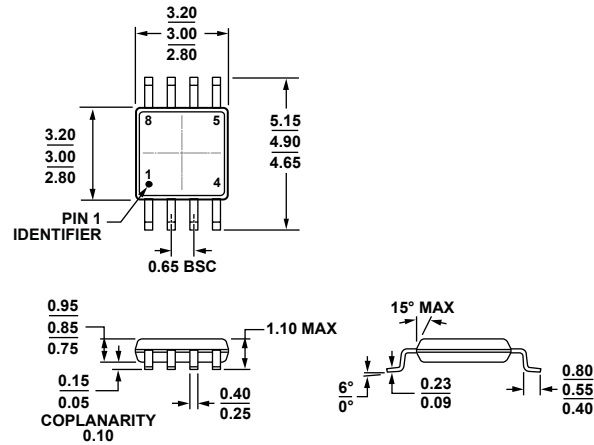

COMPLIANT TO JEDEC STANDARDS MO-187-AA

Figure 54. 8-Lead Mini Small Outline Package [MSOP] (RM-8)

Dimensions shown in millimeters

10-07-2009-B

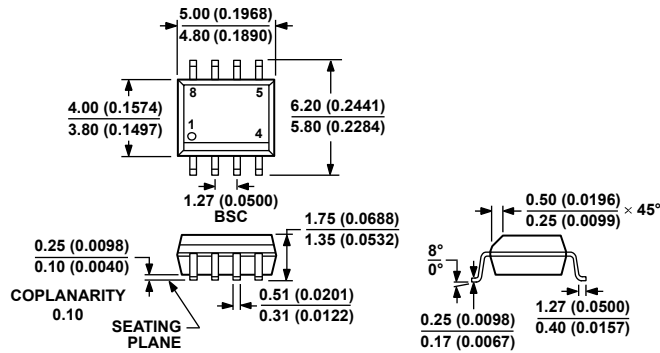

COMPLIANT TO JEDEC STANDARDS MS-012-AA  
CONTROLLING DIMENSIONS ARE IN MILLIMETERS; INCH DIMENSIONS (IN PARENTHESES) ARE ROUNDED-OFF MILLIMETER EQUIVALENTS FOR REFERENCE ONLY AND ARE NOT APPROPRIATE FOR USE IN DESIGN.

Figure 55. 8-Lead Standard Small Outline Package [SOIC\_N] Narrow Body (R-8)

Dimensions shown in millimeters and (inches)

012407-A

# AD8221

## ORDERING GUIDE

Model <sup>1</sup>	Temperature Range for Specified Performance	Operating <sup>2</sup> Temperature Range	Package Description	Package Option	Branding
AD8221AR	-40°C to +85°C	-40°C to +125°C	8-Lead SOIC_N	R-8	
AD8221AR-REEL	-40°C to +85°C	-40°C to +125°C	8-Lead SOIC_N, 13" Tape and Reel	R-8	
AD8221AR-REEL7	-40°C to +85°C	-40°C to +125°C	8-Lead SOIC_N, 7" Tape and Reel	R-8	
AD8221ARZ	-40°C to +85°C	-40°C to +125°C	8-Lead SOIC_N	R-8	
AD8221ARZ-R7	-40°C to +85°C	-40°C to +125°C	8-Lead SOIC_N, 7" Tape and Reel	R-8	
AD8221ARZ-RL	-40°C to +85°C	-40°C to +125°C	8-Lead SOIC_N, 13" Tape and Reel	R-8	
AD8221ARM	-40°C to +85°C	-40°C to +125°C	8-Lead MSOP	RM-8	JLA
AD8221ARM-REEL	-40°C to +85°C	-40°C to +125°C	8-Lead MSOP, 13" Tape and Reel	RM-8	JLA
AD8221ARM REEL7	-40°C to +85°C	-40°C to +125°C	8-Lead MSOP, 7" Tape and Reel	RM-8	JLA
AD8221ARMZ	-40°C to +85°C	-40°C to +125°C	8-Lead MSOP	RM-8	JLA#
AD8221ARMZ-R7	-40°C to +85°C	-40°C to +125°C	8-Lead MSOP, 7" Tape and Reel	RM-8	JLA#
AD8221ARMZ-RL	-40°C to +85°C	-40°C to +125°C	8-Lead MSOP, 13" Tape and Reel	RM-8	JLA#
AD8221BR	-40°C to +85°C	-40°C to +125°C	8-Lead SOIC_N	R-8	
AD8221BR-REEL	-40°C to +85°C	-40°C to +125°C	8-Lead SOIC_N, 13" Tape and Reel	R-8	
AD8221BR-REEL7	-40°C to +85°C	-40°C to +125°C	8-Lead SOIC_N, 7" Tape and Reel	R-8	
AD8221BRZ	-40°C to +85°C	-40°C to +125°C	8-Lead SOIC_N	R-8	
AD8221BRZ-R7	-40°C to +85°C	-40°C to +125°C	8-Lead SOIC_N, 7" Tape and Reel	R-8	
AD8221BRZ-RL	-40°C to +85°C	-40°C to +125°C	8-Lead SOIC_N, 13" Tape and Reel	R-8	
AD8221AC-P7	-40°C to +85°C	-40°C to +125°C	Die		

<sup>1</sup> Z = RoHS Compliant Part, # denotes RoHS compliant product may be top or bottom marked.

<sup>2</sup> See Typical Performance Characteristics for expected operation from 85°C to 125°C.