

Keysight Technologies

LIV Test of Laser Diode Using the B2900A Series of SMUs

Application Note



Keysight B2901/02/11/12A Precision Source/Measure Unit

- B2901A Precision SMU, 1 ch, 100 fA resolution, 210 V, 3 A DC/10.5 A pulse
- B2902A Precision SMU, 2 ch, 100 fA resolution, 210 V, 3 A DC/10.5 A pulse
- B2911A Precision SMU, 1 ch, 10 fA resolution, 210 V, 3 A DC/10.5 A pulse
- B2912A Precision SMU, 2 ch, 10 fA resolution, 210 V, 3 A DC/10.5 A pulse

Introduction

The light-current-voltage (LIV) sweep test is a fundamental measurement to determine the operating characteristics of a laser diode (LD). In the LIV test, current applied to the laser diode is swept and the intensity of the resulting emitted light is measured using a photo detector (PD).

The Keysight Technologies, Inc. B2901/02/11/12A Precision Source/Measure Unit is a compact and cost-effective bench-top Source/Measure Unit (SMU) with the capability to output and measure both voltage and current. It covers currents from 10 fA to 3 A (DC)/10.5 A (pulse) and voltages from 100 nV to 210 V, which enables you to make a wide range of current versus voltage (IV) measurements more accurately and quickly than ever before. In addition, the B2900A Series of SMUs comes with an intuitive graphical user interface (GUI) and multiple free software control options that make it easy for you to begin making productive measurements immediately, allowing you to choose the solution that best fits your particular application. These features make the B2900A Series of SMUs the best solution for LIV testing of laser diodes.

The B2902A and B2912A have two SMU channels, and each channel possesses accurate IV measurement capabilities as well as the ability to supply either constant or swept voltage/current. The B2902A and B2912A excellent choices for laser diode LIV testing.

As shown in Figure 1, using the B2902A or B2912A, you can easily measure the LIV characteristics of laser diodes, including tests such as a laser forward voltage, threshold voltage and slope efficiency.

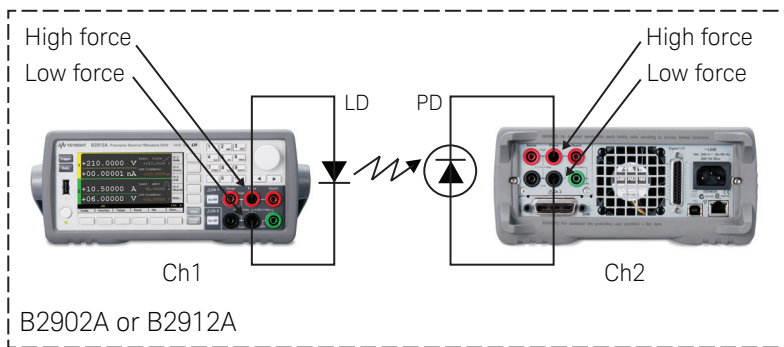

(a) Physical connection of the LIV test using the B2900A Series of SMUs.

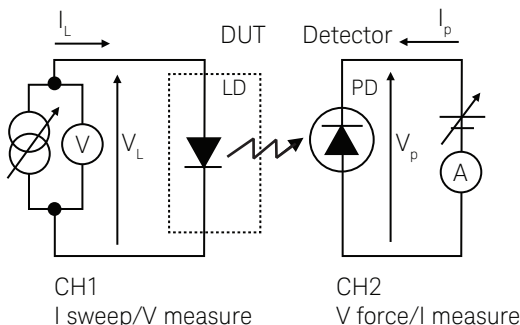

(b) Operating mode of each channel for the LIV test

Figure 1. Using the B2900A Series of SMUs to perform the LIV test of laser diodes

What is the B2900A Series of SMUs?

An SMU combines the capabilities of a current source, a voltage source, a current meter and a voltage meter along with the capability to switch easily between these various functions into a single instrument. This gives it the ability to evaluate the IV characteristics of devices across all four measurement quadrants without the need for any additional equipment. Besides being able to output and measure voltage or current very accurately, SMUs also possess a compliance feature that allows a limit to be placed on the voltage or current output to prevent device damage. The members of the B2900A Series of SMUs are single or dual channel SMU units that offer a wide range of IV measurement capability for a variety of two-terminal and three-terminal devices. They cover currents from 10 fA to 3 A (DC)/10.5 A (pulse) and voltages from 100 nV to 210 V. In addition to their DC operation mode, the B2900A Series of SMUs also has the ability to perform pulsed measurements in order to prevent device self-heating from distorting the measurement results.

1. Set the measurement condition and the compliance for Ch 1

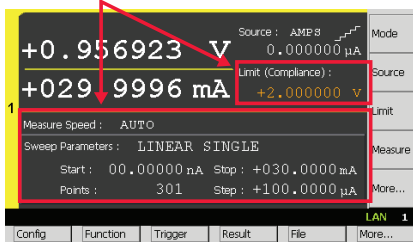

a. Single view for Ch1

2. Set the measurement condition and the compliance for Ch 2

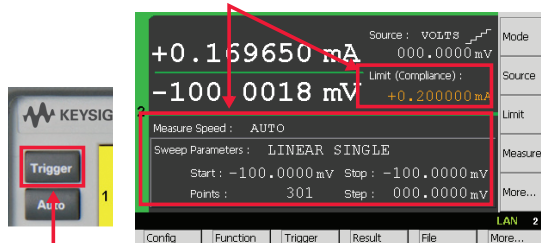

b. Single view for Ch2

3. Execute and see the result

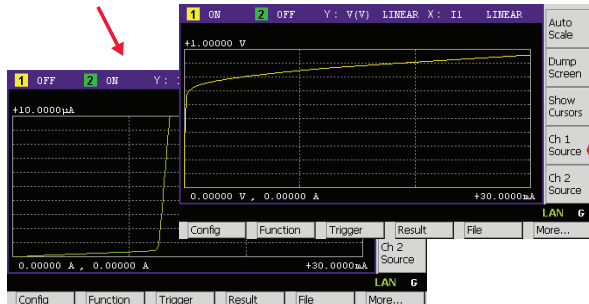

c. Graph view

Figure 2. The GUI of the B2900A Series of SMUs makes it easy to take a quick measurement and display the results

Quick and Easy IV Characterization

During routine device evaluation it is often desirable to make a quick measurement from the instrument's front panel without having to go through the time and trouble of writing a test program. To meet this need, the B2900A Series of SMUs has a resident GUI that makes it easy to perform a variety of tests and save measurement data without having to write any code.

The wide QVGA LCD display of the B2900A Series of SMUs supports an easy-to-use GUI that provides easy instrument control from the front panel. The GUI of the B2900A Series of SMUs has the following multiple viewing modes: Single View, Dual View, Graph View and Roll View (for viewing time domain measurements). Single View mode allows you to easily set up not only constant voltage and current measurements but also swept voltage and current measurements for a single SMU channel.

Dual View can perform similar functions for both channels simultaneously (for B2902A and B2912A). After measurement completion you can use the front panel GUI to graphically view measurement results such as IV curves using Graph View, and display a list of the measurement data using the Measure Result dialog window (please see Figure 2).

The B2900A Series of SMUs has a USB interface on the front panel so that a USB flash memory device can be used with the B2900A Series of SMUs to save and load measurement setups as well as to save measurement results. In addition, Graph View supports a Screen Dump function that enables you to save screen images (such as IV curves) to any attached USB flash memory device as JPEG files, making it easy to include graphical results in reports and presentations (please see Figure 3).

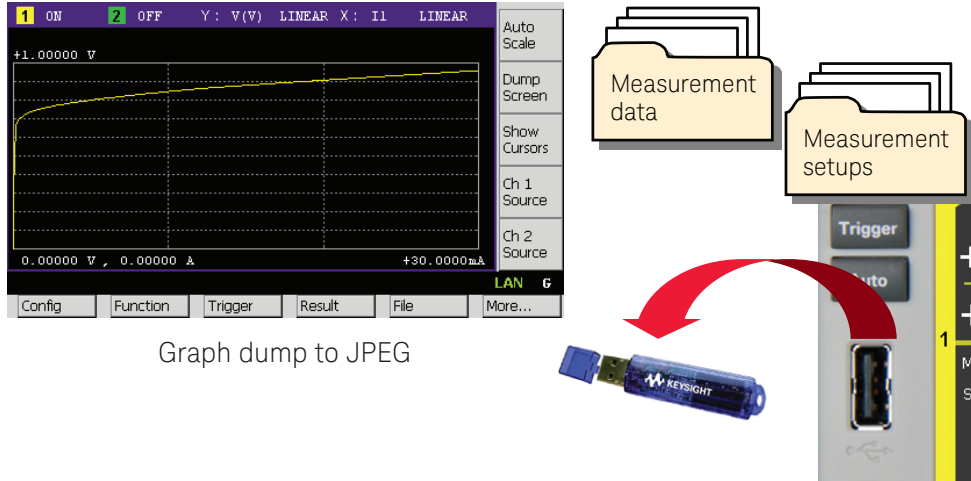

Figure 3. Measurement results and the measurement setups can be saved to any attached USB flash memory device

A Range of Free Software Control Options

In addition to its powerful and easy-to-use GUI, if you prefer PC-based instrument control, then the B2900A Series of SMUs comes with a range of free software control options to facilitate program development, allowing you to choose the solution that best fits your particular application.

BenchVue

The Keysight BenchVue software for the PC reinvents your bench testing by making it simple to connect and record results with your instruments without the need for programming. You can quickly and easily obtain results by viewing, logging and exporting measurement data and screen images with just a few mouse clicks. BenchVue provides a wide array of capabilities, depending on the chosen instrument application. These capabilities will vary according to the functionality of the instrument types and models, including the B2900A Series of SMUs, that are connected to the PC that is running the BenchVue software. See <http://www.keysight.com/find/benchvue> for more details.

Graphical Web Interface

The Keysight B2900A Graphical Web Interface provides functionality to allow access to the B2900A Series of SMUs over a LAN connection. The B2900A Series of SMUs is fully compliant with the LXI class C specification and contains a web server that provides a webpage with an interface to support the basic measurement functions of the B2900A. You can quickly and easily make measurements using a standard web browser by simply connecting the B2900A Series of SMUs to a PC using a LAN cable.

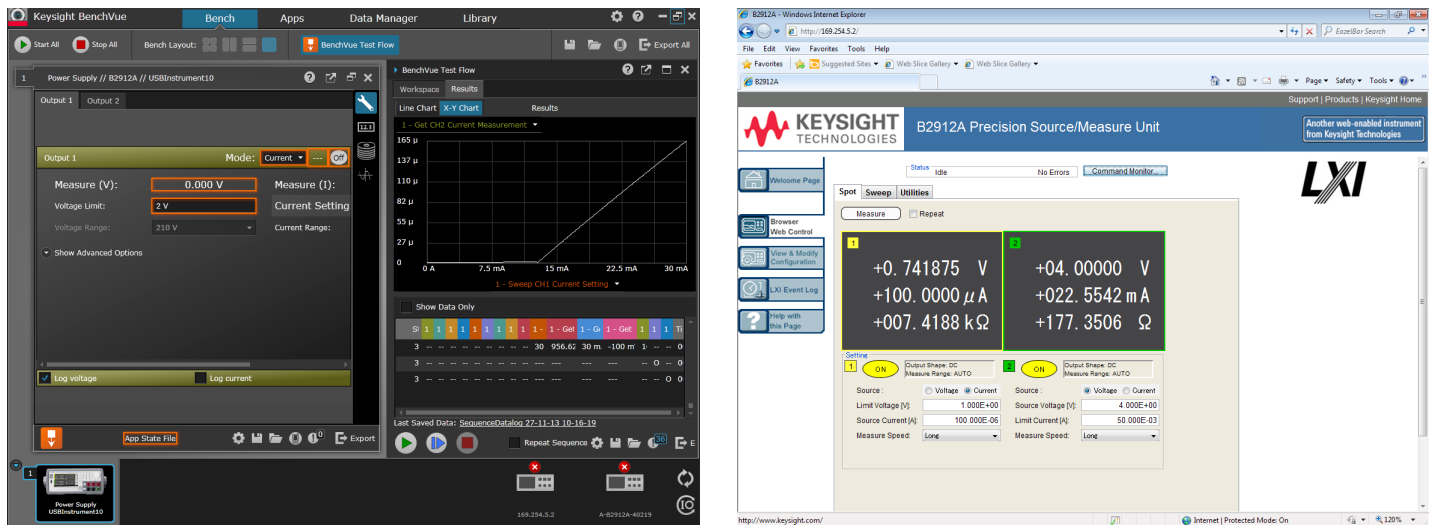

Figure 5. BenchVue and Graphical Web Interface

Quick I/V Measurement Software

The Keysight B2900A Quick I/V Measurement Software is a common software solution for the entire B2900 precision instrument family. It has powerful measurement capabilities to control the B2900A Series of SMUs over GPIB, USB or LAN connections (see Figure 6). You can download this PC-based software for free from <http://www.keysight.com/find/quickiv>. The Keysight B2900A Quick I/V Measurement Software also supports a variety of functions such as a sweep measurement, a sampling measurement, basic math functions, graphical display functions and the ability to save test results as CSV files.

- 1) Set the measurement condition for both channels
- 2) Perform the measurements
- 1) Set math functions if necessary
- 3) View the measurement results (Table)
- 3) View the measurement results (Graph)

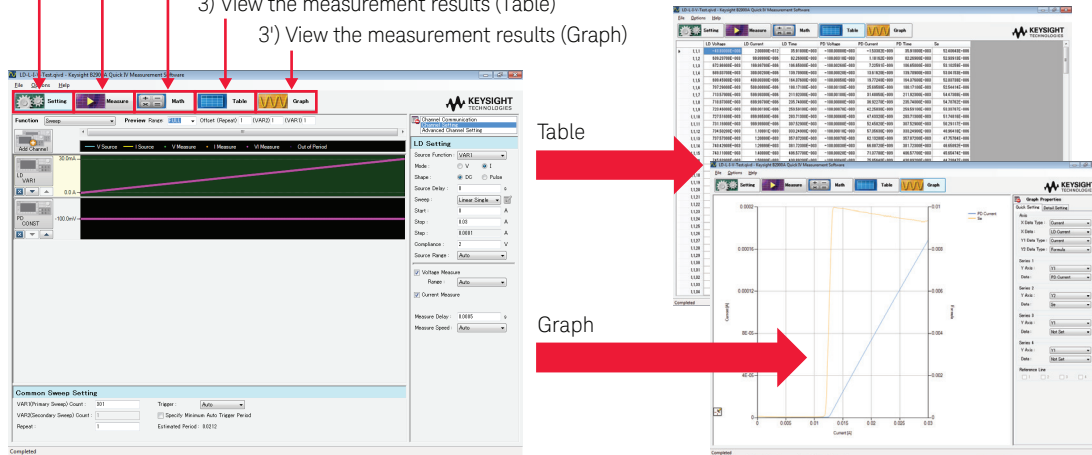

Figure 6. It is easy to make a quick measurement on a PC using the Keysight B2900A Quick I/V Measurement Software

EasyEXPERT Group+

The EasyEXPERT group+ software is the more powerful solution for detailed characterization and analysis of devices, circuits and materials. It supports efficient and repeatable characterization across the entire characterization process from measurement setup and execution to analysis and data management. EasyEXPERT group+ makes it easy to perform complex characterization with ready-to-use furnished measurements (application tests), and gives you the option of automatically storing every test condition and piece of measurement data in a unique built-in database (workspace), ensuring that valuable information is not lost and that measurements can be repeated at a later date. See <http://www.keysight.com/find/easyexpert> for more details.

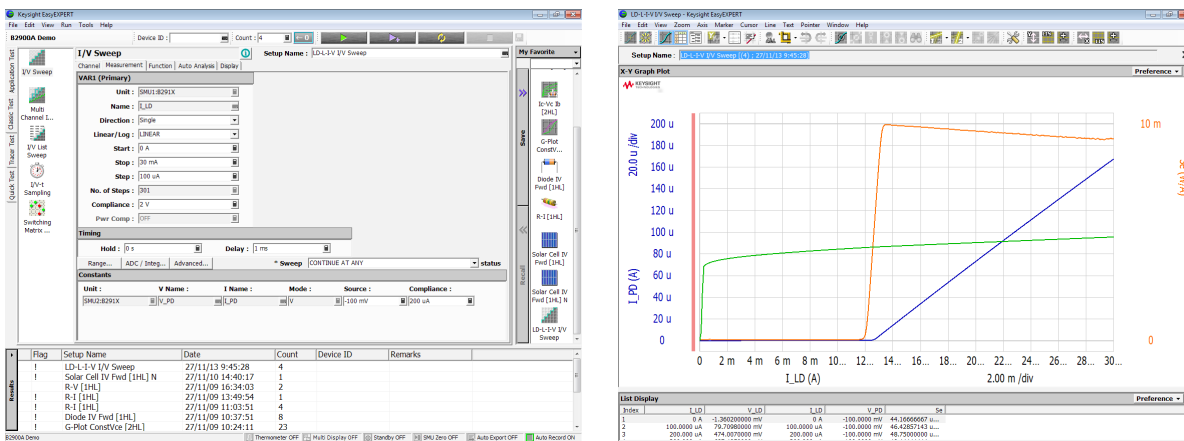

Figure 7. EasyEXPERT Group+ is a powerful solution for detailed characterization and analysis of devices, circuits and materials

Summary

The Keysight B2901/02/11/12A Precision Source/Measure Unit is the best solution for the LIV testing of laser diodes. Its wide current and voltage measurement ranges (from 10 fA/100 nV to 10.5 A/210 V) provide superior measurement performance and allow you to characterize devices more accurately and easily than ever before.

The easy-to-use GUI of the B2900A Series of SMUs has a variety of capabilities and features that make it easy to take measurements quickly and to save both the measurement setup conditions and data to USB-based flash memory devices.

In addition to being able to control the B2900A Series of SMUs remotely over GPIB, USB and LAN interfaces, Keysight offers multiple free software control options to facilitate program development if you prefer PC-based instrument control, allowing you to choose the solution that best fits your particular application.

For more detailed information on the various models of the B2900A Series of SMUs, please refer to the data sheet of the B2900A Series of SMUs (5990-7009EN).

The B2900A Series of SMUs enables you to quickly debug and accurately characterize a wide variety of devices using only a single bench-top SMU.

Keysight Precision Current-Voltage Analyzer Series and Power Device Analyzer Series

Keysight also offers a variety of analyzers which ensure accurate and efficient current-voltage measurements that give a clear insight into IV characteristics across a wide range of applications.

www.keysight.com/find/analyzer



B2900 Precision Instrument Family

The B2900 family contains products that perform both precision sourcing and precision measurement.

www.keysight.com/find/b2900a



From Hewlett-Packard through Agilent to Keysight
 For more than 75 years, we've been helping you unlock measurement insights.
 Our unique combination of hardware, software and people can help you reach
 your next breakthrough. **Unlocking measurement insights since 1939.**

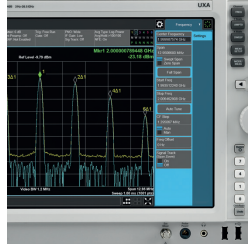
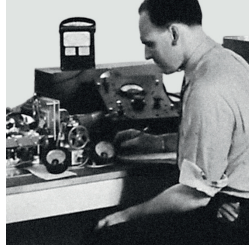

For more information on Keysight Technologies' products, applications or services, please contact your local Keysight office. The complete list is available at: www.keysight.com/find/contactus

Americas

Canada (877) 894 4414
 Brazil 55 11 3351 7010
 Mexico 001 800 254 2440
 United States (800) 829 4444

Asia Pacific

Australia 1 800 629 485
 China 800 810 0189
 Hong Kong 800 938 693
 India 1 800 11 2626
 Japan 0120 (421) 345
 Korea 080 769 0800
 Malaysia 1 800 888 848
 Singapore 1 800 375 8100
 Taiwan 0800 047 866
 Other AP Countries (65) 6375 8100

Europe & Middle East

Austria 0800 001122
 Belgium 0800 58580
 Finland 0800 523252
 France 0805 980333
 Germany 0800 6270999
 Ireland 1800 832700
 Israel 1 809 343051
 Italy 800 599100
 Luxembourg +32 800 58580
 Netherlands 0800 0233200
 Russia 8800 5009286
 Spain 800 000154
 Sweden 0200 882255
 Switzerland 0800 805353
 Opt. 1 (DE)
 Opt. 2 (FR)
 Opt. 3 (IT)
 United Kingdom 0800 0260637

For other unlisted countries:
www.keysight.com/find/contactus
 (BP-09-28-15)



www.keysight.com/go/quality
 Keysight Technologies, Inc.
 DEKRA Certified ISO 9001:2008
 Quality Management System

myKeysight

myKeysight
www.keysight.com/find/mykeysight
 A personalized view into the information most relevant to you.



Three-Year Warranty
www.keysight.com/find/ThreeYearWarranty
 Keysight's committed to superior product quality and lower total cost of ownership. Keysight is the only test and measurement company with three-year warranty standard on all instruments, worldwide. And, we provide a full one-year warranty on all accessories, calibration devices, systems and custom products.



Keysight Assurance Plans
www.keysight.com/find/AssurancePlans
 Up to ten years of protection and no budgetary surprises to ensure your instruments are operating to specification, so you can rely on accurate measurements.

Keysight Infoline

Keysight Infoline
www.keysight.com/find/service
 Keysight's insight to best in class information management. Free access to your Keysight equipment company reports and e-library.

Keysight Channel Partners
www.keysight.com/find/channelpartners
 Get the best of both worlds: Keysight's measurement expertise and product breadth, combined with channel partner convenience.

www.keysight.com/find/precisionSMU