

AUIPS1041(L)(R)/AUIPS1042G

SINGLE/DUAL CHANNEL INTELLIGENT POWER LOW SIDE SWITCH

Features

- Over temperature shutdown
- Over current shutdown
- Active clamp
- Low current & logic level input
- ESD protection
- Optimized Turn On/Off for EMI
- Diagnostic on the input current

Description

The AUIPS1041(L)(R) and AUIPS1042G are three terminal Intelligent Power Switches (IPS) featuring low side MOSFETs with over-current, over-temperature, ESD protection and drain to source active clamp. The AUIPS1042G is a dual channel device while the AUIPS1041 is a single channel. These devices offer protections and the high reliability required in harsh environments. Each switch provides efficient protection by turning OFF the power MOSFET when the temperature exceeds 165°C or when the drain current reaches 4.5A. The device restarts once the input is cycled. A serial resistance connected to the input provides the diagnostic. The avalanche capability is significantly enhanced by the active clamp and covers most inductive load demagnetizations.

Product Summary

Rds(on)	100mΩ (max.)
Vclamp	39V
Ishutdown	4.5A (typ.)

Packages

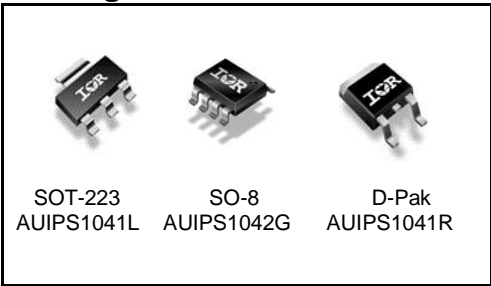

Typical Connection

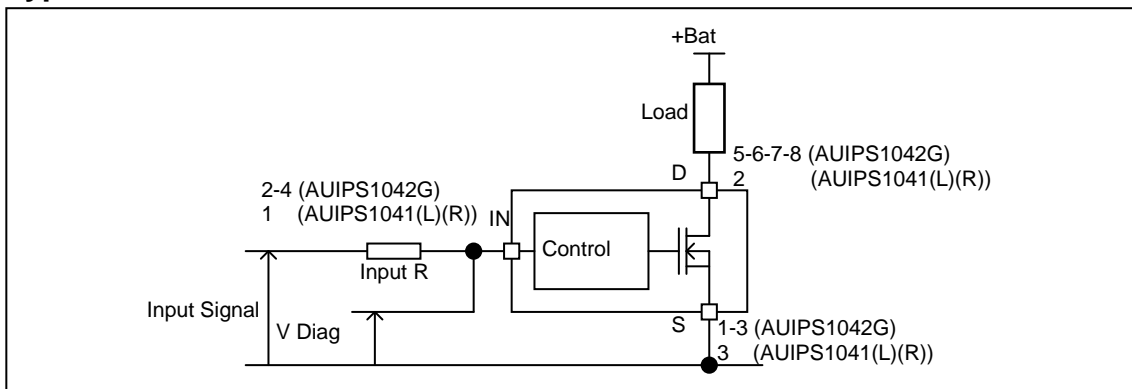

Qualification Information†

Qualification Level		Automotive (per AEC-Q100††)
		Comments: This family of ICs has passed an Automotive qualification. IR's Industrial and Consumer qualification level is granted by extension of the higher Automotive level.
Moisture Sensitivity Level		DPAK-3L MSL1, 260°C (per IPC/JEDEC J-STD-020)
		SOT223-3L MSL2, 260°C (per IPC/JEDEC J-STD-020)
		8L-SOICN MSL2, 260°C (per IPC/JEDEC J-STD-020)
ESD	Machine Model	Class M4 (+/-450V) (per AEC-Q100-003)
	Human Body Model	Class H2 (+/-2500V) (per AEC-Q100-002)
	Charged Device Model	Class C4 (+/-1000V) (per AEC-Q100-011)
IC Latch-Up Test		Class II, Level A (per AEC-Q100-004)
RoHS Compliant		Yes

† Qualification standards can be found at International Rectifier's web site <http://www.irf.com/>

†† Exceptions to AEC-Q100 requirements are noted in the qualification report.

Absolute Maximum Ratings

Absolute maximum ratings indicate sustained limits beyond which damage to the device may occur. (T_j= -40°C..150°C, V_{cc}=6..36V unless otherwise specified).

Symbol	Parameter	Min.	Max.	Units
V _{ds}	Maximum drain to source voltage	-0.3	36	V
V _{ds cont}	Maximum continuous drain to source voltage	-	28	V
V _{in}	Maximum input voltage	-0.3	6	V
I _{sd cont.}	Max diode continuous current (limited by thermal dissipation)	—	1.5	A
P _d	Maximum power dissipation (internally limited by thermal protection)			
	R _{th} =60°C/W AUIPS1041L 1" sqr. Footprint R _{th} =100°C/W AUIPS1042G std. footprint		2 1.25	W
T _{j max.}	Max. storage & operating temperature junction temperature	-40	150	°C

Thermal Characteristics

Symbol	Parameter	Typ.	Max.	Units
R _{th1}	Thermal resistance junction to ambient AUIPS1041L SOT-223 std. footprint	100	—	°C/W
R _{th2}	Thermal resistance junction to ambient AUIPS1041L SOT-223 1" sqr. Footprint	60	—	
R _{th1}	Thermal resistance junction to ambient AUIPS1041R D-Pak std. footprint	70	—	
R _{th2}	Thermal resistance junction to case AUIPS1041R D-Pak	6	—	
R _{th1}	Thermal resistance junction to ambient AUIPS1042G SO-8 std. Footprint 1 die active	100	—	
R _{th1}	Thermal resistance junction to ambient AUIPS1042G SO-8 std. footprint 2 die active	130	—	

Recommended Operating Conditions

These values are given for a quick design. For operation outside these conditions, please consult the application notes.

Symbol	Parameter	Min.	Max.	Units
V _{IH}	High level input voltage	4.5	5.5	V
V _{IL}	Low level input voltage	0	0.5	
I _{ds}	Continuous drain current, T _{ambient} =85°C, T _j =125°C, V _{in} =5V R _{th} =60°C/W AUIPS1041L 1" sqr. Footprint	—	1.95	A
	Continuous drain current, T _{ambient} =85°C, T _j =125°C, V _{in} =5V R _{th} =50°C/W AUIPS1041R 1" sqr. Footprint	—	2.2	
	Continuous drain current, T _{ambient} =85°C, T _j =125°C, V _{in} =5V R _{th} =100°C/W AUIPS1042G 1" sqr. Footprint - 1 die active	—	1.5	
	Continuous drain current, T _{ambient} =85°C, T _j =125°C, V _{in} =5V R _{th} =130°C/W AUIPS1042G 1" sqr. Footprint - 2 die active	—	0.7	
R _{in}	Recommended resistor in series with IN pin to generate a diagnostic	0.5	10	kΩ
Max L	Max. recommended load inductance (including line inductance) (1)	—	20	μH
Max. F	Max. frequency	—	2000	Hz
Max. t rise	Max. input rising time	—	1	μs

(1) Higher inductance is possible if maximum load current is limited - see figure 11

Static Electrical Characteristics

T_J = -40..150°C, V_{CC} = 6..28V (unless otherwise specified), typical value are given for T_J = 25°C

Symbol	Parameter	Min.	Typ.	Max.	Units	Test Conditions
R _{ds(on)}	ON state resistance T _J = 25°C	—	80	100	mΩ	V _{in} = 5V, I _{ds} = 3A
	ON state resistance T _J = 150°C	—	135	175		
I _{dss1}	Drain to source leakage current	—	0.1	2	μA	V _{CC} = 14V, T _J = 25°C
I _{dss2}	Drain to source leakage current	—	0.2	4		V _{CC} = 28V, T _J = 25°C
V _{clamp1}	Drain to source clamp voltage 1	36	38	—	V	I _d = 10mA
V _{clamp2}	Drain to source clamp voltage 2	—	39	42		I _d = 1A
V _{in clamp}	IN to source pin clamp voltage	5.5	6.5	7.5		I _{in} = 1mA
V _{th}	Input threshold voltage	—	1.7	—		I _d = 10mA

Switching Electrical Characteristics

V_{CC} = 14V, Resistive load = 5Ω, R_{input} = 0Ω, V_{in} = 5V, T_J = 25°C

Symbol	Parameter	Min.	Typ.	Max.	Units	Test Conditions
T _{don}	Turn-on delay time to 20%	2	7	15	μs	See figure 2
T _r	Rise time 20% to 80%	2	7	20		
T _{doff}	Turn-off delay time to 80%	15	40	150		
T _f	Fall time 80% to 20%	4	10	20		
E _{on} + E _{off}	Turn on and off energy	—	0.2	—	mJ	

Protection Characteristics

T_J = -40..150°C, V_{CC} = 6..28V (unless otherwise specified), typical value are given for T_J = 25°C

Symbol	Parameter	Min.	Typ.	Max.	Units	Test Conditions
T _{sd}	Over temperature threshold	150(2)	165	—	°C	See figure 1
I _{sd}	Over current threshold	2.7	4.5	6	A	See figure 1
OV	Over voltage protection (not active when the device is ON)	34	37	—	V	
V _{reset}	IN protection reset threshold	—	1.7	—	V	
T _{reset}	Time to reset protection	15(2)	50	200	μs	V _{in} = 0V, T _J = 25°C

(2) Guaranteed by design

Diagnostic

T_J = -40..150°C, V_{CC} = 6..28V (unless otherwise specified), typical value are given for T_J = 25°C

Symbol	Parameter	Min.	Typ.	Max.	Units	Test Conditions
I _{in, on}	ON state IN positive current	10	32	80	μA	V _{in} = 5V
I _{in, off}	OFF state IN positive current (after protection latched)	120	230	350		V _{in} = 5V

Lead Assignments

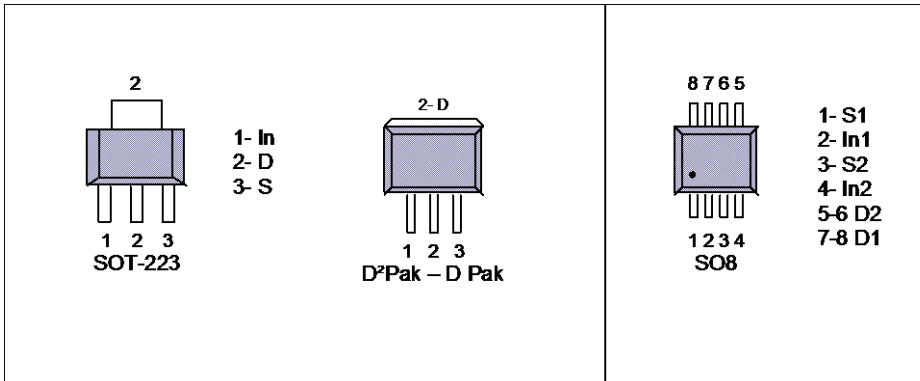

Functional Block Diagram

All values are typical

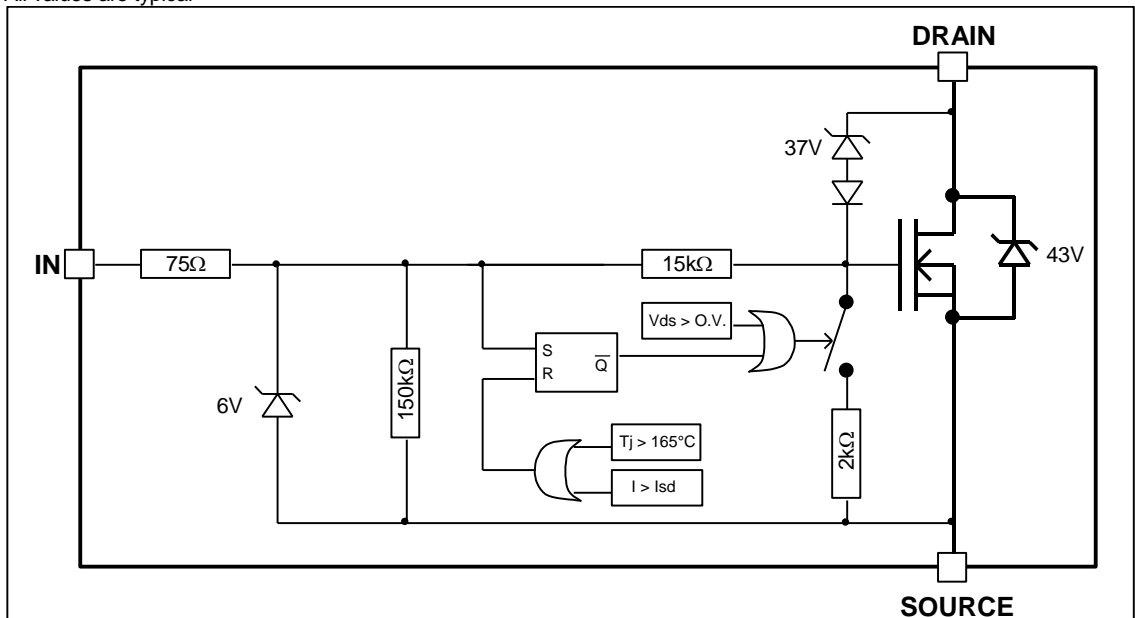

All curves are typical values. Operating in the shaded area is not recommended.

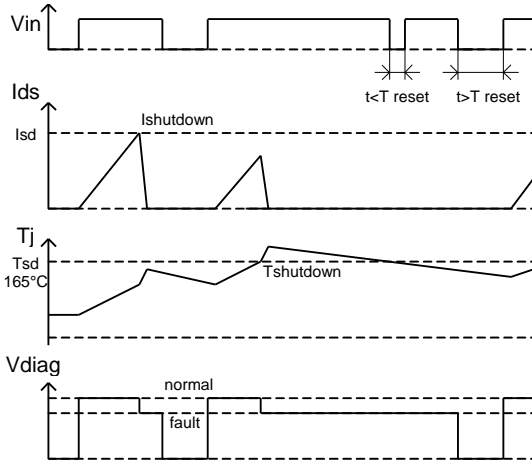

Figure 1 – Timing diagram

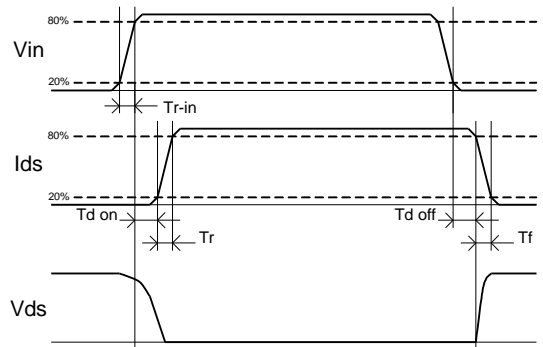

Figure 2 – IN rise time & switching definitions

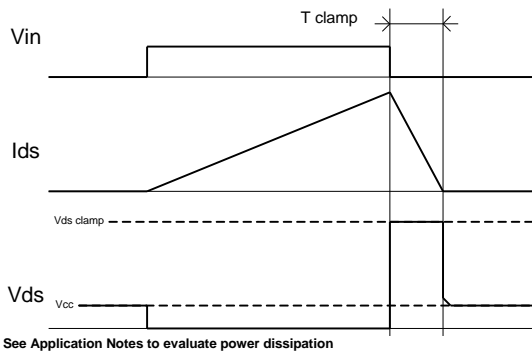

Figure 3 – Active clamp waveforms

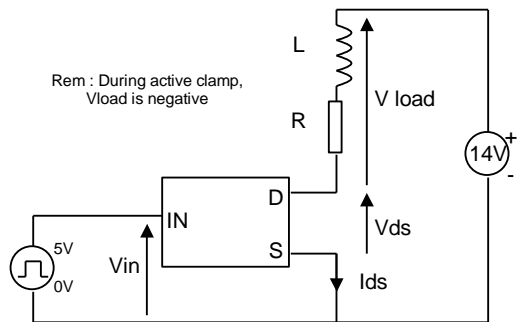

Figure 4 – Active clamp test circuit

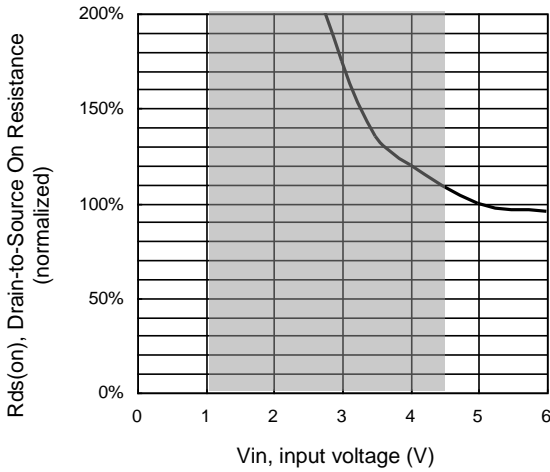

Figure 5 – Normalized Rds(on) (%) Vs Input voltage (V)

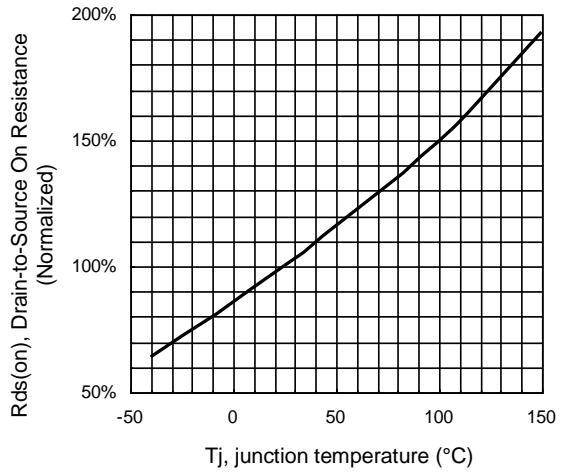

Figure 6 - Normalized Rds(on) (%) Vs Tj (°C)

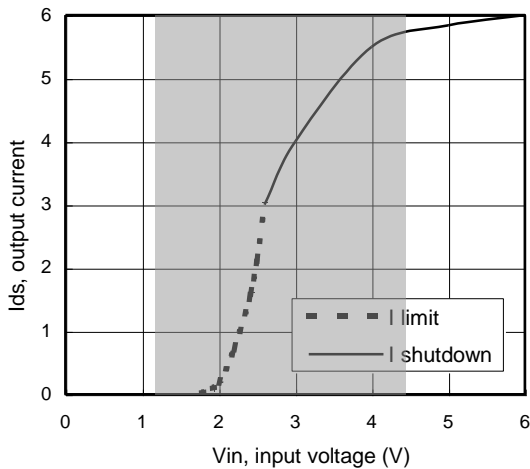

Figure 7 – Current limitation and current shutdown Vs Input voltage (V)

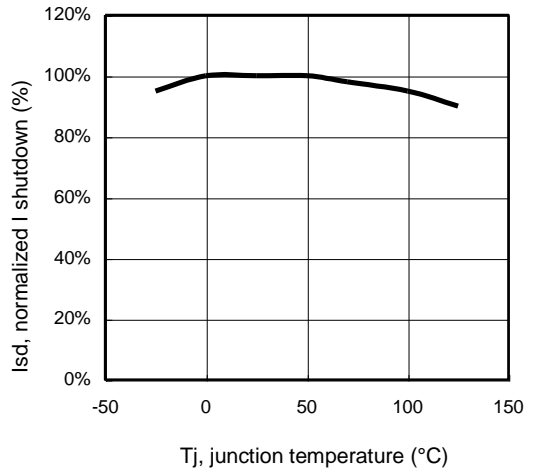

Figure 8 – Normalized I shutdown (%) Vs junction temperature (°C)

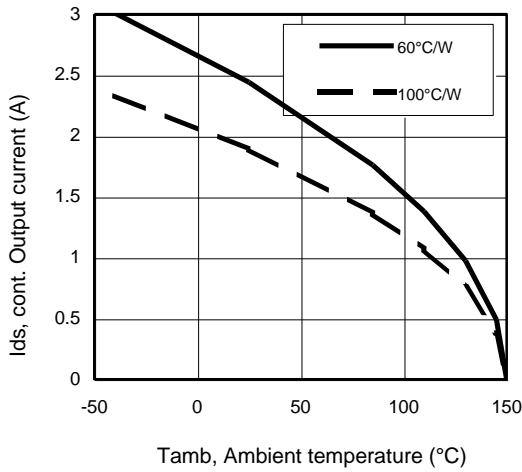

Figure 9 – Max. continuous output current (A) Vs Ambient temperature (°C)

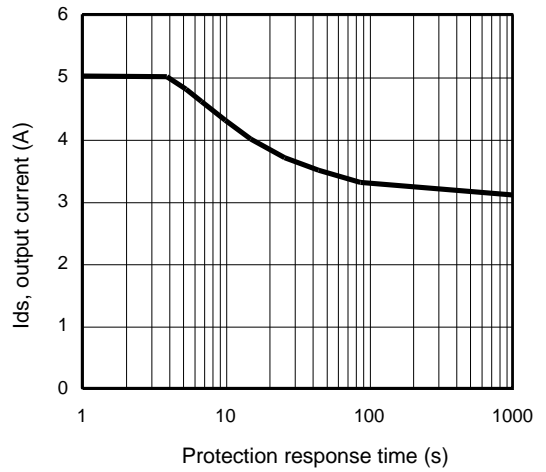

Figure 10 – Ids (A) Vs over temperature protection response time (s) / IPS1041L

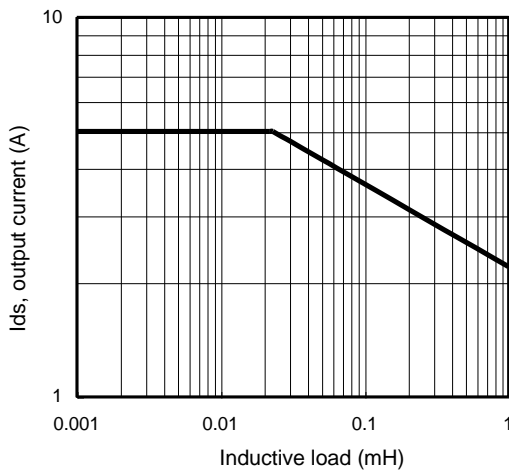

Figure 11 – Max. output current (A) Vs Inductive load (mH)

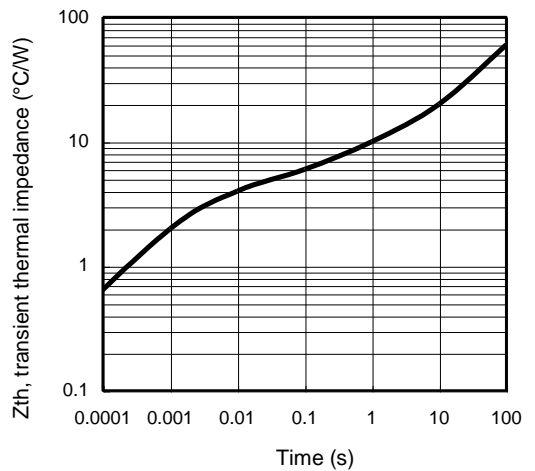

Figure 12 – Transient thermal impedance (°C/W) Vs time (s)

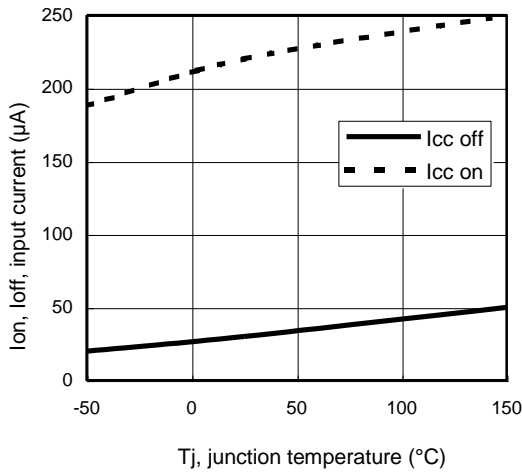

Figure 13 – Input current (µA) On and Off Vs junction temperature (°C)

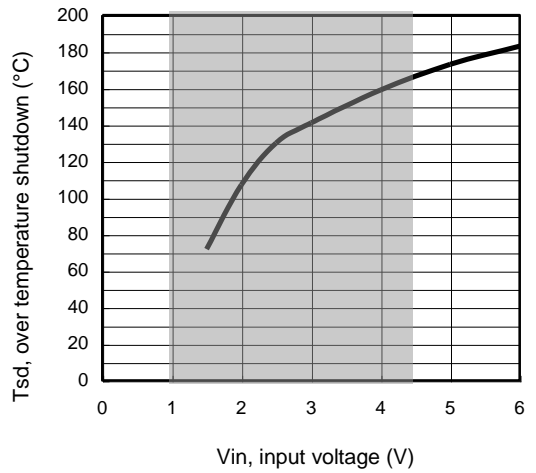
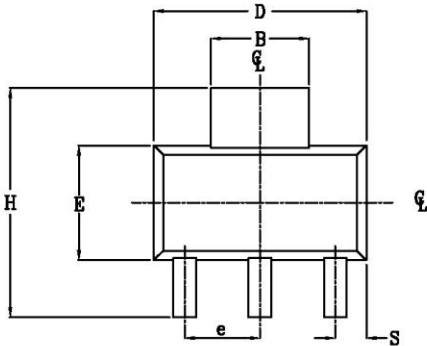
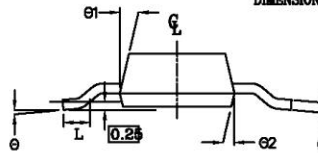
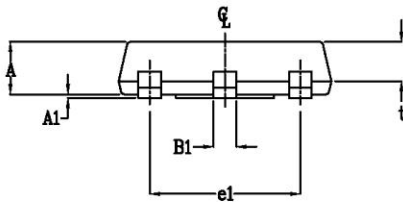

Figure 14 – Over temperature shutdown (°C) Vs input voltage (V)

Case Outline - SOT-223 - Automotive Q100 PbF MSL2 qualified



POS	MILLIMETERS		INCHES	
	MAX	MIN	MAX	MIN
A	1.70	1.50	.067	.060
A1	0.10	0.02	.004	.0008
B	3.15	2.95	.124	.116
B1	0.85	0.65	.033	.026
C	0.35	0.25	.014	.010
D	6.70	6.30	.264	.248
e	2.30 NOM		.0905 NOM	
e1	4.60 NOM		.181 NOM	
E	3.70	3.30	.146	.130
H	7.30	6.70	.287	.264
S	1.05	0.85	.041	.033
t	1.30	1.10	.051	.043
Ø	10° MAX		10° MAX	
Ø1	16°	10°	16°	10°
Ø2	16°	10°	16°	10°
L	0.75 MIN		0.0295 MIN	



NOTE:
 1. PACKAGE OUTLINE EXCLUSIVE OF ANY MOLD FLASHES DIMENSION.
 2. PACKAGE OUTLINE EXCLUSIVE OF BURR DIMENSION.

Leads and drain are plated with 100% Sn

Tape & Reel - SOT-223

Dimensions are shown in millimeters (inches)

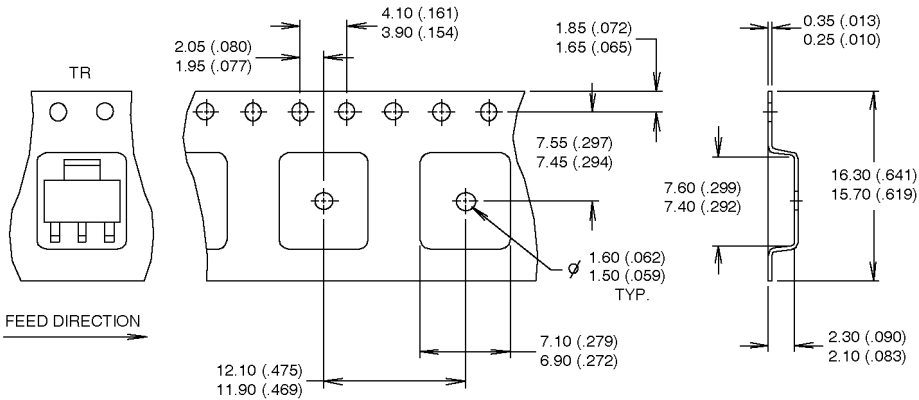

NOTES :

1. CONTROLLING DIMENSION: MILLIMETER.
2. OUTLINE CONFORMS TO EIA-481 & EIA-541.
3. EACH $\varnothing 330.00$ (13.00) REEL CONTAINS 2,500 DEVICES.



NOTES :

1. OUTLINE CONFORMS TO EIA-418-1.
2. CONTROLLING DIMENSION: MILLIMETER.
- ④ DIMENSION MEASURED @ HUB.
- ④ INCLUDES FLANGE DISTORTION @ OUTER EDGE.

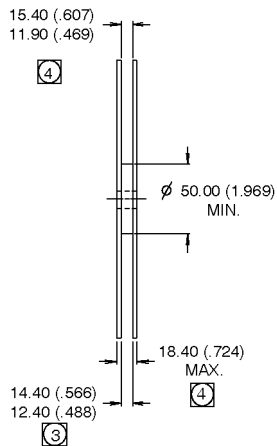

Case Outline - SO-8 - Automotive Q100 PbF MSL2 qualified

Dimensions are shown in millimeters (inches)

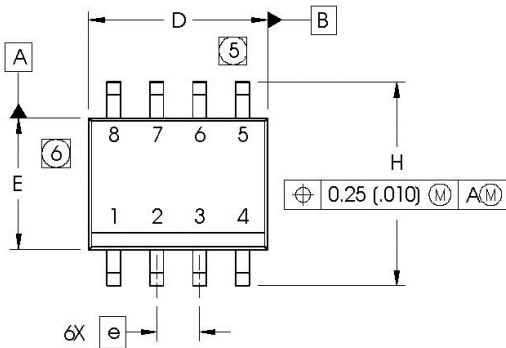

DIM	INCHES		MILLIMETERS	
	MIN	MAX	MIN	MAX
A	.0532	.0688	1.35	1.75
AI	.0040	.0098	0.10	0.25
b	.013	.020	0.33	0.51
c	.0075	.0098	0.19	0.25
D	.189	.1968	4.80	5.00
E	.1497	.1574	3.80	4.00
e	.050 BASIC		1.27 BASIC	
e1	.025 BASIC		0.635 BASIC	
H	.2284	.2440	5.80	6.20
K	.0099	.0196	0.25	0.50
L	.016	.050	0.40	1.27
y	0°	8°	0°	8°

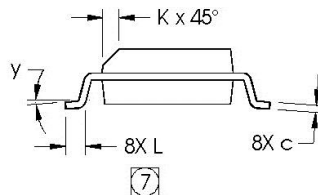
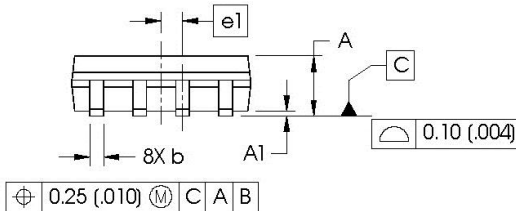

NOTES:

1. DIMENSIONING & TOLERANCING PER ASME Y14.5M-1994.
2. CONTROLLING DIMENSION: MILLIMETER
3. DIMENSIONS ARE SHOWN IN MILLIMETERS (INCHES).
4. OUTLINE CONFORMS TO JEDEC OUTLINE MS-012AA.
- ⑤ DIMENSION DOES NOT INCLUDE MOLD PROTRUSIONS. MOLD PROTRUSIONS NOT TO EXCEED 0.15 (.006).
- ⑥ DIMENSION DOES NOT INCLUDE MOLD PROTRUSIONS. MOLD PROTRUSIONS NOT TO EXCEED 0.25 (.010).
- ⑦ DIMENSION IS THE LENGTH OF LEAD FOR SOLDERING TO A SUBSTRATE.

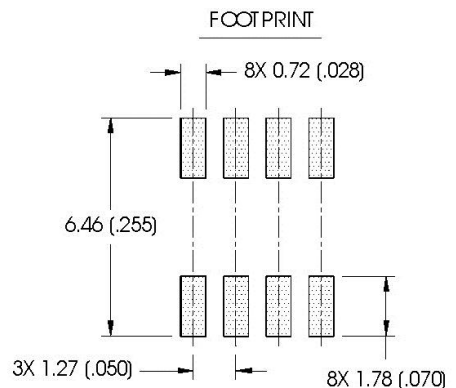

Leads and drain are plated with 100% Sn

Tape & Reel - SO-8

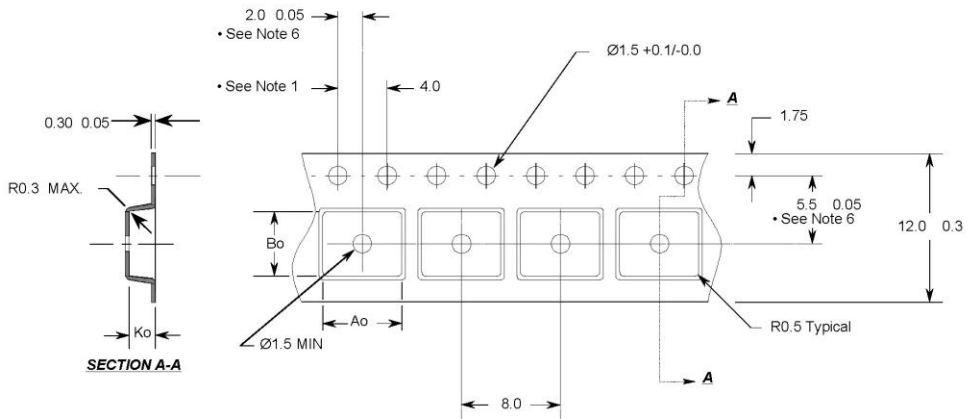

Notes:

1. 10 sprocket hole pitch cumulative tolerance 0.2
2. Camber not to exceed 1mm in 100mm
3. Material: Black Conductive Advantek Polystyrene
4. Ao and Bo measured on a plane 0.3mm above the bottom of the pocket
5. Ko measured from a plane on the inside bottom of the pocket to the top surface of the carrier.
6. Pocket position relative to sprocket hole measured as true position of pocket, not pocket hole.

Ao = 6.4 mm
 Bo = 5.2 mm
 Ko = 2.1 mm

- All Dimensions in Millimeters -

Case Outline – D-Pak - Automotive Q100 PbF MSL1 qualified

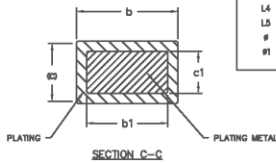
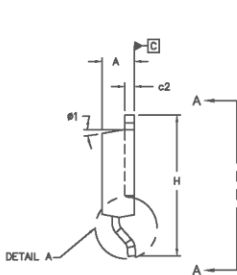
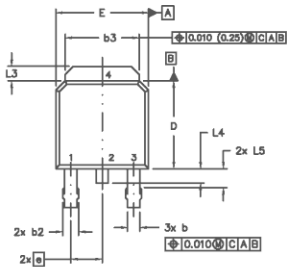
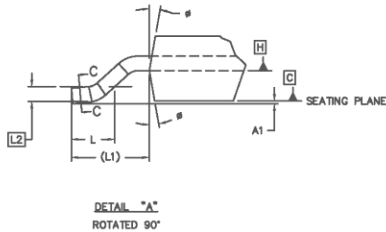
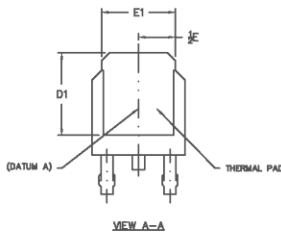

SYMBOL	DIMENSIONS				NOTES
	MILLIMETERS		INCHES		
	MIN.	MAX.	MIN.	MAX.	
A	2.18	2.30	.086	.094	
A1		0.13		.005	
b	0.64	0.69	.025	.035	5
b1	0.64	0.70	.025	0.031	5
b2	0.76	1.14	.030	.045	
b3	4.95	5.48	.195	.215	
c	0.48	0.61	.018	.024	5
c1	0.41	0.56	.016	.022	5
c2	.046	0.89	.018	.035	5
D	5.97	6.22	.235	.245	6
D1	5.21	-	.205	-	4
E	6.35	6.73	.250	.265	6
E1	4.32	-	.170	-	4
e	3.28		.090 BSC		
H	9.40	10.41	.370	.410	
L	1.40	1.78	.055	.070	
L1	2.74 REF.		.108 REF.		
L2	0.51 BSC		.020 BSC		
L3	0.69	1.27	.035	.050	
L4		1.62		.040	
L5	1.14	1.52	.045	.060	
#	0"	10"	0"	10"	3
#1	0"	19"	0"	19"	

NOTES:

- 1.0 DIMENSIONING AND TOLERANCING PER ASME Y14.5 M- 1994.
- 2.0 DIMENSIONS ARE SHOWN IN INCHES [MILLIMETERS].
- 3.0 LEAD DIMENSION UNCONTROLLED IN L5.
- 4.0 DIMENSION D1 AND E1 ESTABLISH A MINIMUM MOUNTING SURFACE FOR THERMAL PAD.
- 5.0 SECTION C-C DIMENSIONS APPLY TO THE FLAT SECTION OF THE LEAD BETWEEN .005 [0.127] AND .010 [0.2540] FROM THE LEAD TIP.
- 6.0 DIMENSION D & E DO NOT INCLUDE MOLD FLASH. MOLD FLASH SHALL NOT EXCEED .005" (0.127) PER SIDE. THESE DIMENSIONS ARE MEASURED AT THE OUTERMOST EXTREMES OF THE PLASTIC BODY.
- 7.0 OUTLINE CONFORMS TO JEDEC OUTLINE TO-252AA.
- 8.0 LEADS AND DRAIN ARE PLATED WITH 100% Sn

Tape & Reel - D-Pak

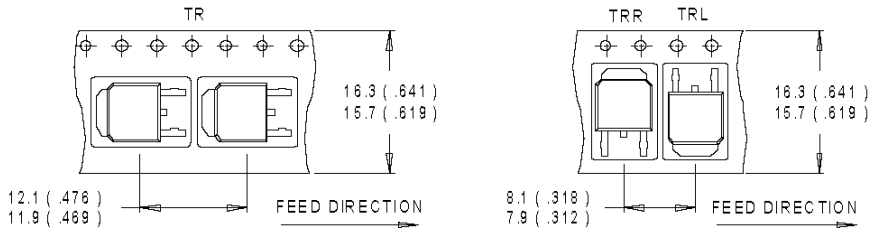

NOTES :

1. CONTROLLING DIMENSION : MILLIMETER.
2. ALL DIMENSIONS ARE SH OWN IN MILLIMETERS (INCHES).
3. OUTLINE CONFORMS TO EIA-481 & EIA-541.

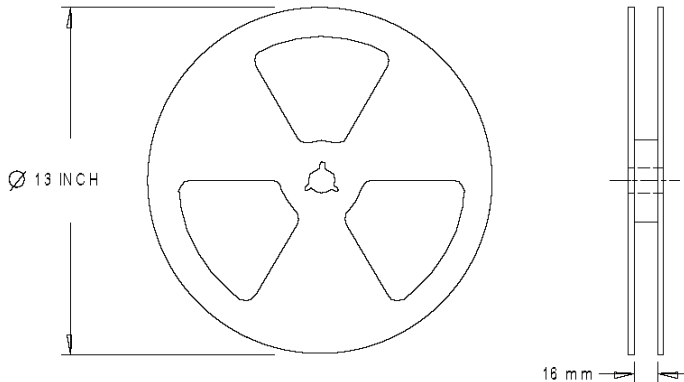

NOTES :

1. OUTLINE CONFORMS TO EIA-481.

Dimensions are shown in millimeters (inches)

Part Marking Information

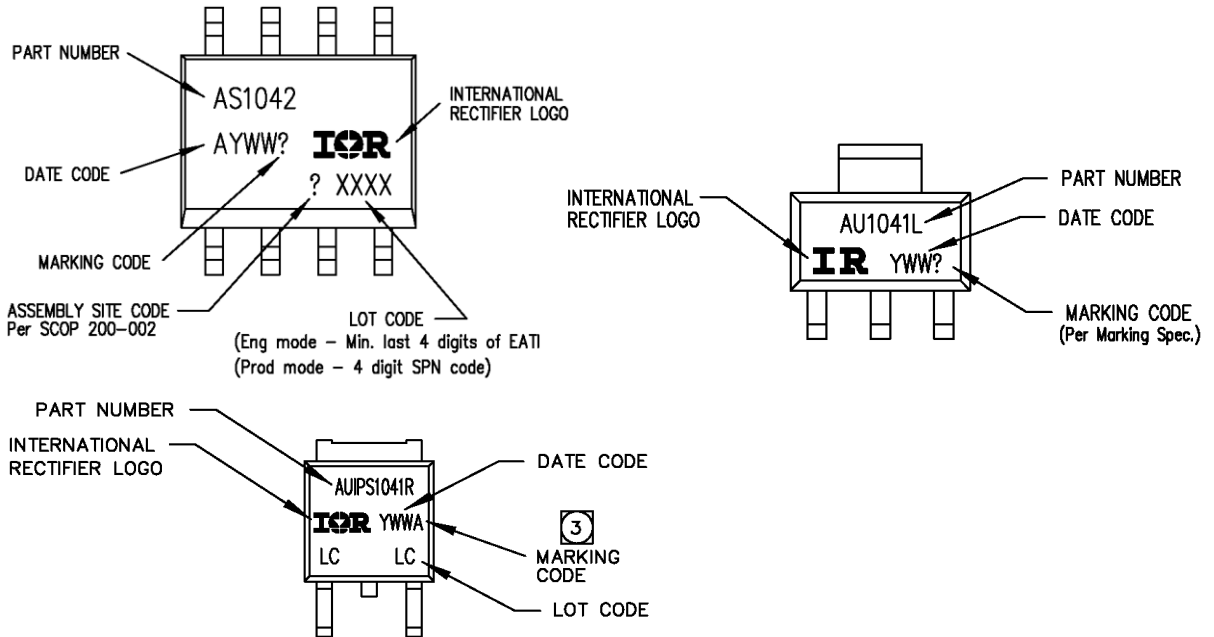

Ordering Information

Base Part Number	Package Type	Standard Pack		Complete Part Number
		Form	Quantity	
AUIPS1042	SOIC-8	Tube	95	AUIPS1042G
		Tape and reel	2500	AUIPS1042GTR
AUIPS1041	SOT-223	Tube	80	AUIPS1041L
		Tape and reel	2500	AUIPS1041LTR
AUIPS1041	D-Pak-5-Lead	Tube	75	AUIPS1041R
		Tape and reel	2000	AUIPS1041RTR
		Tape and reel left	3000	AUIPS1041RTRL
		Tape and reel right	3000	AUIPS1041RTRR

IMPORTANT NOTICE

Unless specifically designated for the automotive market, International Rectifier Corporation and its subsidiaries (IR) reserve the right to make corrections, modifications, enhancements, improvements, and other changes to its products and services at any time and to discontinue any product or services without notice. Part numbers designated with the "AU" prefix follow automotive industry and / or customer specific requirements with regards to product discontinuance and process change notification. All products are sold subject to IR's terms and conditions of sale supplied at the time of order acknowledgment.

IR warrants performance of its hardware products to the specifications applicable at the time of sale in accordance with IR's standard warranty. Testing and other quality control techniques are used to the extent IR deems necessary to support this warranty. Except where mandated by government requirements, testing of all parameters of each product is not necessarily performed.

IR assumes no liability for applications assistance or customer product design. Customers are responsible for their products and applications using IR components. To minimize the risks with customer products and applications, customers should provide adequate design and operating safeguards.

Reproduction of IR information in IR data books or data sheets is permissible only if reproduction is without alteration and is accompanied by all associated warranties, conditions, limitations, and notices. Reproduction of this information with alterations is an unfair and deceptive business practice. IR is not responsible or liable for such altered documentation. Information of third parties may be subject to additional restrictions.

Resale of IR products or serviced with statements different from or beyond the parameters stated by IR for that product or service voids all express and any implied warranties for the associated IR product or service and is an unfair and deceptive business practice. IR is not responsible or liable for any such statements.

IR products are not designed, intended, or authorized for use as components in systems intended for surgical implant into the body, or in other applications intended to support or sustain life, or in any other application in which the failure of the IR product could create a situation where personal injury or death may occur. Should Buyer purchase or use IR products for any such unintended or unauthorized application, Buyer shall indemnify and hold International Rectifier and its officers, employees, subsidiaries, affiliates, and distributors harmless against all claims, costs, damages, and expenses, and reasonable attorney fees arising out of, directly or indirectly, any claim of personal injury or death associated with such unintended or unauthorized use, even if such claim alleges that IR was negligent regarding the design or manufacture of the product.

IR products are neither designed nor intended for use in military/aerospace applications or environments unless the IR products are specifically designated by IR as military-grade or "enhanced plastic." Only products designated by IR as military-grade meet military specifications. Buyers acknowledge and agree that any such use of IR products which IR has not designated as military-grade is solely at the Buyer's risk, and that they are solely responsible for compliance with all legal and regulatory requirements in connection with such use.

IR products are neither designed nor intended for use in automotive applications or environments unless the specific IR products are designated by IR as compliant with ISO/TS 16949 requirements and bear a part number including the designation "AU". Buyers acknowledge and agree that, if they use any non-designated products in automotive applications, IR will not be responsible for any failure to meet such requirements.

For technical support, please contact IR's Technical Assistance Center
<http://www.irf.com/technical-info/>

WORLD HEADQUARTERS:

101 N Sepulveda Blvd., El Segundo, California 90245
Tel: (310) 252-7105

Revision History

Revision	Date	Notes/Changes
C1	November, 24 th , 2010	AU release
C2	December, 7 th 2010	Remove ESD section page 3
C3	December, 9 th 2010	Update qual page
C4	December, 14 th 2010	Update Tdon
D	February, 28 th 2011	Update Max rating
E	March, 14 th 2011	Update part marking
F	November, 14 th 2011	Update T&R SOT223
G	May 9th, 2012	Update component number for the SOT223 tube.