

Printview: PCB terminal strip; 4 solder pins/pole; 2-pole; pin spacing 10 mm / 0.394 in; with operating levers; without jumper slot - Item No.: 2716-102

WAGO® online catalog / eShop

PCB terminal strip; 4 solder pins/pole; 2-pole; pin spacing 10 mm / 0.394 in; with operating levers; without jumper slot

Item No.: 2716-102



PCB terminal strip; 4 solder pins/pole; 2-pole; pin spacing 10 mm / 0.394 in; with operating levers; without jumper slot

Marking

RoHS ✓
Compliant

Business data

Supplier	WAGO
Item no.	2716-102
GTIN / EAN	4045454739140
Content	1
Order amount	65
Customer item number	

Notes

High-current terminal strips with lever-actuated CAGE CLAMP® Tool-free opening and closing – fingers open/close levers
Several clamping units can be held open simultaneously – convenient for terminating multi-core cables
Four solder pins per contact point for high mechanical stability
600V UL for 12.5mm pin spacing
Pin and dimensions compatible to high-current, screw-type terminal blocks

Technical data

Miscellaneous

No. of poles	2
Pin Spacing	10 mm (0.394 in %)
Total number of connection points	2
Total number of potentials	2
Color	gray
Ratings according to 1	IEC/EN 60664-1

Technical data	
Overvoltage category EN 1	III
Pollution degree (1)	2
Rated voltage EN (1) [V]	320 [V]
Rated surge voltage (1) [kV]	4 [kV]
Nominal current [A]	76 [A]
Overvoltage category EN 2	II
Degree of pollution (2)	2
Rated voltage EN (2) [V]	630 [V]
Rated surge voltage (2) [kV]	4 [kV]
Nominal current (2) [A]	76 [A]
Overvoltage category EN 3	III
Degree of pollution (3)	3
Rated voltage EN (3) [V]	320 [V]
Rated surge voltage (3) [kV]	4 [kV]
Nominal current (3) [A]	76 [A]
Number of individual connection objects at the product	1
Connection technology (1)	CAGE CLAMP®
Solid sizes 1	1.5 ... 16 mm ² / 16 ... 6 AWG
Fine-stranded wires 1	1.5 ... 6 mm ² / 16 ... 6 AWG
Fine-stranded wires with insulated ferrule 1	1.5 ... 10 mm ² / ...
Fine-stranded wires with uninsulated ferrule 1	1.5 ... 10 mm ² / ...
Strip length 1	12 ... 13 mm / 0.47 ... 0.51 in
Conductor entry angle to the PCB 1 [°]	30 [°]
Solder pin arrangement	in-line solder pin
Solder pin length [mm]	4.5 [mm]
Solder pin width A [mm]	0.95 [mm]
Solder pin width B [mm]	1.2 [mm]
Tolerance of drilled hole [mm]	1.6(+ 0.1) [mm]
Material group	I
Insulating material	Polyamide 66 (PA 66)
Flammability rating per UL 94	V0
Limit temperature range	-60 C ... 105 C
Clamping spring material	Chrome-nickel spring steel (CrNi)
Contact material	Electrolytic copper (Ecu)

Printview: PCB terminal strip; 4 solder pins/pole; 2-pole; pin spacing 10 mm / 0.394 in; with operating levers; without jumper slot - Item No.: 2716-102

Technical data	
<i>Contact plating</i>	<i>tin-plated</i>
<i>Fire load [MJ]</i>	<i>0.301 [MJ]</i>
<i>Weight [g]</i>	<i>18.58 [g]</i>
<i>Width</i>	<i>21.5 mm / 0.846 in</i>
<i>Height</i>	<i>33.3 mm / 1.311 in</i>
<i>Height from the surface</i>	<i>28.8 mm / 1.134 in</i>
<i>Length</i>	<i>30 mm / 1.181 in</i>

Printview: PCB terminal strip; 4 solder pins/pole; 2-pole; pin spacing 10 mm / 0.394 in; with operating levers; without jumper slot - Item No.: 2716-102

Images & drawings

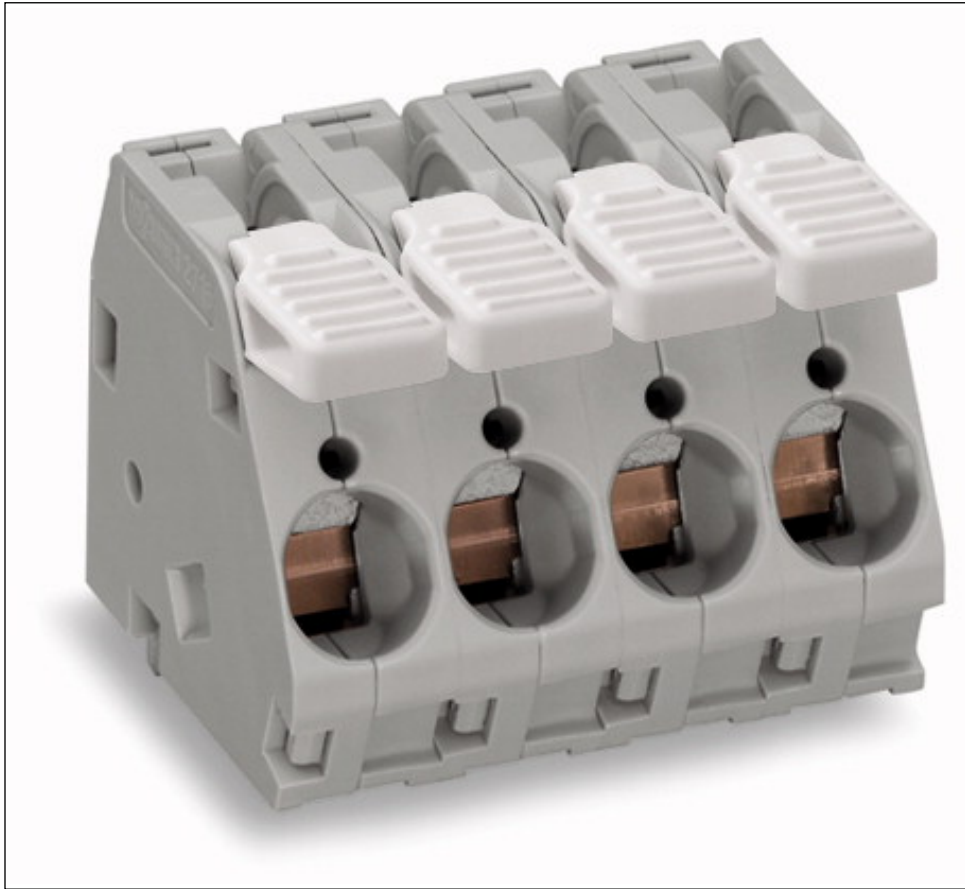

Printview: PCB terminal strip; 4 solder pins/pole; 2-pole; pin spacing 10 mm / 0.394 in; with operating levers; without jumper slot - Item No.: 2716-102

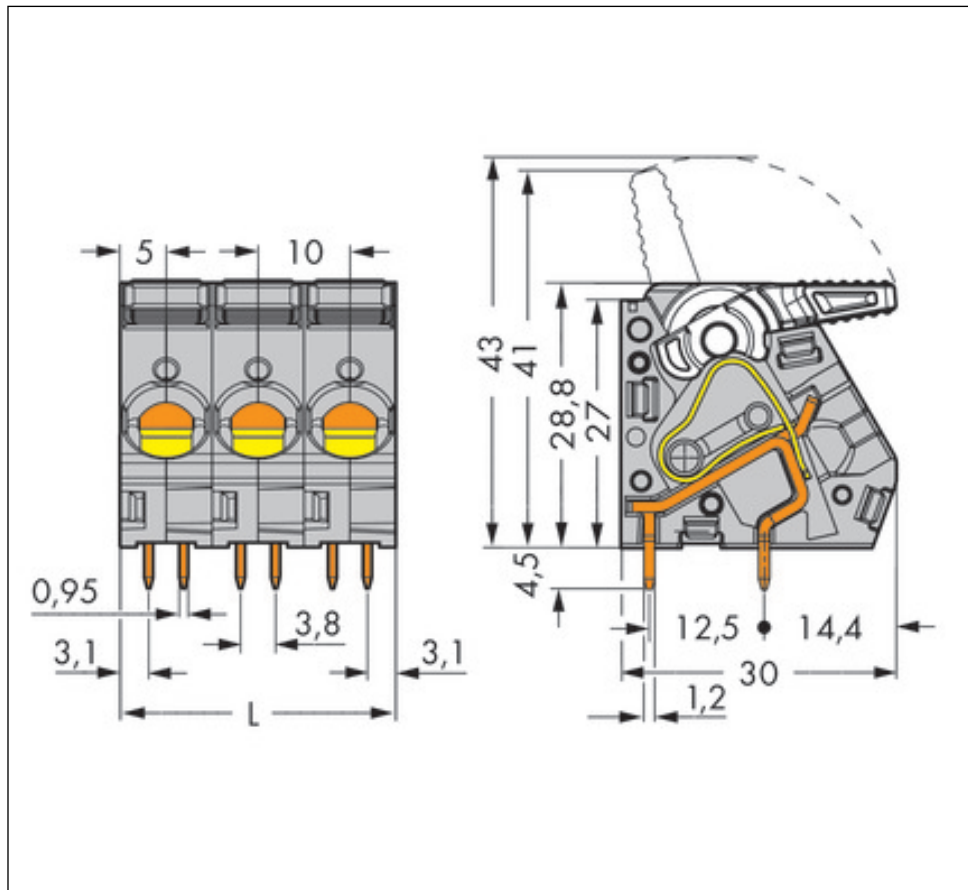

Address

WAGO Kontakttechnik GmbH & Co. KG

Hansastr. 27

32423 Minden

Telefon: 0571/887-0

Fax: 0571/887-169

<http://www.wago.com>

© WAGO Kontakttechnik GmbH & Co. KG

Technische Änderungen und Irrtümer vorbehalten.