

4-conductor fuse disconnect terminal block with pivoting fuse holder; for 5 x 20 mm miniature metric fuse; 12 ... 30 V; with blown fuse indication by led

Item No.: 2002-1811/1000-541

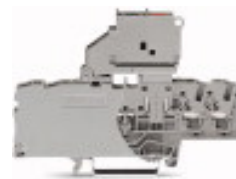

4-conductor fuse disconnect terminal block with pivoting fuse holder; for 5 x 20 mm miniature metric fuse; 12 ... 30 V; with blown fuse indication by led

Marking

RoHS ✓
Compliant

Business data

Supplier	WAGO
Item no.	2002-1811/1000-541
GTIN / EAN	4045454790073
Content	1
Order amount	50
Customer item number	

Notes

Safety information 1: Electrical ratings are given by the fuse and blown fuse indication.

Technical data

Miscellaneous

Total number of connection points	4
Total number of potentials	1
Color	gray
Ratings according to 1	IEC/EN 60947-7-3
Pollution degree (1)	3
Rated voltage EN (1) [V]	250 [V]
Rated surge voltage (1) [kV]	6 [kV]
Nominal current [A]	6.3 [A]

Technical data	
<i>Connection technology (1)</i>	<i>Push-in CAGE CLAMP®</i>
<i>Nominal cross section 1</i>	<i>2.5 mm²</i>
<i>Solid sizes 1</i>	<i>0.25 ... 4 mm² / 22 ... 12 AWG</i>
<i>solid, directly pluggable 1</i>	<i>0.75 ... 4 mm² / 18 ... 12 AWG</i>
<i>Fine-stranded wires 1</i>	<i>0.25 ... 4 mm² / 22 ... 12 AWG</i>
<i>min. fine-stranded with insulated ferrule, push-in terminati</i>	<i>0.75 mm² / 18 AWG</i>
<i>Strip length 1</i>	<i>10 ... 12 mm / 0.39 ... 0.47 in</i>
<i>Type of wiring</i>	<i>Front-entry wiring</i>
<i>Design</i>	<i>horizontal</i>
<i>Marking level</i>	<i>Center/Side marking</i>
<i>Insulating material</i>	<i>Polyamide 66 (PA 66)</i>
<i>Weight [g]</i>	<i>8.426 [g]</i>
<i>Width</i>	<i>6.2 mm / 0.244 in</i>
<i>Height from upper-edge of DIN-rail [mm]</i>	<i>57.2 [mm]</i>
<i>Height from upper-edge of DIN-rail</i>	<i>57.2 mm / 2.252 in</i>
<i>Length</i>	<i>87.5 mm / 3.445 in</i>
<i>Type of mounting</i>	<i>DIN 35 rail</i>
<i>Safety information 2</i>	<i>Leakage current in case of blown fuse: LED 2mA</i>

Images & drawings

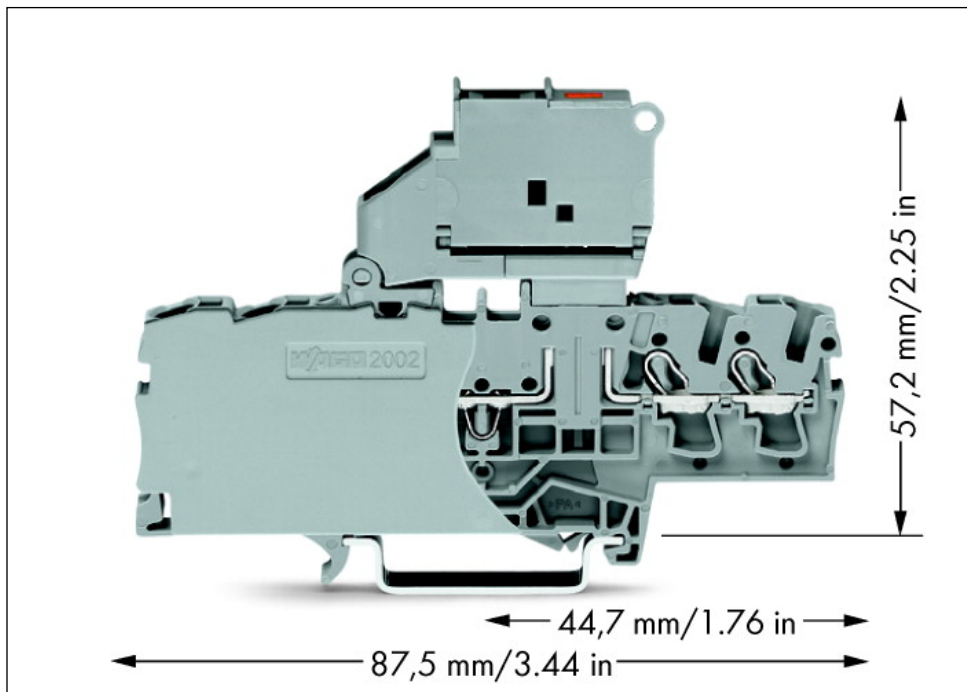
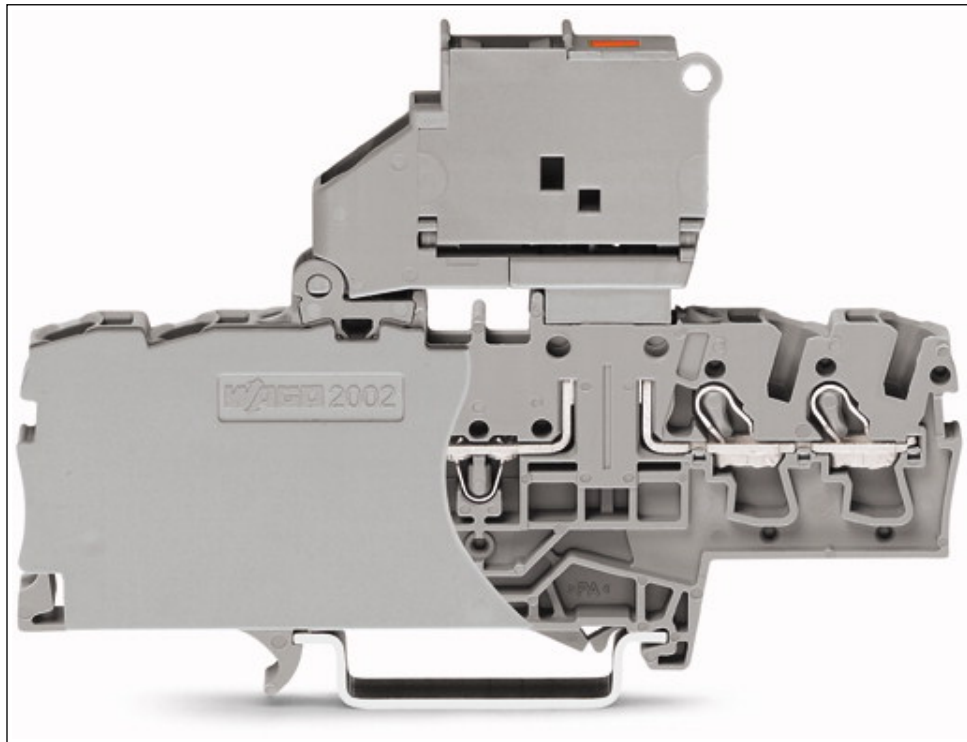

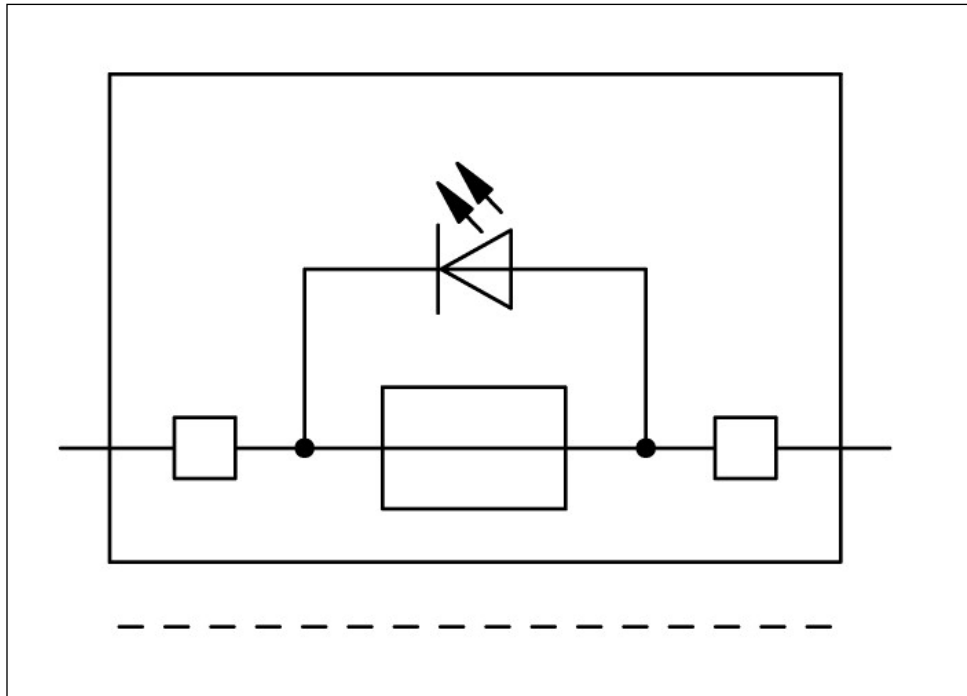

Address

WAGO Kontakttechnik GmbH & Co. KG

Hansastr. 27

32423 Minden

Telefon: 0571/887-0

Fax: 0571/887-169

<http://www.wago.com>

© WAGO Kontakttechnik GmbH & Co. KG

Technische Änderungen und Irrtümer vorbehalten.