

# UK Micro USB Power Supply - 2.5 Amp

**PowerPax**



This high power Micro USB UK Power Supply is rated to 5.1vdc 2.5 amps suitable for a wide range of applications, including powering the Raspberry Pi, charging various smartphones and tablets and a wide range of other electronic devices. This unit provides a highly reliable and efficient output meeting latest ErP stage 3 (CEC Level VI) requirements and carries full safety approvals for its intended market. Short circuit and over current protection as standard. This micro USB power supply has M.T.B.F of 50K hours at 25 degrees C.

<b>Part Numbers</b>	SW4600-UK
<b>Output</b>	5.1vdc 2.5A maximum
<b>Power</b>	12.75 Watts
<b>Line Reg</b>	+/-5% at rated load
<b>Total Output Regulation</b>	+/-5% at 0—100% load
<b>Ripple &amp; Noise (mV p-p)</b>	150mV P-P
<b>Protections</b>	Over Current and Short Circuit
<b>Case Size</b>	85.5 x 43.8 x 31.7mm
<b>DC Plug</b>	Micro USB
<b>Rated Input Voltage</b>	100-240Vac
<b>Full Input Voltage Range</b>	90-264Vac
<b>Rated Frequency</b>	50-60Hz
<b>Full Frequency Range</b>	47-63Hz
<b>Efficiency</b>	Level VI (80.34% minimum)

<b>Leakage Current</b>	shall not exceed 0.25mA
<b>Input Power (max)</b>	16.7W max
<b>Input Current (RMS Max.)</b>	0.5A max
<b>Hi-Pot Spec</b>	3000Vac 10mA 1 min. (I.P. to O.P.)
<b>Output cable</b>	1.5 Metres 20AWG 3.5Q round
<b>Operating Temperature</b>	0 to 40 degrees C
<b>Storage Temperature</b>	-20 to 80 degrees C
<b>Operating Humidity</b>	10% to 90%
<b>Safety Approvals</b>	BS EN60950-1 / CE marked
<b>EMC Standards</b>	EN55022:2010 Class B / FCC Part B
<b>MTBF</b>	50K Hours at 25 degrees C
<b>Polarity</b>	Pin 1 +, Pin 5—(Pin 2 & 3 short)
<b>MTBF</b>	50K Hours at 25 degrees C
<b>Plastic Case</b>	UL94V-1

Full spec sheet on this PSU is available on request. PowerPax Ltd accepts no responsibility for typographical errors in the production of this leaflet. Product specifications are subject to change without notice





# UK Micro USB Power Supply - 2.5 Amp





**PowerPax** (VI) 

P/N: SW4600-UK  
AC ADAPTOR PXXYY

INPUT: 100-240V ~ 50/60Hz 0.5A  
OUTPUT: 5.1V --- 2.5A

LPS    1(+) short 5(-)

  

PowerPax UK Ltd  
Unit 5 Kennet Weir Business Park, Arrowhead Road,  
Reading, Berkshire, RG7 4AD, United Kingdom

MADE IN CHINA

Dimensions:  $20.5_{-0.1}^{0.0}$  (width),  $31.5_{-0.1}^{0.0}$  (height)

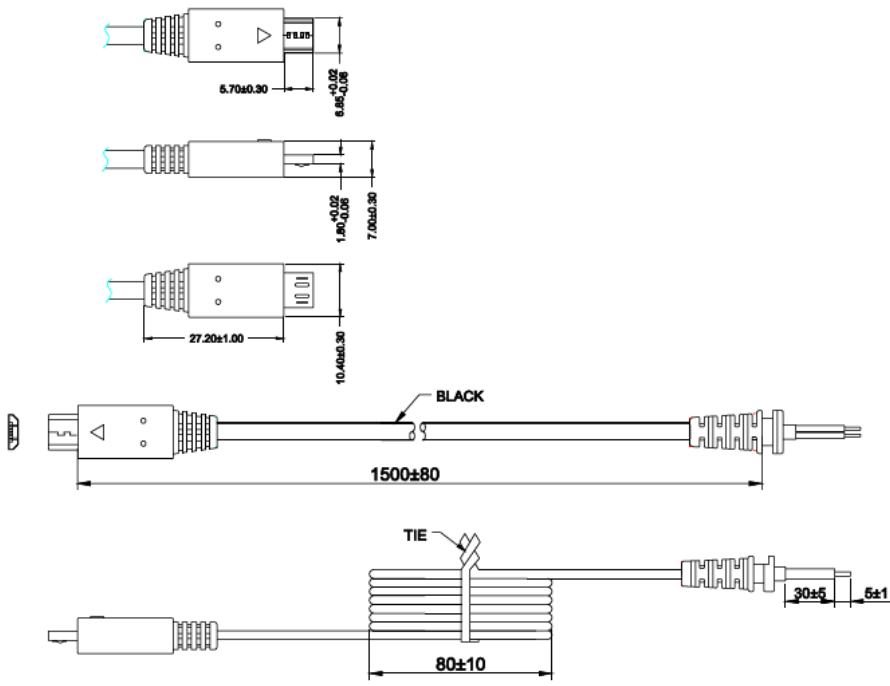

NOTE: 1. WIRE TYPE: VW-1 80°C 300V L=1500mm 1185 3.5Ø 18AWG BLACK  
2. THE POLARITY:  
3. PAHS REACH ROHS  1(+) short 5(-)

Full spec sheet on this PSU is available on request. PowerPax Ltd accepts no responsibility for typographical errors in the production of this leaflet. Product specifications are subject to change without notice



# UK Micro USB Power Supply - 2.5 Amp

**PowerPax**

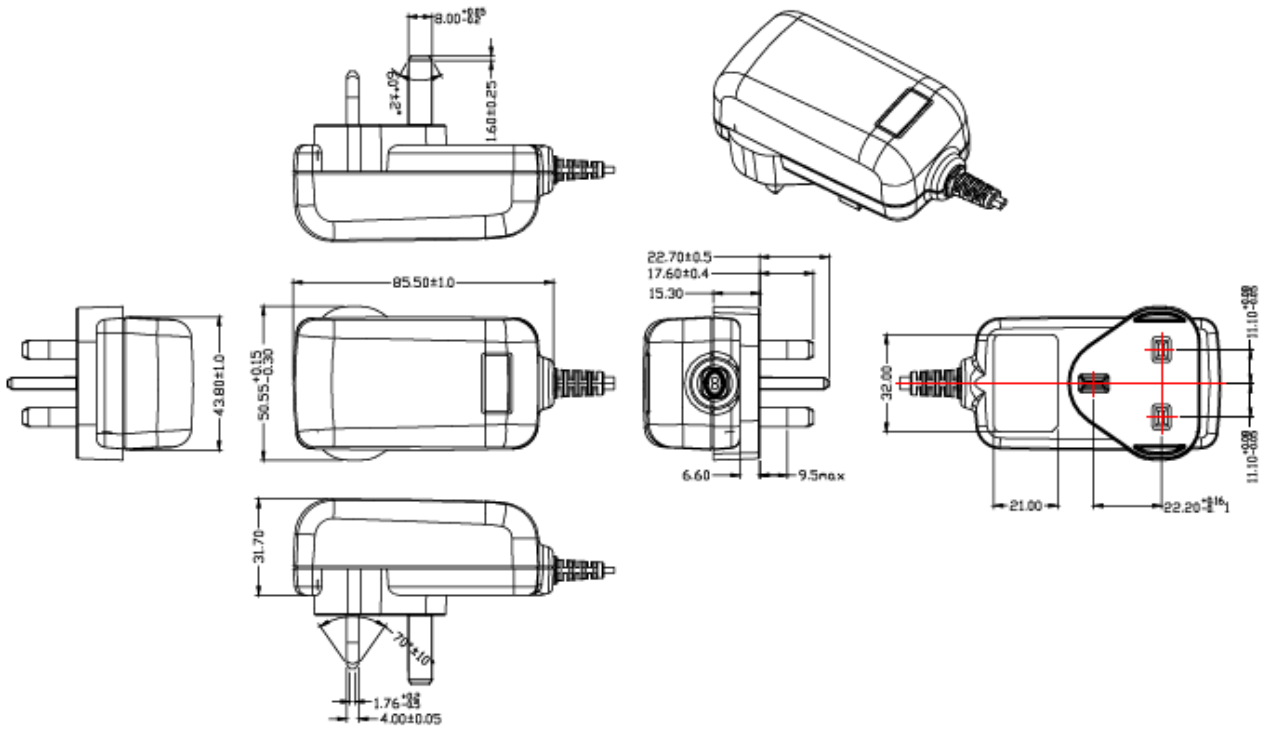

Full spec sheet on this PSU is available on request. PowerPax Ltd accepts no responsibility for typographical errors in the production of this leaflet. Product specifications are subject to change without notice

