

# USA Micro USB Power Supply 2.5 Amp

**PowerPax**



This high power Micro USB USA Power Supply is rated to 5.1vdc 2.5 amps suitable for a wide range of applications, including powering the Raspberry Pi, charging various smartphones and tablets and a wide range of other electronic devices. This unit provides a highly reliable and efficient output meeting latest ErP stage 3 (CEC Level VI) requirements and carries full safety approvals for its intended market. Short circuit and over current protection as standard. This micro USB power supply has M.T.B.F of 50K hours at 25 degrees C.

<b>Part Numbers</b>	SW4600-UL	<b>Leakage Current</b>	shall not exceed 0.25mA
<b>Output</b>	5.1vdc 2.5A maximum	<b>Input Power (max)</b>	16.7W max
<b>Power</b>	12.75 Watts	<b>Input Current (RMS Max.)</b>	0.5A max
<b>Line Reg</b>	+/-5% at rated load	<b>Hi-Pot Spec</b>	3000Vac 10mA 1 min. (I.P. to O.P.)
<b>Total Output Regulation</b>	+/-5% at 0—100% load	<b>Output cable</b>	1.5 Metres 20AWG 3.5Q round
<b>Ripple &amp; Noise (mV p-p)</b>	150mV P-P	<b>Operating Temperature</b>	0 to 40 degrees C
<b>Protections</b>	Over Current and Short Circuit	<b>Storage Temperature</b>	-20 to 80 degrees C
<b>Case Size</b>	85.5 x 43.8 x 31.7mm	<b>Operating Humidity</b>	10% to 90%
<b>DC Plug</b>	Micro USB	<b>Safety Approvals</b>	UL
<b>Rated Input Voltage</b>	100-240Vac	<b>EMC Standards</b>	FCC Part B
<b>Full Input Voltage Range</b>	90-264Vac	<b>MTBF</b>	50K Hours at 25 degrees C
<b>Rated Frequency</b>	50-60Hz	<b>Polarity</b>	Pin 1 +, Pin 5—(Pin 2 & 3 short)
<b>Full Frequency Range</b>	47-63Hz	<b>MTBF</b>	50K Hours at 25 degrees C
<b>Efficiency</b>	Level VI (80.34% minimum)	<b>Plastic Case</b>	UL94V-1

Full spec sheet on this PSU is available on request. PowerPax Ltd accepts no responsibility for typographical errors in the production of this leaflet. Product specifications are subject to change without notice

# USA Micro USB Power Supply 2.5 Amp

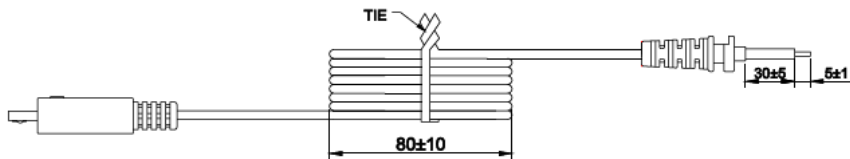
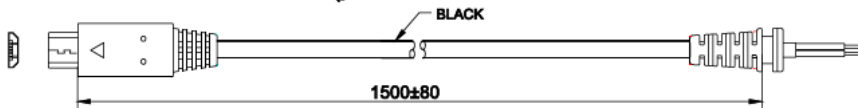
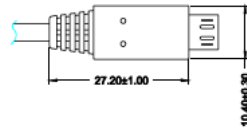
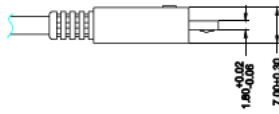
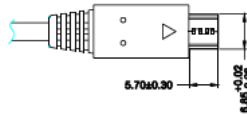
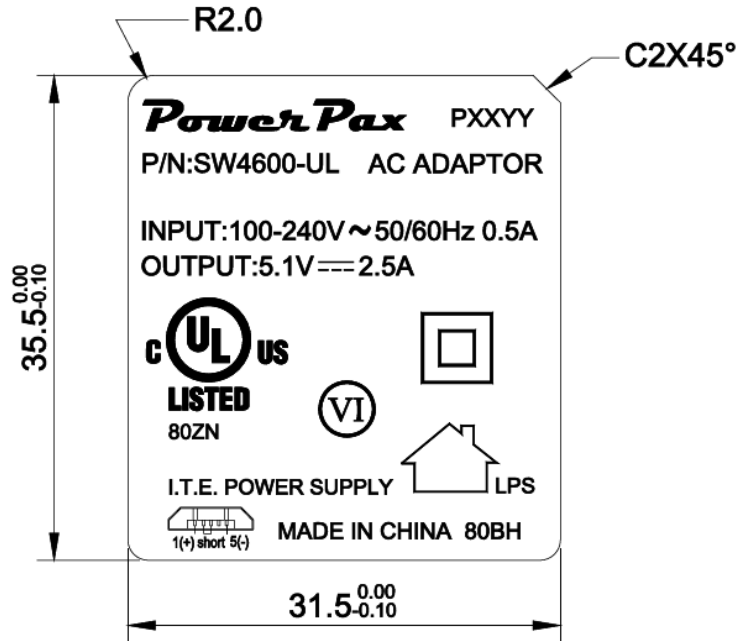

NOTE:1.WIRE TYPE:VW-1 80°C 300V L=1500mm 1185 3.5Ø 18AWG BLACK  
 2.THE POLARITY:  
 3.PAHS REACH ROHS

Full spec sheet on this PSU is available on request. PowerPax Ltd accepts no responsibility for typographical errors in the production of this leaflet. Product specifications are subject to change without notice

# USA Micro USB Power Supply 2.5 Amp

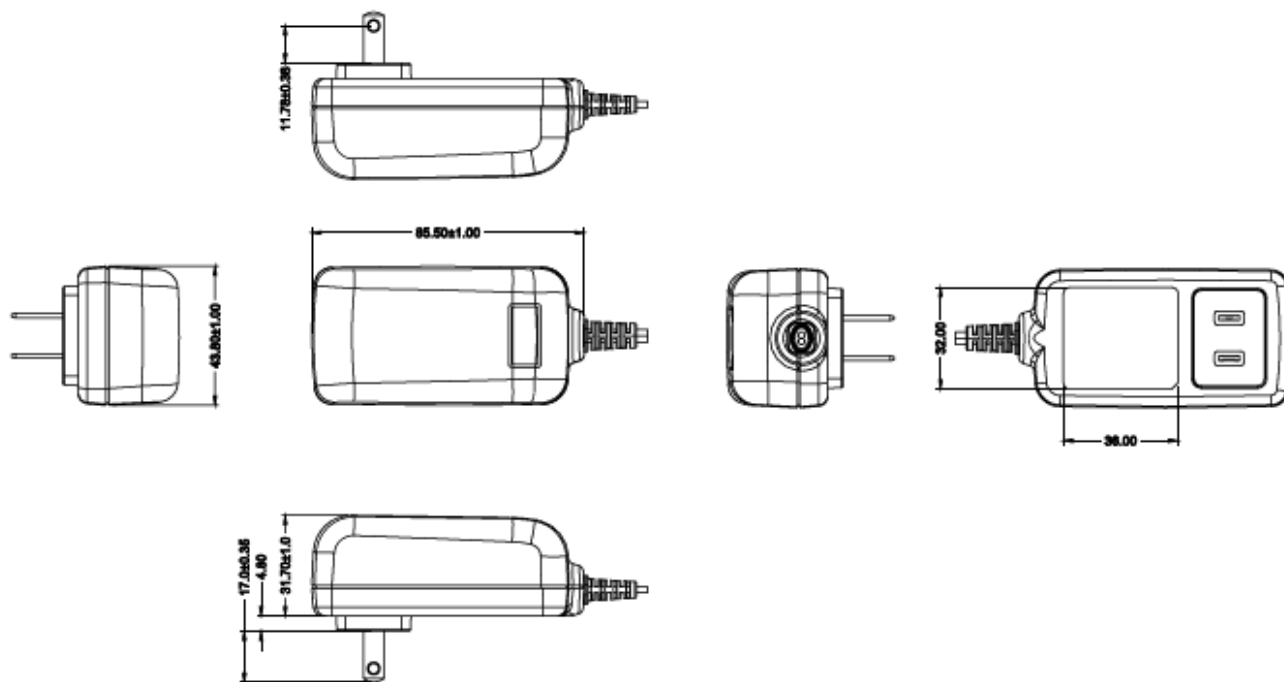

Full spec sheet on this PSU is available on request. PowerPax Ltd accepts no responsibility for typographical errors in the production of this leaflet. Product specifications are subject to change without notice