



# FIN1002 LVDS 1-Bit, High-Speed Differential Receiver

## Features

- Greater than 400 Mbs Data Rate
- 3.3 V Power Supply Operation
- 0.4 ns Maximum Pulse Skew
- 2.5 ns Maximum Propagation Delay
- Bus Pin ESD (HBM) Protection Exceeds 10 kV
- Power-Off, Over-voltage tolerant Input and Output
- Fail-safe Protection for open-circuit and non-driven, shorted, or terminated Conditions
- High-impedance Output at  $V_{CC} < 1.5$  V
- Meets or exceeds TIA/EIA-644 LVDS Standard
- 5-Lead SOT23 Package saves Space

## Description

This single receiver is designed for high-speed interconnects utilizing Low Voltage Differential Signaling (LVDS) technology. The receiver translates LVDS levels, with a typical differential input threshold of 100 mV, to LVTTTL signal levels. LVDS provides low EMI at ultra low power dissipation even at high frequencies. This device is ideal for high-speed transfer of clock or data. The FIN1002 can be paired with its companion driver, the FIN1001, or with any other LVDS driver.

## Ordering Information

| Part Number | Operating Temperature Range | Package                            | Packing Method | Packing Quantity |
|-------------|-----------------------------|------------------------------------|----------------|------------------|
| FIN1002M5   | -40 to +125°C               | 5-Lead SOT23, JEDEC MO-178, 1.6 mm | Tube           | 250              |
| FIN1002M5X  | -40 to +125°C               | 5-Lead SOT23, JEDEC MO-178, 1.6 mm | Tape & Reel    | 3000             |

## Connection Diagram

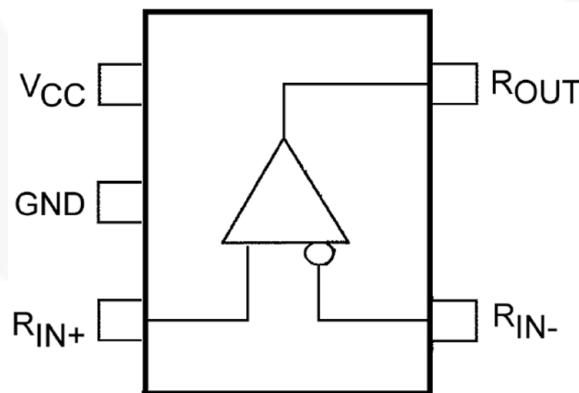


Figure 1. Top View

## Pin Configuration

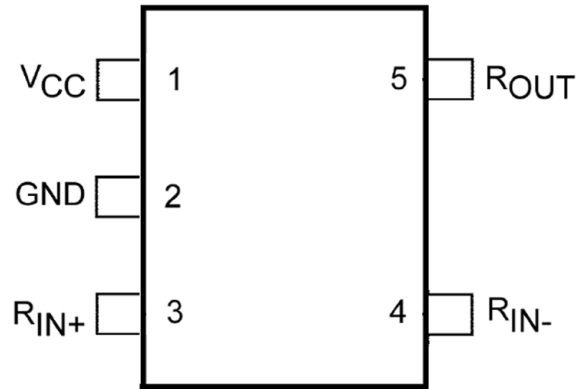


Figure 2. Pin Configuration

## Pin Definitions

| Pin # | Name             | Description                |
|-------|------------------|----------------------------|
| 1     | V <sub>CC</sub>  | Power Supply               |
| 2     | GND              | Ground for the IC          |
| 3     | R <sub>IN+</sub> | Non-inverting Driver Input |
| 4     | R <sub>IN-</sub> | Inverting Driver Input     |
| 5     | R <sub>OUT</sub> | LVTTTL Data Output         |

## Function Table

| Inputs  |                  | Outputs          |
|---|------------------|------------------|
| R <sub>IN+</sub>                                | R <sub>IN-</sub> | R <sub>OUT</sub> |
| LOW   | HIGH             | LOW              |
| HIGH  | LOW              | HIGH             |
| Fail-Safe Condition (Open, Shorted, Terminated) |                  | HIGH             |

## Absolute Maximum Ratings

Stresses exceeding the absolute maximum ratings may damage the device. The device may not function or be operable above the recommended operating conditions and stressing the parts to these levels is not recommended. In addition, extended exposure to stresses above the recommended operating conditions may affect device reliability. The absolute maximum ratings are stress ratings only.

| Symbol              | Parameter                               |                  | Min. | Max. | Unit |
|---------------------|---|------------------|------|------|------|
| $V_{CC}$            | Supply Voltage                          |                  | -0.5 | 4.6  | V    |
| $R_{IN+} / R_{IN-}$ | Input Voltage                           |                  | -0.5 | 4.6  | V    |
| $D_{OUT}$           | DC Output Voltage                       |                  | -0.5 | 6.0  | V    |
| $I_O$               | Output Current                          |                  |      | 16   | mA   |
| $T_{STG}$           | Storage Temperature Range               |                  | -65  | +150 | °C   |
| $T_J$               | Maximum Junction Temperature            |                  |      | +150 | °C   |
| $T_L$               | Lead Temperature, Soldering, 10 Seconds |                  |      | +260 | °C   |
| ESD                 | Electrostatic Discharge                 | Human Body Model |      | 8    | kV   |
|                     |   | LVDS Pins to GND |      | 10   |      |
|                     |   | Machine Model    |      | 400  | V    |

## Recommended Operating Conditions

The Recommended Operating Conditions table defines the conditions for actual device operation. Recommended operating conditions are specified to ensure optimal performance to the datasheet specifications. Fairchild does not recommend exceeding them or designing to Absolute Maximum Ratings.

| Symbol   | Parameter                         | Min.               | Max.                 | Unit |
|----------|-----------------------------------|--------------------|----------------------|------|
| $V_{CC}$ | Supply Voltage                    | 3.0                | 3.6                  | V    |
| $V_{IN}$ | Input Voltage                     | 0                  | $V_{CC}$             | V    |
| $V_{ID}$ | Magnitude of Differential Voltage | 100                | $V_{CC}$             | mV   |
| $V_{IC}$ | Common-mode Input Voltage         | $0 +  V_{ID}  / 2$ | $2.4 -  V_{ID}  / 2$ | V    |
| $T_A$    | Operating Temperature             | -40                | +125                 | °C   |

## DC Electrical Characteristics<sup>(1)</sup>

All min. and max. values are guaranteed at  $T_A = -40$  to  $+125^\circ\text{C}$ . All typical values are at  $T_A = 25^\circ\text{C}$  and with  $V_{CC} = 3.3$  V, unless otherwise specified.

| Symbol       | Parameter                         | Conditions  | Min.           | Typ. | Max.     | Units         |
|--------------|-----------------------------------|---|----------------|------|----------|---------------|
| $V_{TH}$     | Differential Input Threshold HIGH | $V_{IC} = +0.05$ V, 1.2 V, or 2.35 V<br>Figure 3  |                |      | 100      | mV            |
| $V_{TL}$     | Differential Input Threshold LOW  | $V_{IC} = +0.05$ V, 1.2 V, or 2.35 V<br>Figure 3  | -100           |      |          | mV            |
| $I_{IN}$     | Input Current                     | $V_{IN} = 0$ V or $V_{CC}$  |                |      | $\pm 20$ | $\mu\text{A}$ |
| $I_{I(OFF)}$ | Power-OFF Input Current           | $V_{CC} = 0$ V, $V_{IN} = 0$ V or 3.6 V   |                |      | $\pm 20$ | $\mu\text{A}$ |
| $V_{OH}$     | Output HIGH Voltage               | $I_{OH} = -100$ $\mu\text{A}$   | $V_{CC} - 0.2$ | 3.3  |          | V             |
|              |                                   | $I_{OH} = -8$ mA  | 2.4            | 3.1  |          |               |
| $V_{OL}$     | Output LOW Voltage                | $I_{OH} = 100$ $\mu\text{A}$  |                | 0    | 0.2      | V             |
|              |                                   | $I_{OL} = 8$ mA   |                | 0.16 | 0.50     |               |
| $V_{IK}$     | Input Clamp Voltage               | $I_{IK} = -18$ mA   | -1.5           | 0.8  |          | V             |
| $I_{CC}$     | Power Supply Current              | ( $R_{IN+} = 1$ V and $R_{IN-} = 1.4$ V) or<br>( $R_{IN+} = 1.4$ V and $R_{IN-} = 1$ V) |                | 4    | 7        | mA            |
| $C_{IN}$     | Input Capacitance                 | $V_{CC} = 3.3$ V  |                | 2.3  |          | pF            |
| $C_{OUT}$    | Output Capacitance                | $V_{CC} = 0$ V  |                | 2.8  |          | pF            |

### Note:

- Not production tested across the full temperature range.

## AC Electrical Characteristics

All min. and max. values are guaranteed at  $T_A = -40$  to  $+85^\circ\text{C}$ . All typical values are at  $T_A = 25^\circ\text{C}$  and with  $V_{CC} = 3.3$  V, unless otherwise specified.

$|V_{ID}| = 400$  mV,  $C_L = 10$  pF. See Figure 3 and Figure 4.

| Symbol       | Parameter                        | Conditions            | Min. | Typ. | Max. | Units |
|--------------|----------------------------------|-----------------------|------|------|------|-------|
| $t_{PLH}$    | Propagation Delay                | LOW to HIGH           | 0.9  | 1.5  | 2.5  | ns    |
| $t_{PHL}$    | Propagation Delay                | HIGH to LOW           | 0.9  | 1.5  | 2.5  | ns    |
| $t_{TLH}$    | Output Rise Time                 | 20% to 80%            |      | 0.6  |      | ns    |
| $t_{THL}$    | Output Fall Time                 | 80% to 20%            |      | 0.5  |      | ns    |
| $t_{SK(p)}$  | Pulse Skew                       | $ t_{PLH} - t_{PHL} $ |      | 0.02 | 0.4  | ns    |
| $t_{SK(PP)}$ | Part-to-Part Skew <sup>(2)</sup> |                       |      |      | 1.0  | ns    |

### Note:

- $t_{SK(PP)}$  is the magnitude of the difference in propagation delay times between any specified terminals of two devices switching in the same direction (either LOW-to-HIGH or HIGH-to-LOW) when both devices operate with the same supply voltage, same temperature, and have identical test circuits.

Test Diagrams

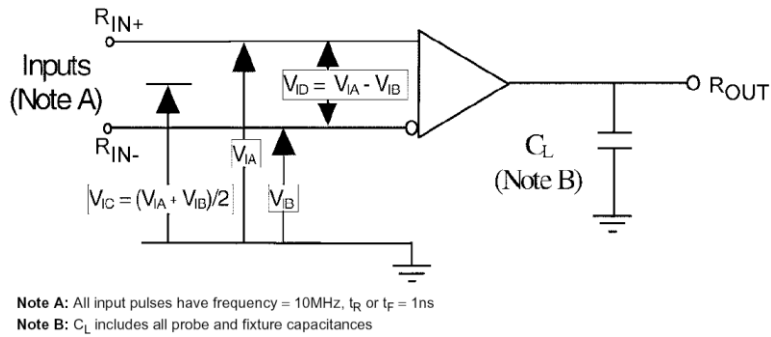


Figure 3. Differential Receiver Voltage Definitions and Propagation Delay and Transition Time Test Circuit

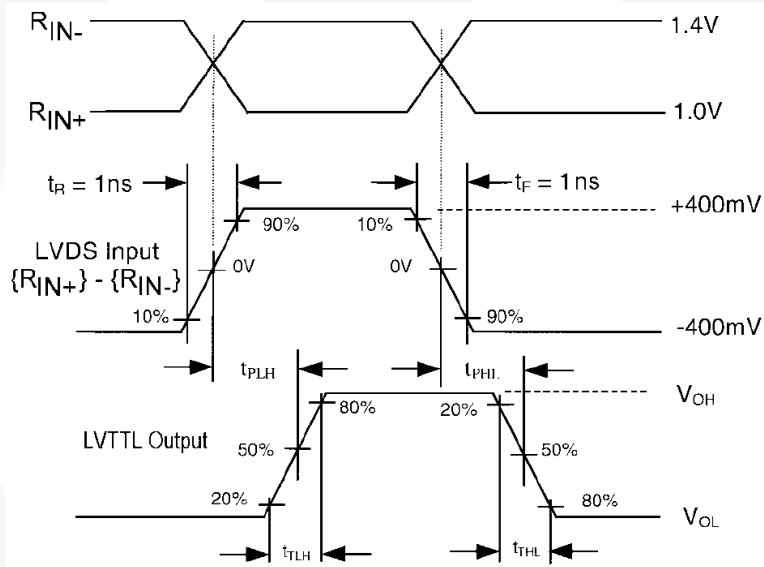
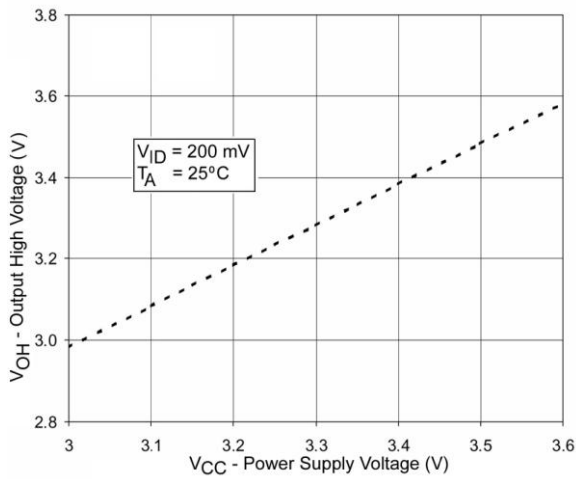
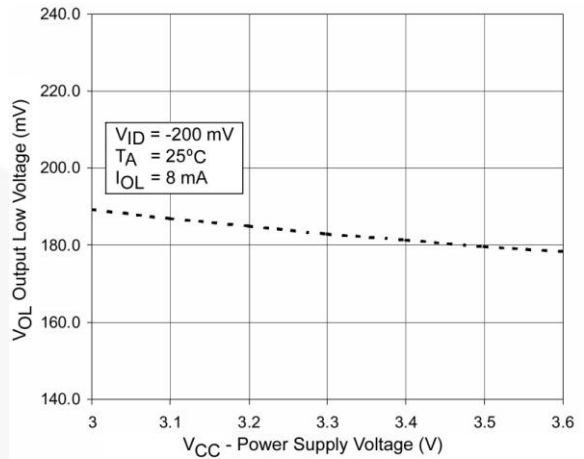


Figure 4. LVDS Input to LVTTTL Output AC Waveforms

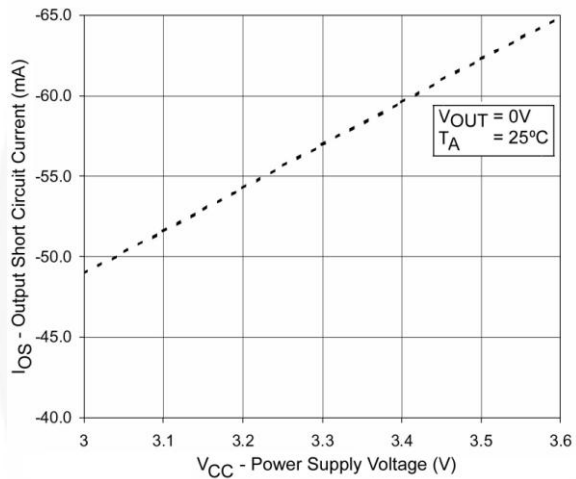
## Typical Performance Characteristics



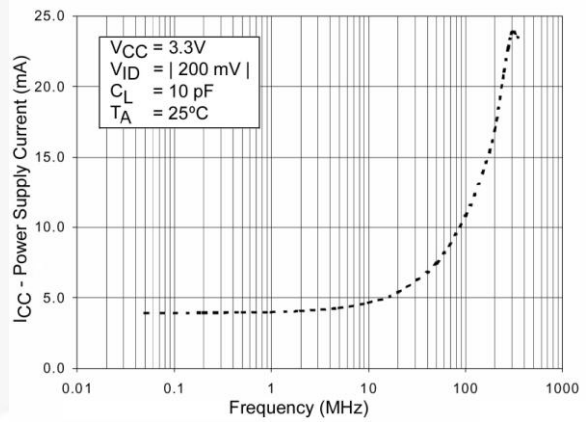
**Figure 5. Output High Voltage vs. Power Supply Voltage**



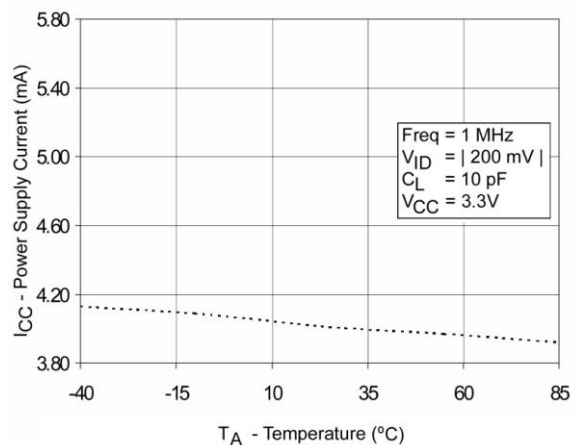
**Figure 6. Output Low Voltage vs. Power Supply Voltage**



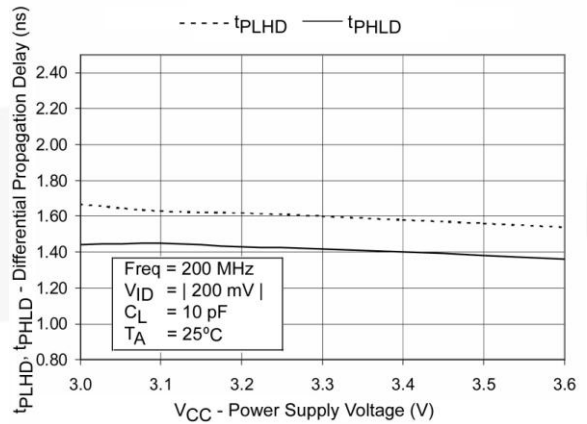
**Figure 7. Output Short Circuit Current vs. Power Supply Voltage**



**Figure 8. Power Supply Current vs. Frequency**

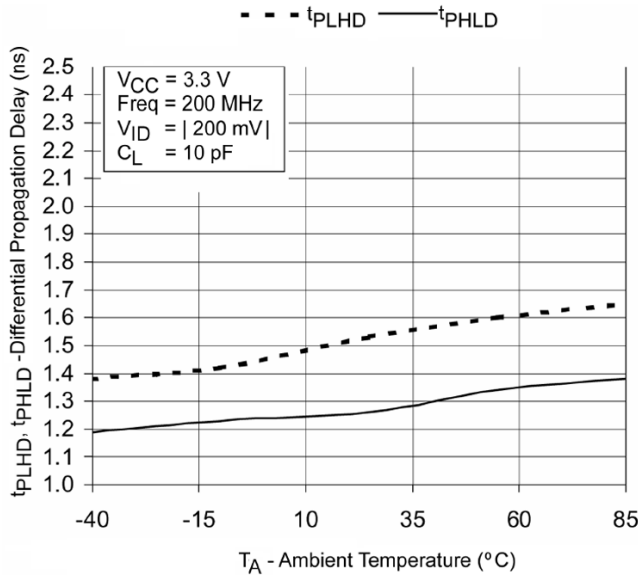


**Figure 9. Power Supply Current vs. Ambient Temperature**

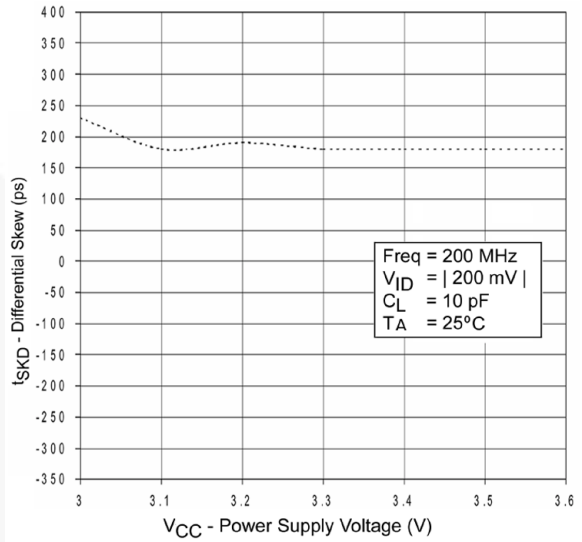


**Figure 10. Differential Propagation Delay Power Supply Voltage**

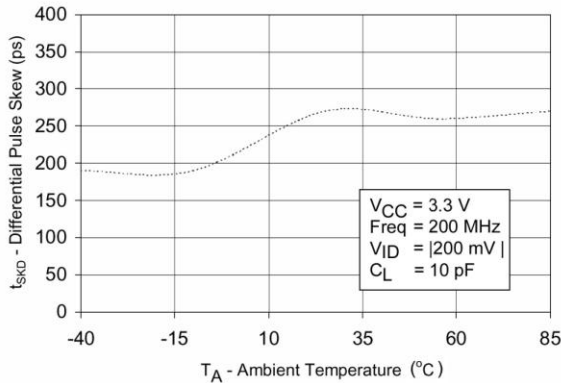
**Typical Performance Characteristics (Continued)**



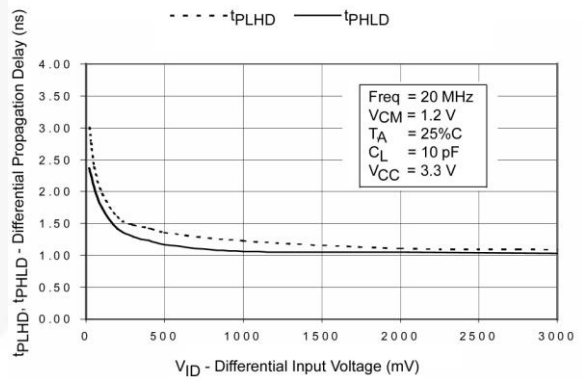
**Figure 11. Differential Propagation Delay vs. Ambient Temperature**



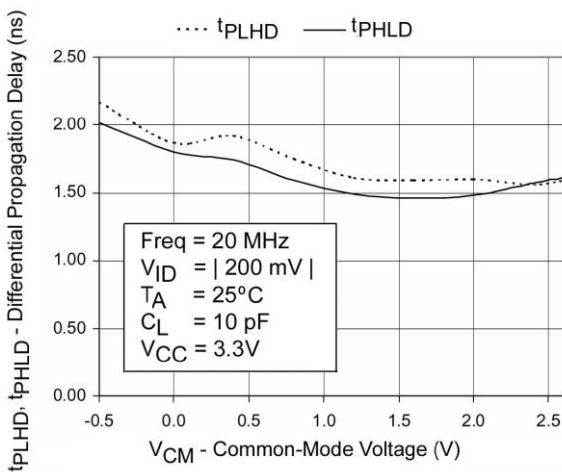
**Figure 12. Differential Skew vs. Power Supply Voltage**



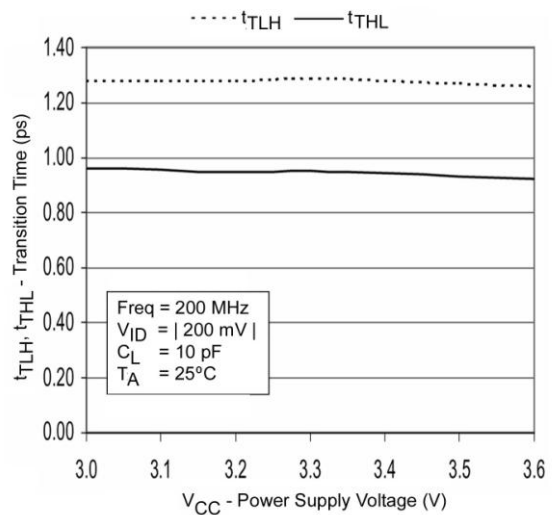
**Figure 13. Differential Skew vs. Ambient Temperature**



**Figure 14. Differential Propagation Delay vs. Differential Input Voltage**



**Figure 15. Differential Propagation Delay vs. Common-Mode Voltage**



**Figure 16. Transition Time vs. Power Supply Voltage**

### Typical Performance Characteristics (Continued)

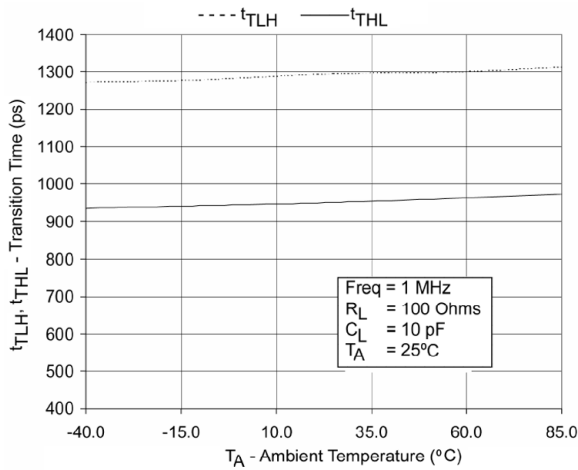


Figure 17. Transition Time vs. Ambient Temperature

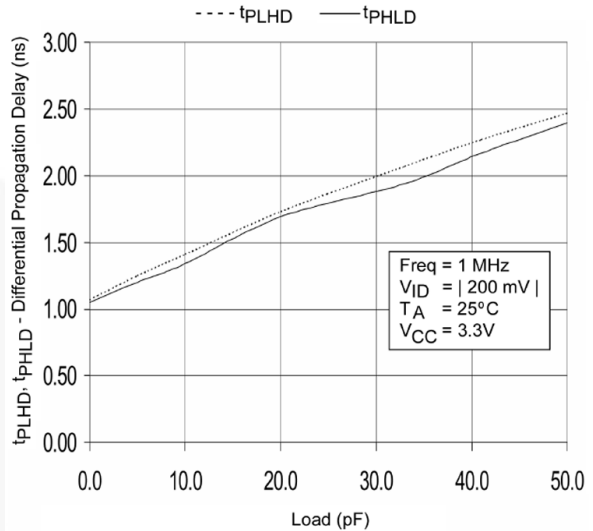


Figure 18. Differential Propagation Delay vs. Load

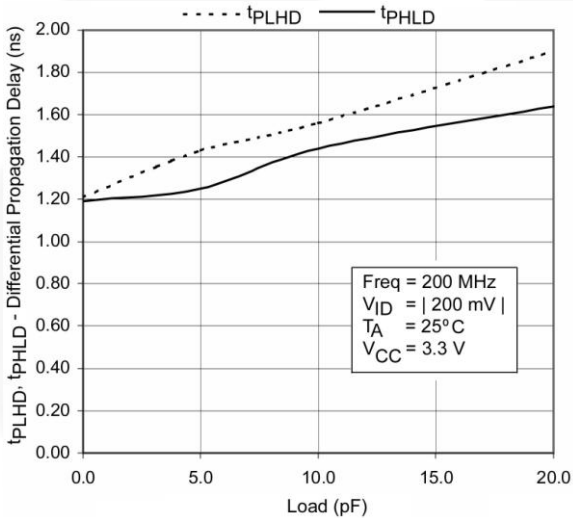


Figure 19. Differential Propagation Delay vs. Load

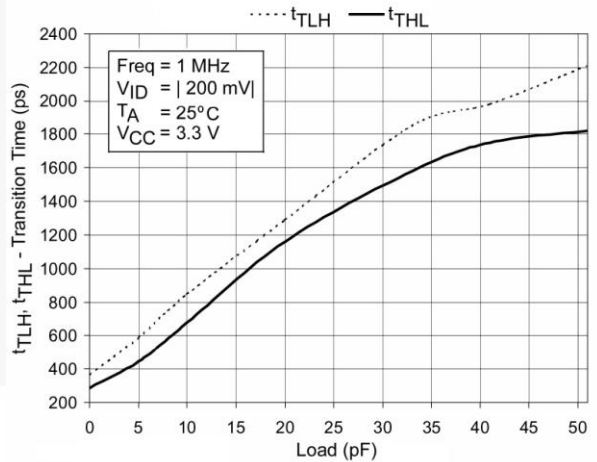


Figure 20. Transition Time vs. Load

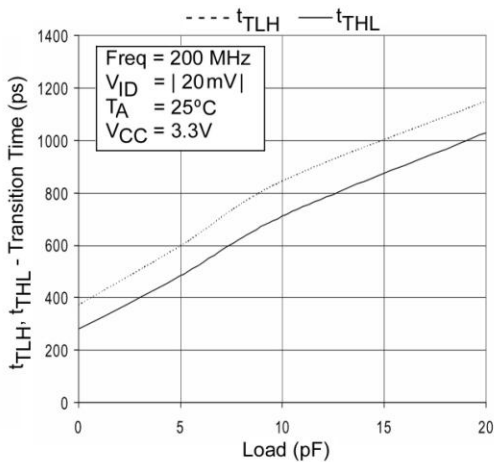


Figure 21. Transition Time vs. Load

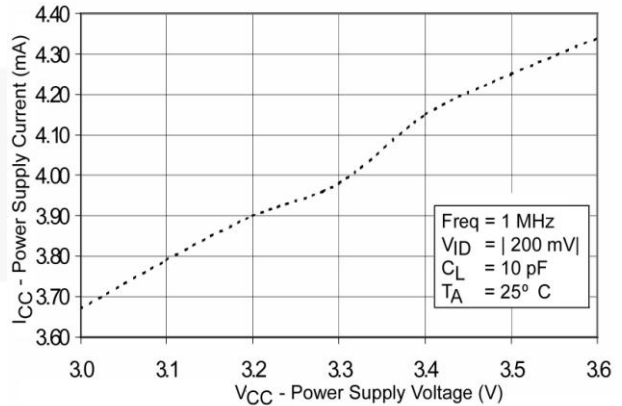
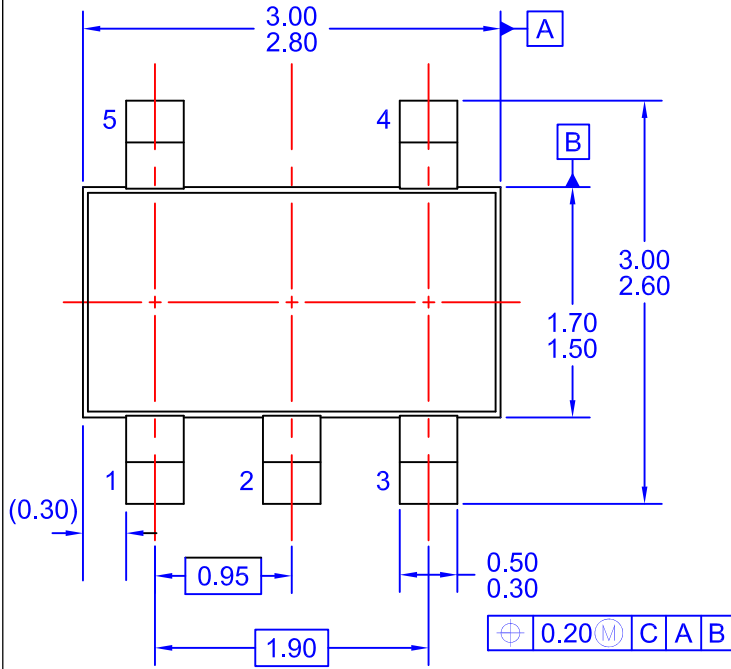
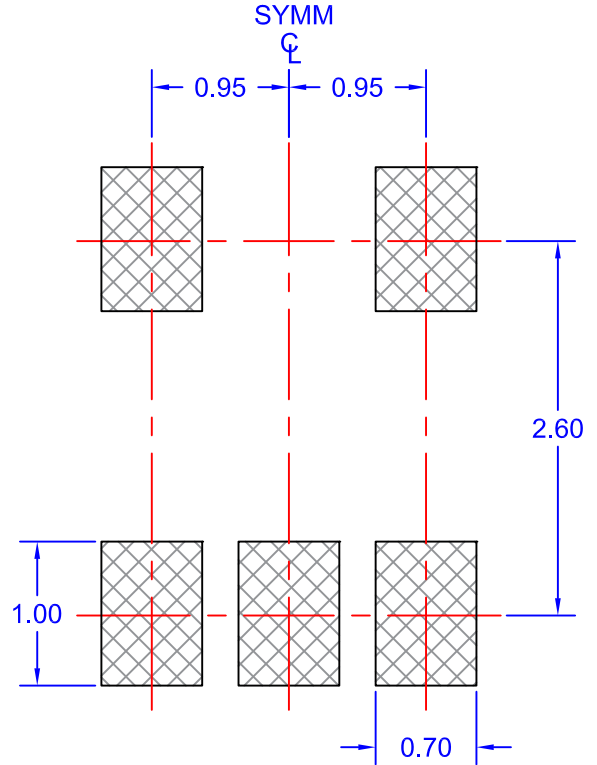


Figure 22. Power Supply Current vs. Power Supply Voltage

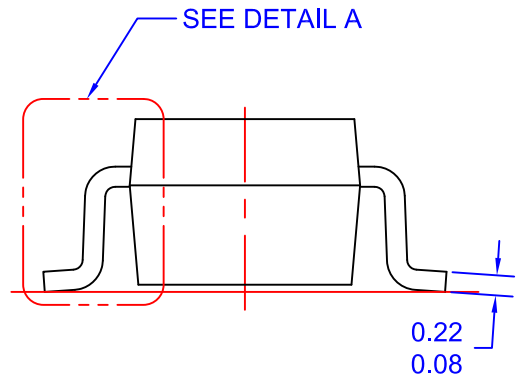
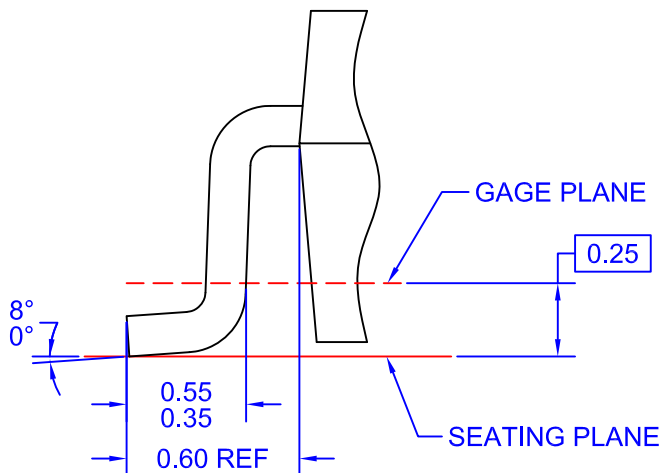
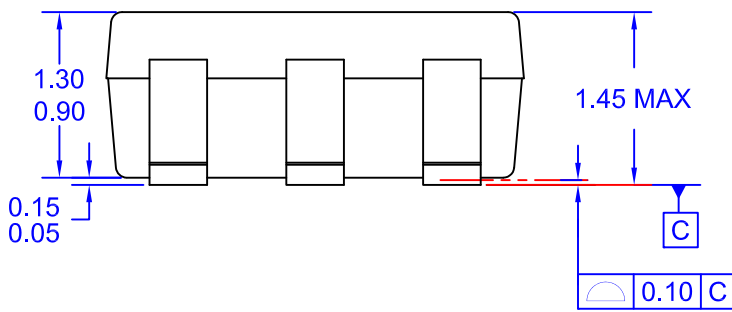




TOP VIEW



LAND PATTERN RECOMMENDATION



- NOTES: UNLESS OTHERWISE SPECIFIED
- A) PACKAGE STANDARD REFERENCE: JEDEC REGISTRATION, MO-178, ISSUE B, VARIATION AA.
  - B) ALL DIMENSIONS ARE IN MILLIMETERS.
  - C) DIMENSIONS DO NOT INCLUDE BURRS OR MOLD FLASH. MOLD FLASH OR BURRS DOES NOT EXCEED 0.10MM.
  - D) DIMENSIONING AND TOLERANCING PER ASME Y14.5M-2009.
  - E) DRAWING FILE NAME: MKT-MA05BREV6





**TRADEMARKS**

The following includes registered and unregistered trademarks and service marks, owned by Fairchild Semiconductor and/or its global subsidiaries, and is not intended to be an exhaustive list of all such trademarks.

- AccuPower™
- AttitudeEngine™
- Awinda®
- AX-CAP®\*
- BitSiC™
- Build it Now™
- CorePLUS™
- CorePOWER™
- CROSSVOL™
- CTL™
- Current Transfer Logic™
- DEUXPEED®
- Dual Cool™
- EcoSPARK®
- EfficientMax™
- ESBC™
- F**™
- Fairchild®
- Fairchild Semiconductor®
- FACT Quiet Series™
- FACT®
- FastvCore™
- FETBench™
- FPS™
- F-PFS™
- FRFET®
- Global Power Resource<sup>SM</sup>
- GreenBridge™
- Green FPS™
- Green FPS™ e-Series™
- Gmax™
- GTO™
- IntelliMAX™
- ISOPLANAR™
- Making Small Speakers Sound Louder and Better™
- MegaBuck™
- MICROCOUPLER™
- MicroFET™
- MicroPak™
- MicroPak2™
- MillerDrive™
- MotionMax™
- MotionGrid®
- MTi®
- MTx®
- MVN®
- mWSaver®
- OptoHiT™
- OPTOLOGIC®
- OPTOPLANAR®
- ®
- Power Supply WebDesigner™
- PowerTrench®
- PowerXS™
- Programmable Active Droop™
- QFET®
- QS™
- Quiet Series™
- RapidConfigure™
- ™
- Saving our world, 1mW/W/kW at a time™
- SignalWise™
- SmartMax™
- SMART START™
- Solutions for Your Success™
- SPM®
- STEALTH™
- SuperFET®
- SuperSOT™-3
- SuperSOT™-6
- SuperSOT™-8
- SupreMOS®
- SyncFET™
- Sync-Lock™
- ®
- TinyBoost®
- TinyBuck®
- TinyCalc™
- TinyLogic®
- TINYOPTO™
- TinyPower™
- TinyPWM™
- TinyWire™
- TranSiC™
- TriFault Detect™
- TRUECURRENT®\*
- μSerDes™
- ™
- UHC®
- Ultra FRFET™
- UniFET™
- VCX™
- VisualMax™
- VoltagePlus™
- XS™
- Xsens™
- 仙童®

\* Trademarks of System General Corporation, used under license by Fairchild Semiconductor.

**DISCLAIMER**

FAIRCHILD SEMICONDUCTOR RESERVES THE RIGHT TO MAKE CHANGES WITHOUT FURTHER NOTICE TO ANY PRODUCTS HEREIN TO IMPROVE RELIABILITY, FUNCTION, OR DESIGN. TO OBTAIN THE LATEST, MOST UP-TO-DATE DATASHEET AND PRODUCT INFORMATION, VISIT OUR WEBSITE AT [HTTP://WWW.FAIRCHILDSEMI.COM](http://www.fairchildsemi.com). FAIRCHILD DOES NOT ASSUME ANY LIABILITY ARISING OUT OF THE APPLICATION OR USE OF ANY PRODUCT OR CIRCUIT DESCRIBED HEREIN; NEITHER DOES IT CONVEY ANY LICENSE UNDER ITS PATENT RIGHTS, NOR THE RIGHTS OF OTHERS. THESE SPECIFICATIONS DO NOT EXPAND THE TERMS OF FAIRCHILD'S WORLDWIDE TERMS AND CONDITIONS, SPECIFICALLY THE WARRANTY THEREIN, WHICH COVERS THESE PRODUCTS.

**AUTHORIZED USE**

Unless otherwise specified in this data sheet, this product is a standard commercial product and is not intended for use in applications that require extraordinary levels of quality and reliability. This product may not be used in the following applications, unless specifically approved in writing by a Fairchild officer: (1) automotive or other transportation, (2) military/aerospace, (3) any safety critical application – including life critical medical equipment – where the failure of the Fairchild product reasonably would be expected to result in personal injury, death or property damage. Customer's use of this product is subject to agreement of this Authorized Use policy. In the event of an unauthorized use of Fairchild's product, Fairchild accepts no liability in the event of product failure. In other respects, this product shall be subject to Fairchild's Worldwide Terms and Conditions of Sale, unless a separate agreement has been signed by both Parties.

**ANTI-COUNTERFEITING POLICY**

Fairchild Semiconductor Corporation's Anti-Counterfeiting Policy. Fairchild's Anti-Counterfeiting Policy is also stated on our external website, [www.fairchildsemi.com](http://www.fairchildsemi.com), under Terms of Use

Counterfeiting of semiconductor parts is a growing problem in the industry. All manufacturers of semiconductor products are experiencing counterfeiting of their parts. Customers who inadvertently purchase counterfeit parts experience many problems such as loss of brand reputation, substandard performance, failed applications, and increased cost of production and manufacturing delays. Fairchild is taking strong measures to protect ourselves and our customers from the proliferation of counterfeit parts. Fairchild strongly encourages customers to purchase Fairchild parts either directly from Fairchild or from Authorized Fairchild Distributors who are listed by country on our web page cited above. Products customers buy either from Fairchild directly or from Authorized Fairchild Distributors are genuine parts, have full traceability, meet Fairchild's quality standards for handling and storage and provide access to Fairchild's full range of up-to-date technical and product information. Fairchild and our Authorized Distributors will stand behind all warranties and will appropriately address any warranty issues that may arise. Fairchild will not provide any warranty coverage or other assistance for parts bought from Unauthorized Sources. Fairchild is committed to combat this global problem and encourage our customers to do their part in stopping this practice by buying direct or from authorized distributors.

**PRODUCT STATUS DEFINITIONS**

**Definition of Terms**

| Datasheet Identification | Product Status        | Definition  |
|--------------------------|-----------------------|---|
| Advance Information      | Formative / In Design | Datasheet contains the design specifications for product development. Specifications may change in any manner without notice.   |
| Preliminary              | First Production      | Datasheet contains preliminary data; supplementary data will be published at a later date. Fairchild Semiconductor reserves the right to make changes at any time without notice to improve design. |
| No Identification Needed | Full Production       | Datasheet contains final specifications. Fairchild Semiconductor reserves the right to make changes at any time without notice to improve the design.   |
| Obsolete                 | Not In Production     | Datasheet contains specifications on a product that is discontinued by Fairchild Semiconductor. The datasheet is for reference information only.  |

Rev. I77