

SKM150GB12VG



SEMITRANS® 3

SKM150GB12VG

Features

- V-IGBT = 6. Generation Trench V-IGBT (Fuji)
- CAL4 = Soft switching 4. Generation CAL-diode
- Isolated copper baseplate using DBC technology (Direct Copper Bonding)
- UL recognized, file no. E63532
- Increased power cycling capability
- With integrated gate resistor
- Low switching losses at high di/dt

Typical Applications*

- AC inverter drives
- UPS
- Electronic welders

Remarks

- Case temperature limited to $T_c = 125^\circ\text{C}$ max, recomm. $T_{op} = -40 \dots +150^\circ\text{C}$, product rel. results valid for $T_j = 150^\circ$

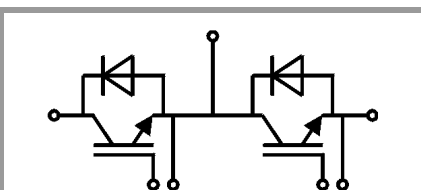

GB

Absolute Maximum Ratings

| Symbol | Conditions | Values | Unit | |
|----------------------|--|---------------------------|------------------|---|
| IGBT | | | | |
| V_{CES} | $T_j = 25^\circ\text{C}$ | 1200 | V | |
| I_C | $T_j = 175^\circ\text{C}$ | $T_c = 25^\circ\text{C}$ | 222 | A |
| | | $T_c = 80^\circ\text{C}$ | 169 | A |
| I_{Cnom} | | 150 | A | |
| I_{CRM} | $I_{CRM} = 3 \times I_{Cnom}$ | 450 | A | |
| V_{GES} | | -20 ... 20 | V | |
| t_{psc} | $V_{CC} = 720\text{ V}$ | 10 | μs | |
| | $V_{GE} \leq 20\text{ V}$ | | | |
| | $V_{CES} \leq 1200\text{ V}$ | $T_j = 125^\circ\text{C}$ | | |
| T_j | | -40 ... 175 | $^\circ\text{C}$ | |
| Inverse diode | | | | |
| I_F | $T_j = 175^\circ\text{C}$ | $T_c = 25^\circ\text{C}$ | 187 | A |
| | | $T_c = 80^\circ\text{C}$ | 140 | A |
| I_{Fnom} | | 150 | A | |
| I_{FRM} | $I_{FRM} = 3 \times I_{Fnom}$ | 450 | A | |
| I_{FSM} | $t_p = 10\text{ ms, sin } 180^\circ, T_j = 25^\circ\text{C}$ | 774 | A | |
| T_j | | -40 ... 175 | $^\circ\text{C}$ | |
| Module | | | | |
| $I_{t(RMS)}$ | $T_{terminal} = 80^\circ\text{C}$ | 500 | A | |
| T_{stg} | | -40 ... 125 | $^\circ\text{C}$ | |
| V_{isol} | AC sinus 50Hz, $t = 1\text{ min}$ | 4000 | V | |

Characteristics

| Symbol | Conditions | min. | typ. | max. | Unit |
|---------------|---|---------------------------|-------|-------|------------------|
| IGBT | | | | | |
| $V_{CE(sat)}$ | $I_C = 150\text{ A}$ $V_{GE} = 15\text{ V}$ chiplevel | $T_j = 25^\circ\text{C}$ | 1.85 | 2.30 | V |
| | | $T_j = 150^\circ\text{C}$ | 2.25 | 2.55 | V |
| V_{CE0} | | $T_j = 25^\circ\text{C}$ | 0.94 | 1.04 | V |
| | | $T_j = 150^\circ\text{C}$ | 0.88 | 0.98 | V |
| r_{CE} | $V_{GE} = 15\text{ V}$ | $T_j = 25^\circ\text{C}$ | 6.07 | 8.4 | $\text{m}\Omega$ |
| | | $T_j = 150^\circ\text{C}$ | 9.13 | 10.47 | $\text{m}\Omega$ |
| $V_{GE(th)}$ | $V_{GE} = V_{CE}, I_C = 6\text{ mA}$ | 5.5 | 6 | 6.5 | V |
| I_{CES} | $V_{GE} = 0\text{ V}$ $V_{CE} = 1200\text{ V}$ | $T_j = 25^\circ\text{C}$ | 0.1 | 0.3 | mA |
| | | $T_j = 150^\circ\text{C}$ | | | mA |
| C_{ies} | $V_{CE} = 25\text{ V}$ | | 9 | | nF |
| C_{oes} | $V_{GE} = 0\text{ V}$ | | 0.89 | | nF |
| C_{res} | | | 0.884 | | nF |
| Q_G | $V_{GE} = -8\text{ V} \dots +15\text{ V}$ | | 1650 | | nC |
| R_{Gint} | | | 5.0 | | Ω |
| $t_{d(on)}$ | $V_{CC} = 600\text{ V}$ $I_C = 150\text{ A}$ | | 320 | | ns |
| t_r | $V_{GE} = \pm 15\text{ V}$ | | 45 | | ns |
| E_{on} | $R_{Gon} = 4\ \Omega$ | | 10 | | mJ |
| $t_{d(off)}$ | $R_{Goff} = 4\ \Omega$ | | 550 | | ns |
| t_f | $di/dt_{on} = 6100\text{ A}/\mu\text{s}$ | | 72 | | ns |
| E_{off} | $di/dt_{off} = 1700\text{ A}/\mu\text{s}$ | | 16.5 | | mJ |
| | $du/dt_{off} = 7800\text{ V}/\mu\text{s}$ | $T_j = 150^\circ\text{C}$ | | | |
| $R_{th(j-c)}$ | per IGBT | | | 0.2 | K/W |

SKM150GB12VG



SEMITRANS® 3

SKM150GB12VG

Features

- V-IGBT = 6. Generation Trench V-IGBT (Fuji)
- CAL4 = Soft switching 4. Generation CAL-diode
- Isolated copper baseplate using DBC technology (Direct Copper Bonding)
- UL recognized, file no. E63532
- Increased power cycling capability
- With integrated gate resistor
- Low switching losses at high di/dt

Typical Applications*

- AC inverter drives
- UPS
- Electronic welders

Remarks

- Case temperature limited to $T_c = 125^\circ\text{C}$ max, recomm.
 $T_{op} = -40 \dots +150^\circ\text{C}$, product rel. results valid for $T_j = 150^\circ$

| Characteristics | | | | | | |
|----------------------|--|---------------------------|------|------|-------|---------------|
| Symbol | Conditions | | min. | typ. | max. | Unit |
| Inverse diode | | | | | | |
| $V_F = V_{EC}$ | $I_F = 150\text{ A}$ $V_{GE} = 0\text{ V}$ chip | $T_j = 25^\circ\text{C}$ | | 2.17 | 2.49 | V |
| | | $T_j = 150^\circ\text{C}$ | | 2.11 | 2.42 | V |
| V_{F0} | | $T_j = 25^\circ\text{C}$ | | 1.3 | 1.5 | V |
| | | $T_j = 150^\circ\text{C}$ | | 0.9 | 1.1 | V |
| r_F | | $T_j = 25^\circ\text{C}$ | | 5.8 | 6.6 | m Ω |
| | | $T_j = 150^\circ\text{C}$ | | 8.1 | 8.8 | m Ω |
| I_{RRM} | $I_F = 150\text{ A}$ $di/dt_{off} = 4000\text{ A}/\mu\text{s}$ $V_{GE} = \pm 15\text{ V}$ $V_{CC} = 600\text{ V}$ | $T_j = 150^\circ\text{C}$ | | 170 | | A |
| Q_{rr} | | $T_j = 150^\circ\text{C}$ | | 22 | | μC |
| E_{rr} | | $T_j = 150^\circ\text{C}$ | | | 11 | |
| $R_{th(j-c)}$ | per diode | | | | 0.31 | K/W |
| Module | | | | | | |
| L_{CE} | | | | 15 | 20 | nH |
| $R_{CC'+EE'}$ | terminal-chip | $T_c = 25^\circ\text{C}$ | | 0.25 | | m Ω |
| | | $T_c = 125^\circ\text{C}$ | | 0.5 | | m Ω |
| $R_{th(c-s)}$ | per module | | | 0.02 | 0.038 | K/W |
| M_s | to heat sink M6 | | | 3 | 5 | Nm |
| M_t | | to terminals M6 | | 2.5 | 5 | Nm |
| | | | | | | Nm |
| w | | | | | 325 | g |

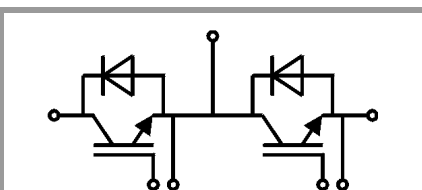

GB

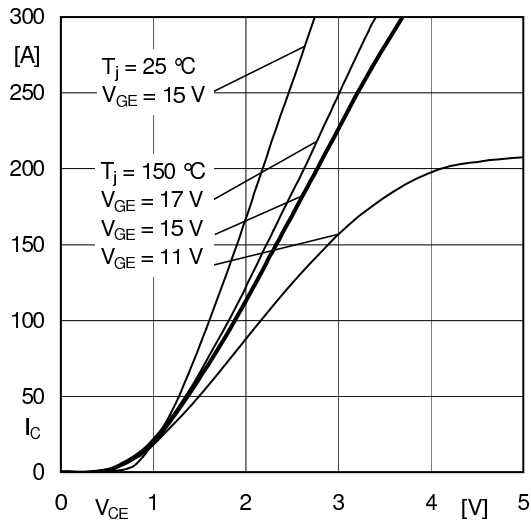

Fig. 1: Typ. output characteristic, inclusive R_{CC+EE}

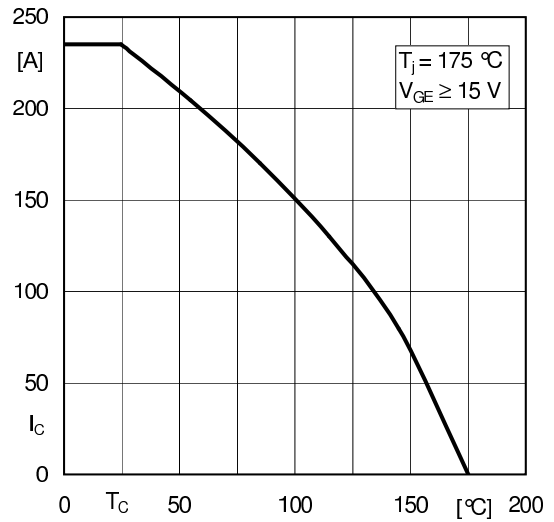

Fig. 2: Rated current vs. temperature $I_C = f(T_C)$

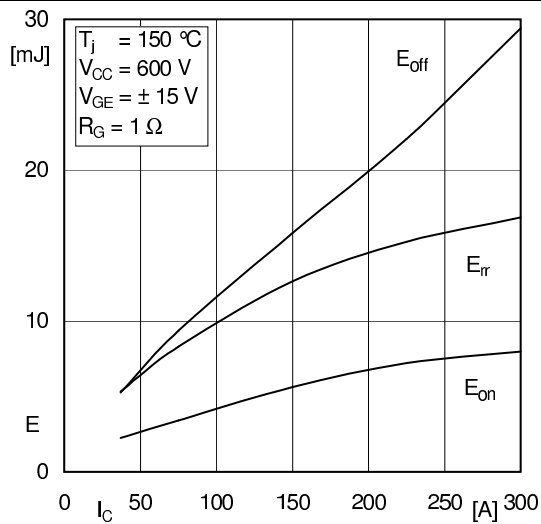

Fig. 3: Typ. turn-on /-off energy = $f(I_C)$

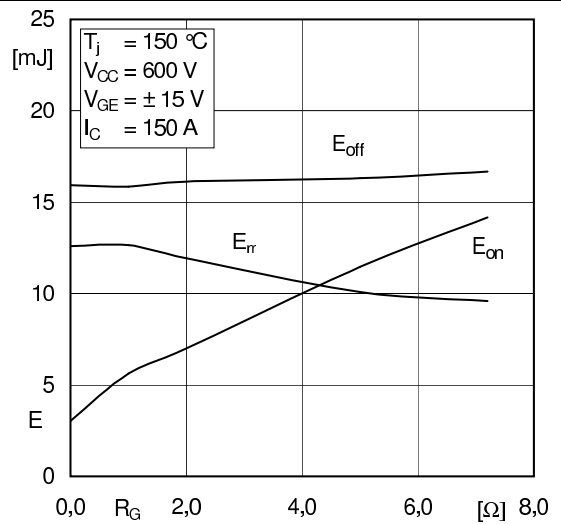

Fig. 4: Typ. turn-on /-off energy = $f(R_G)$

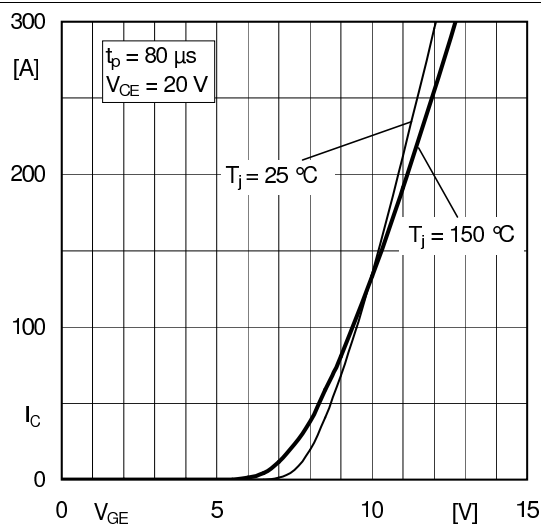

Fig. 5: Typ. transfer characteristic

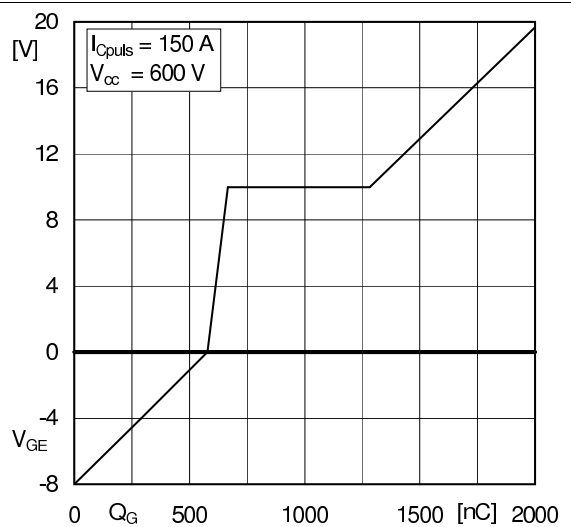

Fig. 6: Typ. gate charge characteristic

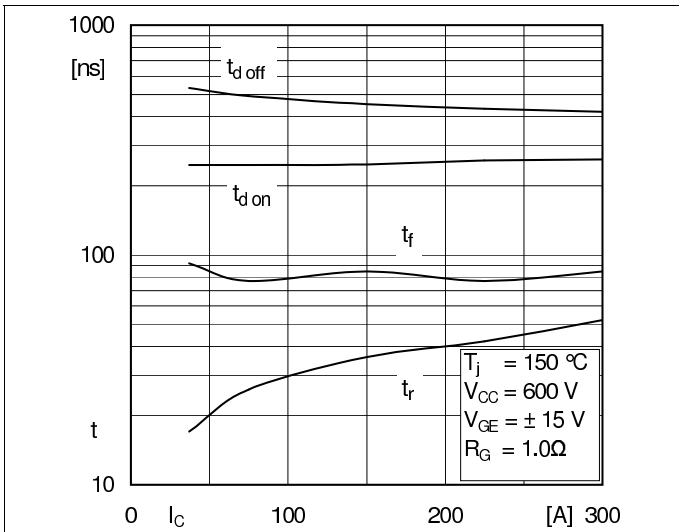

Fig. 7: Typ. switching times vs. I_C

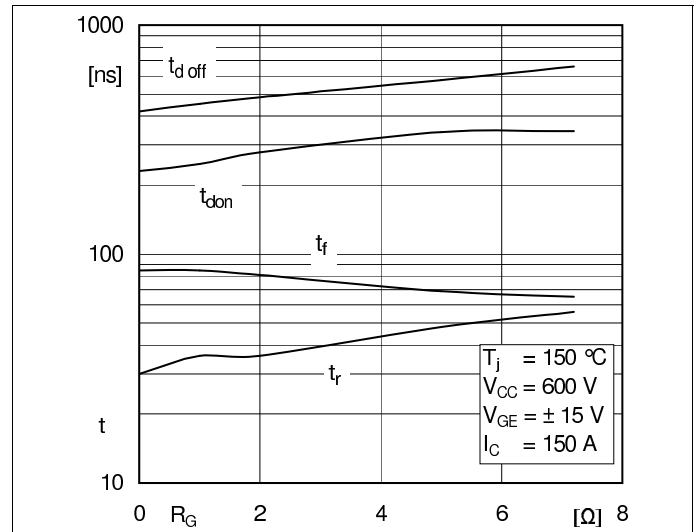

Fig. 8: Typ. switching times vs. gate resistor R_G

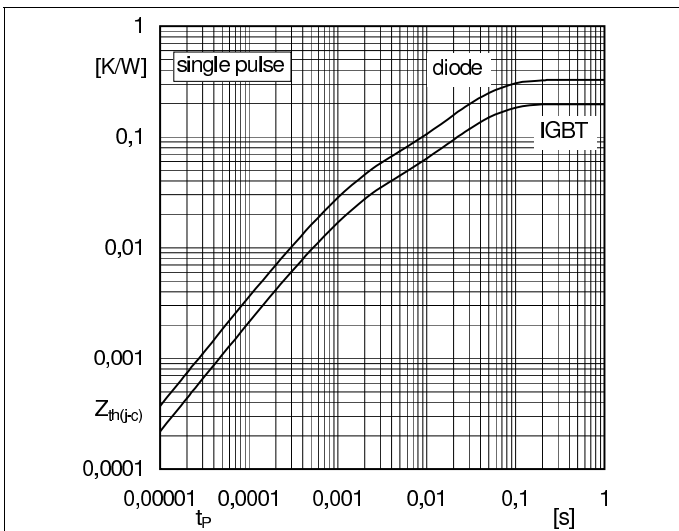

Fig. 9: Transient thermal impedance

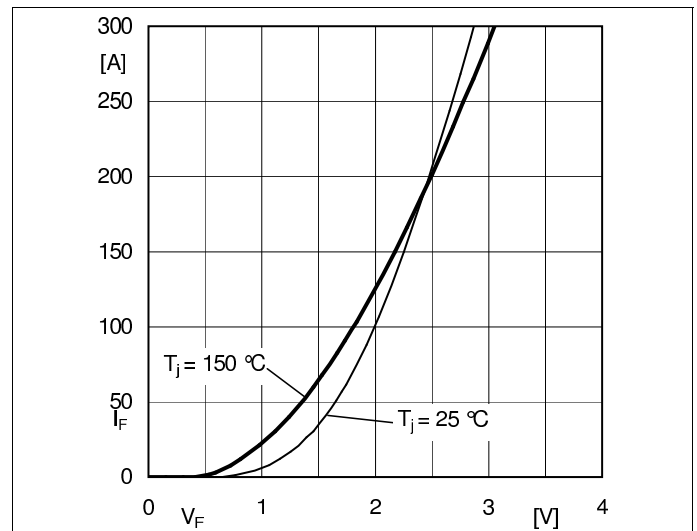

Fig. 10: Typ. CAL diode forward charact., incl. R_{CC+EE}

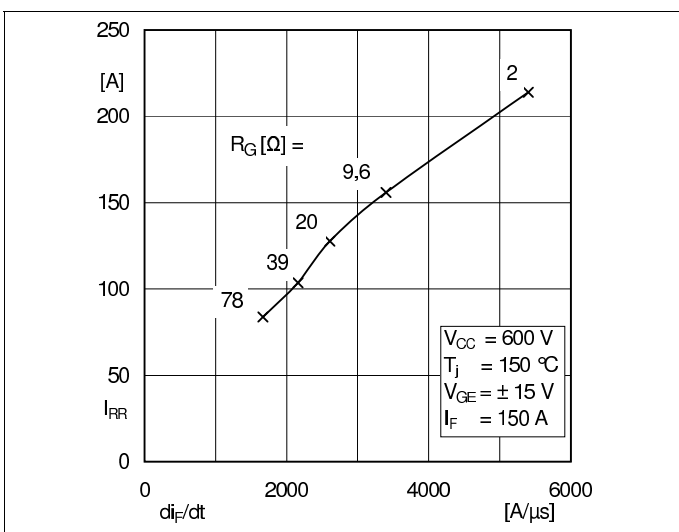

Fig. 11: CAL diode peak reverse recovery current

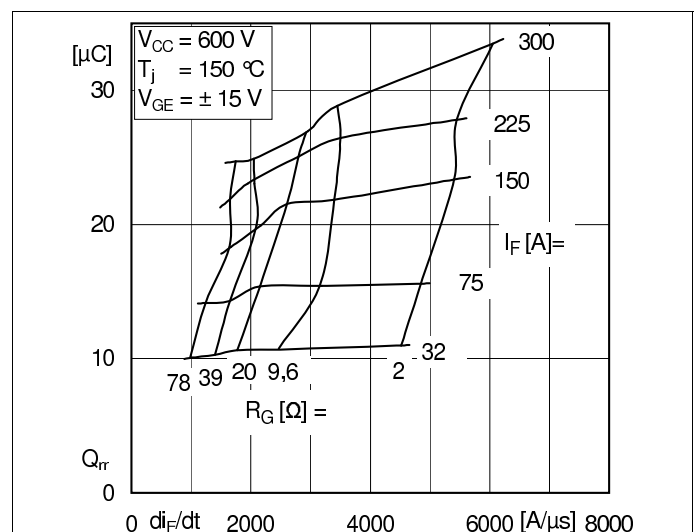
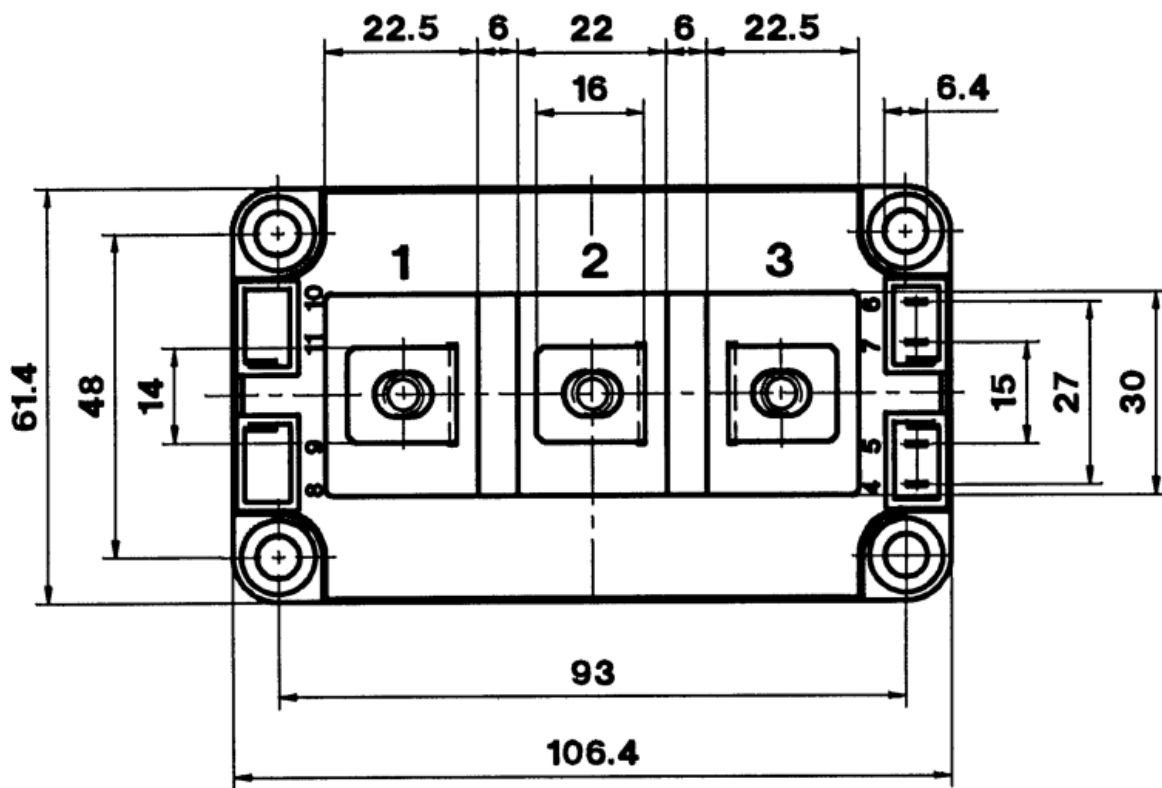
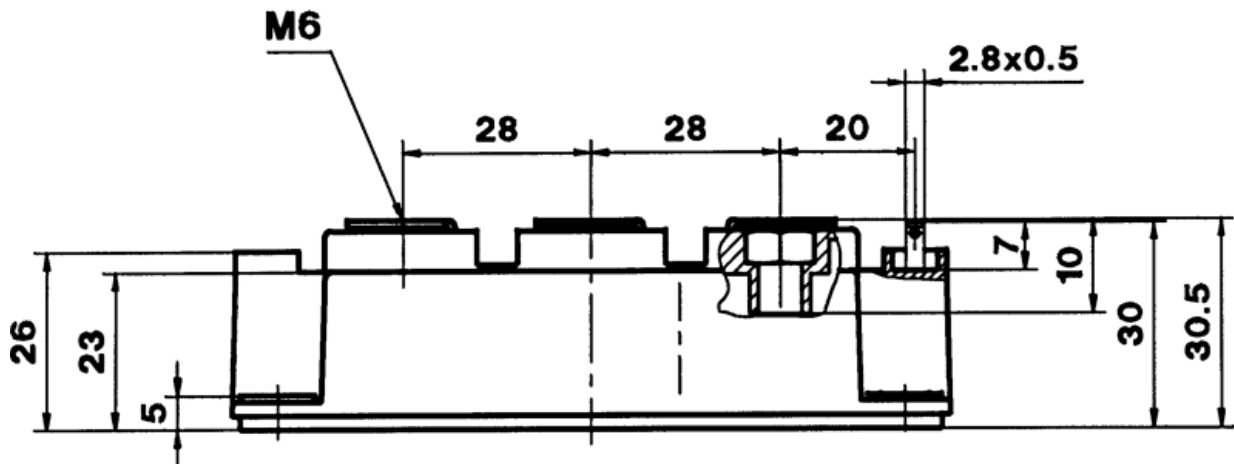
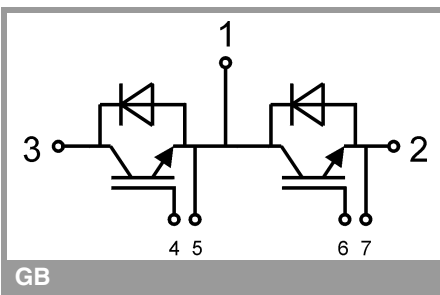

Fig. 12: Typ. CAL diode peak reverse recovery charge



SEMITRANS 3



GB

This is an electrostatic discharge sensitive device (ESDS), international standard IEC 60747-1, Chapter IX

* The specifications of our components may not be considered as an assurance of component characteristics. Components have to be tested for the respective application. Adjustments may be necessary. The use of SEMIKRON products in life support appliances and systems is subject to prior specification and written approval by SEMIKRON. We therefore strongly recommend prior consultation of our staff.