



# 1 Device Overview

## 1.1 Introduction

Freescale Semiconductor's MPR083 proximity capacitive touch sensor controller is one of a family of products designed to detect the state of capacitive touch pads. The MPR083 offers designers a cost-efficient alternative to mechanical rotary switches for control panel applications.

The MPR083 uses an I<sup>2</sup>C interface to communicate with the host which configures the operation and an interrupt to advise the host of status changes. The MPR083 includes a piezo sounder drive which provides audible feedback to simulate mechanical key clicks. The MPR08X family has several implementations to use in your design including control panels and switch replacements. The MPR083 controls rotary and linear sliders. Other members of the MPR08X family are well suited for other application interface situations such as individual touch pads or rotary/touch pad combinations.

Freescale offers a broad portfolio of proximity sensors for products ranging from appliance control panels to portable electronics. Target markets include consumer, appliance, industrial, medical and computer peripherals.

### 1.1.1 Devices in the MPR08X series

The MPR08X series of Proximity Capacitive Touch Sensor Controllers allows for a wide range of applications and implementations. Each of the products in [Table 1](#) perform a different application specific task and are optimized for this specific functionality.

**Table 1. MPR08X family Overview**

Product	Bus	Sounder	Rotary/Slider	Touch Pad Array
MPR083	I <sup>2</sup> C	Yes	8-positions	—
MPR084	I <sup>2</sup> C	Yes	—	8 keys

### 1.1.2 Internal Block Diagram

The MPR083 consists of primary functional blocks; Interrupt Controller, I<sup>2</sup>C Serial Interface, Sounder Controller, Configuration and Status registers, Rotary Position Decoder, Magnitude Comparator and Recalibrator, EMI Burst/Noise Rejection Filter, Capacitance Measurement Analog Front End. Each of these blocks will be described in detail in their respective sections.

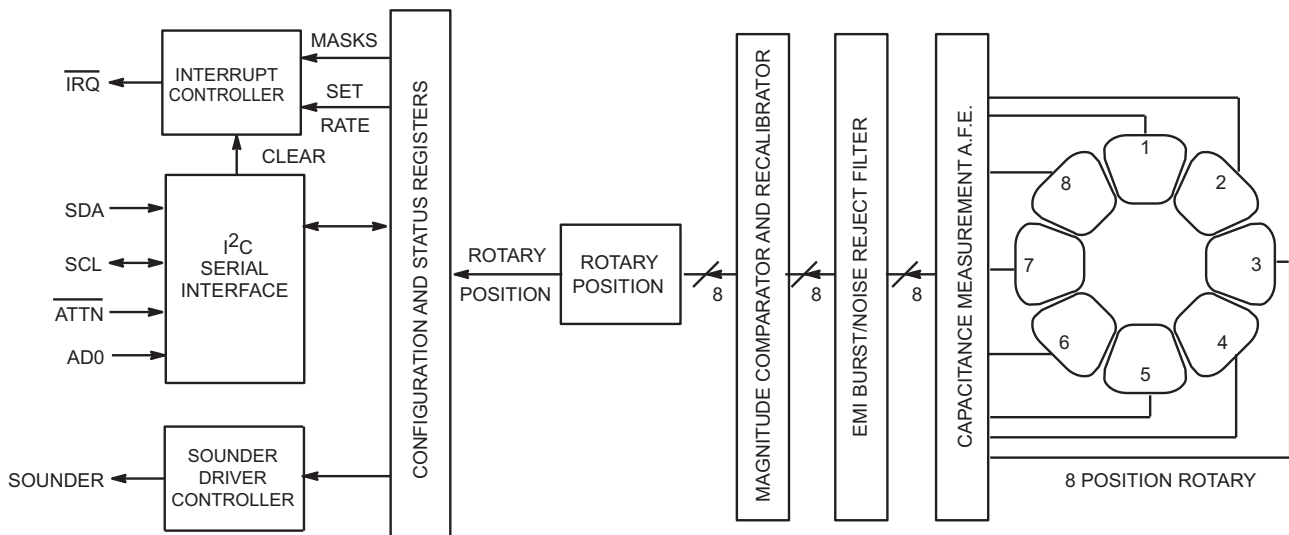

**Figure 2. Functional Block Diagram**



## 2 External Signal Description

### 2.1 Device Pin Assignment

Table 3 shows the pin assignment for the MPR083. For a more detailed description of the functionality of each pin, refer to the appropriate chapter.

**Table 3. Device Pin Assignment**

Pin	Name	Function
1	ATTN	Attention Pin. Input, active low when asserted sets the Configuration Register's $\overline{DCE}$ bit high allowing communication with the part.
2	$\overline{IRQ}$	Interrupt Request Pin. Output, active-low, open-drain interrupt request signaling new events.
3	VDD	Positive Supply Voltage
4	VSS	Ground
5	SCL	I <sup>2</sup> C Serial Clock
6	SDA	I <sup>2</sup> C Serial Data
7	AD0	Address input. Low = slave address 0x4C. High = slave address 0x4D.
8	SOUNDER	Sounder driver output. Connect a piezo sounder from this output to ground. Output is push-pull
9 - 16	E1, E2, E3, E4, E5, E6, E7, E8	Rotary Electrode connections.
PAD	Exposed pad	Exposed pad on package underside (QFN only). Connect to VSS.

The two packages available for the MPR083 are a 5x5mm 16 pin QFN and a 4x5mm 16 pin TSSOP. Both of the packages and their respective pinouts are shown in Figure 3.

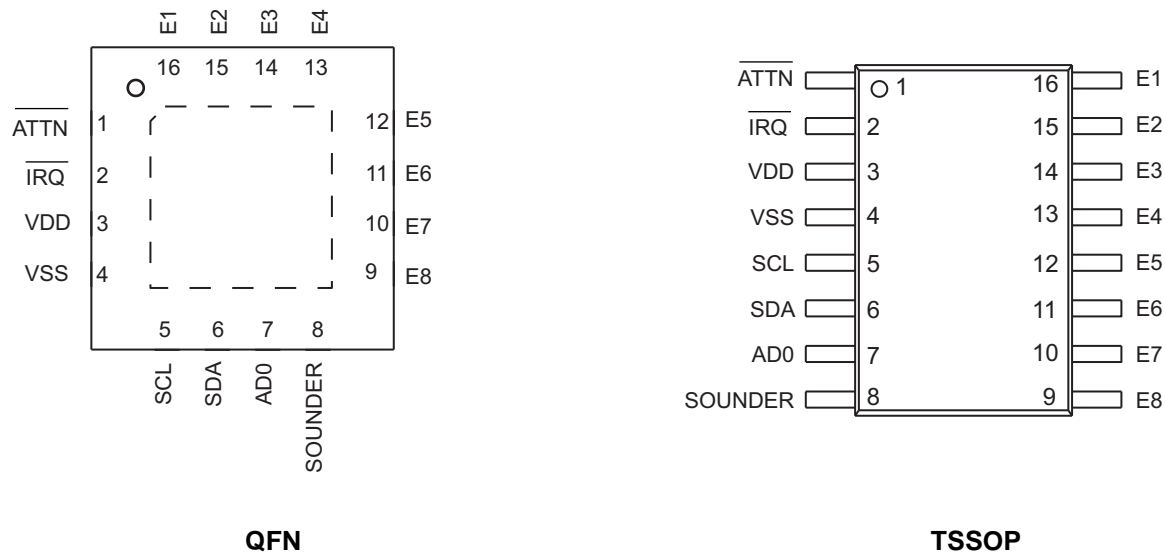

**Figure 3. Package Pinouts**

### 2.2 Recommended System Connections

The MPR083 Capacitive Touch Sensor Controller requires ten external passive components. When connecting the MPR083 in a touch sensor system, the electrode lines must have pull-up resistors. The recommended value for these pull-ups is 780k $\Omega$ . Some electrode arrays will require higher or lower values depending on the application.

In addition to the 8 resistors, a bypass capacitor of 1 $\mu$ F should always be used between the VDD and VSS lines and a 4.7  $\Omega$ k pull-up resistor should be included on the IRQ.



### 2.3.2 Start and Stop Conditions

Both SCL and SDA remain high when the interface is not busy. A master signals the beginning of a transmission with a START (S) condition by transitioning SDA from high to low while SCL is high. When the master has finished communicating with the slave, it issues a STOP (P) condition by transitioning SDA from low to high while SCL is high. The bus is then free for another transmission.

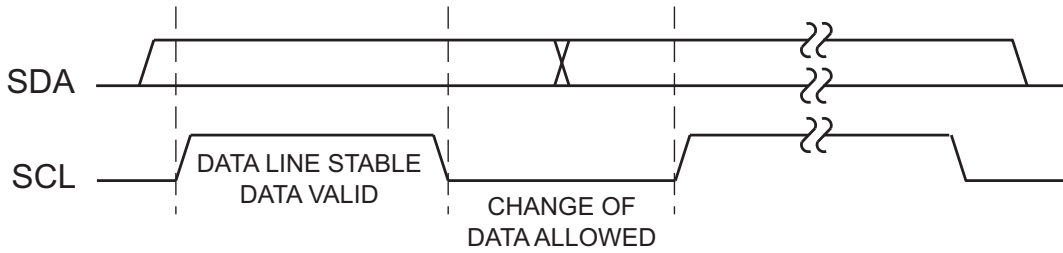

Figure 6. Start and Stop Conditions

### 2.3.3 Bit Transfer

One data bit is transferred during each clock pulse (Figure 7). The data on SDA must remain stable while SCL is high.

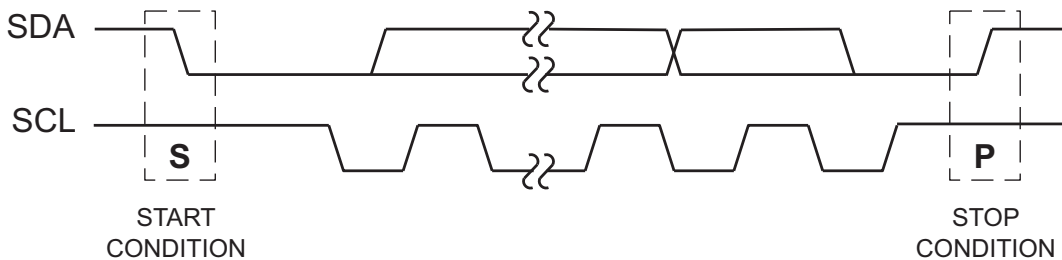

Figure 7. Bit Transfer

### 2.3.4 Acknowledge

The acknowledge bit is a clocked 9<sup>th</sup> bit (Figure 8) which the recipient uses to handshake receipt of each byte of data. Thus each byte transferred effectively requires 9 bits. The master generates the 9<sup>th</sup> clock pulse, and the recipient pulls down SDA during the acknowledge clock pulse, such that the SDA line is stable low during the high period of the clock pulse. When the master is transmitting to the MPR083, the MPR083 generates the acknowledge bit because the MPR083 is the recipient. When the MPR083 is transmitting to the master, the master generates the acknowledge bit because the master is the recipient.

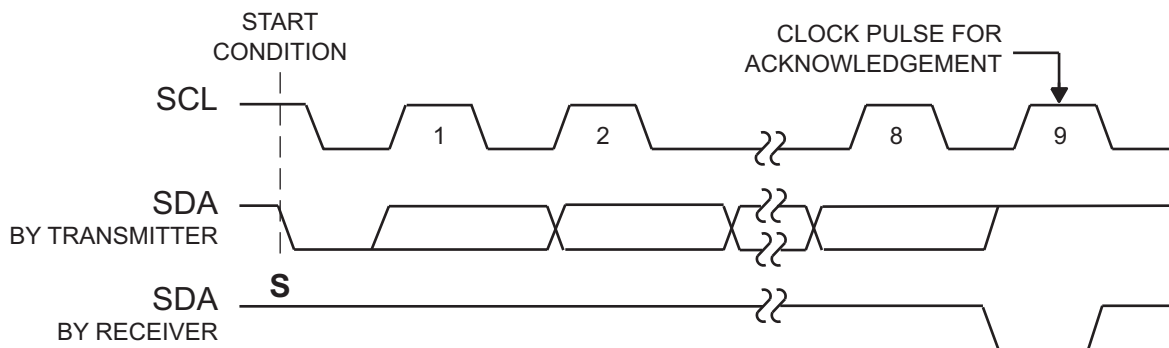

Figure 8. Acknowledge

### 2.3.5 The Slave Address

The MPR083 has a 7-bit long slave address (Figure 9). The bit following the 7-bit slave address (bit eight) is the  $\overline{R/\overline{W}}$  bit, which is low for a write command and high for a read command.

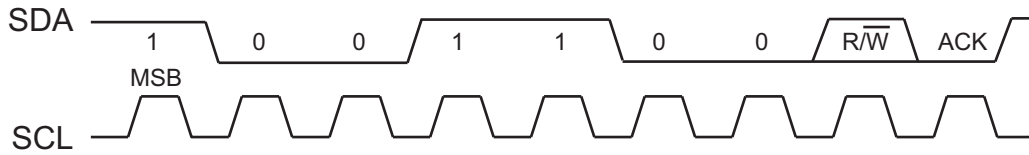

Figure 9. Slave Address

The MPR083 monitors the bus continuously, waiting for a START condition followed by its slave address. When a MPR083 recognizes its slave address, it acknowledges and is then ready for continued communication.

### 2.3.6 Message Format for Writing the MPR083

A write to the MPR083 comprises the transmission of the MPR083's keystore slave address with the  $\overline{R/\overline{W}}$  bit set to 0, followed by at least one byte of information. The first byte of information is the command byte. The command byte determines which register of the MPR083 is to be written by the next byte, if received. If a STOP condition is detected after the command byte is received, then the MPR083 takes no further action (Figure 10) beyond storing the command byte. Any bytes received after the command byte are data bytes.

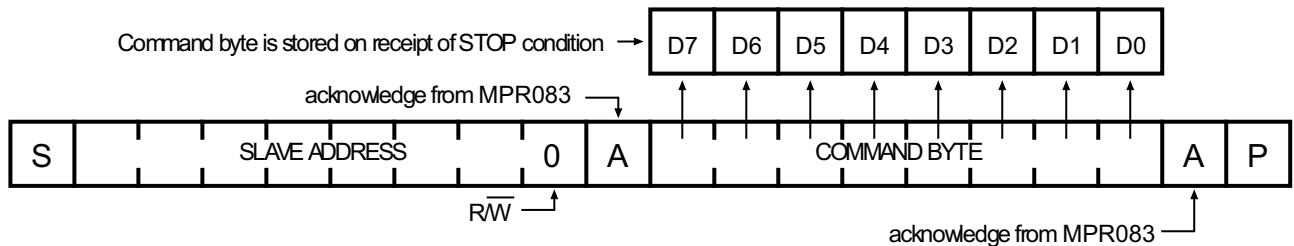

Figure 10. Command Byte Received

Any bytes received after the command byte are data bytes. The first data byte goes into the internal register of the MPR083 selected by the command byte (Figure 11).

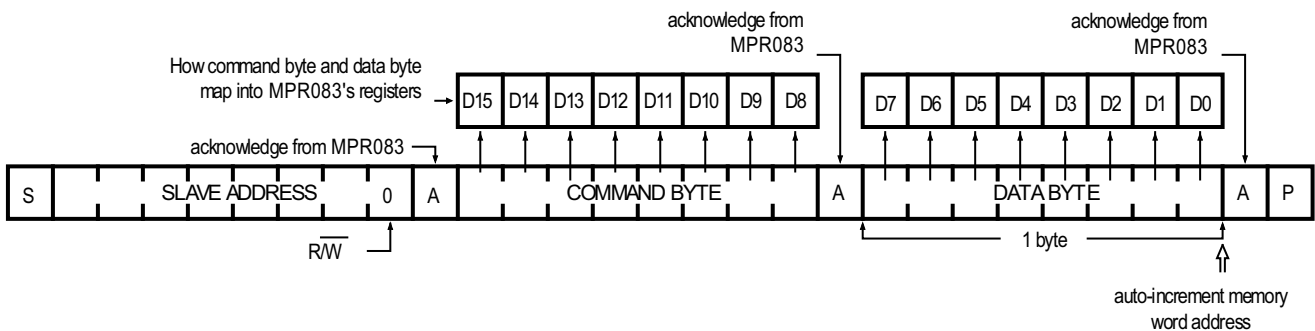

Figure 11. Command and Single Data Byte Received

If multiple data bytes are transmitted before a STOP condition is detected, these bytes are generally stored in subsequent MPR083 internal registers because the command byte address generally auto-increments (Section 2.4).

### 2.3.7 Message Format for Reading the MPR083

The MPR083 is read using the MPR083's internally stored command byte as address pointer, the same way the stored command byte is used as address pointer for a write. The pointer generally auto-increments after each data byte is read using the same rules as for a write (Section 6.4.1). Thus, a read is initiated by first configuring the MPR083's command byte by performing a write (Figure 12). The master can now read 'n' consecutive bytes from the MPR083, with the first data byte being read from the register addressed by the initialized command byte.

When performing read-after-write verification, remember to re-set the command byte's address because the stored command byte address will generally have been auto-incremented after the write (Section 2.4).

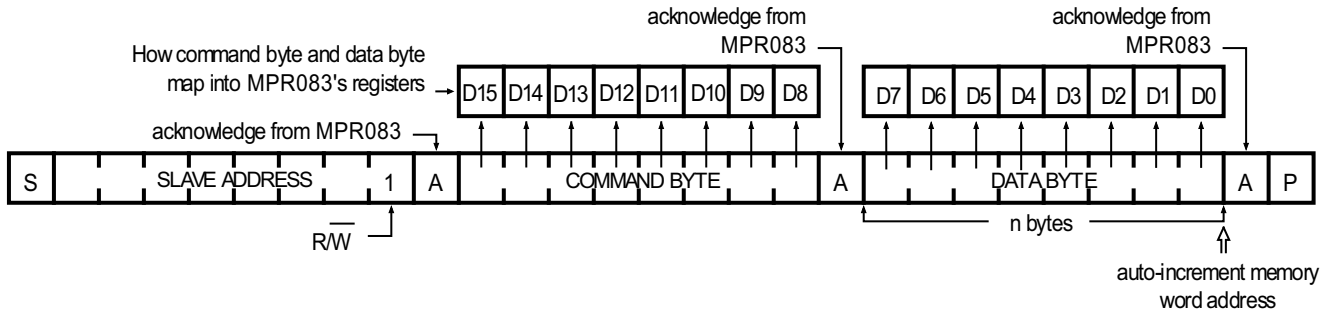

Figure 12. ‘n’ Data Bytes Received

### 2.3.8 Operation with Multiple Master

The application should use repeated starts to address the MPR083 to avoid bus confusion between I<sup>2</sup>C masters. On an I<sup>2</sup>C bus, once a master issues a start/repeated start condition, that master owns the bus until a stop condition occurs. If a master that does not own the bus attempts to take control of that bus, then improper addressing may occur. An address may always be rewritten to fix this problem. Follow I<sup>2</sup>C protocol for multiple master configurations.

### 2.3.9 Device Reset

The  $\overline{RST}$  is an active-low software reset. This is implemented in the Configuration Register by activating the  $\overline{RST}$  bit. When asserted, the device clears any transaction to or from the MPR083 on the serial interface and configures the internal registers to the same state as a power-up reset (Table 4). The MPR083 then waits for a START condition on the serial interface.

The sensor controller is capable of operating down to 1.8 V, however, in order for the sensor controller to exit reset and startup correctly the host system must initially provide 2.0 V to 3.6 V input to  $V_{DD}$  and then follow the process in Figure 13. This process is required in applications that require regulated operation in the 1.8 V to 2.0 V range. In the case that the application uses an unregulated battery, then the battery must initially provide at least 2.0 V to correctly power-up the sensor controller which limits battery selection to the 2.0 V to 3.6 V range.

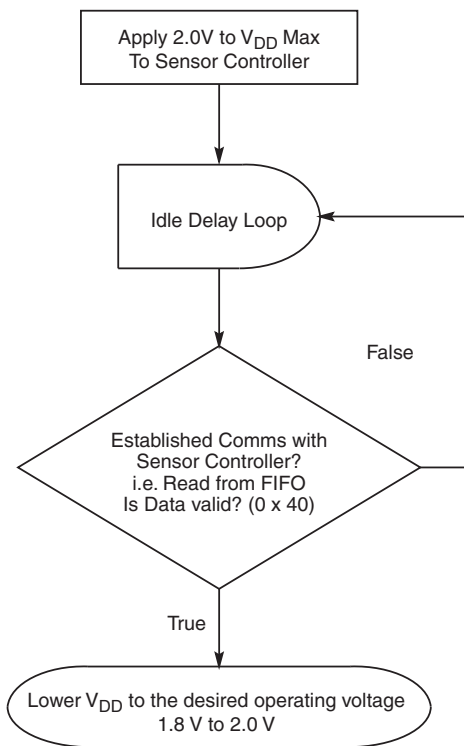

Figure 13. Low Voltage (1.8 V - 2.0 V) Power-up Sequence



## 2.4 Register Address Map

The MPR083 is a peripheral that is controlled and monitored through a small array of internal registers which are accessed through the I<sup>2</sup>C bus. When communicating with the MPR083 each of the registers in [Table 4](#) are used for specific tasks. The functionality of each specific register is detailed in the following sections.

**Table 4. Register Address Map**

Register	Register Address	Burst Mode Auto-Increment Address
FIFO Register	0x00	0x00
Fault Register	0x01	0x02
Rotary Status Register	0x02	0x00
Rotary Configuration Register	0x03	0x04
Sensitivity Threshold Register	0x04	0x05
Master Tick Period Register	0x05	0x06
Touch Acquisition Sample Period Register	0x06	0x07
Sounder Configuration Register	0x07	0x08
Low Power Configuration Register	0x08	0x09
Stuck Key Timeout Register	0x09	0x0A
Configuration Register	0x0A	0x00
Sensor Information Register	0x0B	0x0B

### 3 Touch Detection

#### 3.1 Introduction

When using a capacitive touch sensor system the raw data must be filtered and interpreted. This process can be done many different ways but the method used in the MPR083 is explained in this chapter.

#### 3.2 Understanding the Basics

The rotary interface has to distinguish touch status through varying user conditions (different finger sizes in bare hands or gloves) and environmental conditions (electrical and RF noise, sensor contamination with dirt or moisture).

The rotary circuitry reports touch status as one of the following two conditions:

1. Rotary untouched
2. Rotary touched in one of eight positions.

The rotary is only touched in one position, ideally near the middle of one of the eight pads. If a touch occurs between pads, untouched will be reported.

#### 3.3 Conditional Output Scenarios

Since it is unlikely that in a real world case a single independent touch will occur two specific multi-touch response cases are outlined. Methods for changing the sensitivity of the device will be discussed in another Chapter, but the important part is that the sensitivity is determined by the strength of an input signal. If more than one input signal is above the selected sensitivity then the touch sensor controller interprets this in a specific way. This functionality is broken down into two different cases.

##### 3.3.1 Simultaneous Touches

Any time two touches are detected at the same time the touch sensor controller recognizes this case and accounts for it. Any time more than one key is pressed the touches are ignored. Thus the touch sensor controller will show the rotary as untouched.

In most cases one of the two electrodes will receive a stronger signal than the other. If the difference in capacitance is statistically significant between the pad with the stronger signal will be reported.

This functionality is sometimes called 1-Key Lockout.

##### 3.3.2 Sequential Touches

Another case is when one rotary pad is touched and held and a second rotary pad is then touched and held. For this situation the second touch will be ignored and the first touch will continue to be reported.

If the second touch is released before the first touch then the second touch will be completely ignored. But, if the first touch is released before the second then the system will report that the first key is released and that the second key is now touched. This functionality is sometimes called 2-Key Rollover.

#### 3.4 Rotary Configuration Register

The Rotary Configuration Register configures a variety of the MPR083 features. Each of these features is described in following sections. The I<sup>2</sup>C slave address of the Rotary Configuration Register is 0x03.

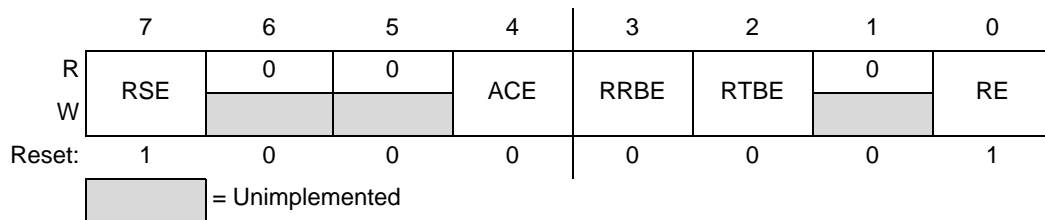

Figure 14. Rotary Configuration Register

**Table 5. Rotary Configuration Register Field Descriptions**

Field	Description
7 RSE	Rotary Sounder Enable – The Rotary Sounder Enable bit controls if data is sent to the sounder. 0 Disable – Click Feedback Off 1 Enable – Click Feedback On
4 ACE	Auto Calibration Enable – The Auto Calibration Enable bit enables or disables the auto calibration function. 0 Disable 1 Enable
3 RRBE	Rotary Release Buffer Enable – The Rotary Release Buffer Enable bit determines whether or not data is logged in the FIFO when the rotary transitions from a touched to untouched state. 0 Disable – No Release Data Logged 1 Enable – Release Data Logged
2 RTBE	Rotary Touch Buffer Enable – The Rotary Touch Buffer Enable bit determines whether or not data is logged in the FIFO any time a button is pressed. 0 Disable – Touches are not logged 1 Enable – Touches are logged
0 RE	Rotary Enable – The Rotary Enable bit enables or disables the touch sensor. When disabled, no touches are detected. 0 Disable – Touches not detected 1 Enable – Touches detected

### 3.5 Touch Acquisition Sample Period Register

The Touch Acquisition Sample Period Register is used to determine the electrode scan period of the system. The I<sup>2</sup>C slave address of the Touch Acquisition Sample Period Register is 0x06.

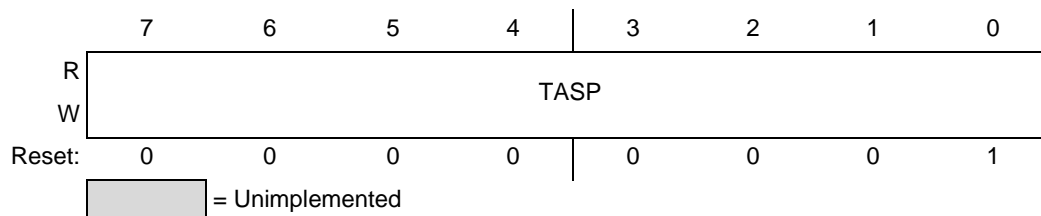
**Figure 15. Touch Acquisition Sample Period Register**
**Table 6. Touch Acquisition Sample Register Field Description**

Field	Description
7:0 TASP	Touch Acquisition Sample Period – The Touch Acquisition Sample Period Field selects or reports the multiplication factor that is used to determine how often electrodes are scanned. The resulting factor must be in the range 1 to 32. If the value is outside of this range the TASP will be set to 00011111. 00000000 Encoding 0 – Sets the TASP multiplication factor to 1 ~ 00011111 Encoding 31 – Sets the TASP multiplication factor to 32.

## 4 Modes of Operation

### 4.1 Introduction

The operating modes of the MPR083 are described in this section. Implementation and functionality of each mode are described. The Modes of Operation of the MPR083 combine to form a suite of quick response and low power consumption functionality. This is achieved through 2 Run modes and 2 Stop Modes. The two modes are enabled by toggling the Configuration Register's  $\overline{DCE}$  and RUNE bits as shown in Table 7. Note that while in a run mode, the only register that can be written to is the Configuration Register. Thus, when changes to registers are needed, enter Stop1 mode, write to the registers and change the mode to "Run".

Table 7. Mode Enable Register Bits

Mode	RUNE	$\overline{DCE}$
Run1	1	1
Run2	1	0
Stop1	0	1
Stop2	0	0

### 4.2 Initial Power Up

On power-up, the interrupt output  $\overline{IRQ}$  is reset, and  $\overline{IRQ}$  will go high. The registers are reset to the values shown in Table 8.

Table 8. Power-Up Register Configurations

Register Function	Power-Up Condition	Register Address	HEX Value
FIFO Register	FIFO is empty	0x00	0x40
Fault Register	No faults	0x01	0x00
Rotary Status Register	Rotary is untouched	0x02	0x00
Rotary Configuration Register	Rotary is enabled, without interrupts, with sounder enabled and Auto-Cal Disabled	0x03	0x81
Sensitivity Threshold Register	Maximum sensitivity	0x04	0x00
Master Tick Period Register	Master clock period is 10ms	0x05	0x05
Touch Acquisition Sample Period Register	TASP is 1 master tick period	0x06	0x01
Sounder Configuration Register	Sounder is globally enabled, 10ms of 1kHz	0x07	0x01
Low Power Configuration Register	Low Power Mode is disabled	0x08	0x00
Stuck Key Timeout Register	Stuck key detector disabled	0x09	0x00
Configuration Register	Stop1 Mode. $\overline{IRQ}$ is disabled	0x0A	0x14
Sensor Information Register	Fixed SensorInfo based on revision	0x0B	0xFF

### 4.3 Run1 Mode

When in Run1 mode the sensor controller will run continuously. During Run1 all the modules are synchronized by the Master Tick Period. This value can be set by using the Master Tick Period Register as outlined in the following section.

While in this mode all functionality of the MPR083 is enabled; touch detection will occur, and I<sup>2</sup>C communication will be available. This mode is enabled by setting the Configuration Register's RUNE and DCE bits high.

#### 4.3.1 Master Tick Period Register

The Master Tick Period Register is used to set the master tick of this system. All parts of the system are synchronized to this counter. This register is overridden in all modes except for Run1. When not in Run1 mode, the value of this register is ignored and 8ms is used for the primary clock. The I<sup>2</sup>C slave address of the Master Tick Period Register is 0x05.

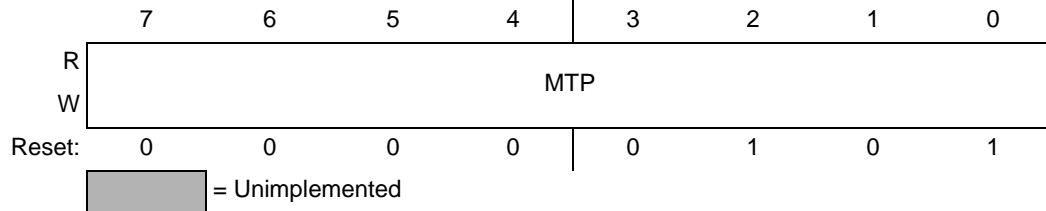

Figure 16. Master Tick Period Register

Table 9. Master Tick Period Register Field Descriptions

Field	Description
7:0 MTP	Master Tick Period – The Master Tick Period selects or reports the current value of the touch sensor controller's primary clock multiplier. The resulting period must be in the range 5ms to 31ms. If the value is outside of this range the MTP will be set to 00011010. 00000000 Encoding 0 – Sets the primary clock multiplier to 5 ~ 00011010 Encoding 26 - Sets the primary clock multiplier to 31

### 4.4 Run2 Mode

When in Run2 mode the sensor controller will continue to scan the electrodes but a low power state will be enabled between each cycle. Because of this, any I<sup>2</sup>C communication that occurs, may or may not respond while the sensor is in this mode.

If  $\overline{DCE}$  is enabled the sensor controller transitions between low power and active states. During the active part of the cycle communication with the sensor controller is possible; however, Freescale always requires users to issue an  $\overline{ATTN}$  signal prior to initiating communications. Accessing the I<sup>2</sup>C interface while DCE mode is enabled without sending an  $\overline{ATTN}$  signal first is likely to produce invalid data.

This mode is enabled by setting the Configuration Register's RUNE bit high and  $\overline{DCE}$  bit low. The only way to exit this mode is to toggle the Attention Pin, refer to Section 4.7.

### 4.5 Stop1 Mode

When in Stop1 mode the sensor controller will not scan the electrodes. While capacitance sensing is disabled I<sup>2</sup>C communications will still be accepted and the sensor controller will maintain instantaneous response to all register requests. This is the only mode in which register values can be set.

This mode is enabled by setting the Configuration Register's RUNE bit low and  $\overline{DCE}$  bit high.

### 4.6 Stop2 Mode

When in Stop2 mode the sensor controller will not scan the electrodes or accept I<sup>2</sup>C communication. The MPR083 is off during this mode.

This mode is enabled by setting the Configuration Register's RUNE bit low and  $\overline{DCE}$  bit low. The only way to exit this mode is to toggle the Attention Pin, refer to Section 4.7.

## 4.7 Configuration Register

The Configuration Register allows a user to reset the part, adjust Interrupt settings, and change the mode. The I<sup>2</sup>C slave address of the Configuration Register is 0x0A.

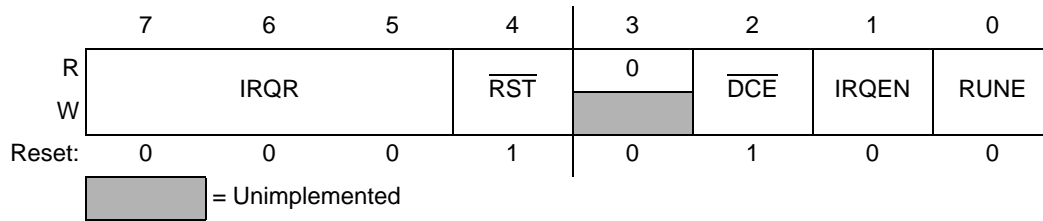

Figure 17. Configuration Register

Table 10. Configuration Register Field Descriptions

Field	Description
7:5 IRQR	Interrupt Rate – The Interrupt Rate Field selects the amount to multiply the MTP by to determine the minimum delay between sequential Interrupts. 000 Encoding 0 – Sets the IRQR multiplication factor to 1 ~ 111 Encoding 7 – Sets the IRQR multiplication factor to 8
4 $\overline{\text{RST}}$	Reset – Asserts a global reset of the sensor controller. 0 Reset Asserted 1 Reset Not Asserted
2 $\overline{\text{DCE}}$	Duty Cycle Enable – The Duty Cycle Enable bit enables or disables duty cycling on the MPR083. This bit is active low. 0 Duty Cycle Enabled (2 modes) 1 Duty Cycle Disabled (1 modes)
1 IRQEN	Interrupt Enable – The Interrupt Enable bit enables or disables the $\overline{\text{IRQ}}$ functionality. 0 $\overline{\text{IRQ}}$ Disabled 1 $\overline{\text{IRQ}}$ Enabled
0 RUNE	Run Mode Enable – The Run Mode Enable bit enables or disables scanning of the electrodes for touch detection. This bit is active high. 0 Electrode Scanning Disabled (Stop modes) 1 Electrode Scanning Enabled (Run modes)

## 4.8 Attention Pin

The Attention ( $\overline{\text{ATTN}}$ ) pin allows a user to externally set the Configuration Register's  $\overline{\text{DCE}}$  bit high. This is latched on a high to low transition. Since the current mode of the device is enabled through the  $\overline{\text{DCE}}$  this will cause duty cycling to be disabled and change the current mode from Run2 to Run1, or Stop2 to Stop1 (depending on the previous state).

When in Run2 or Stop2 modes this is the only way to enable the I<sup>2</sup>C communication.

## 5 Low Power Configuration

### 5.1 Introduction

The MPR083 features a Low Power mode that can reduce the power consumption into the microamps range. This feature can be used to both adjust the response time of the system, and change the conditions on which Low Power would be enabled.

### 5.2 Operation

This Low Power configuration is only active when the sensor controller is in Run2 mode. The Low Power mode decreases current consumption by increasing the response time of the MPR083. This increase is controlled through two factors.

During normal Run2 operation of the sensor controller the Max Response Time (MRT) is calculated by taking the product of the TASP and the primary clock. From Chapter 4 the primary clock is the (MTP + 5) ms. Since the sensor controller is in Run2, the primary clock is also multiplied by a factor of 8. The debounce rate of the MPR083 is 4 times the sample rate thus the MRT is represented by the following equation.

$$MRT_1 = \left( \frac{MTP + 5}{8} + 1 \right) \times TASP \times 4 \times 8ms \quad \text{Equation 1}$$

First, the Idle Interface Timeout (IIT) represents the total time the touch interface should remain idle before going into Low Power mode. This value can be calculated by taking the product of the ITP, TASP and primary clock (8ms) with a factor of 64. Thus the IIT is represented as follows:

$$MRT_2 = \left( \frac{MTP + 5}{8} + 1 \right) \times TASP \times SCD \times 4 \times 8ms \quad \text{Equation 2}$$

Second, the Max Response Time (MRT) represents the total time the touch interface should remain inactive before scanning the electrodes. This value can be calculated by taking the product of the SCD, TASP and primary clock (8ms) with a factor of 5. Thus the MRT is represented as follows:

$$ITT = \left( \frac{MTP + 5}{8} + 1 \right) \times TASP \times ITP \times 6 \times 8ms \quad \text{Equation 3}$$

When in Run2 mode, the sensor controller will initially scan the electrodes at the rate of  $MRT_1$ . When scanning at  $MRT_1$  and the touch interface remains idle for the IIT period then the scan period will change to  $MRT_2$ . When scanning at  $MRT_2$  and a touch is detected the scan rate will transition back to  $MRT_1$ .

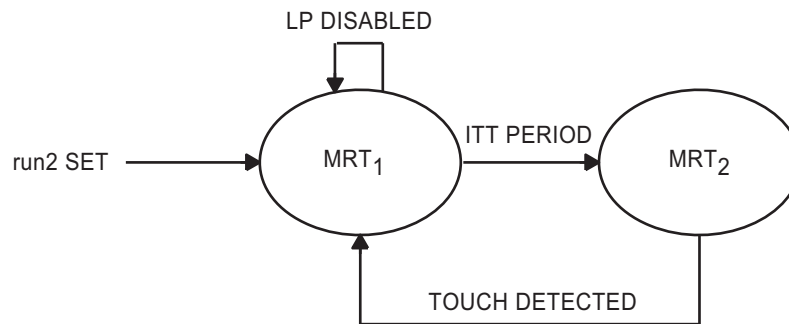

Figure 18. Low Power Scan Period Transition Diagram

### 5.3 Configuration

Low Power Configuration is achieved through setting two values; the Idle Timeout Period and the Sleep Cycle Duration. This functionality is described in the following section.

#### 5.3.1 Low Power Configuration Register

The Low Power Configuration register is used to set both the Idle Timeout Period and Sleep Cycle Duration multiplication factors. The I<sup>2</sup>C slave address of the Low Power Configuration Register is 0x08.

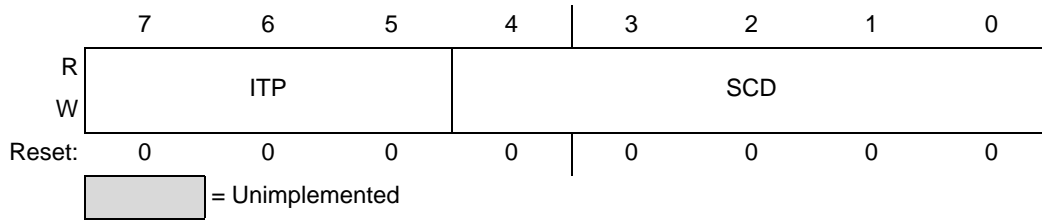

Figure 19. Low Power Configuration Register

Table 11. Low Power Configuration Register Field Descriptions

Field	Description
7:5 ITP	Idle Timeout Period – The Idle Timeout Period selects the amount to multiply the TASP (touch acquisition sample period) by to determine the idle interface timeout (IIT) period of the sensor controller. 000 Encoding 0 – Disables Low Power Mode 001 Encoding 1 – Sets the ITP multiplication factor to 1 ~ 111 Encoding 7 – Sets the ITP multiplication factor to 7
4:0 SCD	Sleep Cycle Duration – The Sleep Cycle Duration Field selects the amount to multiply the TASP (touch acquisition sample period) by to determine the Sleep period of the sensor controller. 00000 Encoding 0 – Disables Low Power Mode 00001 Encoding 1 – Sets the SCD multiplication factor to 1 ~ 11111 Encoding 31 – Sets the SCD multiplication factor to 31





**Table 13. FIFO Register Field Descriptions**

Field	Description
7 MDF	More Data Flag – The More Data Flag shows whether or not data will remain in the buffer after the current read. 0 No Data Remaining 1 Data Remaining
6 NDF	No Data Flag – The No Data Flag shows whether or not there is currently data in the buffer. 0 Buffer currently has data 1 Buffer does not currently have data
5 OF	Overflow Flag – The Overflow Flag shows whether or not an overflow has occurred. If this flag is high then the most current data was lost. 0 No Overflow has occurred 1 Overflow has occurred
4 TRF	Touch Release Flag – The Touch Release Flag shows if the current buffer entry is a touch or release of a pad. 0 Pad is released 1 Pad is touched
3:0 BP	Buffered Position – The Buffered Position represents the electrode number that is currently being displayed by the buffer. 0000 Encoding 0 – Buffered touch of electrode 1 ~ 0111 Encoding 7 – Buffered touch of electrode 8

## 6.4 Error

The MPR083 can generate a fault under two conditions; an electrode is shorted to VDD, or an electrode is shorted to VSS. Once a fault is asserted the sensor electrodes will no longer be scanned until the fault is cleared. In the event of multiple faults occurring at the same time, the sensor controller will report the first fault that is detected during scanning.

### 6.4.1 Fault Register

The Fault Register is a read only register that shows the fault number under the current sensor conditions. Any write to the Fault Register will clear the register, when in Stop mode. The Fault register cannot be cleared when the part is in a Run mode. The I<sup>2</sup>C slave address of the Fault Register is 0x01.

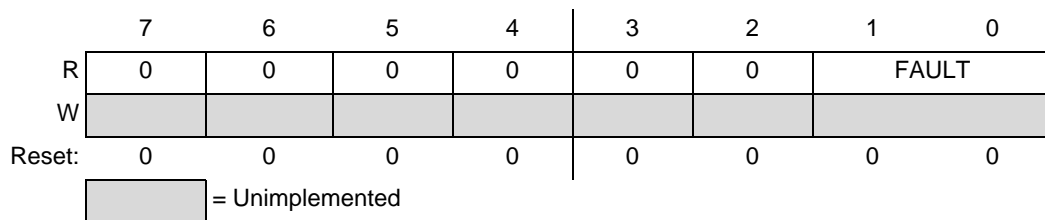
**Figure 22. Fault Register**
**Table 14. Fault Register Field Descriptions**

Field	Description
1:0 FAULT	Fault – The Fault code represents the currently asserted fault condition. 00 Encoding 0 – No fault detected 01 Encoding 1 – Short to VSS detected 10 Encoding 2 – Short to VDD detected

## 7 Interrupts

### 7.1 Introduction

The MPR083 has one interrupt output that is configured by registers and alerts the application when a touch or fault is detected. When running in Run2 or Stop2 mode where I<sup>2</sup>C communication is not available this feature alerts the user to sensor touches.

### 7.2 Condition for Interrupt

There are two cases that latch the Interrupt buffered data available or fault detected.

#### 7.2.1 Buffered Data Available

The interrupt for Buffered Data Available will only trigger when the NDF (No Data Flag) transitions from high to low. This signifies that there is new data available in the buffer. The interrupt is deasserted on the first read/write of the FIFO Register and cannot be reasserted for buffered data until the FIFO is empty (either by reading all the data, or clearing the buffer).

#### 7.2.2 Fault Detected

The interrupt for a fault detected condition is triggered any time the Fault condition in the Fault Register transitions from zero to non-zero. The interrupt is deasserted when the Fault Register is cleared (by writing to the Fault Register).

### 7.3 Settings

Interrupts are configured through I<sup>2</sup>C using the Configuration Register (Section 4.7). Two of the settings in this register will affect the interrupt functionality.

The Interrupt Enable (IRQEN) must be set high for the  $\overline{IRQ}$  to be enabled. When low, all interrupts will be ignored, and the  $\overline{IRQ}$  pin will never latch.

The Interrupt Rate (IRQR) sets the minimum delay between sequential triggered interrupts. The minimum interrupt period can be calculated by taking the product of the (MTP + 5) and IRQR with a factor of 4. Thus, for the minimum setting an interrupt would be triggered no more often than 4 times the master clock.

$$MinInterruptPeriod(ms) = (MTP + 5) \times IRQR \times 4 \quad \text{Equation 4}$$

If the MPR083 is using Run2, the minimum interrupt period would be represented by the following equation.

$$MinInterruptPeriod(ms) = \left( \frac{MTP + 5}{8} + 1 \right) \times 8 \times IRQR \times 4 \quad \text{Equation 5}$$

### 7.4 $\overline{IRQ}$ Pin

The  $\overline{IRQ}$  pin is an open-drain, latching interrupt output which requires an external pull-up resistor. The pin will latch down based on the conditions in Section 6.2. The pin will reset when an I<sup>2</sup>C transmission reads/writes the appropriate register displaying information about the source of the interrupt. Thus if the source is buffered data available then a FIFO Buffer read/write will clear the  $\overline{IRQ}$  pin. If the source is a fault detected then a write of the Fault Register will clear the pin.

## 7.4.1 $\overline{\text{IRQ}}$ Pin Timing

The MinInterruptPeriod is implemented as a hold off of  $\overline{\text{IRQ}}$  latching per Figure 23 and Figure 24. In the first case the MinInterruptPeriod is longer than the interval between sequential interrupt source events, thus it delays the  $\overline{\text{IRQ}}$  from latching until the MinInterruptPeriod has elapsed.

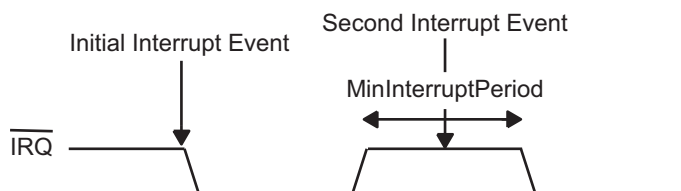

Figure 23.  $\overline{\text{IRQ}}$  Timing Diagram - Case 1

In the second case the MinInterruptPeriod is shorter than the interval between sequential interrupt source events, thus the  $\overline{\text{IRQ}}$  latches as it normally would without additional delay.

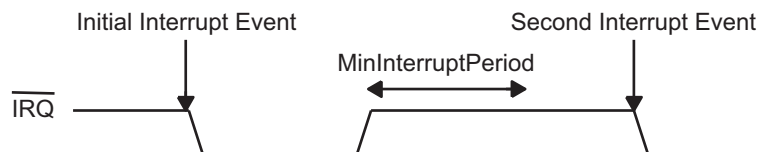

Figure 24.  $\overline{\text{IRQ}}$  Timing Diagram - Case 2

## 8 Calibration

### 8.1 Introduction

The MPR083 is self-calibrating. This is done both at initial start-up of the device and during run time.

### 8.2 Initial Start-up Conditions

Initial calibration of the MPR083 occurs every time the device resets. The first key detection cycle is used as a baseline capacitance value for all remaining calculations. Thus, a touch is detected by taking the difference between this baseline value and the current capacitance on the electrode.

### 8.3 Auto-Calibration

The MPR083 has an auto-calibration feature. This is enabled through the Rotary Configuration Register (Section 3.4), by setting the ACE bit high. Auto calibration is done by two mechanisms. The basic auto-calibration will recalculate the baseline value after 6 sample periods. Thus the auto calibrate period can be calculate by multiplying the master clock period (in milliseconds) and the touch acquisition sample period with a factor of 64.

$$\text{AutoCalibrationPeriod}(ms) = MCP \times TASP \times 64 \quad \text{Equation 6}$$

If a touch is currently being detected the auto-calibration will not engage and calibration will be ignored. The device can also be calibrated when a key is being touched, this is controlled by stuck key detection.

### 8.4 Stuck Key Detection

The Stuck Key Detection system allows the application to specify the maximum amount of time a touch should be detected before it is calibrated into the baseline and the touch is ignored. This is controlled by setting the Stuck Key Timeout multiplication factor (SKT). The timeout period can be calculated by multiplying the SKT, master clock period (in ms) and touch acquisition sample period with a factor of 64.

$$\text{AutoCalibrationPeriod}(ms) = MCP \times TASP \times SKT \times 64 \quad \text{Equation 7}$$

When Stuck Key Detection is off a touched key will remain touched indefinitely and never be calibrated into the baseline value.

#### 8.4.1 Stuck Key Timeout Register

The Stuck Key Timeout Register is used to determine the electrode scan period of the system. The I<sup>2</sup>C slave address of the Stuck Key Timeout Register is 0x09.

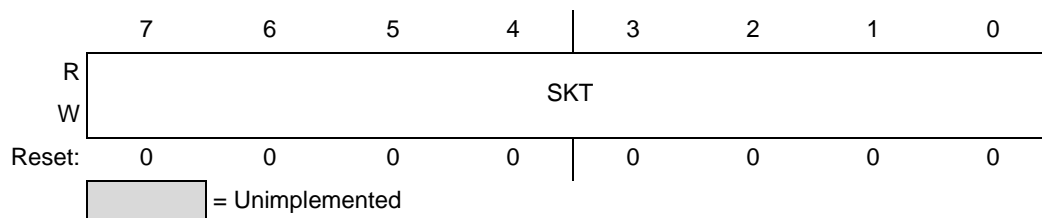

Figure 25. Stuck Key Timeout Register

Table 15. Stuck Key Timeout Register Field Descriptions

Field	Description
7:0 SKT	Stuck Key Timeout – The Stuck Key Timeout field selects or reports the multiplication factor that is used to determine how often electrodes are calibrated while a touch is being detected. 00000000 Encoding 0 – Turns off Stuck Key Detection 00000001 Encoding 1 – Sets the SKT multiplication factor to 2 ~ 11111111 Encoding 255 – Sets the SKT multiplication factor to 256

## 9 Sensitivity

### 9.1 Introduction

The MPR083 can operate in a variety of environments with a variety of different electrode patterns. Because of this it is necessary to adjust the relative sensitivity of the sensor controller. Usually this requires fine tuning in any final application.

There are many factors that must be taken into account, but much of the time this value is relative to the capacitance changes generated by a touch. Since capacitance is directly proportional to the dielectric constant of the material and the area of the pad, while inversely proportional to the distance between pads these are the primary factors.

$$C = \frac{ke_0A}{d} \quad \text{Equation 8}$$

As the relative capacitance rises the sensitivity setting of the MPR083 should be adjusted accordingly. Thus a very high sensitivity value represents a large A and a small d.

### 9.2 Adjusting the Sensitivity

The sensitivity of the MPR083 is adjusted by varying the Sensitivity Threshold Register.

#### 9.2.1 Sensitivity Threshold Register

The sensitivity register allows the sensitivity of the MPR083 to be adjusted for any situation. The I<sup>2</sup>C slave address of the Sensitivity Threshold Register is 0x04.

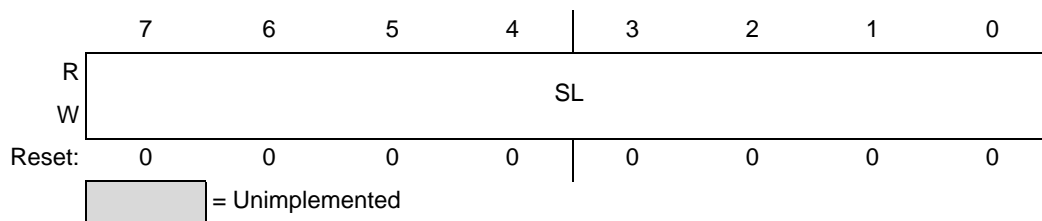

Figure 26. Sensitivity Threshold Register

Table 16. Sensitivity Threshold Register Field Descriptions

Field	Description
7:0 ST	Sensitivity Threshold – The Sensitivity Threshold selects or reports the sensitivity setting of the Sensor Controller. The resulting value must be in the range 1 to 64 units. If the value is outside of this range the ST will be set to 00111111. 00000000 Encoding 0 – Sets the sensitivity to level 1 ~ 00111111 Encoding 63 – Sets the sensitivity to level 64

## 10 Additional Features

### 10.1 Key Click Sound Generator

The Key Click Sound Generator allows the MPR083 to generate audible feedback, independent of the I<sup>2</sup>C communication status. The sounder is used to drive a piezo buzzer. This output is configured by using the Sounder Register, shown in the following section.

#### 10.1.1 Sounder Configuration Register

The I<sup>2</sup>C slave address of the Sounder Configuration Register is 0x07.

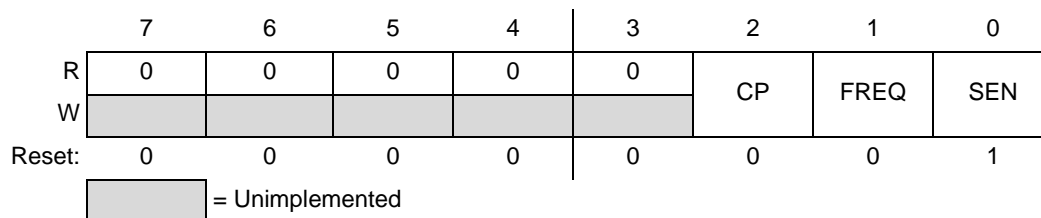

Figure 27. Sounder Configuration Register

Table 17. Sounder Configuration Register Field Descriptions

Field	Description
2 CP	Click Period – The Click Period bit controls the length of the sounder click. 0 Sounder Click Period is 10ms 1 Sounder Click Period is 20ms
1 FREQ	Frequency – The Frequency bit controls the frequency of the driven output. 0 Sounder frequency is 1kHz 1 Sounder frequency is 2kHz
0 SEN	Sounder Enable – The Sounder Enable bit enables or disables the sounder output. 0 Disable 1 Enable

### 10.2 Sensor Information

The Sensor Information register is a read only register that displays a descriptor which contains static information about the MPR083 version.

#### 10.2.1 Sensor Information Register

The I<sup>2</sup>C slave address of the Sensor Information Register is 0x0B.

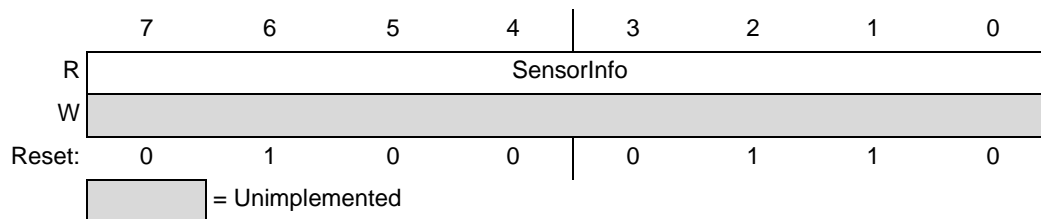

Figure 28. Sensor Information Register

Table 18. Sensor Information Register Field Descriptions

Field	Description
7-0 SensorInfo	SensorInfo – The Sensor Information register describes the version information for the part. Burst reads will display ASCII data in the following format: VENDOR_LABEL",PN:"PRODUCT_LABEL",QUAL:"BUILD_TYPE_LABEL",VER:" BUILD_VERSION_MAJOR"_"BUILD_VERSION_MINOR"_"BUILD_NUMBER"0"





## A.4 DC Characteristics

This section includes information about power supply requirements and I/O pin characteristics.

**Table 21. DC Characteristics (Temperature Range = -40°C to 85°C Ambient)**

(Typical Operating Circuit,  $V_{DD} = 1.8 \text{ V}^*$  to  $3.6 \text{ V}$ ,  $T_A = T_{MIN}$  to  $T_{MAX}$ , unless otherwise noted. Typical Current values are at  $V_{DD} = 3.3 \text{ V}$ ,  $T_A = +25^\circ\text{C}$ .)

Parameter	Symbol	Conditions	Min	Typ	Max	Units
Operating Supply Voltage	$V_{DD}$		1.8*		3.6	V
Run1 mode Current	$I_{run1}$	$V_{DD} = 1.8 \text{ V}$		1.62		mA
Run2 mode Current	$I_{run2}$	$V_{DD} = 1.8 \text{ V}$		41		$\mu\text{A}$
Stop1 mode Current	$I_{stop1}$	$V_{DD} = 1.8 \text{ V}$		1.47		mA
Stop2 mode Current	$I_{stop2}$	$V_{DD} = 1.8 \text{ V}$		2		$\mu\text{A}$
Input High Voltage SDA, SCL	$V_{IH}$		$0.7 \times V_{DD}$			V
Input Low Voltage SDA, SCL	$V_{IL}$				$0.35 \times V_{DD}$	V
Input Leakage Current SDA, SCL	$I_{IH}, I_{IL}$			0.025	1	$\mu\text{A}$
Input Capacitance SDA, SCL					7	pF
Output Low Voltage SDA, IRQ	$V_{OL}$	$I_{OL} = 6\text{mA}$			0.5V	V

\*The MPR083 requires a specific start-up sequence for  $V_{DD} < 2.0 \text{ V}$ . Refer to [Section 2.3.9](#).

## A.5 I<sup>2</sup>C AC Characteristics

This section includes information about I<sup>2</sup>C AC Characteristics.

**Table 22. I<sup>2</sup>C AC Characteristics**

(Typical Operating Circuit,  $V_{DD} = 1.8 \text{ V}$  to  $3.6 \text{ V}$ ,  $T_A = T_{MIN}$  to  $T_{MAX}$ , unless otherwise noted. Typical values are at  $V_{DD} = 3.3 \text{ V}$ ,  $T_A = +25^\circ\text{C}$ .)

Parameter	Symbol	Conditions	Min	Typ	Max	Units
Serial Clock Frequency <sup>(1)</sup>	$f_{SCL}$				100	kHz
Capacitive Load for Each Bus Line	$C_b$				400	pF

1. Clock Stretching is required for reliable communications



**Touch Acquisition Sample Period Register: 0x06**

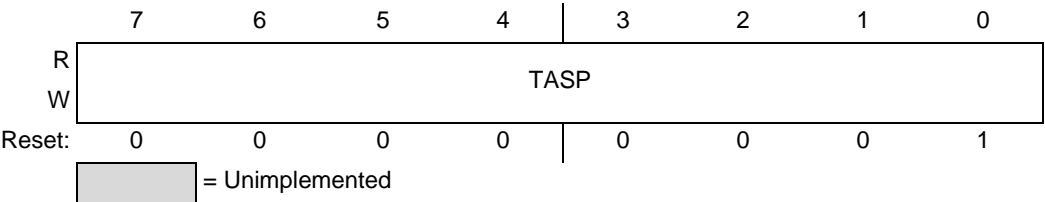

**Sounder Configuration Register: 0x07**

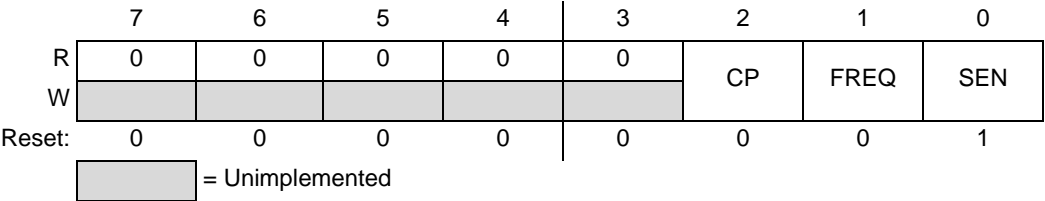

**Low Power Configuration Register: 0x08**

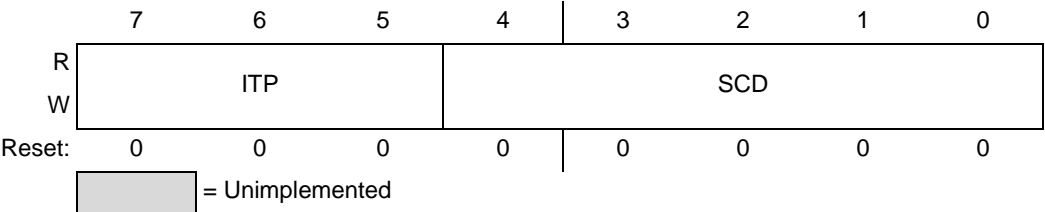

**Stuck Key Timeout Register: 0x09**

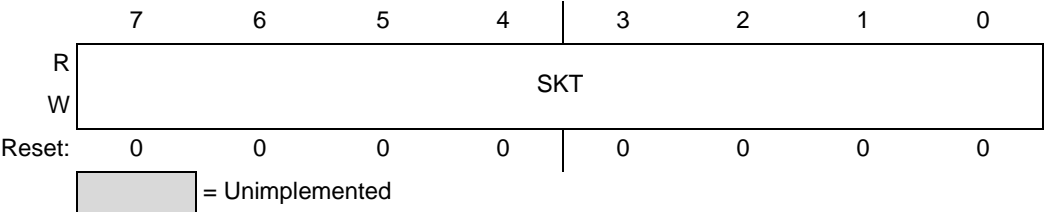

**Configuration Register: 0x0A**

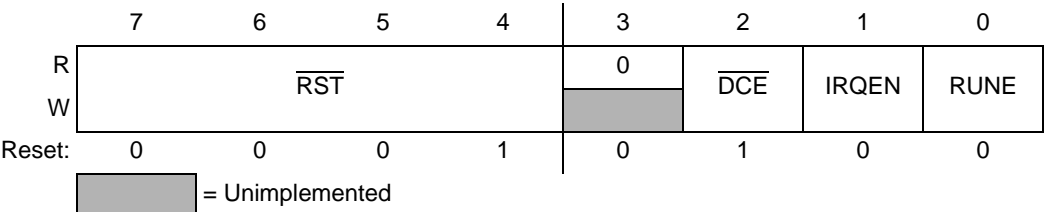

**Sensor Information Register: 0x0B**

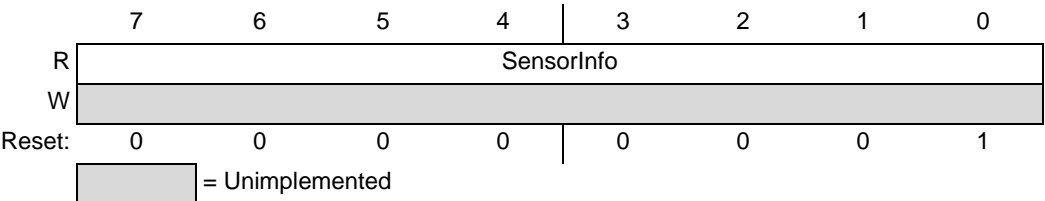

## Appendix C Ordering Information

### C.1 Ordering Information

This section contains ordering information for MPR083Q and MPR083EJ devices.

ORDERING INFORMATION			
Device Name	Temperature Range	Case Number	Rotary Slider
MPR083Q	-40°C to +85°C	1679 (16-Lead QFN)	8-Positions
MPR083EJ		948F (16-Lead TSSOP)	

### C.2 Device Numbering Scheme

All Proximity Sensor Products have a similar numbering scheme. The below diagram explains what each part number in the family represents.

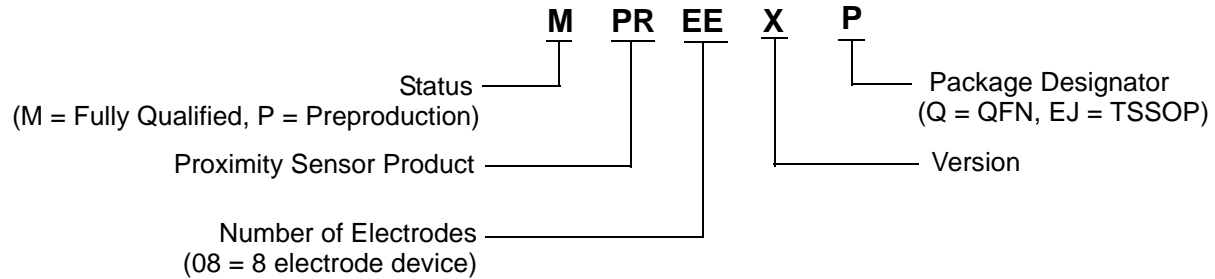





## PACKAGE DIMENSIONS

NOTES:

1. ALL DIMENSIONS ARE IN MILLIMETERS.
2. DIMENSIONING AND TOLERANCING PER ASME Y14.5M-1994.
3. THE COMPLETE JEDEC DESIGNATOR FOR THIS PACKAGE IS: HF-PQFN.
4.  COPLANARITY APPLIES TO LEADS, CORNER LEADS, AND DIE ATTACH PAD.
5. MIN METAL GAP SHOULD BE 0.2MM.

Archived Archived Archived Archived Archived Archived Archived Archived Archived Archived Archived Archived

© FREESCALE SEMICONDUCTOR, INC. ALL RIGHTS RESERVED.		<b>MECHANICAL OUTLINE</b>		PRINT VERSION NOT TO SCALE	
TITLE: THERMALLY ENHANCED QUAD FLAT NON-LEADED PACKAGE (QFN) 16 TERMINAL, 0.8 PITCH (5 X 5 X 1) CASE OUTLINE		DOCUMENT NO: 98ARE10614D		REV: 0	
		CASE NUMBER: 1679-01		23 MAR 2005	
		STANDARD: FREESCALE			

PAGE 3 OF 3





PACKAGE DIMENSIONS

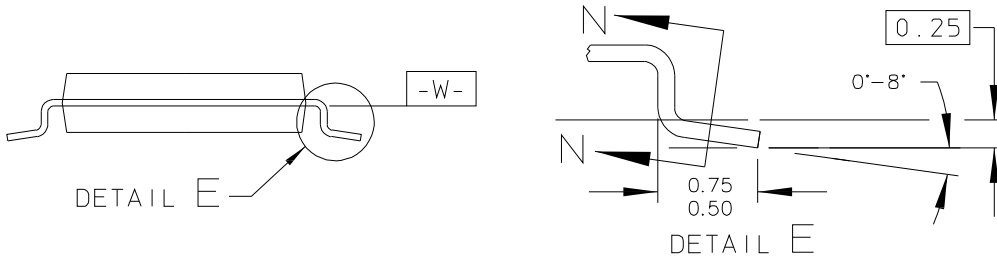
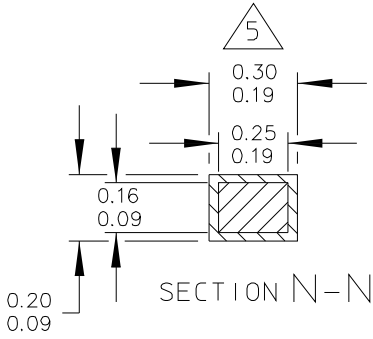

© FREESCALE SEMICONDUCTOR, INC. ALL RIGHTS RESERVED.	MECHANICAL OUTLINE	PRINT VERSION NOT TO SCALE
TITLE:  16 LD TSSOP, PITCH 0.65MM	DOCUMENT NO: 98ASH70247A	REV: B
	CASE NUMBER: 948F-01	19 MAY 2005
	STANDARD: JEDEC	



