

## LMH2121 3 GHz Fast-Responding Linear Power Detector with 40 dB Dynamic Range

Check for Samples: [LMH2121](#)

### FEATURES

- **Linear Response**
- **40 dB Power Detection Range**
- **Very Low Supply Current of 3.4 mA**
- **Short Response Time of 165 ns**
- **Stable Conversion Gain of 3.6 V/V<sub>RMS</sub>**
- **Multi-Band Operation from 100 MHz to 3 GHz**
- **Very Low Conformance Error**
- **High Temperature Stability of ±0.5 dB**
- **Shutdown Functionality**
- **Supply Range from 2.6V to 3.3V**
- **Package:**
  - 4-Bump DSBGA, 0.4mm Pitch

### APPLICATIONS

- **Multi Mode, Multi band RF power control**
  - GSM/EDGE
  - CDMA
  - W-CDMA
  - LTE
  - WAP
- **Tablets**

### DESCRIPTION

The LMH2121 is an accurate fast-responding power detector / RF envelope detector. Its response between an RF input signal and DC output signal is linear. The typical response time of 165 ns makes the device suitable for an accurate power setting in handsets during a rise time of RF transmission slots. It can be used in all popular communications standards: 2G/3G/4G/WAP.

The LMH2121 has an input range from –28 dBm to +12 dBm. Over this input range the device has an intrinsic high insensitivity for temperature, supply voltage and loading. The bandwidth of the device is from 100 MHz to 3 GHz, covering 2G/3G/4G/WiFi wireless bands.

As a result of the unique internal architecture, the device shows an extremely low part-to-part variation of the detection curve. This is demonstrated by its low intercept and slope variation as well as a very good linear conformance. Consequently the required characterization and calibration efforts are low.

The device is active for EN = High; otherwise it is in a low power consumption shutdown mode. To save power and allow for two detector outputs in parallel, the output (OUT) is high impedance during shutdown.

The LMH2121 is offered in a tiny 4-bump DSBGA package: 0.866 mm x 1.07 mm x 0.6 mm.

### TYPICAL APPLICATION

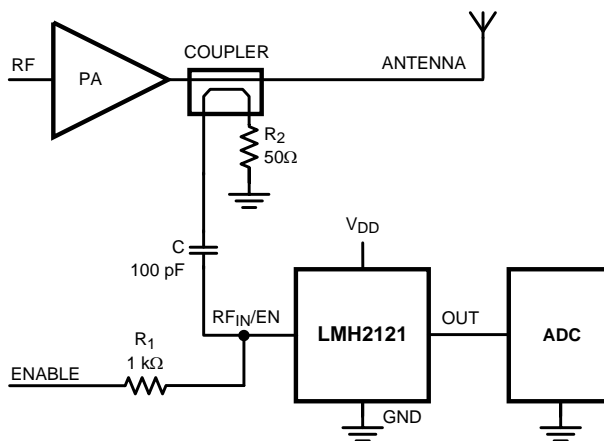

Please be aware that an important notice concerning availability, standard warranty, and use in critical applications of Texas Instruments semiconductor products and disclaimers thereto appears at the end of this data sheet.

All trademarks are the property of their respective owners.



These devices have limited built-in ESD protection. The leads should be shorted together or the device placed in conductive foam during storage or handling to prevent electrostatic damage to the MOS gates.

## ABSOLUTE MAXIMUM RATINGS <sup>(1)(2)</sup>

Supply Voltage		
$V_{DD} - GND$		3.6V
RF <sub>IN</sub> /EN		
$V_{RF\_PEAK} + V_{DC}$		3.6V
ESD Tolerance <sup>(3)</sup>		
Human Body Model		1500V
Machine Model		200V
Charge Device Model		1250V
Storage Temperature Range		-65°C to 150°C
Junction Temperature <sup>(4)</sup>		150°C
For soldering specifications:		
See <a href="http://www.ti.com/general/docs/lit/getliterature.tsp?baseLiteratureNumber=snoa549c">http://www.ti.com/general/docs/lit/getliterature.tsp?baseLiteratureNumber=snoa549c</a>		

- (1) Absolute Maximum Ratings indicate limits beyond which damage to the device may occur. Operating Ratings indicate conditions for which the device is intended to be functional, but specific performance is not ensured. For ensured specifications and the test conditions, see the Electrical Characteristics.
- (2) If Military/Aerospace specified devices are required, please contact the Texas Instruments Sales Office/ Distributors for availability and specifications.
- (3) Human body model, applicable std. MIL-STD-883, Method 3015.7. Machine model, applicable std. JESD22-A115-A (ESD MM std of JEDEC). Field-Induced Charge-Device Model, applicable std. JESD22-C101-C. (ESD FICDM std. of JEDEC)
- (4) The maximum power dissipation is a function of  $T_{J(MAX)}$ ,  $\theta_{JA}$ . The maximum allowable power dissipation at any ambient temperature is  $P_D = (T_{J(MAX)} - T_A)/\theta_{JA}$ . All numbers apply for packages soldered directly into a PC board.

## OPERATING RATINGS <sup>(1)</sup>

Supply Voltage	2.6V to 3.3V
Temperature Range	-40°C to +85°C
RF Frequency Range	100 MHz to 3 GHz
RF Input Power Range	-28 dBm to +12 dBm
Package Thermal Resistance $\theta_{JA}$ <sup>(2)</sup>	130.9°C/W

- (1) Absolute Maximum Ratings indicate limits beyond which damage to the device may occur. Operating Ratings indicate conditions for which the device is intended to be functional, but specific performance is not ensured. For ensured specifications and the test conditions, see the Electrical Characteristics.
- (2) The maximum power dissipation is a function of  $T_{J(MAX)}$ ,  $\theta_{JA}$ . The maximum allowable power dissipation at any ambient temperature is  $P_D = (T_{J(MAX)} - T_A)/\theta_{JA}$ . All numbers apply for packages soldered directly into a PC board.

## 2.7 V DC AND AC ELECTRICAL CHARACTERISTICS

Unless otherwise specified, all limits are ensured to  $T_A = 25^\circ\text{C}$ ,  $V_{DD} = 2.7\text{V}$ , RF<sub>IN</sub> = 1900 MHz CW (Continuous Wave, unmodulated), EN = 2.7V. **Boldface** limits apply at the temperature extremes <sup>(1)</sup>.

Symbol	Parameter	Condition	Min <sup>(2)</sup>	Typ <sup>(3)</sup>	Max <sup>(2)</sup>	Units
<b>Supply Interface</b>						
$I_{DD}$	Supply Current	Active Mode. EN= High, no RF input Signal	<b>2.4</b>	3.4	<b>4.7</b>	mA
		Shutdown. EN= Low, no RF input Signal			<b>2</b>	μA

- (1) Electrical Table values apply only for factory testing conditions at the temperature indicated. Factory testing conditions result in very limited self-heating of the device such that  $T_J = T_A$ . No specification of parametric performance is indicated in the electrical tables under conditions of internal self-heating where  $T_J > T_A$ .
- (2) All limits are ensured by test or statistical analysis.
- (3) Typical values represent the most likely parametric norm as determined at the time of characterization. Actual typical values may vary over time and will also depend on the application and configuration. The typical values are not tested and are not specified on shipped production material.

## 2.7 V DC AND AC ELECTRICAL CHARACTERISTICS (continued)

Unless otherwise specified, all limits are ensured to  $T_A = 25^\circ\text{C}$ ,  $V_{DD} = 2.7\text{V}$ ,  $R_{F_{IN}} = 1900\text{ MHz CW}$  (Continuous Wave, unmodulated),  $E_N = 2.7\text{V}$ . **Boldface** limits apply at the temperature extremes <sup>(1)</sup>.

Symbol	Parameter	Condition	Min (2)	Typ (3)	Max (2)	Units
PSRR	Power Supply Rejection Ratio	$R_{F_{IN}} = -10\text{ dBm}$ , 1900 MHz, $2.6\text{V} < V_{DD} < 3.3\text{V}$	40	69		dB
<b>Logic Enable Interface</b>						
$V_{LOW}$	$R_{F_{IN}}/E_N$ logic LOW input level (Shutdown)				<b>0.6</b>	V
$V_{HIGH}$	$R_{F_{IN}}/E_N$ logic HIGH input level (Active)		<b>1.1</b>			
$I_{R_{F_{IN}}/E_N}$	Current into $R_{F_{IN}}/E_N$ pin	$E_N = 1.8\text{V}$			<b>1</b>	$\mu\text{A}$
<b>Input / Output Interface</b>						
$Z_{IN}$	Input Impedance	Resistor and Capacitor in series from $R_{F_{IN}}/E_N$ to GND	$R_{IN}$		50	$\Omega$
			$C_{IN}$		30	pF
$V_{OUT}$	Minimum Output Voltage (Pedestal)	No RF Input Signal		18	<b>30</b> <b>38</b>	mV
$R_{OUT}$	Output Resistance	$R_{F_{IN}} = -10\text{ dBm}$ , 1900 MHz, $I_{LOAD} = 1\text{ mA}$ , DC measurement		100	<b>117</b> <b>120</b>	$\Omega$
$I_{OUT}$	Output Sinking Current	$R_{F_{IN}} = -10\text{ dBm}$ , 1900 MHz, OUT connected to 2.5V	<b>17</b> <b>16</b>	20		mA
	Output Sourcing Current	$R_{F_{IN}} = -10\text{ dBm}$ , 1900 MHz, OUT connected to GND	1.30 <b>1.28</b>	1.86		
$I_{OUT, SD}$	Output Leakage Current in Shutdown	$V_{EN} = \text{Low}$ , OUT is connected to 2V			<b>80</b>	nA
$e_n$	Output Referred Noise <sup>(4)</sup>	$R_{F_{IN}} = -23\text{ dBm}$ , 1900 MHz, output spectrum at 10 kHz		18		$\mu\text{V}/\sqrt{\text{Hz}}$
$v_n$	Output Referred Noise Integrated <sup>(4)</sup>	$R_{F_{IN}} = -23\text{ dBm}$ , 1900 MHz, Integrated over frequency band 1 kHz -13 kHz		2		$\text{mV}_{RMS}$
<b>Timing Characteristics</b>						
$t_{ON}$	Turn-on Time from Shutdown <sup>(4)</sup>	$R_{F_{IN}} = -10\text{ dBm}$ , 1900 MHz, $V_{EN}$ LOW-to-HIGH transition to OUT at 90%		1.3		$\mu\text{s}$
$t_R$	Rise Time <sup>(4)</sup>	Signal at $R_{F_{IN}}$ from $-20\text{ dBm}$ to 5 dBm, 10% to 90%, 1900 MHz		165		ns
$t_F$	Fall Time <sup>(4)</sup>	Signal at $R_{F_{IN}}$ from 5 dBm to $-20\text{ dBm}$ , 90% to 10%, 1900 MHz		285		ns
<b>RF Detector Transfer</b> , fit range $-15\text{ dBm}$ to $-5\text{ dBm}$ for Linear Slope and Intercept <b><math>R_{F_{IN}} = 100\text{ MHz}</math></b> <sup>(5)</sup>						
$P_{MIN}$	Minimum Power Level, bottom end of Dynamic Range	Lin Conformance Error within $\pm 1\text{ dB}$		-33		dBm
$P_{MAX}$	Maximum Power Level, top end of Dynamic Range			12		
$V_{MIN}$	Minimum Output Voltage	At $P_{MIN}$		20		mV
$V_{MAX}$	Maximum Output Voltage	At $P_{MAX}$		2.7		V
$K_{SLOPE}$	Linear Slope			1		dB/dB
$P_{INT}$	Linear Intercept	$V_{OUT} = 0\text{ dBV}$	1.2	1.9	2.4	dBm
Gain	Conversion Gain		3.4	3.6	3.9	$\text{V}/\text{V}_{RMS}$
DR	Dynamic Range for specified Accuracy	$\pm 1\text{ dB}$ Lin Conformance Error ( $E_{LC}$ )	<b>34</b> <b>25</b>	<b>45</b> <b>32</b>		dB
		$\pm 3\text{ dB}$ Lin Conformance Error ( $E_{LC}$ )	<b>47</b> <b>41</b>	<b>49</b> <b>46</b>		
		$\pm 1\text{ dB}$ Input Referred Variation over Temperature ( $E_{VOT}$ )	<b>26</b>	<b>31</b>		

(4) This parameter is ensured by design and/or characterization and is not tested in production.

(5) Limits are ensured by design and measurements which are performed on a limited number of samples.

## 2.7 V DC AND AC ELECTRICAL CHARACTERISTICS (continued)

Unless otherwise specified, all limits are ensured to  $T_A = 25^\circ\text{C}$ ,  $V_{DD} = 2.7\text{V}$ ,  $R_{F_{IN}} = 1900\text{ MHz CW}$  (Continuous Wave, unmodulated),  $EN = 2.7\text{V}$ . **Boldface** limits apply at the temperature extremes <sup>(1)</sup>.

Symbol	Parameter	Condition	Min (2)	Typ (3)	Max (2)	Units
<b><math>R_{F_{IN}} = 700\text{ MHz}^{(5)}</math></b>						
$P_{MIN}$	Minimum Power Level, bottom end of Dynamic Range	Lin Conformance Error within $\pm 1\text{ dB}$		-33		dBm
$P_{MAX}$	Maximum Power Level, top end of Dynamic Range			12		
$V_{MIN}$	Minimum Output Voltage	At $P_{MIN}$		20		mV
$V_{MAX}$	Maximum Output Voltage	At $P_{MAX}$		2.65		V
$K_{SLOPE}$	Linear Slope			1		dB/dB
$P_{INT}$	Linear Intercept	$V_{OUT} = 0\text{ dBV}$	1.3	1.9	2.2	dBm
Gain	Conversion Gain		3.5	3.6	3.9	V/V <sub>RMS</sub>
DR	Dynamic Range for specified Accuracy	$\pm 1\text{ dB}$ Lin Conformance Error ( $E_{LC}$ )	34 <b>34</b>	45 <b>38</b>		dB
		$\pm 3\text{ dB}$ Lin Conformance Error ( $E_{LC}$ )	47 <b>39</b>	50 <b>47</b>		
		$\pm 0.5\text{ dB}$ Input Referred Variation over Temperature ( $E_{VOT}$ )	<b>34</b>	<b>37</b>		
<b><math>R_{F_{IN}} = 900\text{ MHz}^{(5)}</math></b>						
$P_{MIN}$	Minimum Power Level, bottom end of Dynamic Range	Lin Conformance Error within $\pm 1\text{ dB}$		-33		dBm
$P_{MAX}$	Maximum Power Level, top end of Dynamic Range			12		
$V_{MIN}$	Minimum Output Voltage	At $P_{MIN}$		20		mV
$V_{MAX}$	Maximum Output Voltage	At $P_{MAX}$		2.68		V
$K_{SLOPE}$	Linear Slope			1		dB/dB
$P_{INT}$	Linear Intercept	$V_{OUT} = 0\text{ dBV}$	1.7	2.1	2.5	dBm
Gain	Conversion Gain		3.4	3.5	3.7	V/V <sub>RMS</sub>
DR	Dynamic Range for specified Accuracy	$\pm 1\text{ dB}$ Lin Conformance Error ( $E_{LC}$ )	34 <b>33</b>	45 <b>37</b>		dB
		$\pm 3\text{ dB}$ Lin Conformance Error ( $E_{LC}$ )	48 <b>40</b>	50 <b>47</b>		
		$\pm 0.5\text{ dB}$ Input Referred Variation over Temperature ( $E_{VOT}$ )	<b>35</b>	<b>37</b>		
<b><math>R_{F_{IN}} = 1700\text{ MHz}^{(6)}</math></b>						
$P_{MIN}$	Minimum Power Level, bottom end of Dynamic Range	Lin Conformance Error within $\pm 1\text{ dB}$		-24		dBm
$P_{MAX}$	Maximum Power Level, top end of Dynamic Range			7		
$V_{MIN}$	Minimum Output Voltage	At $P_{MIN}$		37		mV
$V_{MAX}$	Maximum Output Voltage	At $P_{MAX}$		1.23		V
$K_{SLOPE}$	Linear Slope			1		dB/dB
$P_{INT}$	Linear Intercept	$V_{OUT} = 0\text{ dBV}$	3.8	4.1	4.5	dBm
Gain	Conversion Gain		2.6	2.8	2.9	V/V <sub>RMS</sub>
DR	Dynamic Range for specified Accuracy	$\pm 1\text{ dB}$ Lin Conformance Error ( $E_{LC}$ )	27 <b>24</b>	31 <b>28</b>		dB
		$\pm 3\text{ dB}$ Lin Conformance Error ( $E_{LC}$ )	44 <b>34</b>	47 <b>43</b>		
		$\pm 0.5\text{ dB}$ Input Referred Variation over Temperature ( $E_{VOT}$ )	<b>26</b>	<b>31</b>		

(6) Limits are ensured by design and measurements which are performed on a limited number of samples.

## 2.7 V DC AND AC ELECTRICAL CHARACTERISTICS (continued)

Unless otherwise specified, all limits are ensured to  $T_A = 25^\circ\text{C}$ ,  $V_{DD} = 2.7\text{V}$ ,  $R_{F_{IN}} = 1900\text{ MHz CW}$  (Continuous Wave, unmodulated),  $EN = 2.7\text{V}$ . **Boldface** limits apply at the temperature extremes <sup>(1)</sup>.

Symbol	Parameter	Condition	Min (2)	Typ (3)	Max (2)	Units
<b><math>R_{F_{IN}} = 1900\text{ MHz}</math></b> <sup>(7)</sup>						
$P_{MIN}$	Minimum Power Level, bottom end of Dynamic Range	Lin Conformance Error within $\pm 1\text{ dB}$		-24		dBm
$P_{MAX}$	Maximum Power Level, top end of Dynamic Range			7		
$V_{MIN}$	Minimum Output Voltage	At $P_{MIN}$		33		mV
$V_{MAX}$	Maximum Output Voltage	At $P_{MAX}$		1.1		V
$K_{SLOPE}$	Linear Slope			1		dB/dB
$P_{INT}$	Linear Intercept	$V_{OUT} = 0\text{ dBV}$	4.7	5	5.3	dBm
Gain	Conversion Gain		2.4	2.5	2.6	V/V <sub>RMS</sub>
DR	Dynamic Range for specified Accuracy	$\pm 1\text{ dB}$ Lin Conformance Error ( $E_{LC}$ )	26 <b>23</b>	31 <b>27</b>		dB
		$\pm 3\text{ dB}$ Lin Conformance Error ( $E_{LC}$ )	43 <b>33</b>	45 <b>41</b>		
		$\pm 0.5\text{ dB}$ Input Referred Variation over Temperature ( $E_{VOT}$ )	<b>26</b>	<b>29</b>		
<b><math>R_{F_{IN}} = 2600\text{ MHz}</math></b> <sup>(7)</sup>						
$P_{MIN}$	Minimum Power Level, bottom end of Dynamic Range	Lin Conformance Error within $\pm 1\text{ dB}$		-22		dBm
$P_{MAX}$	Maximum Power Level, top end of Dynamic Range			6		
$V_{MIN}$	Minimum Output Voltage	At $P_{MIN}$		35		mV
$V_{MAX}$	Maximum Output Voltage	At $P_{MAX}$		0.78		V
$K_{SLOPE}$	Linear Slope			1		dB/dB
$P_{INT}$	Linear Intercept	$V_{OUT} = 0\text{ dBV}$	6.3	6.7	7.1	dBm
Gain	Conversion Gain		2.0	2.1	2.2	V/V <sub>RMS</sub>
DR	Dynamic Range for specified Accuracy	$\pm 1\text{ dB}$ Lin Conformance Error ( $E_{LC}$ )	24 <b>21</b>	28 <b>25</b>		dB
		$\pm 3\text{ dB}$ Lin Conformance Error ( $E_{LC}$ )	40 <b>30</b>	42 <b>38</b>		
		$\pm 0.5\text{ dB}$ Input Referred Variation over Temperature ( $E_{VOT}$ )	<b>21</b>	<b>27</b>		

(7) Limits are ensured by design and measurements which are performed on a limited number of samples.

### CONNECTION DIAGRAM

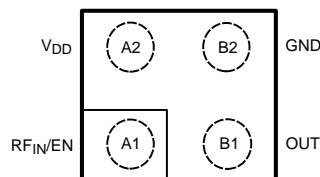

Figure 1. 4-bump DSBGA (Top View)

**PIN DESCRIPTIONS**

Name	DSBGA	Description
V <sub>DD</sub>	A2	Positive Supply Voltage.
GND	B2	Ground
RF <sub>IN</sub> /EN	A1	DC voltage determines the state of the device (HIGH = device is active, LOW = device in shutdown). AC voltage is the RF input signal to the detector (beyond 100 MHz). The RF <sub>IN</sub> /EN pin is internally terminated with 50Ω in series with 30 pF.
OUT	B1	Ground referenced detector output voltage.

**BLOCK DIAGRAM**

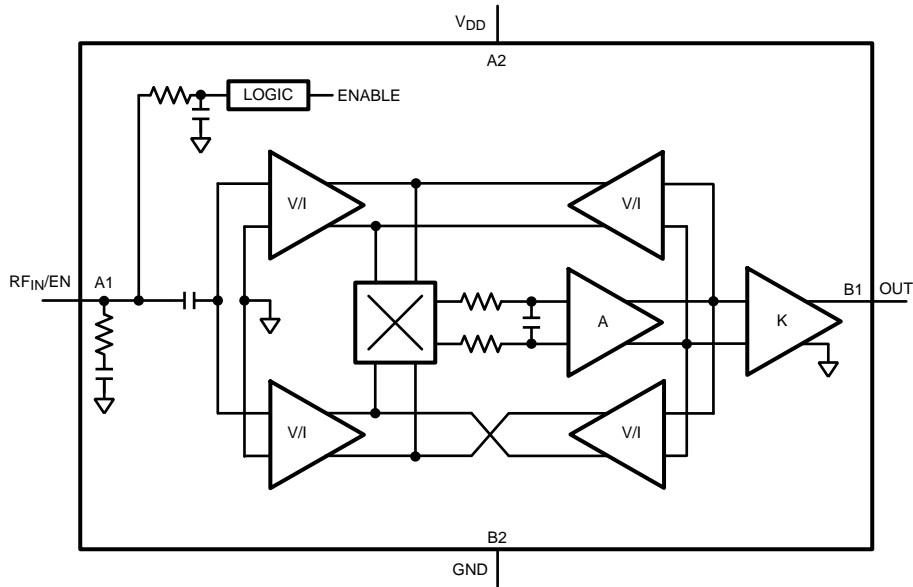

Figure 2. LMH2121

### TYPICAL PERFORMANCE CHARACTERISTICS

Unless otherwise specified  $T_A = 25^\circ\text{C}$ ,  $V_{DD} = 2.7\text{V}$ ,  $R_{FIN} = 1900\text{ MHz CW}$  (Continuous Wave, unmodulated). Specified errors are input referred.

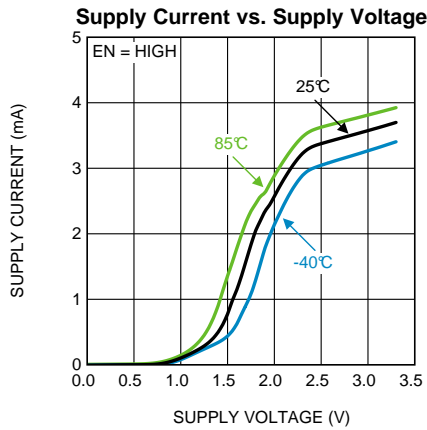

Figure 3.

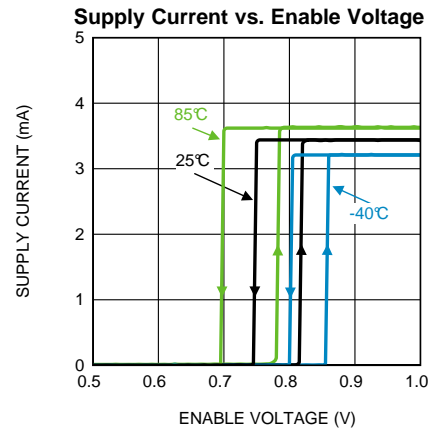

Figure 4.

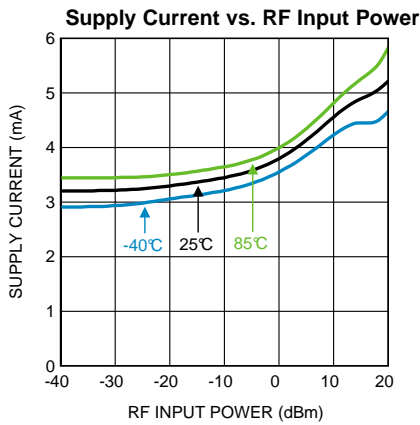

Figure 5.

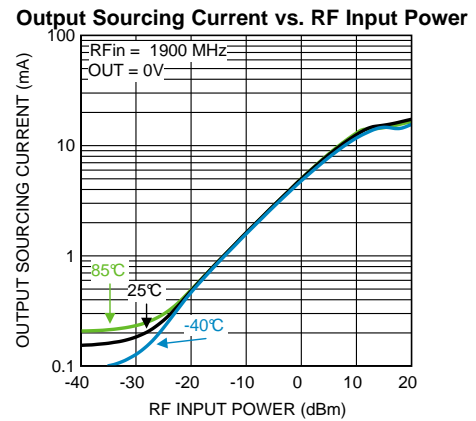

Figure 6.

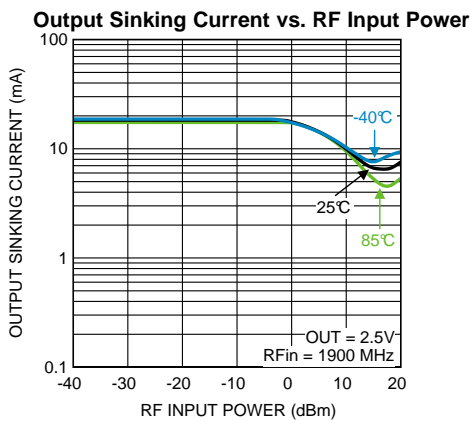

Figure 7.

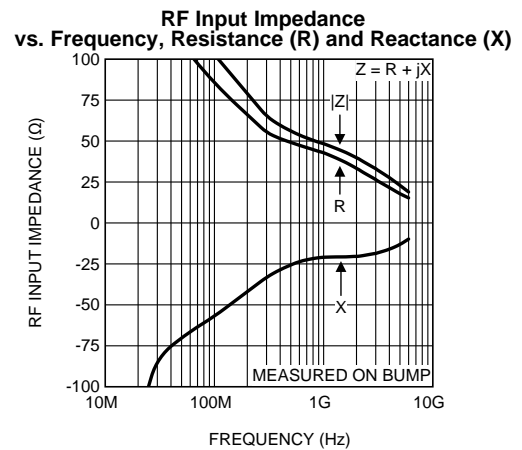

Figure 8.

### TYPICAL PERFORMANCE CHARACTERISTICS (continued)

Unless otherwise specified  $T_A = 25^\circ\text{C}$ ,  $V_{DD} = 2.7\text{V}$ ,  $R_{F_{IN}} = 1900\text{ MHz CW}$  (Continuous Wave, unmodulated). Specified errors are input referred.

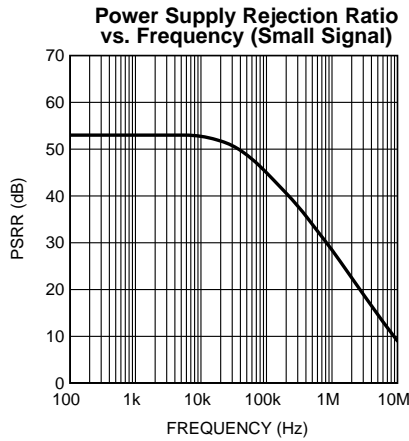

Figure 9.

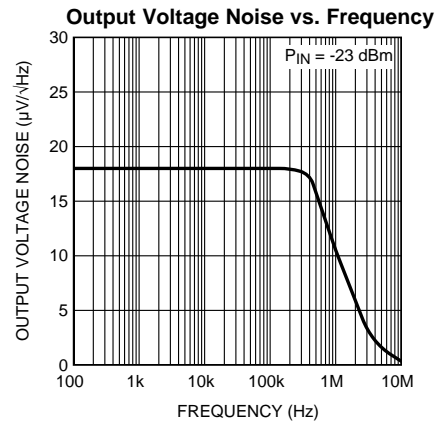

Figure 10.

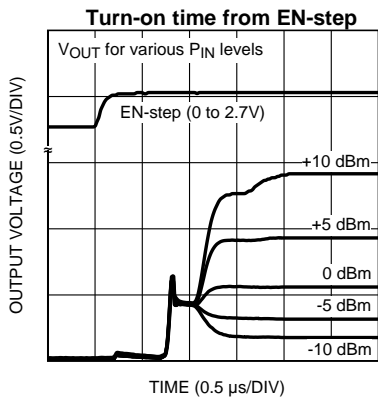

Figure 11.

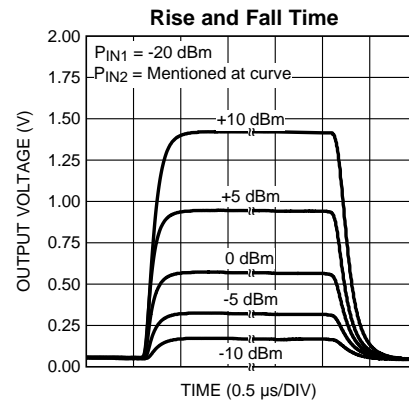

Figure 12.

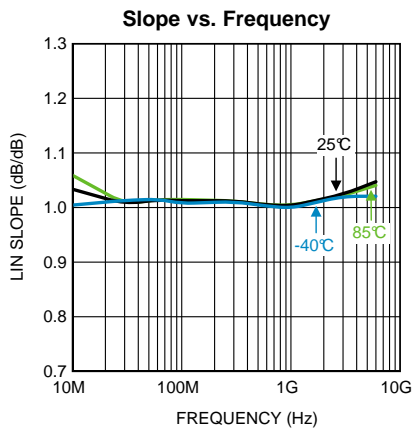

Figure 13.

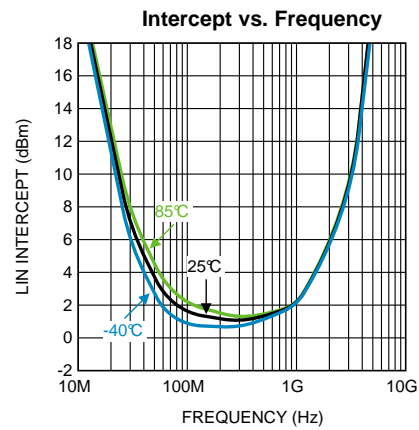

Figure 14.



**TYPICAL PERFORMANCE CHARACTERISTICS (continued)**

Unless otherwise specified  $T_A = 25^\circ\text{C}$ ,  $V_{DD} = 2.7\text{V}$ ,  $R_{F_{IN}} = 1900\text{ MHz CW}$  (Continuous Wave, unmodulated). Specified errors are input referred.

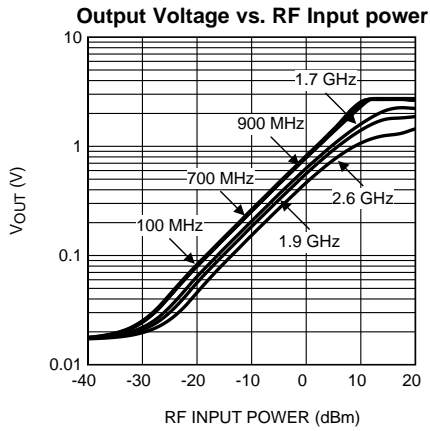

Figure 15.

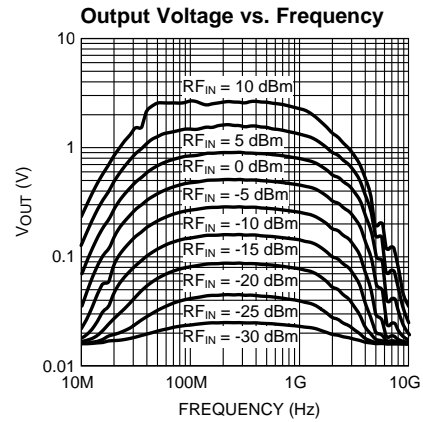

Figure 16.

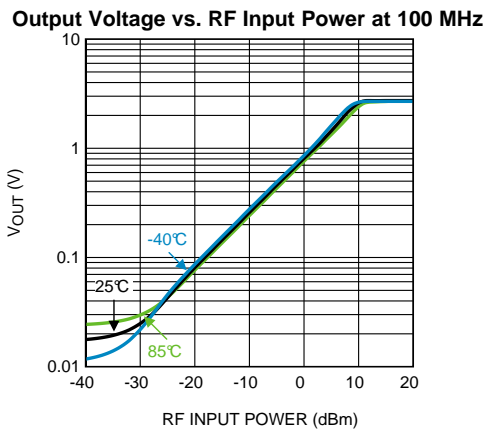

Figure 17.

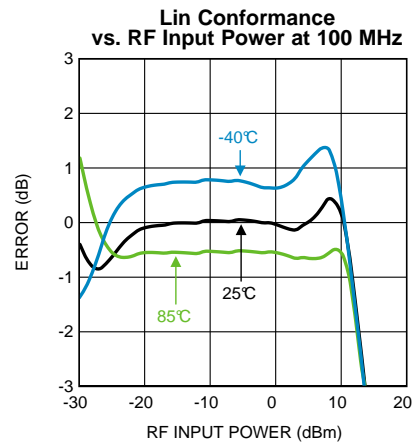

Figure 18.

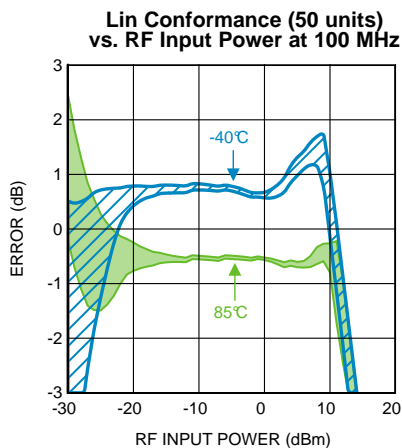

Figure 19.

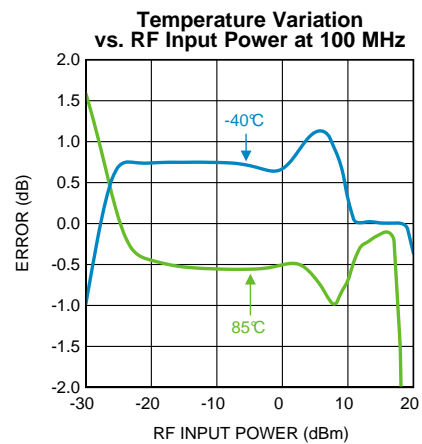

Figure 20.

**TYPICAL PERFORMANCE CHARACTERISTICS (continued)**

Unless otherwise specified  $T_A = 25^\circ\text{C}$ ,  $V_{DD} = 2.7\text{V}$ ,  $R_{F\text{IN}} = 1900\text{ MHz CW}$  (Continuous Wave, unmodulated). Specified errors are input referred.

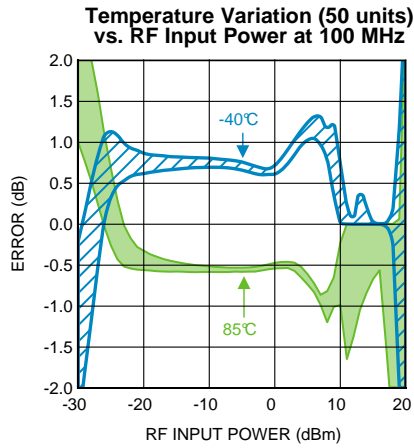

Figure 21.

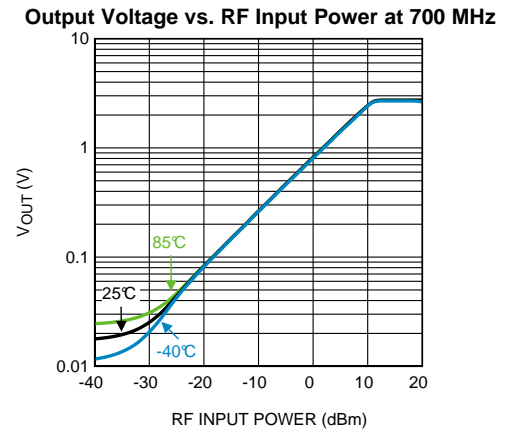

Figure 22.

**Lin Conformance vs. RF Input Power at 700 MHz**

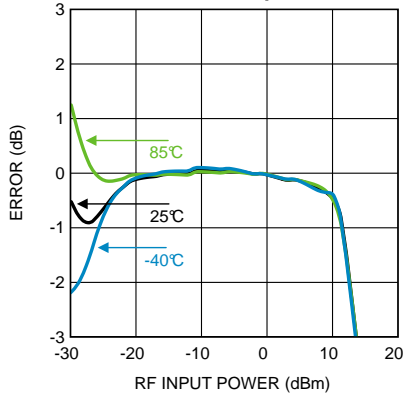

Figure 23.

**Lin Conformance (50 units) vs. RF Input Power at 700 MHz**

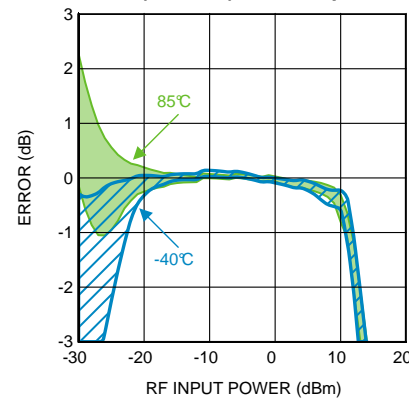

Figure 24.

**Temperature Variation vs. RF Input Power at 700 MHz**

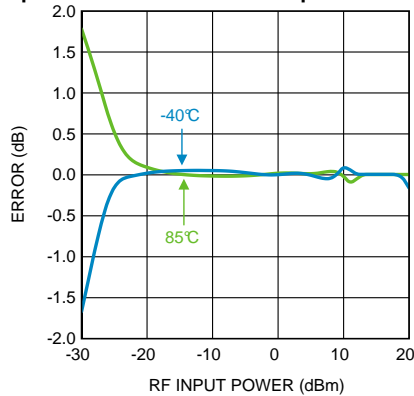

Figure 25.

**Temperature Variation (50 units) vs. RF Input Power at 700 MHz**

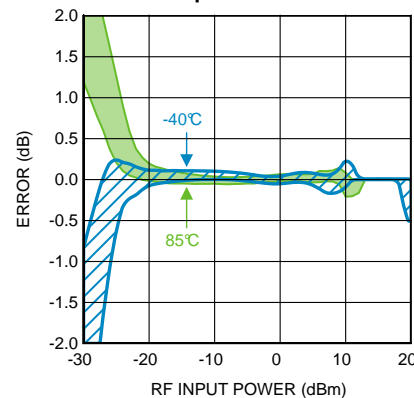

Figure 26.

**TYPICAL PERFORMANCE CHARACTERISTICS (continued)**

Unless otherwise specified  $T_A = 25^\circ\text{C}$ ,  $V_{DD} = 2.7\text{V}$ ,  $R_{F\text{IN}} = 1900\text{ MHz CW}$  (Continuous Wave, unmodulated). Specified errors are input referred.

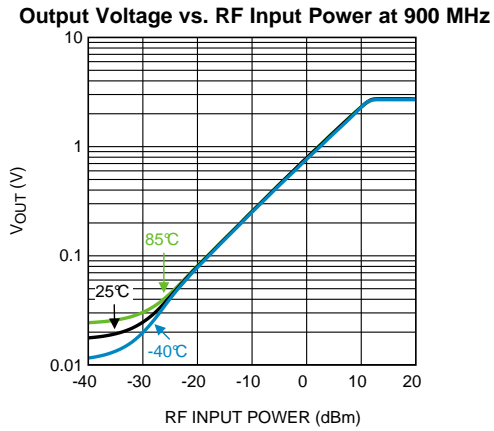

Figure 27.

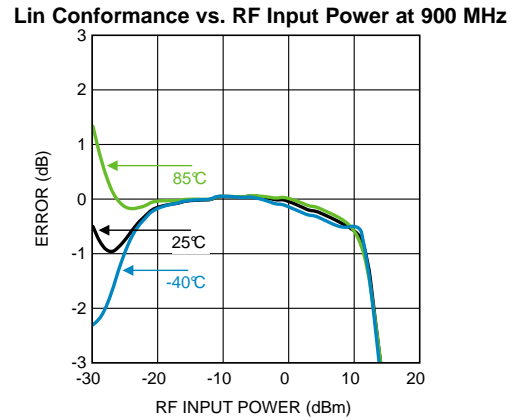

Figure 28.

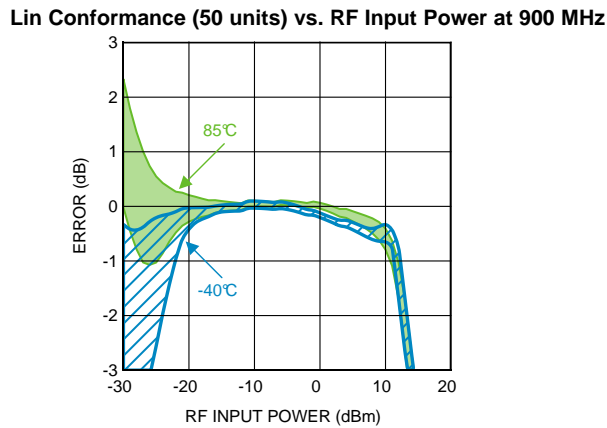

Figure 29.

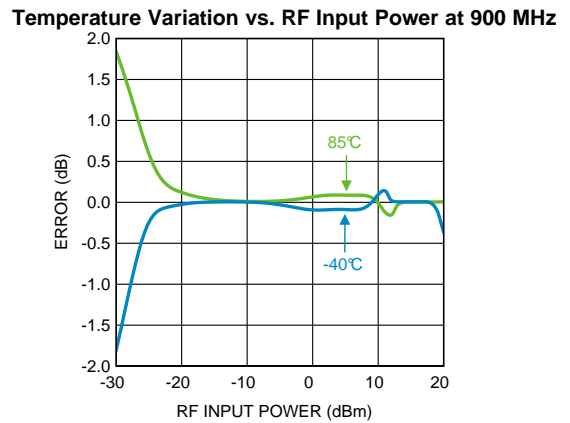

Figure 30.

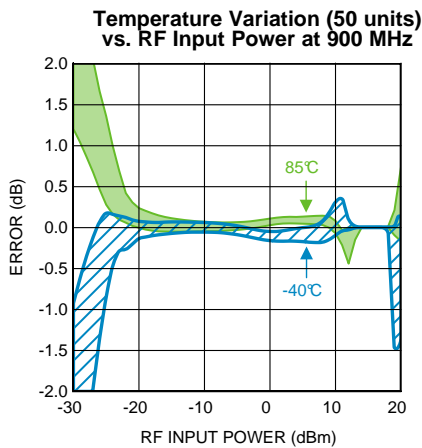

Figure 31.

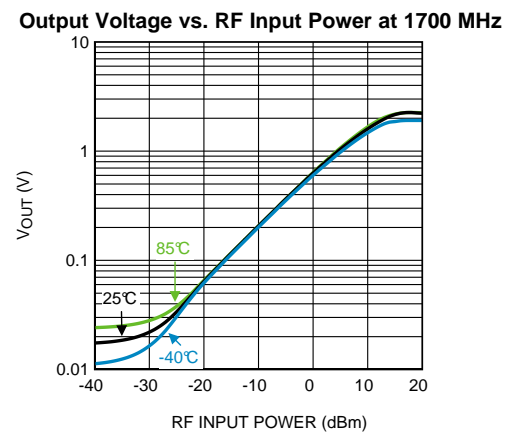
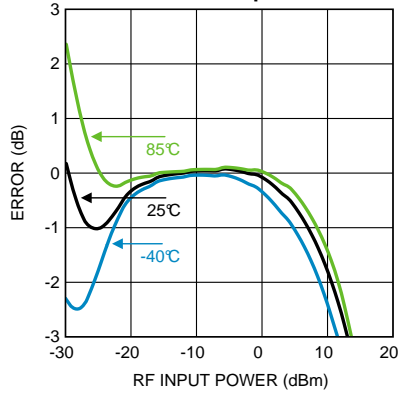

Figure 32.

**TYPICAL PERFORMANCE CHARACTERISTICS (continued)**

Unless otherwise specified  $T_A = 25^\circ\text{C}$ ,  $V_{DD} = 2.7\text{V}$ ,  $\text{RF}_{IN} = 1900\text{ MHz CW}$  (Continuous Wave, unmodulated). Specified errors are input referred.

**Lin Conformance vs. RF Input Power at 1700 MHz**



**Figure 33.**

**Lin Conformance (50 units) vs. RF Input Power at 1700 MHz**

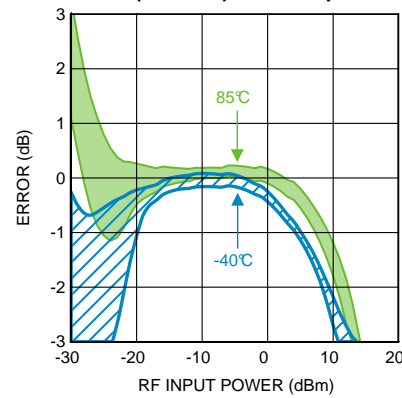

**Figure 34.**

**Temperature Variation vs. RF Input Power at 1700 MHz**

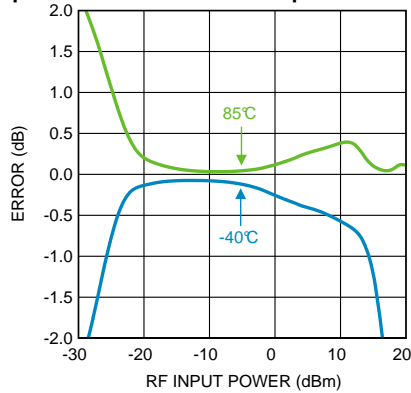

**Figure 35.**

**Temperature Variation (50 units) vs. RF Input Power at 1700 MHz**

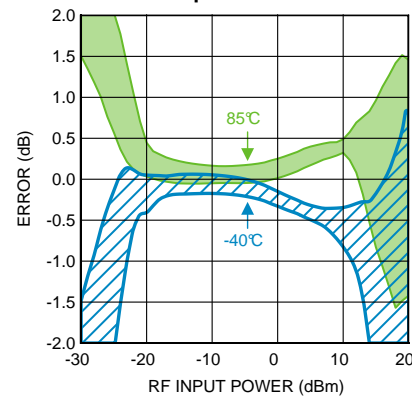

**Figure 36.**

**Output Voltage vs. RF Input Power at 1900 MHz**

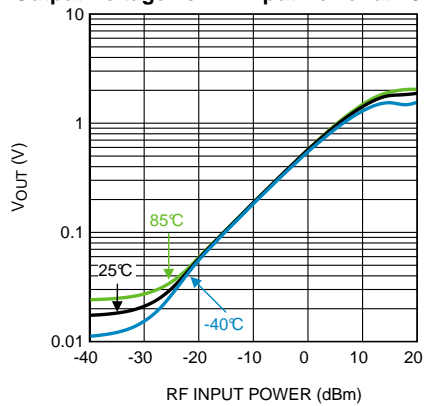

**Figure 37.**

**Lin Conformance vs. RF Input Power at 1900 MHz**

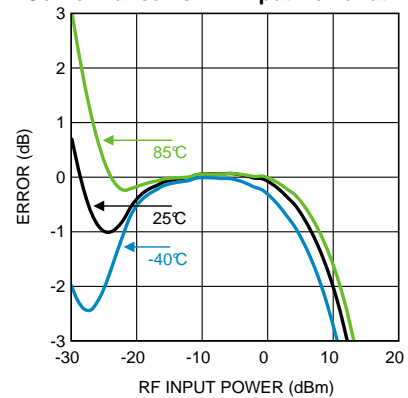
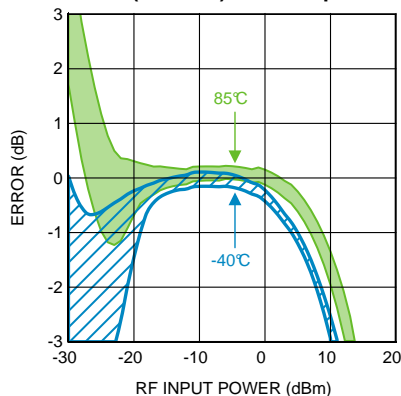

**Figure 38.**

**TYPICAL PERFORMANCE CHARACTERISTICS (continued)**

Unless otherwise specified  $T_A = 25^\circ\text{C}$ ,  $V_{DD} = 2.7\text{V}$ ,  $R_{F\text{IN}} = 1900\text{ MHz CW}$  (Continuous Wave, unmodulated). Specified errors are input referred.

**Lin Conformance (50 units) vs. RF Input Power at 1900 MHz**



**Figure 39.**

**Temperature Variation vs. RF Input Power at 1900 MHz**

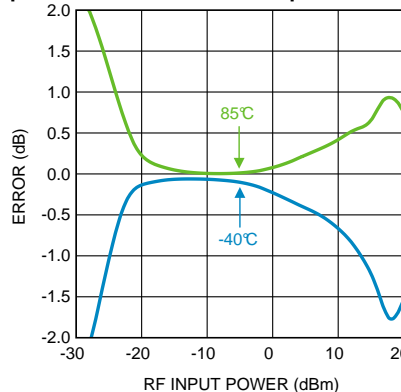

**Figure 40.**

**Temperature Variation (50 units) vs. RF Input Power at 1900 MHz**

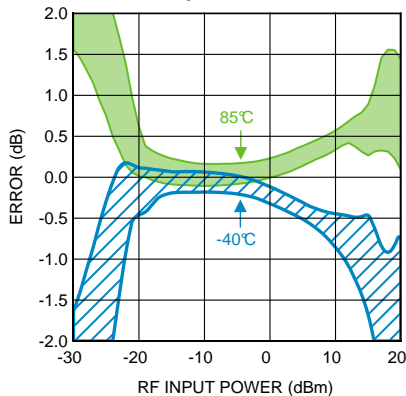

**Figure 41.**

**Output Voltage vs. RF Input Power at 2600 MHz**

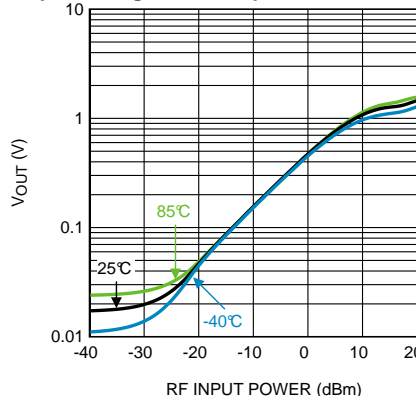

**Figure 42.**

**Lin Conformance vs. RF Input Power at 2600 MHz**

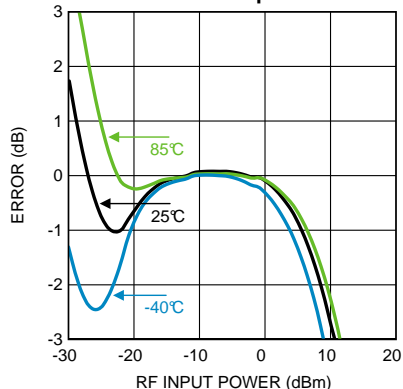

**Figure 43.**

**Lin Conformance (50 units) vs. RF Input Power at 2600 MHz**

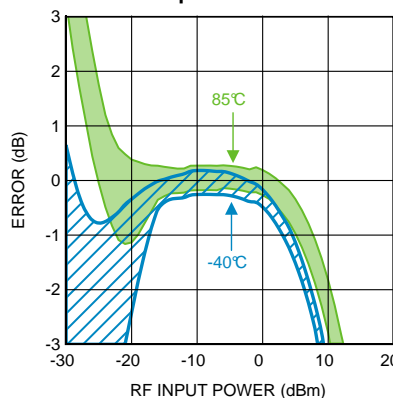
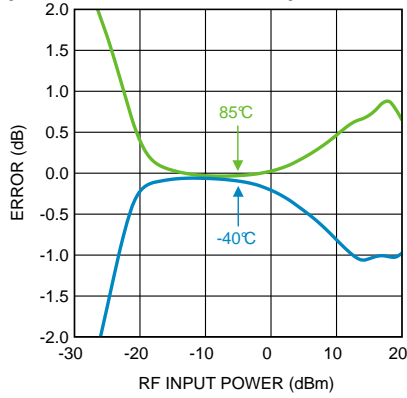

**Figure 44.**

**TYPICAL PERFORMANCE CHARACTERISTICS (continued)**

Unless otherwise specified  $T_A = 25^\circ\text{C}$ ,  $V_{DD} = 2.7\text{V}$ ,  $R_{F_{IN}} = 1900\text{ MHz CW}$  (Continuous Wave, unmodulated). Specified errors are input referred.

**Temperature Variation vs. RF Input Power at 2600 MHz**



**Figure 45.**

**Temperature Variation (50 units) vs. RF Input Power at 2600 MHz**

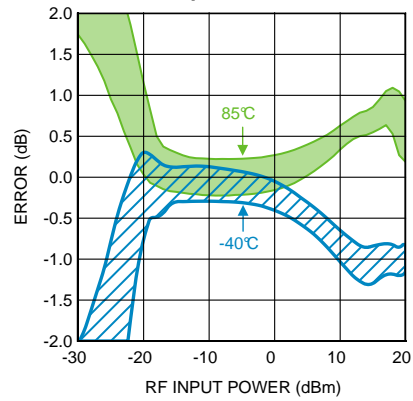

**Figure 46.**

## APPLICATION INFORMATION

The LMH2121 is an accurate fast-responding power detector / RF envelope detector. Its response between an RF input signal and DC output signal is linear. The typical response time of 165 ns makes the device suitable for an accurate power setting in handsets during a rise time of RF transmission slots. It can be used in all popular communications standards: 2G/3G/4G/WAP.

The LMH2121 has an input range from  $-28$  dBm to  $+12$  dBm. Over this input range the device has an intrinsic high insensitivity for temperature, supply voltage and loading. The bandwidth of the device is from 100 MHz to 3 GHz, covering 2G/3G/4G/WiFi wireless bands.

### TYPICAL APPLICATION

The LMH2121 can be used in a wide variety of applications such as LTE, W-CDMA, CDMA and GSM. This section discusses the LMH2121 in a typical transmit power control loop for such applications.

Transmit-power control-loop circuits make the transmit-power level insensitive to power amplifier (PA) inaccuracy. This is desirable because power amplifiers are non-linear devices and temperature dependent, making it hard to estimate the exact transmit power level. If a control loop is used, the inaccuracy of the PA is eliminated from the overall accuracy of the transmit-power level. The accuracy of the transmit power level now depends on the RF detector accuracy instead. The LMH2121 is especially suited for transmit-power control applications, since it accurately measures transmit power and is insensitive to temperature and supply voltage variations.

Figure 47 shows a simplified schematic of a typical transmit-power control system. The output power of the PA is measured by the LMH2121 through a directional coupler. The measured output voltage of the LMH2121 is digitized by the ADC inside the baseband chip. Accordingly, the baseband controls the PA output power level by changing the gain control signal of the RF VGA.

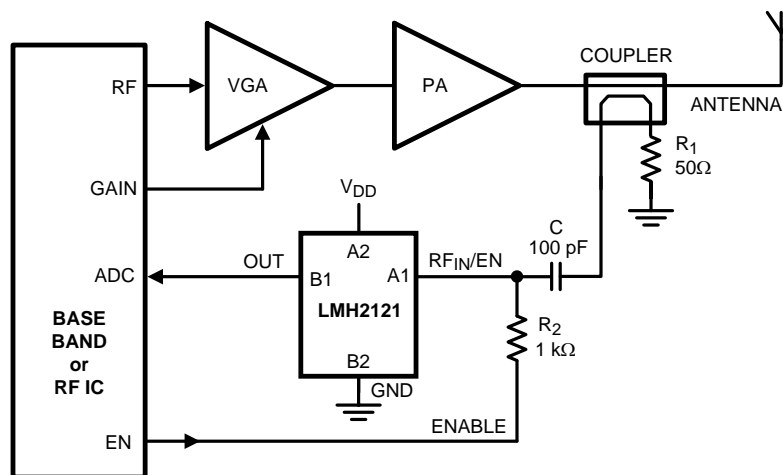

Figure 47. Transmit-Power Control System

### ACCURATE POWER MEASUREMENT

Detectors have evolved over the years along with the communication standards. Newer communication standards like LTE and W-CDMA raise the need for more advanced accurate power detectors. To be able to distinguish the various detector types it is important to understand what the ideal power measurement should look like and how a power measurement is implemented.

Power is often used as a metric for the strength of a signal in communication applications. By definition it is not a function of the signal shape over time. In other words, the power content of a 0 dBm sine wave is identical to the power content of a 0 dBm square wave or a 0 dBm W-CDMA signal; all these signals have the same average power content.

The average power can be described by the following formula:

$$P(T) = \frac{1}{T} \int_0^T \frac{v(t)^2}{R} dt \quad (1)$$

where  $T$  is the time interval over which is averaged,  $v(t)$  is the instantaneous voltage at time  $t$ , and  $R$  is the resistance in which the power is dissipated.

When the resistor is constant (assume a  $50\Omega$  system), the average power is proportional to average of the square of the instantaneous voltage:

$$P \propto \frac{1}{T} \int_0^T v(t)^2 dt \quad (2)$$

For RF applications in which modulated signals are used, for instance, the instantaneous voltage can be described by:

$$v(t) = [1 + a(t)] \sin(\omega_c t) \quad (3)$$

where  $a(t)$  is the amplitude modulation and  $\omega_c$  the carrier frequency. The frequency of  $a(t)$  is typically on the order of a couple of MHz (up to 20 MHz) depending on the modulation standard. This is relatively low with respect to the carrier frequency, i.e., several hundreds of MHz up to a few GHz.

For determining the average power of an RF modulated signal it is important how long the detector integrates (averages) the RF signal relative to the speed of the modulation variation. On one hand, detectors with a relatively high integration time will produce a constant output since the modulation is averaged-out (Figure 48-a). An example of such a detector is an RMS detector. On the other hand, when the integration time is relatively short, the detector output will track the envelope of the RF signal (Figure 48-b). These RF detectors are typically called envelope detectors.

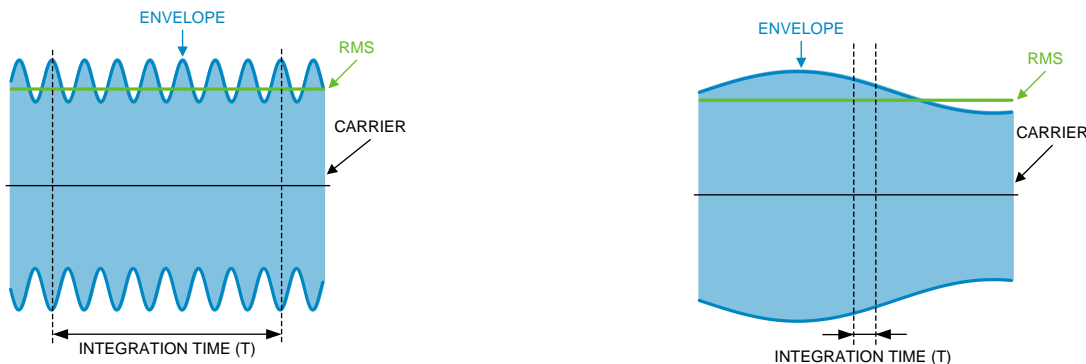

a. RF detector has a constant output

b. RF detector tracks envelope

**Figure 48. Modulation Bandwidth vs. Integration Time of RF detector**

The most suitable detector for a particular application is mainly determined by the modulation standard and its characteristics. 2G, for instance, works with time-division multiplex. As a result the detector must be able to track the ramp-up and ramp-down of the RF signal in case of PA loop control. The detector should have a short response time to handle this.

3G standards like W-CDMA have a constant modulation bandwidth of 5 MHz and a code-division multiplex approach, i.e., continuous transmission. RMS detectors are tailored towards these signal characteristics because they integrate long enough to obtain the actual RMS voltage, i.e.,  $T \gg 1/(5 \text{ MHz})$ .

4G standards like LTE can vary in modulation bandwidth. An example of a signal with low modulation bandwidth is LTE with 1 resource block (RB). It has a modulation bandwidth of 200 kHz. An RMS detector would need to average over  $T \gg 1/(200 \text{ kHz})$ , which is on the order of tens of micro seconds. In contrast a 100 RB signal has a 20 MHz bandwidth which needs an averaging time  $T \gg 1/(20 \text{ MHz})$ . Depending on the modulation bandwidth a different detector would be appropriate. For low modulation bandwidths (low RBs), the integration time of the RMS detector would be long. This is usually too long, and therefore an envelope detector is used instead. For high RBs an RMS detector would work.



## TYPES OF RF DETECTORS

This section provides an overview of detectors based on their detection principle. Detectors that will be discussed are:

- [LOG AMP DETECTORS](#)
- [RMS DETECTORS](#)
- [ENVELOPE DETECTORS](#)

### LOG AMP DETECTORS

LOG Amp detectors are widely used RF power detectors for GSM and the early W-CDMA systems. The transfer function of a LOG amp detector is linear-in-dB, which means that the output in volts changes linearly with the RF power in dBm. This is convenient since most communication standards specify transmit power levels in dBm as well. LOG amp detectors implement the logarithmic function by a piecewise linear approximation. Consequently, the LOG amp detector does not implement an exact power measurement, which implies a dependency on the signal shape. In systems using various modulation schemes calibration and lookup tables might be required.

### RMS DETECTORS

An RMS detector has a response ( $V_{RMS}$ ) that is insensitive to the signal shape and modulation form. This is because its operation is based on the definition of the average power, i.e., it implements:

$$V_{RMS} = \sqrt{\frac{1}{T} \int_0^T v(t)^2 dt} \propto \sqrt{P} \quad (4)$$

RMS detectors are particularly suited for newer communication standards like W-CDMA and LTE that exhibit large peak-to-average ratios and different modulation schemes (signal shapes). This is a key advantage compared to other types of detectors in applications that employ signals with high peak-to-average power variations or different modulation schemes. For example, the RMS detector response to a 0 dBm modulated W-CDMA signal and a 0 dBm unmodulated carrier is essentially equal. This eliminates the need for long calibration procedures and large calibration tables in the application due to different applied modulation schemes.

### ENVELOPE DETECTORS

An envelope detector is a fast-responding detector capable of following the envelope of a modulated RF carrier. This in contrast to other detectors that give the peak, average or RMS voltage. Envelope detectors are particularly useful in communication systems where a fast control of the PA output power is desired, such as LTE. A fast responding power detector enables a power measurement during the 50  $\mu$ s power transition time at the beginning of a transmission slot. As a result the transmit power level can be set accurately before transmission starts.

A commonly used fast-responding RF power detector is a diode detector. A diode detector is typically used with a relatively long holding time when compared to the carrier frequency and a relatively short holding time with respect to the envelope frequency. In this way a diode detector is used as AM demodulator or envelope tracker ([Figure 49](#)).

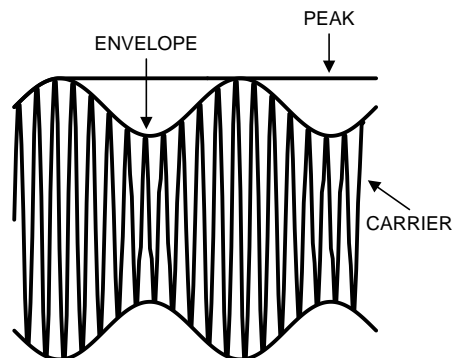
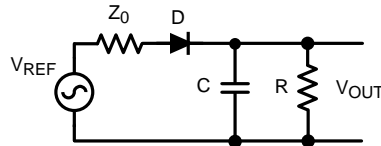

Figure 49. Peak Detection vs. Envelope Tracking

An example of a diode detector is depicted in [Figure 50](#). The diode rectifies the RF input voltage; subsequently, the RC filter determines the averaging (holding) time. The selection of the holding time configures the diode detector for its particular application. For envelope tracking a relatively small RC time constant is chosen such that the output voltage tracks the envelope nicely. In contrast, a configuration with a relatively large time constant for RC measures the maximum (peak) voltage of a signal, see [Figure 49](#).

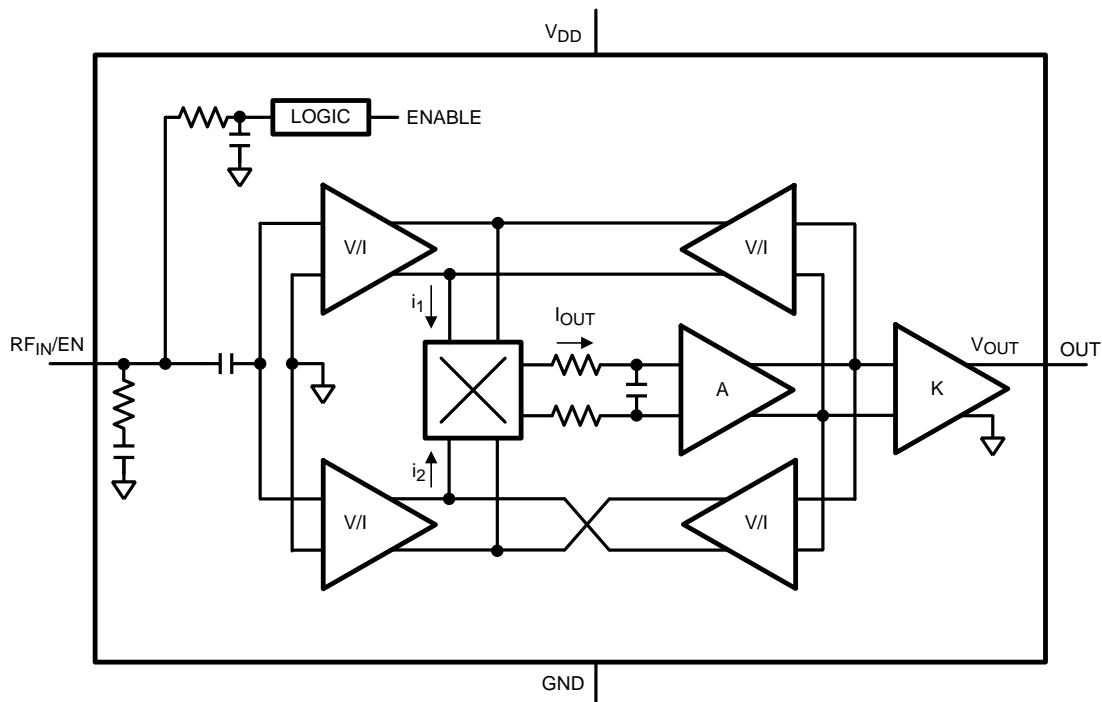

**Figure 50. Diode Detector**

A limitation of the diode detector is its relative small dynamic range. The LMH2121 is an envelope detector with high dynamic range and will be discussed next.

### LMH2121 RF POWER DETECTOR

For optimal performance, the LMH2121 should to be configured correctly in the application. The detector will be discussed by means of its block diagram ([Figure 51](#)). Details of the electrical interfacing are separately discussed for each pin below.



**Figure 51. Block Diagram of LMH2121**

For measuring the power level of a signal, the time average of the squared signal needs to be measured as described in section [ACCURATE POWER MEASUREMENT](#). This is implemented in the LMH2121 by means of a multiplier and a low-pass filter in a negative-feedback loop. A simplified block diagram of the LMH2121 is depicted in [Figure 51](#). The core of the loop is a multiplier. The two inputs of the multiplier are fed by ( $i_1$ ,  $i_2$ ):

$$i_1 = i_{LF} + i_{RF} \quad (5)$$

$$i_2 = i_{LF} - i_{RF} \quad (6)$$

in which  $i_{LF}$  is a current depending on the DC output voltage of the RF detector (made by the V/I converter) and  $i_{RF}$  is a current depending on the RF input signal (made by a V/I converter as well). The output of the multiplier ( $i_{OUT}$ ) is the product of these two currents and equals:

$$i_{\text{OUT}} = \frac{i_{\text{LF}}^2 - i_{\text{RF}}^2}{I_0} \quad (7)$$

in which  $I_0$  is a normalizing current. By using a low-pass filter at the output of the multiplier the DC term of this current is isolated and integrated. The input of amplifier A acts as the nulling point of the negative feedback loop, yielding:

$$\int i_{\text{LF}}^2 dt = \int i_{\text{RF}}^2 dt \quad (8)$$

which implies that the average power content of the current related to the output voltage of the LMH2121 is made equal to the average power content of the current related to the RF input signal.

For a negative-feedback system, the transfer function is given by the inverse function of the feedback block. Therefore, to have a linear conversion gain for this RF detector, the feedback network implements a linear function as well resulting in an overall transfer function for the LMH2121 of:

$$V_{\text{OUT}} = k \sqrt{\int v_{\text{RF}}^2 dt} \quad (9)$$

in which  $k$  is the conversion gain. Note that as a result of the feedback loop the square root is implemented.

The envelope response time of this fast-responding RF detector is given by the gain-bandwidth product of the feedback loop.

Given this architecture for the RF detector, the high performance of the LMH2121 can be understood. In theory the accuracy of the linear transfer function is set by:

- The linear feedback network, which basically needs to process a DC signal only.
- A high loop gain for the feedback loop, which is ensured by the high amplifier gain A.

The square-root functionality is inherent to the feedback loop and the use of a multiplier. Therefore, a very accurate relation between the power content of the input signal and the output is obtained.

## RF Input and Enable

To minimize pin-count, in this case, only 4, the RF input and the enable functionality are combined into one pin. The RF signal is supplied to the RF<sub>IN</sub>/EN pin via an external capacitor, while the Enable signal is connected via a resistor to the RF<sub>IN</sub>/EN pin (see [TYPICAL APPLICATION](#) on the front page). Internally there is an AC path for the RF signal and a DC path for the enable voltage. Care should be taken with the selection of capacitor C. The turn-on time of the RF detector will increase when a large capacitor value is chosen. This is because the capacitor forms a time constant together with resistor R<sub>2</sub>. A capacitor value of 100 pF and resistor value of 1 kΩ is recommended which hardly impacts the turn-on time for those values. The turn-on time is mainly determined by the device itself.

RF systems typically use a characteristic impedance of 50Ω; the LMH2121 is no exception to this. The 50Ω input impedance enables an easy, direct connection to a directional coupler without the need for impedance adjustments. Please note that as a result of the internal AC coupling the 50ohm is not obtained for the complete DC to HF range. However, the input impedance does approximate 50Ω at the usual transmit bands.

The LMH2121 can be brought into a low power consumption shutdown mode by means of the DC enable level which is supplied via a resistor to the RF<sub>IN</sub>/EN pin. The device is active for Enable = HIGH ( $V_{\text{EN}} > 1.1\text{V}$ ), and in the low-power shutdown mode for Enable = LOW ( $V_{\text{EN}} < 0.6\text{V}$ ). In shutdown the output of the LMH2121 is switched to high impedance.

## Output

The output of the LMH2121 provides a DC voltage that is a measure for the applied RF power to the input pin. It tracks the input RF envelope with a 3 dB bandwidth around 2 MHz. The output voltage has a linear-in-V response for an applied RF signal. In active mode the output impedance is 100Ω such that with an external capacitor some filtering can be obtained if necessary. The output impedance of the LMH2121 is high impedance in shutdown. This enables a parallel connection of multiple detector outputs where one of the detectors is enabled at a time.

## Supply

The LMH2121 can handle supply voltages between 2.6V to 3.3V. The high PSRR of the LMH2121 ensures a constant performance over its power supply range.

## DYNAMIC RANGE ALIGNMENT

For an accurate power measurement the signal power range needs to be aligned with the input power range of the LMH2121. When a directional coupler is used, the dynamic range of the power amplifier (PA) and RF detector can be aligned by choosing a coupler with the appropriate coupling factor.

Since the LMH2121 has an input impedance that approximates 50Ω for the useful frequency range, a resistive divider can also be used instead of a directional coupler (Figure 52).

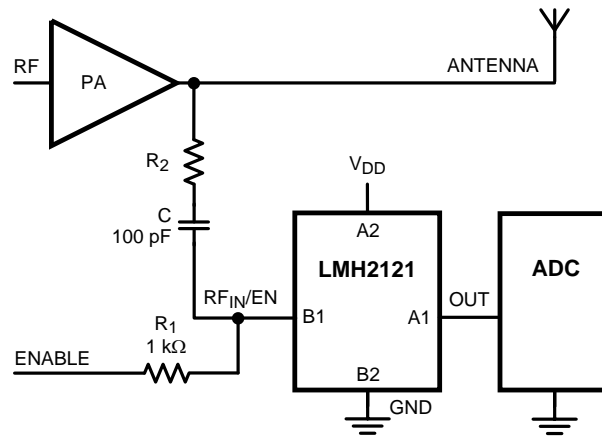

**Figure 52. Dynamic Range Alignment with Resistive Divider**

Resistor  $R_2$  implements an attenuator, together with the detector input impedance. The attenuator can be used to match the signal range with the input range of the LMH2121. The attenuation ( $A_{dB}$ ) realized by  $R_2$  and the effective input resistance ( $R_{IN}$ ) of the LMH2121 equals:

$$A_{dB} = 20 \text{ LOG} \left[ 1 + \frac{R_2}{R_{IN}} \right] \quad (10)$$

Solving this expression for  $R_2$  yields:

$$R_2 = \left[ 10^{\frac{A_{dB}}{20}} - 1 \right] R_{IN} \quad (11)$$

Suppose the desired attenuation is 30 dB with a given LMH2121 input impedance of 50Ω, the resistor  $R_2$  needs to be 1531Ω. A practical value is 1.5 kΩ. Although this is a cheaper solution than the application with directional coupler, it has a disadvantage. After calculating the resistor value it is possible that the realized attenuation is less than expected. This is because of the parasitic capacitance of resistor  $R_2$  which results in a lower actual realized attenuation. Whether the attenuation will be reduced depends on the frequency of the RF signal and the parasitic capacitance of resistor  $R_2$ . Since the parasitic capacitance varies from resistor to resistor, exact determination of the realized attenuation can be difficult. A way to reduce the parasitic capacitance of resistor  $R_2$  is to realize it as a series connection of several separate resistors.

## RESPONSE BANDWIDTH

Modulation standards available today have a wide variety of modulation bandwidths. LTE, for instance, has modulation bandwidths varying from 200 kHz (1RB) up to 20 MHz (100RB). Whether the RF detector can track the envelope of these modulated RF signals depends on its response bandwidth. Figure 53 depicts the response bandwidth of the LMH2121. The plot shows the output as a function of a varying amplitude modulation frequency where the output is normalized to 0 dB at low modulation frequency.

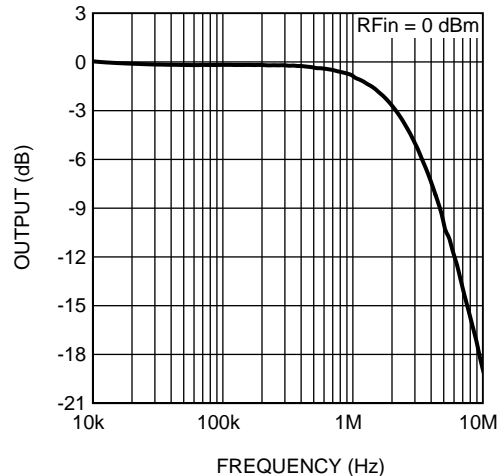

Figure 53. Response Bandwidth

The response bandwidth of the LMH2121 is about 2 MHz for 0 dBm input power level.

## SPECIFYING DETECTOR PERFORMANCE

The performance of the LMH2121 can be expressed by a variety of parameters. This section discusses the key parameters.

### Dynamic Range

The LMH2121 is designed to have a predictable and accurate response over a certain input power range. This is called the dynamic range (DR) of a detector. For determining the dynamic range a couple of different criteria can be used. The most commonly used ones are:

- Linear conformance error,  $E_{LC}$
- Variation over temperature error,  $E_{VOT}$

The specified dynamic range is the range over which the specified error metric is within a predefined window. An explanation of these errors is given in the following sections.

### Linear Conformance error

The LMH2121 implements a linear detection function. In order to describe how close the transfer is to an ideal linear function the linear conformance error is used. To calculate the linear conformance error the detector transfer function can be modeled as a linear function between input power in dBm and output voltage in dBV.

The ideal linear transfer is modeled by 2 parameters:

- Slope,  $K_{SLOPE}$
- Intercept,  $P_{INT}$

and is described by:

$$V_{OUT} = K_{SLOPE} (P_{IN} - P_{INT}) \quad (12)$$

where  $V_{OUT}$  is the output voltage in dBV,  $K_{SLOPE}$  is the slope of the function in dB/dB,  $P_{IN}$  the input power level in dBm and  $P_{INT}$  is the power level in dBm at which the function intersects  $V_{OUT} = 0$  dBV = 1V (See Figure 54).

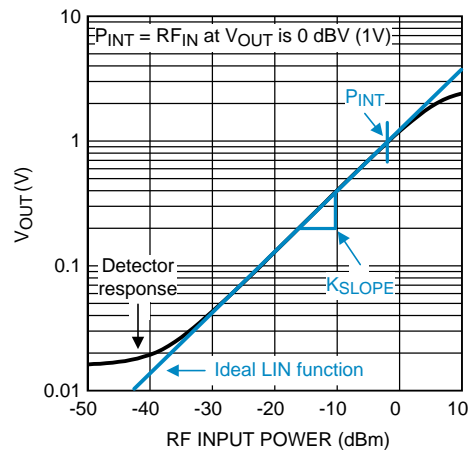

**Figure 54. Comparing Actual Transfer with an Ideal Linear Transfer**

To determine the linear conformance error two steps are required:

1. Determine the best fitted ideal transfer at 25°C.
2. Determine the difference between the actual data and the best fitted ideal transfer.

The best fit can be determined by standard routines. A careful selection of the fit range is important. The fit range should be within the normal range of operation of the device. Outcome of the fit is  $K_{SLOPE}$  and  $P_{INT}$ .

Subsequently, the difference between the actual data and the best fitted ideal transfer is determined. The linear conformance is specified as an input referred error. The output referred error is therefore divided by the  $K_{SLOPE}$  to obtain the input referred error. The linear conformance error is calculated by the following equation:

$$E_{LC}(T) = \frac{V_{OUT}(T) - K_{SLOPE}(25^{\circ}C) [P_{IN} - P_{INT}(25^{\circ}C)]}{K_{SLOPE}(25^{\circ}C)} \tag{13}$$

where  $V_{OUT}(T)$  is the measured output voltage at temperature T, for a power level  $P_{IN}$ .  $K_{SLOPE}25^{\circ}C$  (dB/dB) and  $P_{INT}25^{\circ}C$  (dBm) are the parameters of the best fitted ideal transfer for the actual transfer at 25°C.

Figure 55 shows that both the error with respect to the ideal linear response as well as the error due to temperature variation are included in this error metric. This is because the measured data for all temperatures is compared to the fitted line at 25°C. The measurement result of a typical LMH2121 in Figure 55 shows a dynamic range of 27 dB for  $E_{LC} = \pm 1$ dB over the operating temperature range.

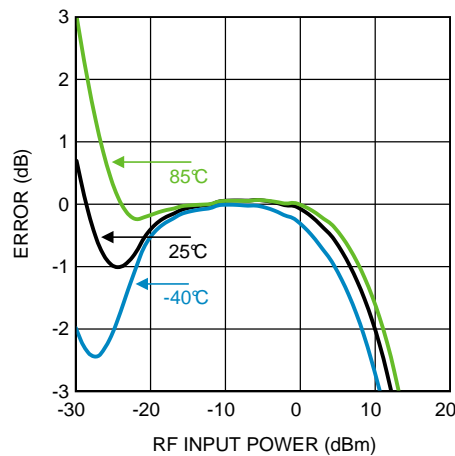

**Figure 55.  $E_{LC}$  vs. RF input Power at 1900 MHz**

**Variation over Temperature Error**

In contrast to the linear conformance error, the variation over temperature error ( $E_{VOT}$ ) purely measures the error due to temperature variation. The measured output voltage at 25°C is subtracted from the output voltage at another temperature for the same power level. Subsequently, the difference is translated into an input referred error by dividing it by  $K_{SLOPE}$  at 25°C. The equation for variation over temperature is given by:

$$E_{VOT}(T) = [ V_{OUT}(T) - V_{OUT}(25^{\circ}C) ] / K_{SLOPE}(25^{\circ}C) \tag{14}$$

The variation over temperature is shown in Figure 56, where a dynamic range of 29 dB is obtained for  $E_{VOT} = \pm 0.5$  dB.

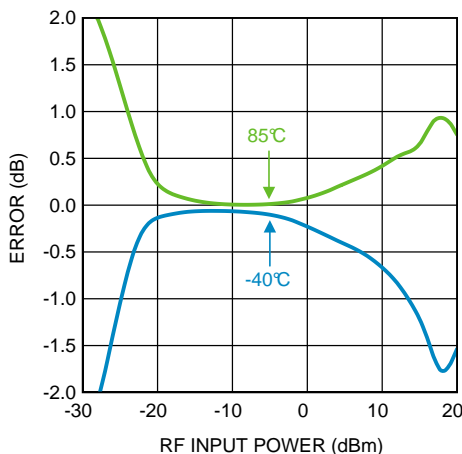

**Figure 56.  $E_{VOT}$  vs. RF Input Power at 1900 MHz**

**Dynamic Range Improvement**

The LMH2121 has a very low part-to-part variation. This implies that compensation for systematic imperfection would be beneficial. One example is to compensate with the typical  $E_{LC}$  for 25°C of the LMH2121. This would correct for systematic bending at the lower- and top ends of the curve. As a result a significant improvement of the dynamic range can be achieved. Figure 57 shows the  $E_{LC}$  before and after compensation. The figure after compensation shows the resulting  $E_{LC}$  of 50 units when the typical  $E_{LC}$  curve is subtracted from each of the 50  $E_{LC}$  curves.

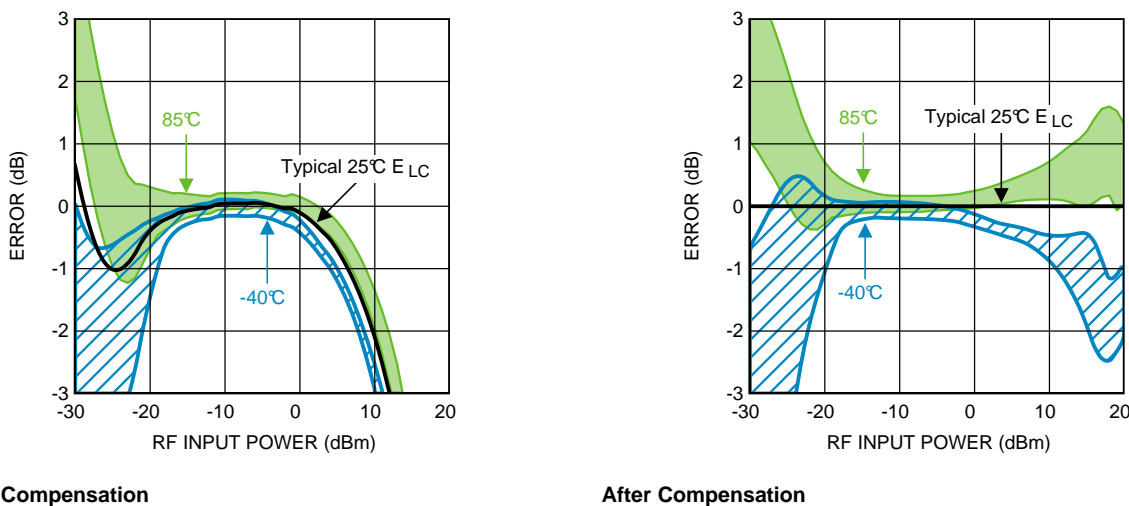
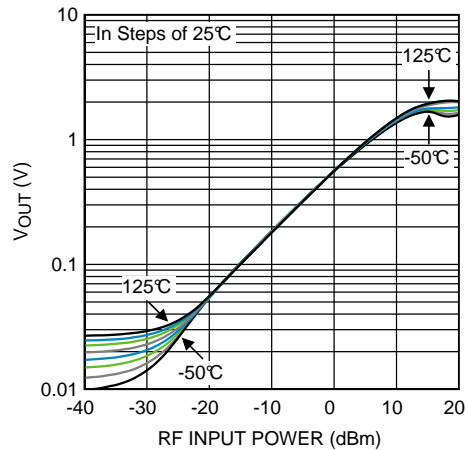

**Figure 57.  $E_{LC}$  vs. RF Input Power**

With this technique a dynamic range improvement of 10 dB is obtained. Likewise  $E_{VOT}$  compensation can be done to move a larger portion of the error band within the  $\pm 0.5$  dB, for instance.

## Temperature Behavior

The specified temperature range of the LMH2121 is from  $-40^{\circ}\text{C}$  to  $85^{\circ}\text{C}$ . The RF detector is, to a certain extent however, still functional outside these temperature limits. Figure 58 and Figure 59 show the detector behavior for temperatures from  $-50^{\circ}\text{C}$  up to  $125^{\circ}\text{C}$  in steps of  $25^{\circ}\text{C}$ . The LMH2121 is still very accurate within a dynamic range from  $-28\text{ dBm}$  to  $+12\text{ dBm}$ . On the upper and lower ends the curves deviate in a gradual way, the lowest temperature at the bottom side and the highest temperature at top side.



**Figure 58.  $V_{\text{OUT}}$  vs. RF Input Power at 1900 MHz for Extended Temperature Range**

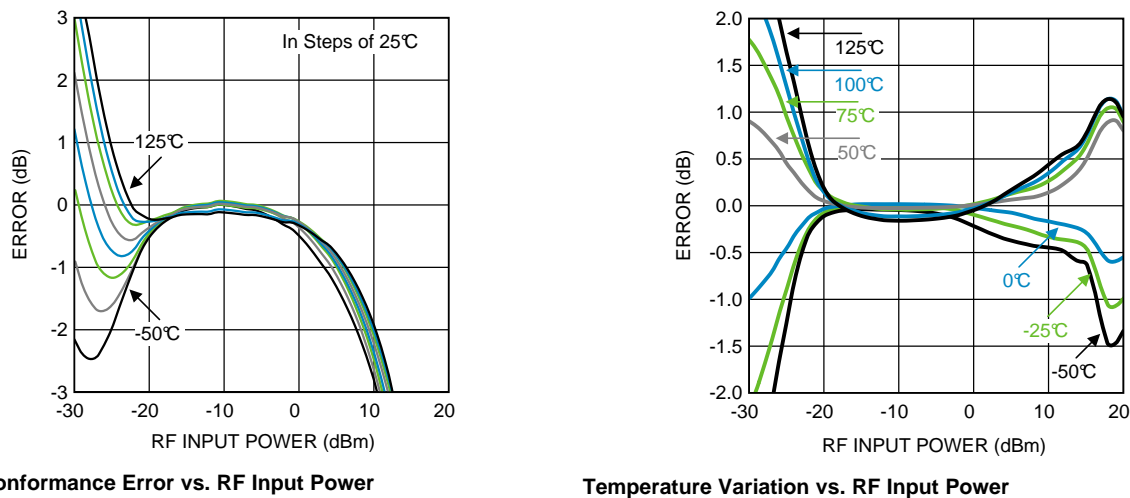

**Linear Conformance Error vs. RF Input Power**

**Temperature Variation vs. RF Input Power**

**Figure 59. Linear Conformance and Temperature Variation vs. RF Input Power at 1900 MHz for Extended Temperature Range**

## Layout Recommendations

As with any other RF device, careful attention must be paid to the board layout. If the board layout isn't properly designed, performance might be less than can be expected for the application.

The LMH2121 is designed to be used in RF applications having a characteristic impedance of  $50\Omega$ . To achieve this impedance, the input of the LMH2121 needs to be connected via a  $50\Omega$  transmission line. Transmission lines can be created on PCBs using microstrip or (grounded) coplanar waveguide (GCPW) configurations.

In order to minimize injection of RF interference into the LMH2121 through the supply lines, the PCB traces for  $V_{\text{DD}}$  and GND should be minimized for RF signals. This can be done by placing a decoupling capacitor between the  $V_{\text{DD}}$  and GND. It should be placed as close as possible to the  $V_{\text{DD}}$  and GND pins of the LMH2121.



---

**REVISION HISTORY**

<b>Changes from Original (March 2013) to Revision A</b>	<b>Page</b>
<hr/> <ul style="list-style-type: none"><li>• Changed layout of National Data Sheet to TI format .....</li></ul>	<hr/> <a href="#">24</a>

**PACKAGING INFORMATION**

Orderable Device	Status (1)	Package Type	Package Drawing	Pins	Package Qty	Eco Plan (2)	Lead/Ball Finish	MSL Peak Temp (3)	Op Temp (°C)	Top-Side Markings (4)	Samples
LMH2121TME	PREVIEW			4		TBD	Call TI	Call TI	-40 to 85		
LMH2121TME/NOPB	ACTIVE	DSBGA	YFQ	4	250	Green (RoHS & no Sb/Br)	SNAGCU	Level-1-260C-UNLIM			<a href="#">Samples</a>
LMH2121TMX/NOPB	ACTIVE	DSBGA	YFQ	4	3000	Green (RoHS & no Sb/Br)	SNAGCU	Level-1-260C-UNLIM			<a href="#">Samples</a>

(1) The marketing status values are defined as follows:

**ACTIVE:** Product device recommended for new designs.

**LIFEBUY:** TI has announced that the device will be discontinued, and a lifetime-buy period is in effect.

**NRND:** Not recommended for new designs. Device is in production to support existing customers, but TI does not recommend using this part in a new design.

**PREVIEW:** Device has been announced but is not in production. Samples may or may not be available.

**OBSOLETE:** TI has discontinued the production of the device.

(2) Eco Plan - The planned eco-friendly classification: Pb-Free (RoHS), Pb-Free (RoHS Exempt), or Green (RoHS & no Sb/Br) - please check <http://www.ti.com/productcontent> for the latest availability information and additional product content details.

**TBD:** The Pb-Free/Green conversion plan has not been defined.

**Pb-Free (RoHS):** TI's terms "Lead-Free" or "Pb-Free" mean semiconductor products that are compatible with the current RoHS requirements for all 6 substances, including the requirement that lead not exceed 0.1% by weight in homogeneous materials. Where designed to be soldered at high temperatures, TI Pb-Free products are suitable for use in specified lead-free processes.

**Pb-Free (RoHS Exempt):** This component has a RoHS exemption for either 1) lead-based flip-chip solder bumps used between the die and package, or 2) lead-based die adhesive used between the die and leadframe. The component is otherwise considered Pb-Free (RoHS compatible) as defined above.

**Green (RoHS & no Sb/Br):** TI defines "Green" to mean Pb-Free (RoHS compatible), and free of Bromine (Br) and Antimony (Sb) based flame retardants (Br or Sb do not exceed 0.1% by weight in homogeneous material)

(3) MSL, Peak Temp. -- The Moisture Sensitivity Level rating according to the JEDEC industry standard classifications, and peak solder temperature.

(4) Multiple Top-Side Markings will be inside parentheses. Only one Top-Side Marking contained in parentheses and separated by a "~" will appear on a device. If a line is indented then it is a continuation of the previous line and the two combined represent the entire Top-Side Marking for that device.

**Important Information and Disclaimer:** The information provided on this page represents TI's knowledge and belief as of the date that it is provided. TI bases its knowledge and belief on information provided by third parties, and makes no representation or warranty as to the accuracy of such information. Efforts are underway to better integrate information from third parties. TI has taken and continues to take reasonable steps to provide representative and accurate information but may not have conducted destructive testing or chemical analysis on incoming materials and chemicals. TI and TI suppliers consider certain information to be proprietary, and thus CAS numbers and other limited information may not be available for release.

In no event shall TI's liability arising out of such information exceed the total purchase price of the TI part(s) at issue in this document sold by TI to Customer on an annual basis.

## TAPE AND REEL INFORMATION



### QUADRANT ASSIGNMENTS FOR PIN 1 ORIENTATION IN TAPE



\*All dimensions are nominal

Device	Package Type	Package Drawing	Pins	SPQ	Reel Diameter (mm)	Reel Width W1 (mm)	A0 (mm)	B0 (mm)	K0 (mm)	P1 (mm)	W (mm)	Pin1 Quadrant
LMH2121TME/NOPB	DSBGA	YFQ	4	250	178.0	8.4	0.94	1.14	0.71	4.0	8.0	Q1
LMH2121TMX/NOPB	DSBGA	YFQ	4	3000	178.0	8.4	0.94	1.14	0.71	4.0	8.0	Q1

**TAPE AND REEL BOX DIMENSIONS**

\*All dimensions are nominal

Device	Package Type	Package Drawing	Pins	SPQ	Length (mm)	Width (mm)	Height (mm)
LMH2121TME/NOPB	DSBGA	YFQ	4	250	210.0	185.0	35.0
LMH2121TMX/NOPB	DSBGA	YFQ	4	3000	210.0	185.0	35.0

YFQ0004

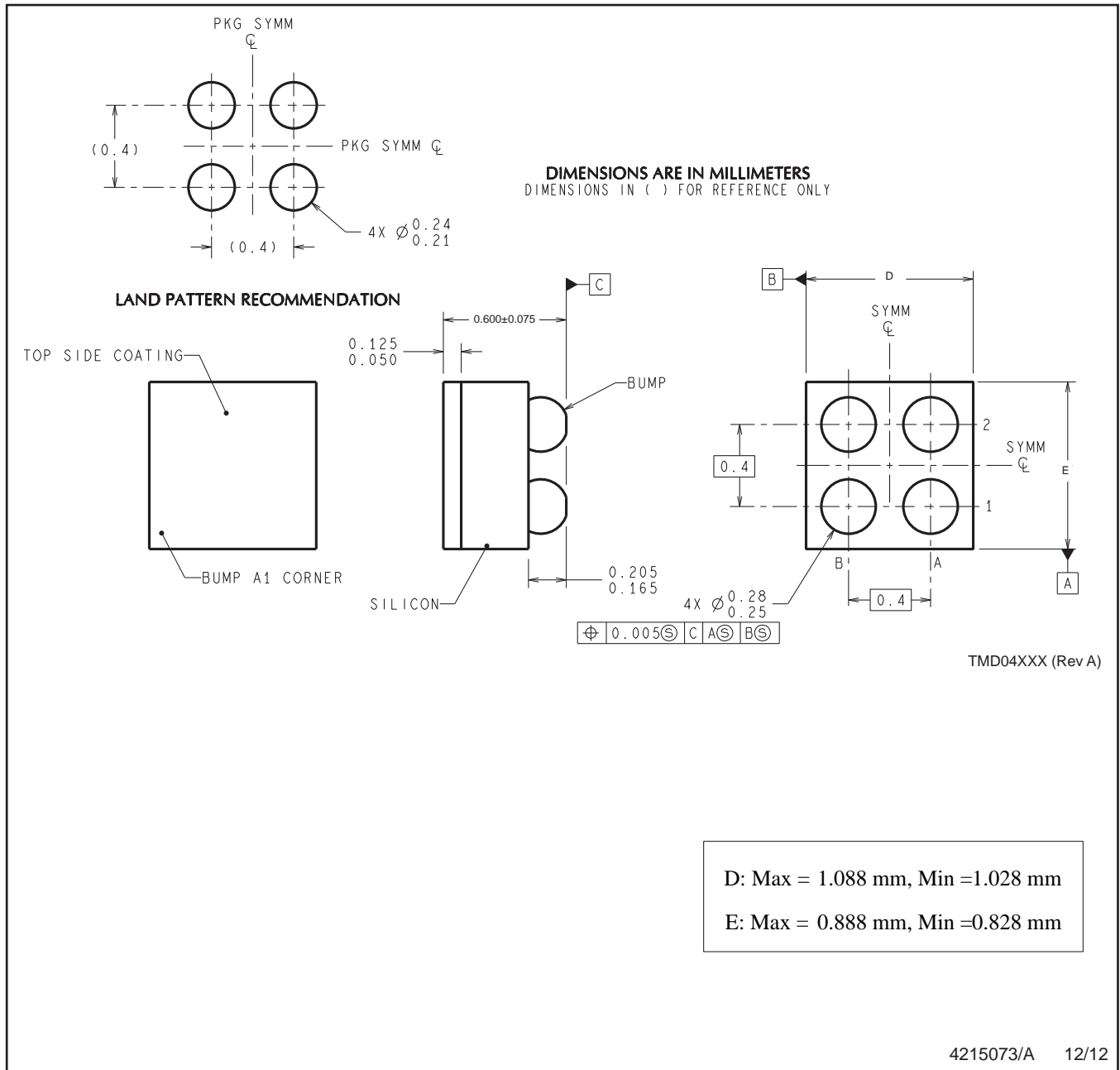

NOTES: A. All linear dimensions are in millimeters. Dimensioning and tolerancing per ASME Y14.5M-1994.  
B. This drawing is subject to change without notice.

## IMPORTANT NOTICE

Texas Instruments Incorporated and its subsidiaries (TI) reserve the right to make corrections, enhancements, improvements and other changes to its semiconductor products and services per JESD46, latest issue, and to discontinue any product or service per JESD48, latest issue. Buyers should obtain the latest relevant information before placing orders and should verify that such information is current and complete. All semiconductor products (also referred to herein as "components") are sold subject to TI's terms and conditions of sale supplied at the time of order acknowledgment.

TI warrants performance of its components to the specifications applicable at the time of sale, in accordance with the warranty in TI's terms and conditions of sale of semiconductor products. Testing and other quality control techniques are used to the extent TI deems necessary to support this warranty. Except where mandated by applicable law, testing of all parameters of each component is not necessarily performed.

TI assumes no liability for applications assistance or the design of Buyers' products. Buyers are responsible for their products and applications using TI components. To minimize the risks associated with Buyers' products and applications, Buyers should provide adequate design and operating safeguards.

TI does not warrant or represent that any license, either express or implied, is granted under any patent right, copyright, mask work right, or other intellectual property right relating to any combination, machine, or process in which TI components or services are used. Information published by TI regarding third-party products or services does not constitute a license to use such products or services or a warranty or endorsement thereof. Use of such information may require a license from a third party under the patents or other intellectual property of the third party, or a license from TI under the patents or other intellectual property of TI.

Reproduction of significant portions of TI information in TI data books or data sheets is permissible only if reproduction is without alteration and is accompanied by all associated warranties, conditions, limitations, and notices. TI is not responsible or liable for such altered documentation. Information of third parties may be subject to additional restrictions.

Resale of TI components or services with statements different from or beyond the parameters stated by TI for that component or service voids all express and any implied warranties for the associated TI component or service and is an unfair and deceptive business practice. TI is not responsible or liable for any such statements.

Buyer acknowledges and agrees that it is solely responsible for compliance with all legal, regulatory and safety-related requirements concerning its products, and any use of TI components in its applications, notwithstanding any applications-related information or support that may be provided by TI. Buyer represents and agrees that it has all the necessary expertise to create and implement safeguards which anticipate dangerous consequences of failures, monitor failures and their consequences, lessen the likelihood of failures that might cause harm and take appropriate remedial actions. Buyer will fully indemnify TI and its representatives against any damages arising out of the use of any TI components in safety-critical applications.

In some cases, TI components may be promoted specifically to facilitate safety-related applications. With such components, TI's goal is to help enable customers to design and create their own end-product solutions that meet applicable functional safety standards and requirements. Nonetheless, such components are subject to these terms.

No TI components are authorized for use in FDA Class III (or similar life-critical medical equipment) unless authorized officers of the parties have executed a special agreement specifically governing such use.

Only those TI components which TI has specifically designated as military grade or "enhanced plastic" are designed and intended for use in military/aerospace applications or environments. Buyer acknowledges and agrees that any military or aerospace use of TI components which have **not** been so designated is solely at the Buyer's risk, and that Buyer is solely responsible for compliance with all legal and regulatory requirements in connection with such use.

TI has specifically designated certain components as meeting ISO/TS16949 requirements, mainly for automotive use. In any case of use of non-designated products, TI will not be responsible for any failure to meet ISO/TS16949.

### Products

Audio	<a href="http://www.ti.com/audio">www.ti.com/audio</a>
Amplifiers	<a href="http://amplifier.ti.com">amplifier.ti.com</a>
Data Converters	<a href="http://dataconverter.ti.com">dataconverter.ti.com</a>
DLP® Products	<a href="http://www.dlp.com">www.dlp.com</a>
DSP	<a href="http://dsp.ti.com">dsp.ti.com</a>
Clocks and Timers	<a href="http://www.ti.com/clocks">www.ti.com/clocks</a>
Interface	<a href="http://interface.ti.com">interface.ti.com</a>
Logic	<a href="http://logic.ti.com">logic.ti.com</a>
Power Mgmt	<a href="http://power.ti.com">power.ti.com</a>
Microcontrollers	<a href="http://microcontroller.ti.com">microcontroller.ti.com</a>
RFID	<a href="http://www.ti-rfid.com">www.ti-rfid.com</a>
OMAP Applications Processors	<a href="http://www.ti.com/omap">www.ti.com/omap</a>
Wireless Connectivity	<a href="http://www.ti.com/wirelessconnectivity">www.ti.com/wirelessconnectivity</a>

### Applications

Automotive and Transportation	<a href="http://www.ti.com/automotive">www.ti.com/automotive</a>
Communications and Telecom	<a href="http://www.ti.com/communications">www.ti.com/communications</a>
Computers and Peripherals	<a href="http://www.ti.com/computers">www.ti.com/computers</a>
Consumer Electronics	<a href="http://www.ti.com/consumer-apps">www.ti.com/consumer-apps</a>
Energy and Lighting	<a href="http://www.ti.com/energy">www.ti.com/energy</a>
Industrial	<a href="http://www.ti.com/industrial">www.ti.com/industrial</a>
Medical	<a href="http://www.ti.com/medical">www.ti.com/medical</a>
Security	<a href="http://www.ti.com/security">www.ti.com/security</a>
Space, Avionics and Defense	<a href="http://www.ti.com/space-avionics-defense">www.ti.com/space-avionics-defense</a>
Video and Imaging	<a href="http://www.ti.com/video">www.ti.com/video</a>

### TI E2E Community

[e2e.ti.com](http://e2e.ti.com)