

1

2

3

4

5

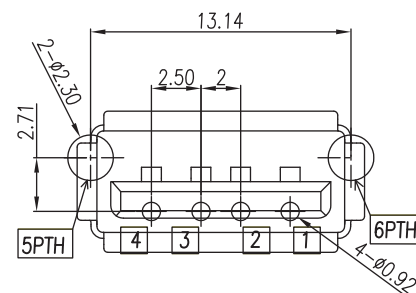
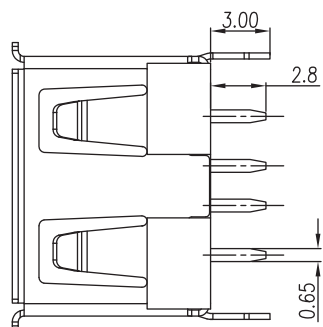

PCB LAYOUT - COMPONENT VIEW
RECOMMENDED PCB THICKNESS : 1.2 mm

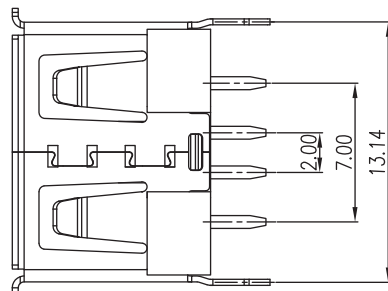
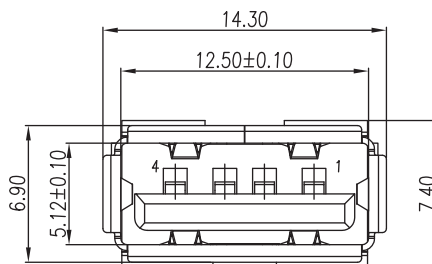
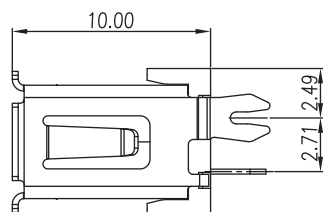
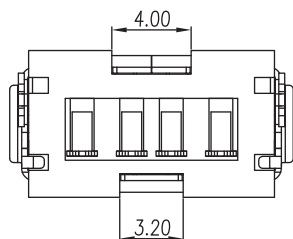

TECHNICAL CHARACTERISTICS

MATERIAL
 INSULATOR: PBT
 FLAMMABILITY RATING: UL94-V0
 COLOR: WHITE
 CONTACT MATERIAL: COPPER ALLOY
 CONTACT PLATING: GOLD OVER Ni
 COVER MATERIAL: BRASS
 COVER PLATING: Ni
 QUALITY CLASS: 1 500 MATING CYCLES

ENVIRONMENTAL
 OPERATING TEMPERATURE: -55°C UP TO +85°C
 COMPLIANCE: LEAD FREE & ROHS

ELECTRICAL
 CURRENT RATING: 1.5A MAX
 WORKING VOLTAGE: 30 VAC MAX
 WITHSTANDING VOLTAGE: 500 VAC/MIN
 INSULATION RESISTANCE: > 1000 MΩ
 CONTACT RESISTANCE: 30 mΩ MAX

MECHANICAL
 INSERTION FORCE: 35 N MAX
 EXTRACTION FORCE: 10 N/MIN

SOLDERING
 JEDEC LEAD FREE WAVE SOLDERING PROCESS

PACKAGING
 TRAY

RoHS Compliant

PROJECTION:

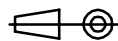

GENERAL TOLERANCE

.X = ± 0.2

.XX = ± 0.15



APPROVAL: NPr

UNIT: MM

DESCRIPTION: USB TYPE A VERTICAL THT - SHORT TYPE

SIZE

20-OCT-15

PACKAGING

AK

SCALE:

WERI PART NO: 614 004 185 023

A4

10-AUG-15

PDF

AK

SHEET: 1/3

REV DATE FILE BY

DRAW: AK

1

2

3

4

5

A

B

C

D

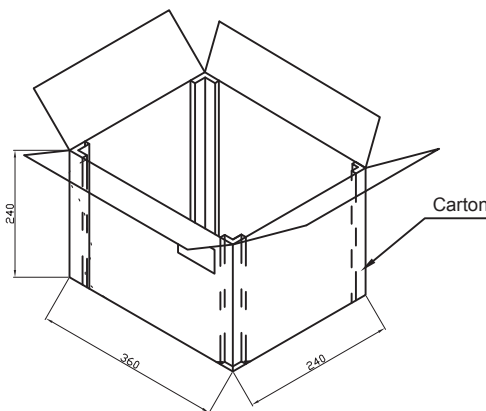
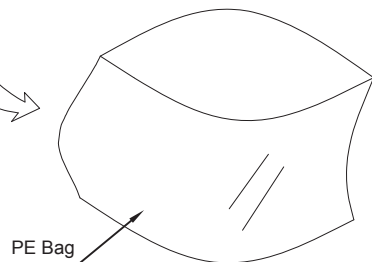
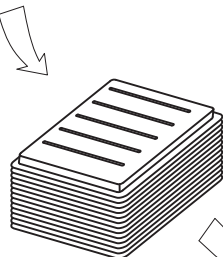
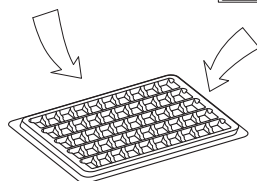
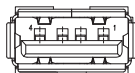
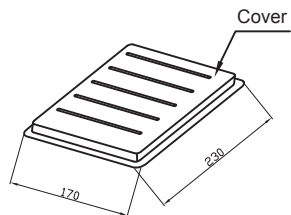

50 pcs/tray
 38 trays/carton
 1900 pcs/carton

RoHS Compliant			
G			
F			
E			
D			
C			
B			
A		PDF	
REV	DATE	FILE	BY

PROJECTION:

GENERAL TOLERANCE
 .X = +/- 0.2
 .XX = +/- 0.15



APPROVAL: NPr

UNIT: MM
 SCALE:
 SHEET: 2/3
 DRAW: AK

DESCRIPTION: USB TYPE A VERTICAL THT - SHORT TYPE
 WERI PART NO: 614 004 185 023

SIZE
A4

1

2

3

4

5

Cautions and Warnings:

This electronic component is designed and developed with the intention for use in general electronics equipments.

Before incorporating the components into any equipments in the field such as aerospace, aviation, nuclear control, submarine, transportation, (automotive control, train control, ship control), transportation signal, disaster prevention, medical, public information network etc. where higher safety and reliability are especially required or if there is possibility of direct damage or injury to human body, Würth Elektronik must be asked for a written approval.

In addition, even electronic component in general electronic equipments, when used in electrical circuits that require high safety, reliability functions or performance, the sufficient reliability evaluation-check for the safety must be performed before by the user before usage.

A

B

C

RoHS Compliant

PROJECTION:



GENERAL TOLERANCE

.X = +/- 0.2

.XX = +/- 0.15



APPROVAL: JC

UNIT: MM

SCALE:

SHEET: 3/3

DRAW: QL



DESCRIPTION: DISCLAIMER

WERI PART NO: DISCLAIMER

SIZE

A4

D

G				PROJECTION: 	GENERAL TOLERANCE .X = +/- 0.2 .XX = +/- 0.15	
F						
E						
D						
C				APPROVAL: JC	UNIT: MM	DESCRIPTION: DISCLAIMER
B					SCALE:	
A	10-SEP-14	PDF	QL		SHEET: 3/3	WERI PART NO: DISCLAIMER
REV	DATE	FILE	BY		DRAW: QL	