



July 2015

MC78LXXA / LM78LXXA

3-Terminal 0.1 A Positive Voltage Regulator

Features

- Maximum Output Current of 100 mA
- Output Voltage of 5 V, 6 V, 8 V, 12 V, and 15 V
- Thermal Overload Protection
- Short-Circuit Current Limiting
- Output Voltage Offered in $\pm 5\%$ Tolerance

Description

The MC78LXXA / LM78LXXA series of fixed-voltage monolithic integrated circuit voltage regulators are suitable for applications that required supply current up to 100 mA.

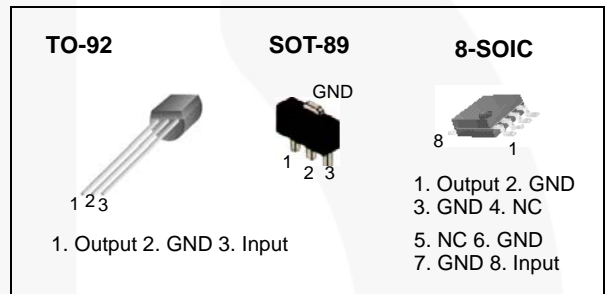

Ordering Information

Product Number	Package	Packing Method	Output Voltage Tolerance	Operating Temperature
LM78L05ACZ	TO-92	Bulk	$\pm 5\%$	-40 to +125°C
LM78L05ACZX		Tape & Reel		
LM78L05ACZXA		Ammo		
LM78L12ACZ		Bulk		
LM78L12ACZX		Tape & Reel		
MC78L05ACP		Bulk		
MC78L05ACPXA		Ammo		
MC78L06ACP		Bulk		
MC78L08ACP		Bulk		
MC78L15ACP		Bulk		
MC78L15ACPXA		Ammo		
MC78L05ACD		8-SOIC		
MC78L05ACDX	Tape & Reel			
MC78L05ACHX	SOT-89	Tape & Reel		
MC78L08ACHX		Tape & Reel		

MC78LXXA / LM78LXXA — 3-Terminal 0.1 A Positive Voltage Regulator

Block Diagram

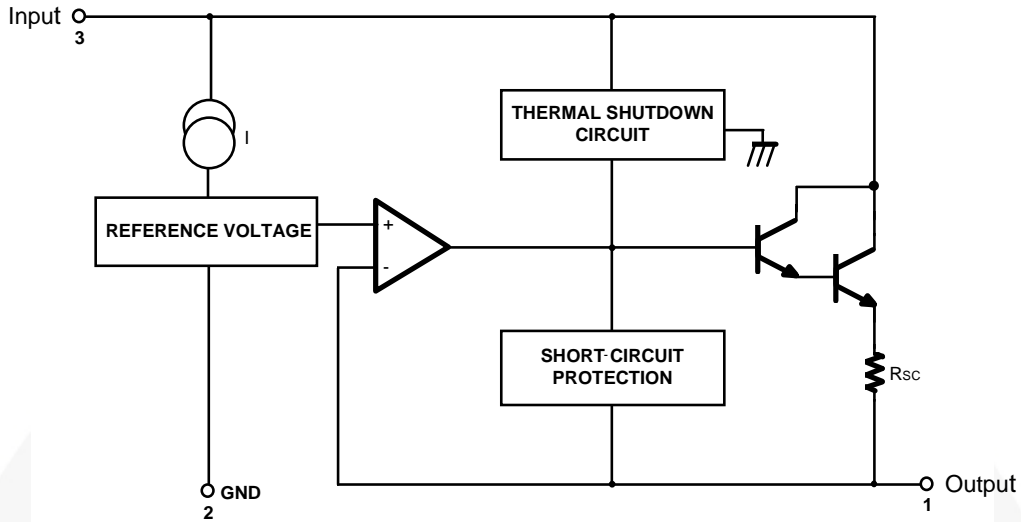

Figure 1. Block Diagram

Absolute Maximum Ratings

Stresses exceeding the absolute maximum ratings may damage the device. The device may not function or be operable above the recommended operating conditions and stressing the parts to these levels is not recommended. In addition, extended exposure to stresses above the recommended operating conditions may affect device reliability. The absolute maximum ratings are stress ratings only. Values are at $T_A = 25^\circ\text{C}$ unless otherwise noted.

Symbol	Parameter		Value	Unit
V_I	Input Voltage	$V_O = 5\text{ V to }8\text{ V}$	30	V
		$V_O = 12\text{ V to }15\text{ V}$	35	V
T_{OPR}	Operating Temperature Range		-40 to +125°C	°C
$T_{\text{J(MAX)}}$	Maximum Junction Temperature		150	°C
T_{STG}	Storage Temperature Range		-65 to +150	°C
$R_{\theta\text{JC}}$	Thermal Resistance, Junction-Case	TO-92	50	°C/W
$R_{\theta\text{JA}}$	Thermal Resistance, Junction-Air	TO-92	150	°C/W
		SOT-89	225	°C/W
		8-SOIC	160	°C/W

Electrical Characteristics (MC78L05A / LM78L05A)

$V_I = 10\text{ V}$, $I_O = 40\text{ mA}$, $-40^\circ\text{C} \leq T_J \leq 125^\circ\text{C}$, $C_I = 0.33\ \mu\text{F}$, $C_O = 0.1\ \mu\text{F}$, unless otherwise specified.

Symbol	Parameter	Conditions	Min.	Typ.	Max.	Unit	
V_O	Output Voltage	$T_J = 25^\circ\text{C}$	4.8	5.0	5.2	V	
ΔV_O	Line Regulation ⁽¹⁾	$T_J = 25^\circ\text{C}$	$7\text{ V} \leq V_I \leq 20\text{ V}$		8	150	mV
			$8\text{ V} \leq V_I \leq 20\text{ V}$		6	100	mV
ΔV_O	Load Regulation ⁽¹⁾	$T_J = 25^\circ\text{C}$	$1\text{ mA} \leq I_O \leq 100\text{ mA}$		11	60	mV
			$1\text{ mA} \leq I_O \leq 40\text{ mA}$		5.0	30.0	mV
V_O	Output Voltage	$7\text{ V} \leq V_I \leq 20\text{ V}$	$1\text{ mA} \leq I_O \leq 40\text{ mA}$			5.25	V
		$7\text{ V} \leq V_I \leq V_{\text{MAX}}^{(2)}$	$1\text{ mA} \leq I_O \leq 70\text{ mA}$	4.75		5.25	V
I_Q	Quiescent Current	$T_J = 25^\circ\text{C}$		2.0	5.5	mA	
ΔI_Q	Quiescent Current Change	With Line	$8\text{ V} \leq V_I \leq 20\text{ V}$			1.5	mA
ΔI_Q		With Load	$1\text{ mA} \leq I_O \leq 40\text{ mA}$			0.1	mA
V_N	Output Noise Voltage	$T_A = 25^\circ\text{C}$, $10\text{ Hz} \leq f \leq 100\text{ kHz}$		40		$\mu\text{V}/V_O$	
$\Delta V_O/\Delta T$	Temperature Coefficient of V_O	$I_O = 5\text{ mA}$		-0.65		$\text{mV}/^\circ\text{C}$	
RR	Ripple Rejection	$f = 120\text{ Hz}$, $8\text{ V} \leq V_I \leq 18\text{ V}$, $T_J = 25^\circ\text{C}$	41	80		dB	
V_D	Dropout Voltage	$T_J = 25^\circ\text{C}$		1.7		V	

Notes:

1. The maximum steady-state usable output current and input voltage are very dependent on the heat sinking and/or lead length of the package. The data above represents pulse test conditions with junction temperature as indicated at the initiation of tests.
2. Power dissipation $P_D \leq 0.75\text{ W}$.

Electrical Characteristics (MC78L06A)

$V_I = 12\text{ V}$, $I_O = 40\text{ mA}$, $-40^\circ\text{C} \leq T_J \leq 125^\circ\text{C}$, $C_I = 0.33\ \mu\text{F}$, $C_O = 0.1\ \mu\text{F}$, unless otherwise specified.

Symbol	Parameter	Conditions	Min.	Typ.	Max.	Unit	
V_O	Output Voltage	$T_J = 25^\circ\text{C}$	5.75	6.0	6.25	V	
ΔV_O	Line Regulation ⁽³⁾	$T_J = 25^\circ\text{C}$	$8.5\text{ V} \leq V_I \leq 20\text{ V}$		64	175	mV
			$9\text{ V} \leq V_I \leq 20\text{ V}$		54	125	mV
ΔV_O	Load Regulation ⁽³⁾	$T_J = 25^\circ\text{C}$	$1\text{ mA} \leq I_O \leq 100\text{ mA}$		12.8	80.0	mV
			$1\text{ mA} \leq I_O \leq 70\text{ mA}$		5.8	40.0	mV
V_O	Output Voltage		$8.5\text{ V} \leq V_I \leq 20\text{ V}$, $1\text{ mA} \leq I_O \leq 40\text{ mA}$	5.7		6.3	V
			$8.5\text{ V} \leq V_I \leq V_{\text{MAX}}^{(4)}$, $1\text{ mA} \leq I_O \leq 70\text{ mA}$	5.7		6.3	V
I_Q	Quiescent Current			$T_J = 25^\circ\text{C}$		5.5	mA
				$T_J = 125^\circ\text{C}$		3.9	6.0
ΔI_Q	Quiescent Current Change	With Line	$9\text{ V} \leq V_I \leq 20\text{ V}$			1.5	mA
ΔI_Q		With Load	$1\text{ mA} \leq I_O \leq 40\text{ mA}$			0.1	mA
V_N	Output Noise Voltage			40		$\mu\text{V}/V_o$	
$\Delta V_O/\Delta T$	Temperature Coefficient of V_O			0.75		$\text{mV}/^\circ\text{C}$	
RR	Ripple Rejection		40	46		dB	
V_D	Dropout Voltage			1.7		V	

Notes:

- The maximum steady-state usable output current and input voltage are very dependent on the heat sinking and/or lead length of the package. The data above represents pulse test conditions with junction temperature as indicated at the initiation of tests.
- Power dissipation $P_D \leq 0.75\text{ W}$.

Electrical Characteristics (MC78L08A)

$V_I = 14\text{ V}$, $I_O = 40\text{ mA}$, $-40^\circ\text{C} \leq T_J \leq 125^\circ\text{C}$, $C_I = 0.33\ \mu\text{F}$, $C_O = 0.1\ \mu\text{F}$, unless otherwise specified.

Symbol	Parameter	Conditions	Min.	Typ.	Max.	Unit	
V_O	Output Voltage	$T_J = 25^\circ\text{C}$	7.7	8.0	8.3	V	
ΔV_O	Line Regulation ⁽⁵⁾	$T_J = 25^\circ\text{C}$	$10.5\text{ V} \leq V_I \leq 23\text{ V}$		10	175	mV
			$11\text{ V} \leq V_I \leq 23\text{ V}$		8	125	mV
ΔV_O	Load Regulation ⁽⁵⁾	$T_J = 25^\circ\text{C}$	$1\text{ mA} \leq I_O \leq 100\text{ mA}$		15	80	mV
			$1\text{ mA} \leq I_O \leq 40\text{ mA}$		8	40	mV
V_O	Output Voltage	$10.5\text{V} \leq V_I \leq 23\text{V}$	$1\text{ mA} \leq I_O \leq 40\text{ mA}$	7.6		8.4	V
		$10.5\text{V} \leq V_I \leq V_{\text{MAX}}^{(6)}$	$1\text{ mA} \leq I_O \leq 70\text{ mA}$	7.6		8.4	V
I_Q	Quiescent Current	$T_J = 25^\circ\text{C}$		2.0	5.5	mA	
ΔI_Q	Quiescent Current Change	With Line	$11\text{ V} \leq V_I \leq 23\text{ V}$			1.5	mA
ΔI_Q		With Load	$1\text{ mA} \leq I_O \leq 40\text{ mA}$			0.1	mA
V_N	Output Noise Voltage	$T_A = 25^\circ\text{C}$, $10\text{ Hz} \leq f \leq 100\text{ kHz}$		60		$\mu\text{V}/V_O$	
$\Delta V_O/\Delta T$	Temperature Coefficient of V_O	$I_O = 5\text{ mA}$		-0.8		$\text{mV}/^\circ\text{C}$	
RR	Ripple Rejection	$f = 120\text{ Hz}$, $11\text{ V} \leq V_I \leq 21\text{ V}$, $T_J = 25^\circ\text{C}$	39	70		dB	
V_D	Dropout Voltage	$T_J = 25^\circ\text{C}$		1.7		V	

Notes:

5. The maximum steady-state usable output current and input voltage are very dependent on the heat sinking and/or lead length of the package. The data above represents pulse test conditions with junction temperature as indicated at the initiation of tests.
6. Power dissipation $P_D \leq 0.75\text{ W}$.

Electrical Characteristics (MC78L12A / LM78L12A)

$V_I = 19\text{ V}$, $I_O = 40\text{ mA}$, $-40^\circ\text{C} \leq T_J \leq 125^\circ\text{C}$, $C_I = 0.33\ \mu\text{F}$, $C_O = 0.1\ \mu\text{F}$, unless otherwise specified.

Symbol	Parameter	Conditions	Min.	Typ.	Max.	Unit
V_O	Output Voltage	$T_J = 25^\circ\text{C}$	11.5	12.0	12.5	V
ΔV_O	Line Regulation ⁽⁷⁾	$T_J = 25^\circ\text{C}$	$14.5\text{ V} \leq V_I \leq 27\text{ V}$	20	250	mV
			$16\text{ V} \leq V_I \leq 27\text{ V}$	15	200	mV
ΔV_O	Load Regulation ⁽⁷⁾	$T_J = 25^\circ\text{C}$	$1\text{ mA} \leq I_O \leq 100\text{ mA}$	20	100	mV
			$1\text{ mA} \leq I_O \leq 40\text{ mA}$	10	50	mV
V_O	Output Voltage	$14.5\text{ V} \leq V_I \leq 27\text{ V}$	$1\text{ mA} \leq I_O \leq 40\text{ mA}$	11.4	12.6	V
		$14.5\text{ V} \leq V_I \leq V_{\text{MAX}}^{(8)}$	$1\text{ mA} \leq I_O \leq 70\text{ mA}$	11.4	12.6	V
I_Q	Quiescent Current	$T_J = 25^\circ\text{C}$		2.1	6.0	mA
ΔI_Q	Quiescent Current Change	With Line	$16\text{ V} \leq V_I \leq 27\text{ V}$		1.5	mA
ΔI_Q		With Load	$1\text{ mA} \leq I_O \leq 40\text{ mA}$		0.1	mA
V_N	Output Noise Voltage	$T_A = 25^\circ\text{C}$, $10\text{ Hz} \leq f \leq 100\text{ kHz}$		80		$\mu\text{V}/V_O$
$\Delta V_O/\Delta T$	Temperature Coefficient of V_O	$I_O = 5\text{ mA}$		-1.0		$\text{mV}/^\circ\text{C}$
RR	Ripple Rejection	$f = 120\text{ Hz}$, $15\text{ V} \leq V_I \leq 25\text{ V}$, $T_J = 25^\circ\text{C}$	37	65		dB
V_D	Dropout Voltage	$T_J = 25^\circ\text{C}$		1.7		V

Notes:

7. The maximum steady-state usable output current and input voltage are very dependent on the heat sinking and/or lead length of the package. The data above represents pulse test conditions with junction temperature as indicated at the initiation of tests.
8. Power dissipation $P_D \leq 0.75\text{ W}$.

Electrical Characteristics (MC78L15A)

$V_I = 23\text{ V}$, $I_O = 40\text{ mA}$, $-40^\circ\text{C} \leq T_J \leq 125^\circ\text{C}$, $C_I = 0.33\text{ }\mu\text{F}$, $C_O = 0.1\text{ }\mu\text{F}$, unless otherwise specified.

Symbol	Parameter		Conditions	Min.	Typ.	Max.	Unit
V_O	Output Voltage		$T_J = 25^\circ\text{C}$	14.4	15.0	15.6	V
ΔV_O	Line Regulation ⁽⁹⁾		$T_J = 25^\circ\text{C}$	$17.5\text{ V} \leq V_I \leq 30\text{ V}$	25	300	mV
				$20\text{ V} \leq V_I \leq 30\text{ V}$	20	250	mV
ΔV_O	Load Regulation ⁽⁹⁾		$T_J = 25^\circ\text{C}$	$1\text{ mA} \leq I_O \leq 100\text{ mA}$	25	150	mV
				$1\text{ mA} \leq I_O \leq 40\text{ mA}$	12	75	mV
V_O	Output Voltage		$17.5\text{ V} \leq V_I \leq 30\text{ V}$	$1\text{ mA} \leq I_O \leq 40\text{ mA}$	14.25	15.75	V
			$17.5\text{ V} \leq V_I \leq V_{\text{MAX}}^{(10)}$	$1\text{ mA} \leq I_O \leq 70\text{ mA}$	14.25	15.75	V
I_Q	Quiescent Current		$T_J = 25^\circ\text{C}$		2.1	6.0	mA
ΔI_Q	Quiescent Current Change	With Line	$20\text{ V} \leq V_I \leq 30\text{ V}$			1.5	mA
ΔI_Q		With Load	$1\text{ mA} \leq I_O \leq 40\text{ mA}$			0.1	mA
V_N	Output Noise Voltage		$T_A = 25^\circ\text{C}$, $10\text{ Hz} \leq f \leq 100\text{ kHz}$		90		$\mu\text{V}/V_O$
$\Delta V_O/\Delta T$	Temperature Coefficient of V_O		$I_O = 5\text{ mA}$		-1.3		$\text{mV}/^\circ\text{C}$
RR	Ripple Rejection		$f = 120\text{ Hz}$, $18.5\text{ V} \leq V_I \leq 28.5\text{ V}$, $T_J = 25^\circ\text{C}$	34	60		dB
V_D	Dropout Voltage		$T_J = 25^\circ\text{C}$		1.7		V

Notes:

- The maximum steady-state usable output current and input voltage are very dependent on the heat sinking and/or lead length of the package. The data above represents pulse test conditions with junction temperature as indicated at the initiation of tests.
- Power dissipation $P_D \leq 0.75\text{ W}$.

Typical Application

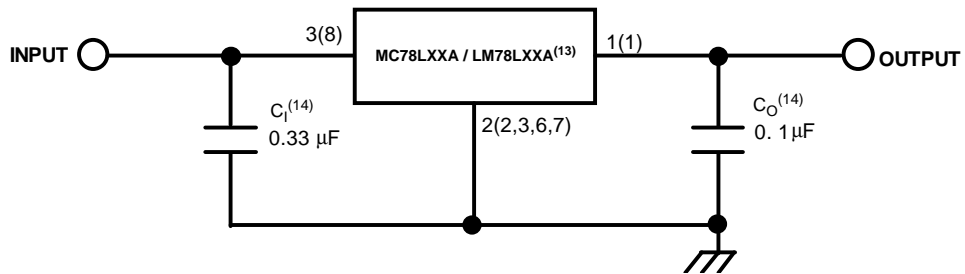
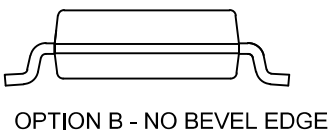
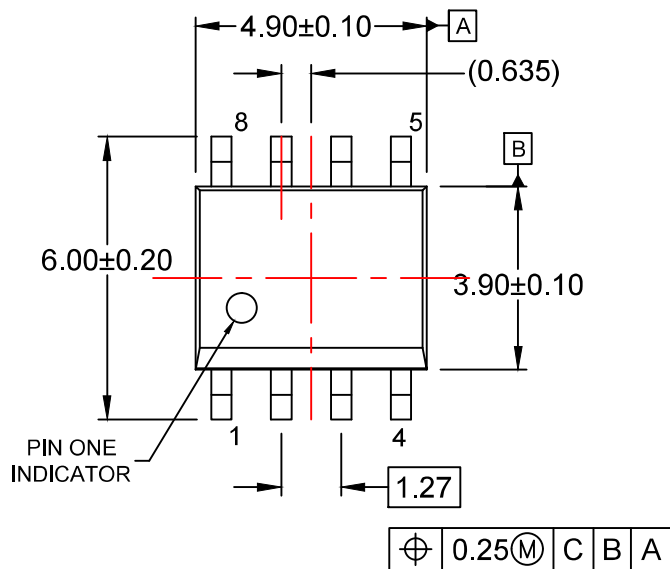

Figure 2. Typical Application

Notes:

13. To specify an output voltage, substitute voltage value for "XX".
14. C_1 is required if the regulator is located an appreciable distance from the power supply filter. Though C_0 is not needed for stability, it improves transient response. Bypass capacitors are recommended for optimum stability and transient response and should be located as close as possible to the regulator.



NOTES:

- A) THIS PACKAGE CONFORMS TO JEDEC MS-012, VARIATION AA.
- B) ALL DIMENSIONS ARE IN MILLIMETERS.
- C) DIMENSIONS DO NOT INCLUDE MOLD FLASH OR BURRS.
- D) LANDPATTERN STANDARD: SOIC127P600X175-8M
- E) DRAWING FILENAME: M08Arev16



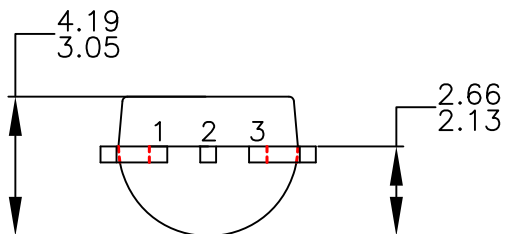
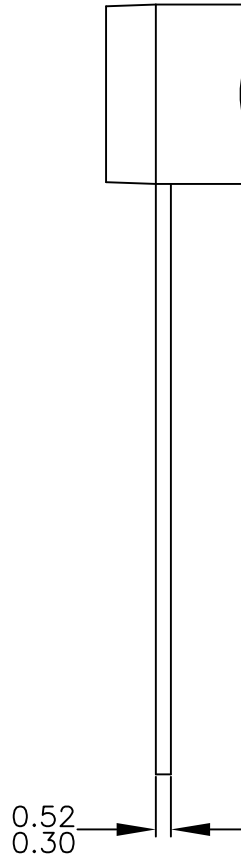
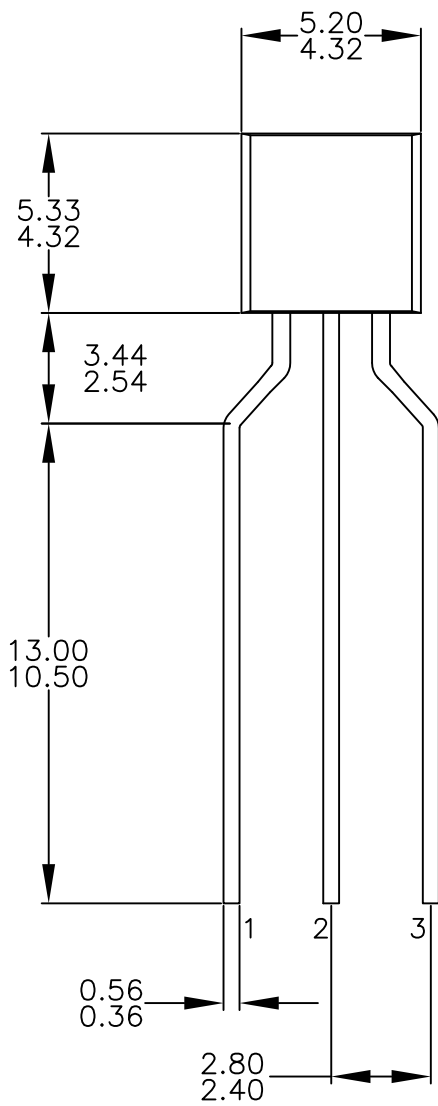

NOTES: UNLESS OTHERWISE SPECIFIED

- A. DRAWING CONFORMS TO JEDEC MS-013, VARIATION AC.
- B. ALL DIMENSIONS ARE IN MILLIMETERS.
- C. DRAWING CONFORMS TO ASME Y14.5M-2009.
- D. DRAWING FILENAME: MKT-ZA03FREV3.
- E. FAIRCHILD SEMICONDUCTOR.

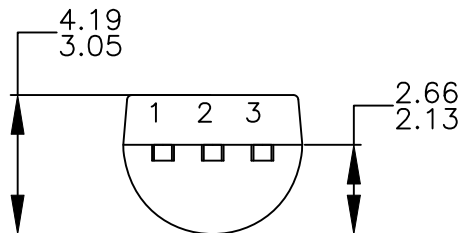

NOTES: UNLESS OTHERWISE SPECIFIED

- A) DRAWING WITH REFERENCE TO JEDEC TO-92 RECOMMENDATIONS.
- B) ALL DIMENSIONS ARE IN MILLIMETERS.
- C) DRAWING CONFORMS TO ASME Y14.5M-2009.
- D) DRAWING FILENAME: MKT-ZA03DREV4.



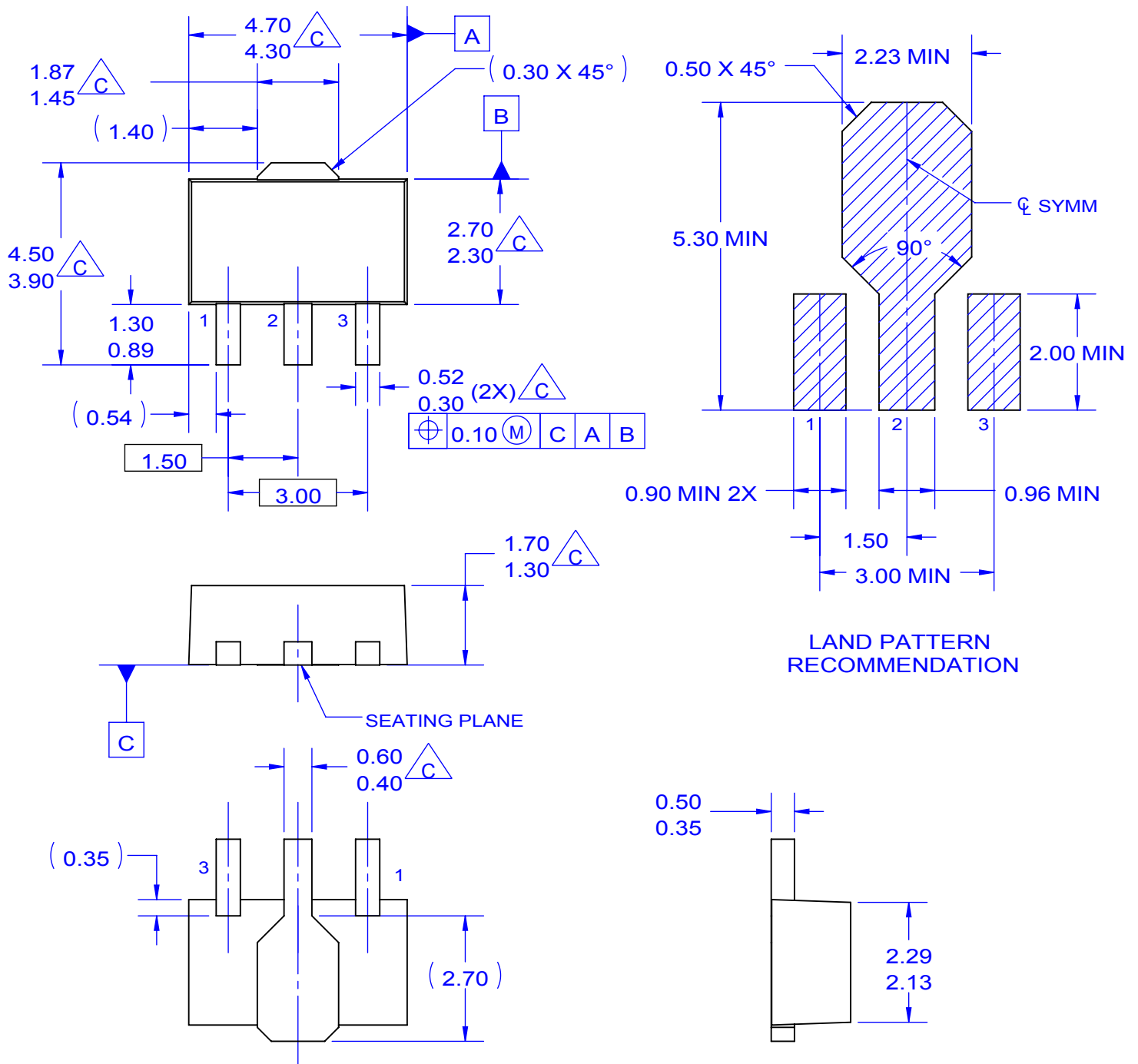

NOTES: UNLESS OTHERWISE SPECIFIED.

A. REFERENCE TO JEDEC TO-243 VARIATION AA.
 B. ALL DIMENSIONS ARE IN MILLIMETERS.

C DOES NOT COMPLY JEDEC STANDARD VALUE.
 D. DIMENSIONS ARE EXCLUSIVE OF BURRS,
 MOLD FLASH AND TIE BAR PROTRUSION.
 E. DIMENSION AND TOLERANCE AS PER ASME
 Y14.5-1994.

F. DRAWING FILE NAME: MA03CREV3



TRADEMARKS

The following includes registered and unregistered trademarks and service marks, owned by Fairchild Semiconductor and/or its global subsidiaries, and is not intended to be an exhaustive list of all such trademarks.

- | | | | |
|--------------------------|--|---------------------------------------|------------------|
| AccuPower™ | F-PFS™ | OPTOPLANAR® | SYSTEM GENERAL® |
| AttitudeEngine™ | FRFET® | Power Supply WebDesigner™ | TinyBoost® |
| Awinda® | Global Power Resource™ | PowerTrench® | TinyBuck® |
| AX-CAP®* | GreenBridge™ | PowerXS™ | TinyCalc™ |
| BitSiC™ | Green FPS™ | Programmable Active Droop™ | TinyLogic® |
| Build it Now™ | Green FPS™ e-Series™ | QFET® | TINYOPTO™ |
| CorePLUS™ | Gmax™ | QS™ | TinyPower™ |
| CorePOWER™ | GTO™ | Quiet Series™ | TinyPWM™ |
| CROSSVOL™ | IntelliMAX™ | RapidConfigure™ | TinyWire™ |
| CTL™ | ISOPLANAR™ | Saving our world, 1mW/W/kW at a time™ | TranSiC™ |
| Current Transfer Logic™ | Making Small Speakers Sound Louder and Better™ | SignalWise™ | TriFault Detect™ |
| DEUXPEED® | MegaBuck™ | SmartMax™ | TRUECURRENT®* |
| Dual Cool™ | MICROCOUPLER™ | SMART START™ | μSerDes™ |
| EcoSPARK® | MicroFET™ | Solutions for Your Success™ | UHC® |
| EfficientMax™ | MicroPak™ | SPM® | Ultra FRFET™ |
| ESBC™ | MicroPak2™ | STEALTH™ | UniFET™ |
| F [®] | MillerDrive™ | SuperFET® | Vcx™ |
| Fairchild® | MotionMax™ | SuperSOT™-3 | VisualMax™ |
| Fairchild Semiconductor® | MotionGrid® | SuperSOT™-6 | VoltagePlus™ |
| FACT Quiet Series™ | MTi® | SuperSOT™-8 | XST™ |
| FACT® | MTx® | SupreMOS® | Xsens™ |
| FastvCore™ | MVN® | SyncFET™ | 仙童® |
| FETBench™ | mWSaver® | Sync-Lock™ | |
| FPS™ | OptoHiT™ | | |
| | OPTOLOGIC® | | |

* Trademarks of System General Corporation, used under license by Fairchild Semiconductor.

DISCLAIMER

FAIRCHILD SEMICONDUCTOR RESERVES THE RIGHT TO MAKE CHANGES WITHOUT FURTHER NOTICE TO ANY PRODUCTS HEREIN TO IMPROVE RELIABILITY, FUNCTION, OR DESIGN. TO OBTAIN THE LATEST, MOST UP-TO-DATE DATASHEET AND PRODUCT INFORMATION, VISIT OUR WEBSITE AT [HTTP://WWW.FAIRCHILDSEMI.COM](http://www.fairchildsemi.com). FAIRCHILD DOES NOT ASSUME ANY LIABILITY ARISING OUT OF THE APPLICATION OR USE OF ANY PRODUCT OR CIRCUIT DESCRIBED HEREIN; NEITHER DOES IT CONVEY ANY LICENSE UNDER ITS PATENT RIGHTS, NOR THE RIGHTS OF OTHERS. THESE SPECIFICATIONS DO NOT EXPAND THE TERMS OF FAIRCHILD'S WORLDWIDE TERMS AND CONDITIONS, SPECIFICALLY THE WARRANTY THEREIN, WHICH COVERS THESE PRODUCTS.

AUTHORIZED USE

Unless otherwise specified in this data sheet, this product is a standard commercial product and is not intended for use in applications that require extraordinary levels of quality and reliability. This product may not be used in the following applications, unless specifically approved in writing by a Fairchild officer: (1) automotive or other transportation, (2) military/aerospace, (3) any safety critical application – including life critical medical equipment – where the failure of the Fairchild product reasonably would be expected to result in personal injury, death or property damage. Customer's use of this product is subject to agreement of this Authorized Use policy. In the event of an unauthorized use of Fairchild's product, Fairchild accepts no liability in the event of product failure. In other respects, this product shall be subject to Fairchild's Worldwide Terms and Conditions of Sale, unless a separate agreement has been signed by both Parties.

ANTI-COUNTERFEITING POLICY

Fairchild Semiconductor Corporation's Anti-Counterfeiting Policy. Fairchild's Anti-Counterfeiting Policy is also stated on our external website, www.fairchildsemi.com, under Terms of Use

Counterfeiting of semiconductor parts is a growing problem in the industry. All manufacturers of semiconductor products are experiencing counterfeiting of their parts. Customers who inadvertently purchase counterfeit parts experience many problems such as loss of brand reputation, substandard performance, failed applications, and increased cost of production and manufacturing delays. Fairchild is taking strong measures to protect ourselves and our customers from the proliferation of counterfeit parts. Fairchild strongly encourages customers to purchase Fairchild parts either directly from Fairchild or from Authorized Fairchild Distributors who are listed by country on our web page cited above. Products customers buy either from Fairchild directly or from Authorized Fairchild Distributors are genuine parts, have full traceability, meet Fairchild's quality standards for handling and storage and provide access to Fairchild's full range of up-to-date technical and product information. Fairchild and our Authorized Distributors will stand behind all warranties and will appropriately address any warranty issues that may arise. Fairchild will not provide any warranty coverage or other assistance for parts bought from Unauthorized Sources. Fairchild is committed to combat this global problem and encourage our customers to do their part in stopping this practice by buying direct or from authorized distributors.

PRODUCT STATUS DEFINITIONS

Definition of Terms

Datasheet Identification	Product Status	Definition
Advance Information	Formative / In Design	Datasheet contains the design specifications for product development. Specifications may change in any manner without notice.
Preliminary	First Production	Datasheet contains preliminary data; supplementary data will be published at a later date. Fairchild Semiconductor reserves the right to make changes at any time without notice to improve design.
No Identification Needed	Full Production	Datasheet contains final specifications. Fairchild Semiconductor reserves the right to make changes at any time without notice to improve the design.
Obsolete	Not In Production	Datasheet contains specifications on a product that is discontinued by Fairchild Semiconductor. The datasheet is for reference information only.