

Surface Mount Ceramic Capacitor Products

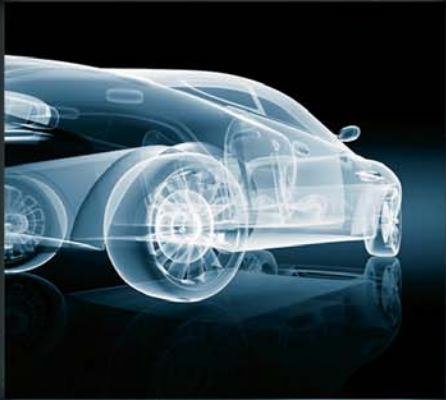

Total Customer Satisfaction



A KYOCERA GROUP COMPANY

Version 16.7

Ceramic Chip Capacitors



Table of Contents

How to Order - AVX Part Number Explanation	2-3	Automotive MLCC	
C0G (NP0) Dielectric		General Specifications	51-52
General Specifications	4	Capacitance Range.....	53-55
Specifications and Test Methods.....	5	APS for COTS+ Applications	
Capacitance Range	6-7	General Specifications	56
U Dielectric		Capacitance Range.....	57-59
RF/Microwave C0G (NP0) Capacitors (RoHS)		MLCC with FLEXITERM®	
General Information and Capacitance Range	8-10	General Description.....	60
RF/Microwave C0G (NP0) Capacitors (Sn/Pb)		Specifications and Test Methods.....	61-62
General Information and Capacitance Range	11-12	Capacitance Range.....	63-64
RF/Microwave C0G (NP0) Capacitors (RoHS)		FLEXISAFE MLC Chips	
AEC-Q200 Qualified	13-14	General Specifications and Capacitance Range	65
Designer Kits	15	Capacitor Array	
X8R/X8L Dielectric		Capacitor Array (IPC)	66-69
General Specifications	16-17	Automotive Capacitor Array (IPC).....	70
Specifications and Test Methods.....	18	Part and Pad Layout Dimensions	71
X7R Dielectric		Low Inductance Capacitors	
General Specifications	19	Introduction	72-73
Specifications and Test Methods.....	20	LICC (Low Inductance Chip Capacitors)	74-77
Capacitance Range.....	21-22	IDC (InterDigitated Capacitors)	78-81
X7S Dielectric		LGA (Low Inductance Capacitors)	82-84
General Specifications	23	LICA (Low Inductance Decoupling Capacitor Arrays)	85-86
Specifications and Test Methods.....	24	High Temperature MLCCs	
Capacitance Range.....	25	AT Series 200°C & 250°C Rated MLCCs	87-92
X5R Dielectric		High Voltage MLC Chips	
General Specifications	26	600V to 5000V Applications	93-97
Specifications and Test Methods.....	27	Tin/Lead Termination “B” - 600V to 5000V Applications ...	98-99
Capacitance Range.....	28-29	FLEXITERM® - 600V to 5000V Applications.....	100-104
Y5V Dielectric		600V to 3000V Automotive Applications – AEC-Q200...	105-106
General Specifications	30	MIL-PRF-55681/Chips	
Specifications and Test Methods.....	31	CDR01 thru CDR06	107-108
Capacitance Range.....	32	CDR31 thru CDR35	109-112
MLCC Gold Termination (AU Series)		MLCC Medical	
General Specifications	33	MQ Series	113-121
Capacitance Range.....	34-39	Packaging of Chip Components	122
MLCC Tin/Lead Termination (LD Series)		Embossed Carrier Configuration - 8 & 12mm Tape ...	123
General Specifications	40	Paper Carrier Configuration - 8 & 12mm Tape	124
Capacitance Range.....	41-46	Basic Capacitor Formulas	125
MLCC Low Profile		General Description	126-130
General Specifications / Capacitance Range.....	47	Surface Mounting Guide	131-135
UltraThin Ceramic Capacitors			
General Specifications	48-50		



How to Order

Part Number Explanation

Commercial Surface Mount Chips

EXAMPLE: 08055A101JAT2A

0805	5	A	101	J*	A	T	2	A**
Size (L" x W")	Voltage	Dielectric	Capacitance	Tolerance	Failure Rate	Terminations	Packaging Available	Special Code
0101*	4 = 4V	A = NP0(C0G)	2 Sig. Fig + No. of Zeros	B = ±.10 pF	A = N/A	T = Plated Ni and Sn	2 = 7" Reel	A = Std
0201	6 = 6.3V	C = X7R	Examples:	C = ±.25 pF	4 = Automotive	7 = Gold Plated	4 = 13" Reel	K = 30K (0603 2mm pitch)
0402	Z = 10V	D = X5R	100 = 10 pF	D = ±.50 pF (≥ 10 pF)		U = Conductive	U = 4mm TR (01005)	22K (0805/1206 <0.030" / 0.76mm)
0603	Y = 16V	F = X8R	101 = 100 pF	F = ±1% (≥ 10 pF)		Expoxy for Hybrid		H = 18K (0603/0805/1206 <0.037" / 0.94mm)
0805	D = 35V	U = U Series	102 = 1000 pF	G = ±2% (≥ 10 pF)		Applications		J = 15K (0805/1206 <0.050" / 1.27mm)
1206	5 = 50V	W = X6S	223 = 22000 pF	J = ±5%		Z = FLEXITERM®		1 = 12K (0805/1206 <0.055" / 1.4mm)
1210	1 = 100V	Z = X7S	224 = 220000 pF	K = ±10%		*X = FLEXITERM® with 5% min lead (X7R & X8R only)		**Non std options upon approval from the factory
1812	2 = 200V		105 = 1µF	M = ±20%				
1825	7 = 500V		106 = 10µF	Z = +80%, -20%				
2220			107 = 100µF	P = +100%, -0%				
2225			For values below 10 pF, use "R" in place of Decimal point, e.g., 9.1 pF = 9R1.					
	Contact Factory for Special Voltages					Contact Factory For 1 = Pd/Ag Term		
	F = 63V	9 = 300V						
	* = 75V	X = 350V						
	E = 150V	8 = 400V						
	V = 250V							

*EIA 01005

* B, C & D tolerance for ≤10 pF values.

Standard Tape and Reel material (Paper/Embossed) depends upon chip size and thickness.

See individual part tables for tape material type for each capacitance value.

NOTE: Contact factory for availability of Termination and Tolerance Options for Specific Part Numbers.
For Tin/Lead Terminations, please refer to LD Series

High Voltage MLC Chips

EXAMPLE: 1808AA271KA11A

1808	A	A	271	K	A	T	2	A
AVX Style	Voltage	Temperature Coefficient	Capacitance Code	Capacitance Tolerance	Failure Rate	Termination	Packaging/ Marking	Special Code
0805	C = 600V/630V	A = C0G	(2 significant digits + no. of zeros)	C0G: J = ±5%	A=Not Applicable	1 = Pd/Ag	2 = 7" Reel	A = Standard
1206	A = 1000V	C = X7R	Examples:	K = ±10%		T = Plated Ni and Sn	4 = 13" Reel	
1210	S = 1500V		10 pF = 100	M = ±20%		B = 5% Min Pb		
1808	G = 2000V		100 pF = 101	X7R: K = ±10%		Z = FLEXITERM®		
1812	W = 2500V		1,000 pF = 102	M = ±20%		*X = FLEXITERM® with 5% min lead (X7R only)		
1825	H = 3000V		22,000 pF = 223	Z = +80%, -20%				
2220	J = 4000V		220,000 pF = 224					
2225	K = 5000V		1 µF = 105					
3640								

NOTE: Contact factory for availability of Termination and Tolerance Options for Specific Part Numbers.
For Tin/Lead Terminations, please refer to LD Series

*** Not RoHS Compliant**



For RoHS compliant products,
please select correct termination style.

How to Order

Part Number Explanation



Capacitor Array

EXAMPLE: W2A43C103MAT2A

W	2	A	4	3	C	103	M	A	T	2A
Style W = RoHS L = SnPb	Case Size 1 = 0405 2 = 0508 3 = 0612	Array	Number of Caps	Voltage Z = 10V Y = 16V 3 = 25V 5 = 50V 1 = 100V	Dielectric A = NP0 C = X7R D = X5R	Capacitance Code (In pF) 2 Sig Digits + Number of Zeros	Capacitance Tolerance J = ±5% K = ±10% M = ±20%	Failure Rate A = Commercial 4 = Automotive	Termination Code T = Plated Ni and Sn Z = FLEXITERM® *B = 5% min lead *X = FLEXITERM® with 5% min lead	Packaging & Quantity Code 2A = 7" Reel (4000) 4A = 13" Reel (10000) 2F = 7" Reel (1000)

NOTE: Contact factory for availability of Termination and Tolerance Options for Specific Part Numbers.

Low Inductance Capacitors (LICC)

EXAMPLE: 0612ZD105MAT2A

0612	Z	D	105	M	A	T	2	A
Size 0306 0508 0612 *LD16 *LD17 *LD18	Voltage 6 = 6.3V Z = 10V Y = 16V 3 = 25V 5 = 50V	Dielectric C = X7R D = X5R	Capacitance Code (In pF) 2 Sig. Digits + Number of Zeros	Capacitance Tolerance K = ±10% M = ±20%	Failure Rate A = N/A	Terminations T = Plated Ni and Sn *B = 5% min lead	Packaging Available 2 = 7" Reel 4 = 13" Reel	Thickness See Page 77 for Codes

NOTE: Contact factory for availability of Termination and Tolerance Options for Specific Part Numbers.

Interdigitated Capacitors (IDC)

EXAMPLE: W3L16D225MAT3A

W	3	L	1	6	D	225	M	A	T	3	A
Style W = RoHS L = SnPb	Case Size 2 = 0508 3 = 0612	Low Inductance ESL = 50pH ESL = 60pH	Number of Terminals 1 = 8 Terminals	Voltage 4 = 4V 6 = 6.3V Z = 10V Y = 16V	Dielectric C = X7R D = X5R	Capacitance Code (In pF) 2 Sig. Digits + Number of Zeros	Capacitance Tolerance M = ±20%	Failure Rate A = N/A	Termination T = Plated Ni and Sn *B = 5% min Lead	Packaging Available 1=7" Reel 3=13" Reel	Thickness Max. Thickness mm (in.) A=0.95 (0.037) S=0.55 (0.022)

NOTE: Contact factory for availability of Termination and Tolerance Options for Specific Part Numbers.

Low Inductance Decoupling Capacitor Arrays (LICA)

EXAMPLE: LICA3T183M3FC4AA

LICA	3	T	102	M	3	F	C	4	A	A
Style & Size 5V = 9 10V = Z 25V = 3	Voltage 5V = 9 10V = Z 25V = 3	Dielectric D = X5R T = T55T S = High K T55T	Cap/Section (EIA Code) 102 = 1000 pF 103 = 10 nF 104 = 100 nF	Capacitance Tolerance M = ±20% P = GMV	Height Code 6 = 0.500mm 3 = 0.650mm 1 = 0.875mm 5 = 1.100mm 7 = 1.600mm	Termination *F = C4 Solder Balls- 97Pb/3Sn H = C4 Solder Balls-Low ESR P = Cr-Cu-Au N = Cr-Ni-Au X = None	Reel Packaging M = 7" Reel R = 13" Reel 6 = 2"x2" Waffle Pack 8 = 2"x2" Black Waffle Pack 7 = 2"x2" Waffle Pack w/ termination facing up A = 2"x2" Black Waffle Pack w/ termination facing up C = 4"x4" Waffle Pack w/ clear lid	# of Caps/Part 1 = one 2 = two 4 = four	Inspection Code A = Standard B = Established Reliability Testing	Code Face A = Bar B = No Bar C = Dot, S55S Dielectrics D = Triangle

* Not RoHS Compliant



NOTE: Contact factory for availability of Termination and Tolerance Options for Specific Part Numbers.

COG (NP0) Dielectric

General Specifications

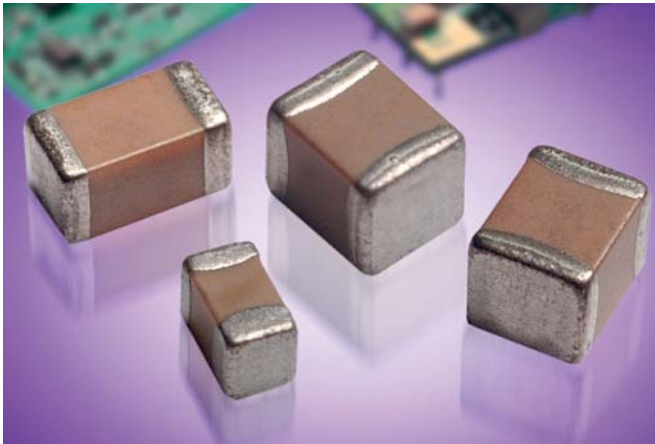

COG (NP0) is the most popular formulation of the "temperature-compensating," EIA Class I ceramic materials. Modern COG (NP0) formulations contain neodymium, samarium and other rare earth oxides.

COG (NP0) ceramics offer one of the most stable capacitor dielectrics available. Capacitance change with temperature is $0 \pm 30 \text{ ppm}/^\circ\text{C}$ which is less than $\pm 0.3\% \Delta C$ from -55°C to $+125^\circ\text{C}$. Capacitance drift or hysteresis for COG (NP0) ceramics is negligible at less than $\pm 0.05\%$ versus up to $\pm 2\%$ for films. Typical capacitance change with life is less than $\pm 0.1\%$ for COG (NP0), one-fifth that shown by most other dielectrics. COG (NP0) formulations show no aging characteristics.



PART NUMBER (see page 2 for complete part number explanation)

0805

Size
(L" x W")

5

Voltage
6.3V = 6
10V = Z
16V = Y
25V = 3
50V = 5
100V = 1
200V = 2
500V = 7

A

Dielectric
COG (NP0) = A

101

Capacitance Code (In pF)
2 Sig. Digits +
Number of
Zeros

J

Capacitance Tolerance
B = $\pm 10 \text{ pF}$ ($< 10 \text{ pF}$)
C = $\pm 25 \text{ pF}$ ($< 10 \text{ pF}$)
D = $\pm 50 \text{ pF}$ ($< 10 \text{ pF}$)
F = $\pm 1\%$ ($\geq 10 \text{ pF}$)
G = $\pm 2\%$ ($\geq 10 \text{ pF}$)
J = $\pm 5\%$
K = $\pm 10\%$

A

Failure Rate
A = Not
Applicable

T

Terminations
T = Plated Ni
and Sn

2

Packaging
2 = 7" Reel
4 = 13" Reel
U = 4mm TR
(01005)

A

Special Code
A = Std.
Product

Contact Factory For
1 = Pd/Ag Term
7 = Gold Plated
NOT RoHS COMPLIANT

Contact Factory For Multiples

NOTE: Contact factory for availability of Termination and Tolerance Options for Specific Part Numbers. Contact factory for non-specified capacitance values.

Temperature Coefficient

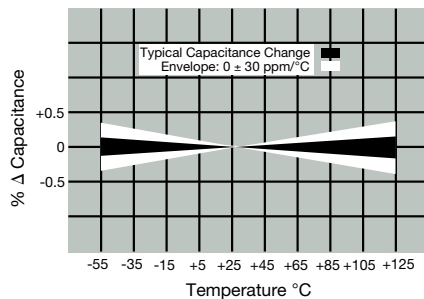

Δ Capacitance vs. Frequency

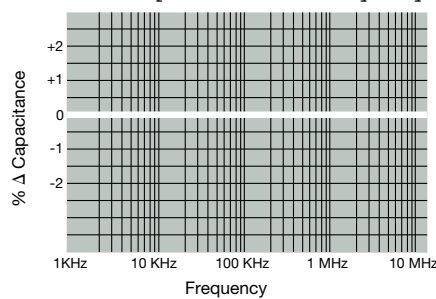

Insulation Resistance vs Temperature

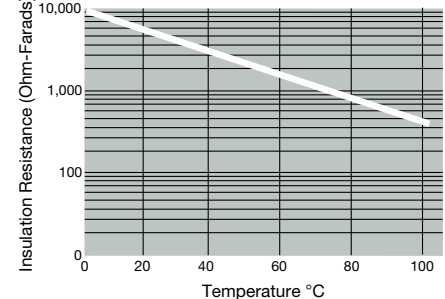

Variation of Impedance with Cap Value
Impedance vs. Frequency
0805 - COG (NP0)
10 pF vs. 100 pF vs. 1000 pF

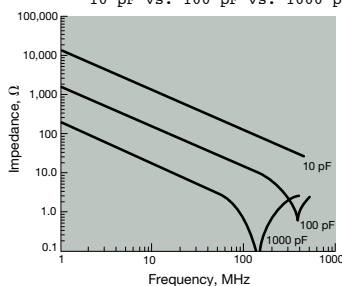

Variation of Impedance with Chip Size
Impedance vs. Frequency
1000 pF - COG (NP0)

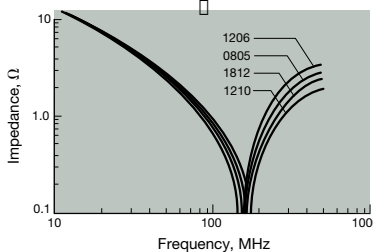

Variation of Impedance with Ceramic Formu
Impedance vs. Frequency
1000 pF - COG (NP0) vs X7R
0805

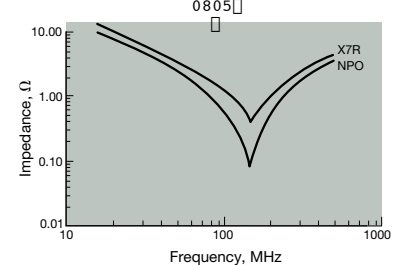

COG (NP0) Dielectric

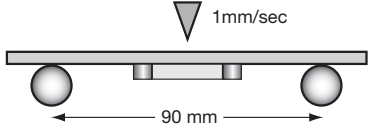

Specifications and Test Methods

Parameter/Test		NP0 Specification Limits	Measuring Conditions	
Operating Temperature Range		-55°C to +125°C	Temperature Cycle Chamber	
Capacitance		Within specified tolerance	Freq.: 1.0 MHz ± 10% for cap ≤ 1000 pF 1.0 kHz ± 10% for cap > 1000 pF Voltage: 1.0Vrms ± .2V	
Q		<30 pF: Q ≥ 400+20 x Cap Value ≥30 pF: Q ≥ 1000	Charge device with rated voltage for 60 ± 5 secs @ room temp/humidity	
Insulation Resistance		100,000MΩ or 1000MΩ - μF, whichever is less	Charge device with 300% of rated voltage for 1-5 seconds, w/charge and discharge current limited to 50 mA (max) Note: Charge device with 150% of rated voltage for 500V devices.	
Dielectric Strength		No breakdown or visual defects	Deflection: 2mm Test Time: 30 seconds 1mm/sec 	
Resistance to Flexure Stresses	Appearance	No defects		
	Capacitance Variation	±5% or ±.5 pF, whichever is greater		
	Q	Meets Initial Values (As Above)		
	Insulation Resistance	≥ Initial Value x 0.3		
Solderability		≥ 95% of each terminal should be covered with fresh solder	Dip device in eutectic solder at 230 ± 5°C for 5.0 ± 0.5 seconds	
Resistance to Solder Heat	Appearance	No defects, <25% leaching of either end terminal	Dip device in eutectic solder at 260°C for 60 seconds. Store at room temperature for 24 ± 2 hours before measuring electrical properties.	
	Capacitance Variation	≤ ±2.5% or ±.25 pF, whichever is greater		
	Q	Meets Initial Values (As Above)		
	Insulation Resistance	Meets Initial Values (As Above)		
Thermal Shock	Dielectric Strength	Meets Initial Values (As Above)	Repeat for 5 cycles and measure after 24 hours at room temperature	
	Appearance	No visual defects	Step 1: -55°C ± 2°	30 ± 3 minutes
	Capacitance Variation	≤ ±2.5% or ±.25 pF, whichever is greater	Step 2: Room Temp	≤ 3 minutes
	Q	Meets Initial Values (As Above)	Step 3: +125°C ± 2°	30 ± 3 minutes
	Insulation Resistance	Meets Initial Values (As Above)	Step 4: Room Temp	≤ 3 minutes
Load Life	Dielectric Strength	Meets Initial Values (As Above)	Charge device with twice rated voltage in test chamber set at 125°C ± 2°C for 1000 hours (+48, -0).	
	Appearance	No visual defects	Remove from test chamber and stabilize at room temperature for 24 hours before measuring.	
	Capacitance Variation	≤ ±3.0% or ± .3 pF, whichever is greater		
	Q (C=Nominal Cap)	≥ 30 pF: Q ≥ 350 ≥10 pF, <30 pF: Q ≥ 275 +5C/2 <10 pF: Q ≥ 200 +10C		
	Insulation Resistance	≥ Initial Value x 0.3 (See Above)		
Load Humidity	Dielectric Strength	Meets Initial Values (As Above)	Store in a test chamber set at 85°C ± 2°C/ 85% ± 5% relative humidity for 1000 hours (+48, -0) with rated voltage applied.	
	Appearance	No visual defects	Remove from chamber and stabilize at room temperature for 24 ± 2 hours before measuring.	
	Capacitance Variation	≤ ±5.0% or ± .5 pF, whichever is greater		
	Q	≥ 30 pF: Q ≥ 350 ≥10 pF, <30 pF: Q ≥ 275 +5C/2 <10 pF: Q ≥ 200 +10C		
Insulation Resistance	Insulation Resistance	≥ Initial Value x 0.3 (See Above)		
	Dielectric Strength	Meets Initial Values (As Above)		

RF/Microwave COG (NP0) Capacitors (RoHS)

Ultra Low ESR, "U" Series, COG (NP0) Chip Capacitors

GENERAL INFORMATION

"U" Series capacitors are COG (NP0) chip capacitors specially designed for "Ultra" low ESR for applications in the communications market. Max ESR and effective capacitance

are met on each value producing lot to lot uniformity. Sizes available are EIA chip sizes 0402, 0603, 0805, and 1210.

DIMENSIONS: inches (millimeters)

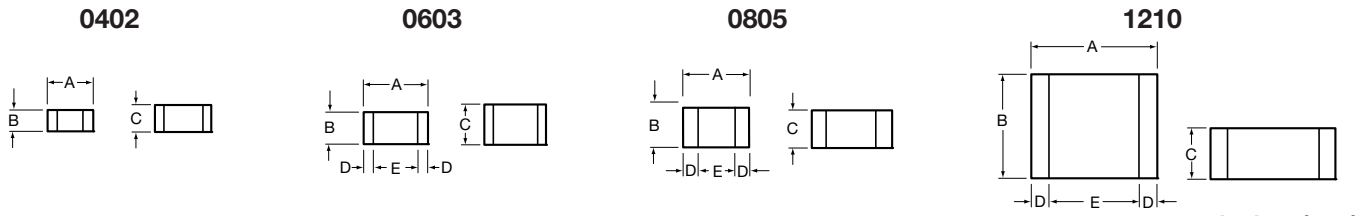

Size	A	B	C	D	E
0402	0.039±0.004 (1.00±0.1)	0.020±0.004 (0.50±0.1)	0.022 (0.55mm) max	N/A	N/A
0603	0.060±0.010 (1.52±0.25)	0.030±0.010 (0.76±0.25)	0.036 (0.91mm) max	0.010±0.005 (0.25±0.13)	0.030 (0.76) min
0805	0.079±0.008 (2.01±0.2)	0.049±0.008 (1.25±0.2)	0.040±0.005 (1.02±0.127)	0.020±0.010 (0.51±0.255)	0.020 (0.51) min
1210	0.126±0.008 (3.2±0.2)	0.098±0.008 (2.49±0.2)	0.050±0.005 (1.27±0.127)	0.025±0.015 (0.635±0.381)	0.040 (1.02) min

HOW TO ORDER

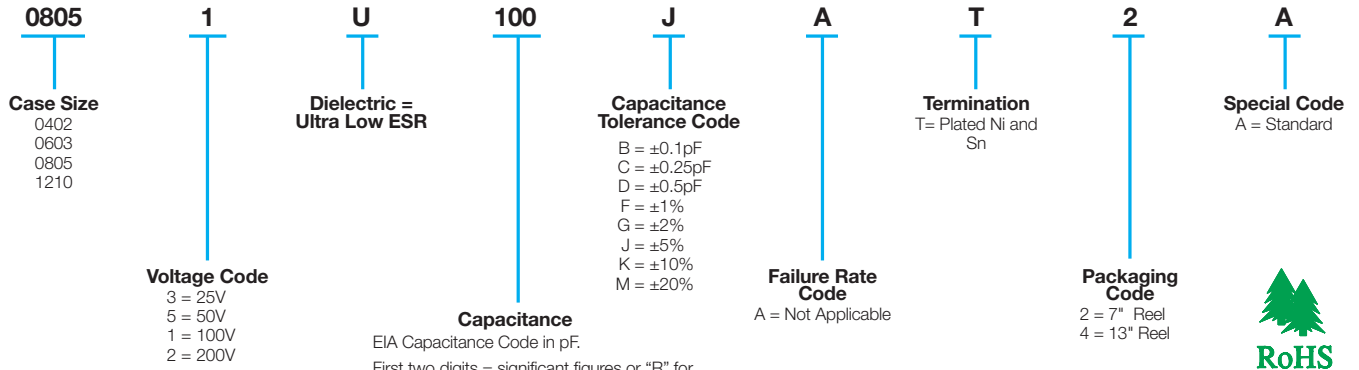

NOTE: Contact factory for availability of Termination and Tolerance Options for Specific Part Numbers.

ELECTRICAL CHARACTERISTICS

Capacitance Values and Tolerances:

- Size 0402 - 0.2 pF to 30 pF @ 1 MHz
- Size 0603 - 1.0 pF to 100 pF @ 1 MHz
- Size 0805 - 1.6 pF to 160 pF @ 1 MHz
- Size 1210 - 2.4 pF to 1000 pF @ 1 MHz

Temperature Coefficient of Capacitance (TC):

0±30 ppm/°C (-55° to +125°C)

Insulation Resistance (IR):

- 10¹² Ω min. @ 25°C and rated WVDC
- 10¹¹ Ω min. @ 125°C and rated WVDC

Working Voltage (WVDC):

- Size Working Voltage
- 0402 - 50, 25 WVDC
- 0603 - 200, 100, 50 WVDC
- 0805 - 200, 100 WVDC
- 1210 - 200, 100 WVDC

Dielectric Working Voltage (DWV):

250% of rated WVDC

Equivalent Series Resistance Typical (ESR):

- 0402 - See Performance Curve, page 9
- 0603 - See Performance Curve, page 9
- 0805 - See Performance Curve, page 9
- 1210 - See Performance Curve, page 9

Marking: Laser marking EIA J marking standard

(except 0603) (capacitance code and tolerance upon request).

MILITARY SPECIFICATIONS

Meets or exceeds the requirements of MIL-C-55681

RF/Microwave COG (NP0) Capacitors (RoHS)

Ultra Low ESR, "U" Series, COG (NP0) Chip Capacitors

CAPACITANCE RANGE

Cap (pF)	Available Tolerance	Size				Cap (pF)	Available Tolerance	Size				Cap (pF)	Available Tolerance	Size			
		0402	0603	0805	1210			0402	0603	0805	1210			0402	0603	0805	1210
0.2	B,C	50V	N/A	N/A	N/A	1.0	B,C,D	50V	200V	200V	200V	100	F,G,J,K,M	N/A	100V	200V	200V
0.3						1.1						110			50V	200V	200V
0.4	B,C					1.2						120			50V	200V	200V
0.5	B,C					1.3						130			N/A	200V	200V
0.6	B,C,D					1.4						140				100V	200V
0.7						1.5						150				100V	200V
0.8	B,C,D					1.6						160				100V	200V
0.9						1.7						180				N/A	200V
						1.8						200					200V
						1.9						220					200V
						2.0						220					200V
						2.1						270					200V
						2.2						300					200V
						2.4						330					200V
						2.7						360					200V
						3.0						390					200V
						3.3						430					200V
						3.6						470					200V
						3.9						510					200V
						4.3						560					200V
						4.7						620					200V
						5.1						680					200V
						5.6						750					200V
						6.2	B,C,D					820					200V
						6.8	B,C,J,K,M					910					200V
												1000	F,G,J,K,M				200V



ULTRA LOW ESR, "U" SERIES

TYPICAL ESR vs. FREQUENCY
0402 "U" SERIES

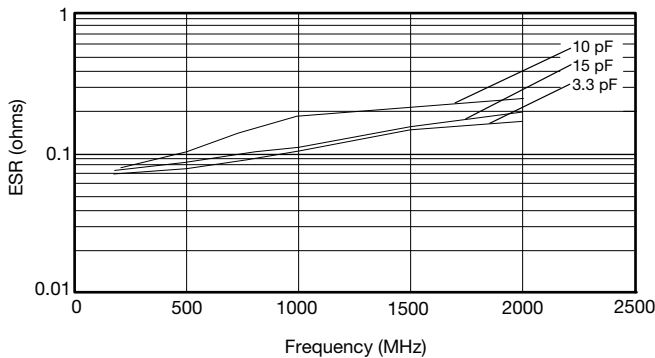

TYPICAL ESR vs. FREQUENCY
0603 "U" SERIES

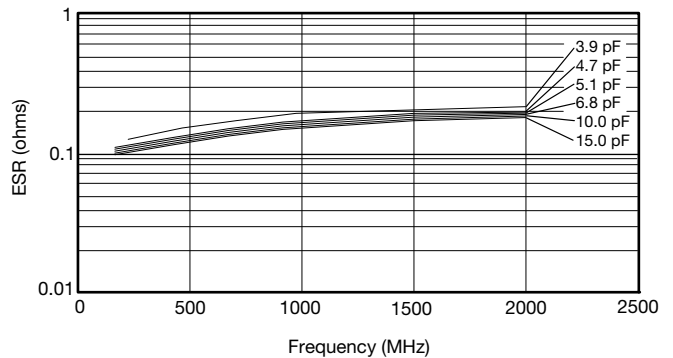

TYPICAL ESR vs. FREQUENCY
0805 "U" SERIES

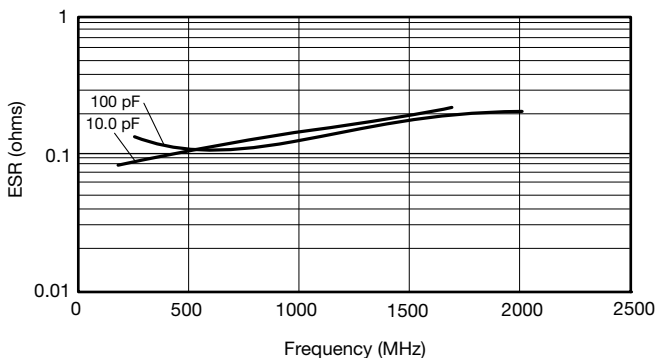

TYPICAL ESR vs. FREQUENCY
1210 "U" SERIES

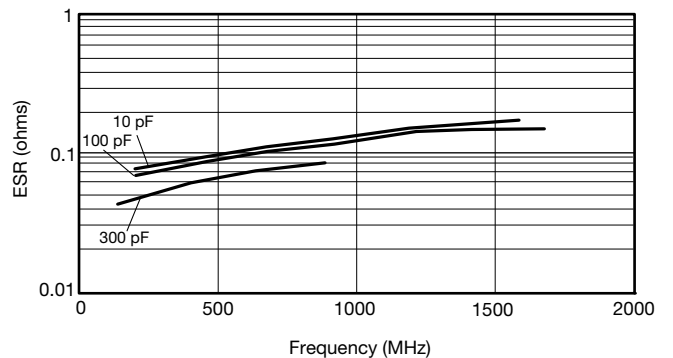

ESR Measured on the Boonton 34A

RF/Microwave C0G (NP0) Capacitors

Ultra Low ESR, "U" Series, C0G (NP0) Chip Capacitors

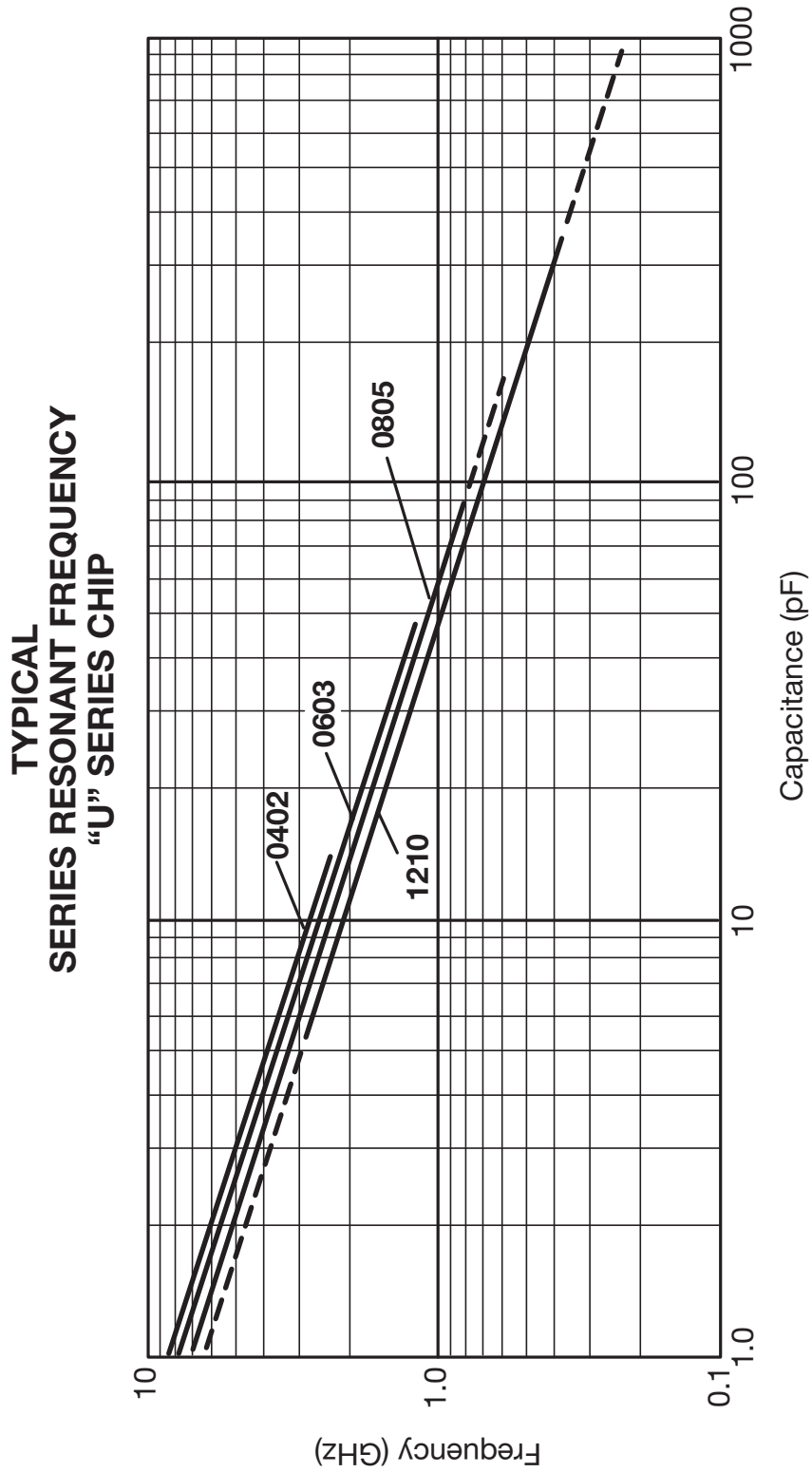

RF/Microwave C0G (NP0) Capacitors (Sn/Pb)

Ultra Low ESR, "U" Series, C0G (NP0) Chip Capacitors

GENERAL INFORMATION

"U" Series capacitors are C0G (NP0) chip capacitors specially designed for "Ultra" low ESR for applications in the communications market. Max ESR and effective capacitance

are met on each value producing lot to lot uniformity. Sizes available are EIA chip sizes 0402, 0603, 0805, and 1210.

DIMENSIONS: inches (millimeters)

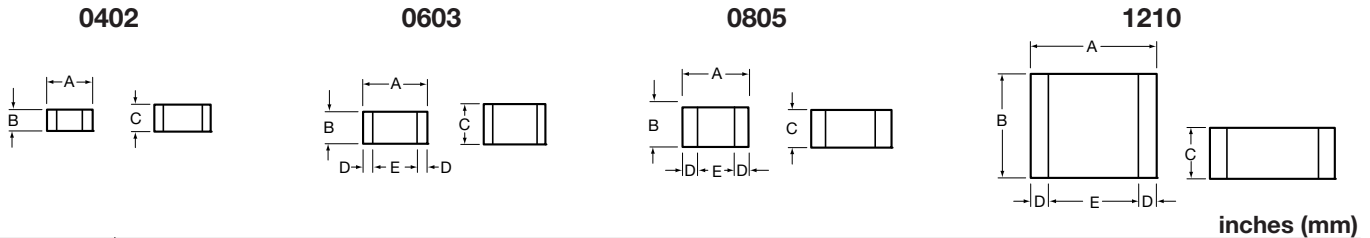

Size	A	B	C	D	E
0402	0.039±0.004 (1.00±0.1)	0.020±0.004 (0.50±0.1)	0.022 (0.55mm) max	N/A	N/A
0603	0.060±0.010 (1.52±0.25)	0.030±0.010 (0.76±0.25)	0.036 (0.91mm) max	0.010±0.005 (0.25±0.13)	0.030 (0.76) min
0805	0.079±0.008 (2.01±0.2)	0.049±0.008 (1.25±0.2)	0.040±0.005 (1.02±0.127)	0.020±0.010 (0.51±0.254)	0.020 (0.51) min
1210	0.126±0.008 (3.2±0.2)	0.098±0.008 (2.49±0.2)	0.050±0.005 (1.27±0.127)	0.025±0.015 (0.635±0.381)	0.040 (1.02) min

HOW TO ORDER

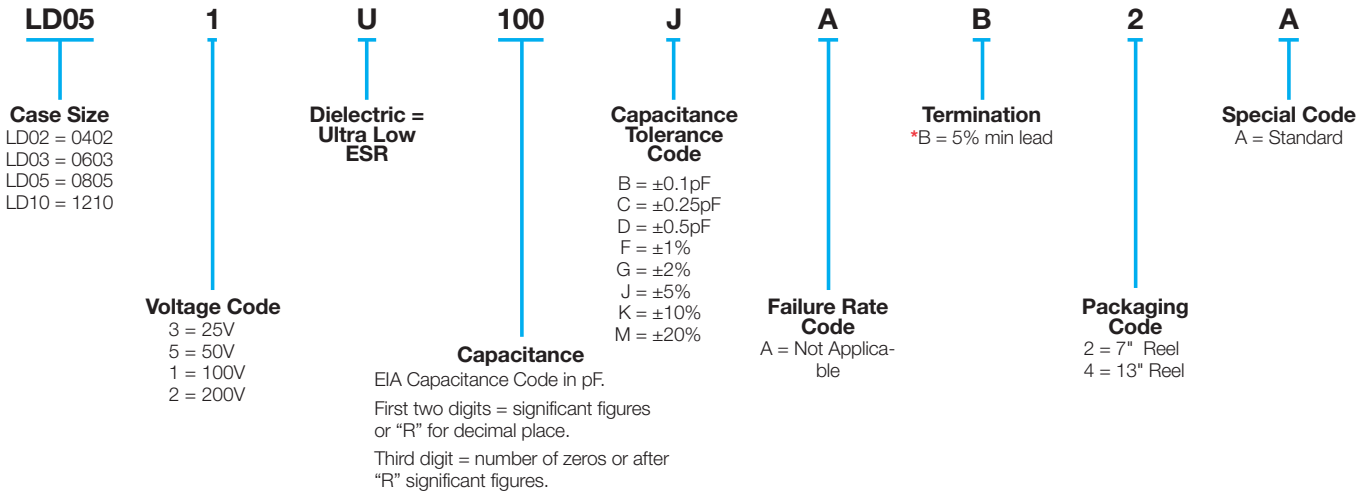

ELECTRICAL CHARACTERISTICS

Capacitance Values and Tolerances:

- Size 0402 - 0.2 pF to 22 pF @ 1 MHz
- Size 0603 - 1.0 pF to 100 pF @ 1 MHz
- Size 0805 - 1.6 pF to 160 pF @ 1 MHz
- Size 1210 - 2.4 pF to 1000 pF @ 1 MHz

Temperature Coefficient of Capacitance (TC):

0±30 ppm/°C (-55° to +125°C)

Insulation Resistance (IR):

- 10¹² Ω min. @ 25°C and rated WVDC
- 10¹¹ Ω min. @ 125°C and rated WVDC

Working Voltage (WVDC):

- Size Working Voltage
- 0402 - 50, 25 WVDC
- 0603 - 200, 100, 50 WVDC
- 0805 - 200, 100 WVDC
- 1210 - 200, 100 WVDC

Dielectric Working Voltage (DWV):

250% of rated WVDC

Equivalent Series Resistance Typical (ESR):

- 0402 - See Performance Curve, page 12
- 0603 - See Performance Curve, page 12
- 0805 - See Performance Curve, page 12
- 1210 - See Performance Curve, page 12

Marking: Laser marking EIA J marking standard (except 0603) (capacitance code and tolerance upon request).

MILITARY SPECIFICATIONS

Meets or exceeds the requirements of MIL-C-55681

*** Not RoHS Compliant**

RF/Microwave Automotive C0G (NP0) Capacitors (RoHS), AEC Q200 Qualified

Ultra Low ESR, "U" Series, C0G (NP0) Chip Capacitors

GENERAL INFORMATION

Automotive "U" Series capacitors are C0G (NP0) chip capacitors specially designed for "Ultra" low ESR for applications in the automotive market. Max ESR and effective capacitance are met on each value producing lot to lot uniformity. Sizes available are EIA chip sizes 0402 and 0603.

DIMENSIONS: mm (inches)

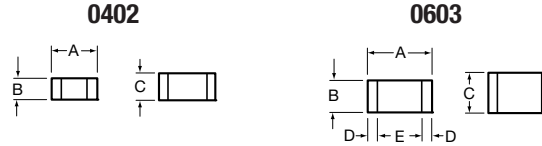

Size	A	B	C	D	E
0402	1.00±0.1 (0.039±0.004)	0.50±0.1 (0.020±0.004)	0.60 max (0.024)	N/A	N/A
0603	1.52±0.25 (0.060±0.010)	0.76±0.25 (0.030±0.010)	0.91 max (0.036)	0.25±0.13 (0.010±0.005)	0.76 min (0.030)

HOW TO ORDER

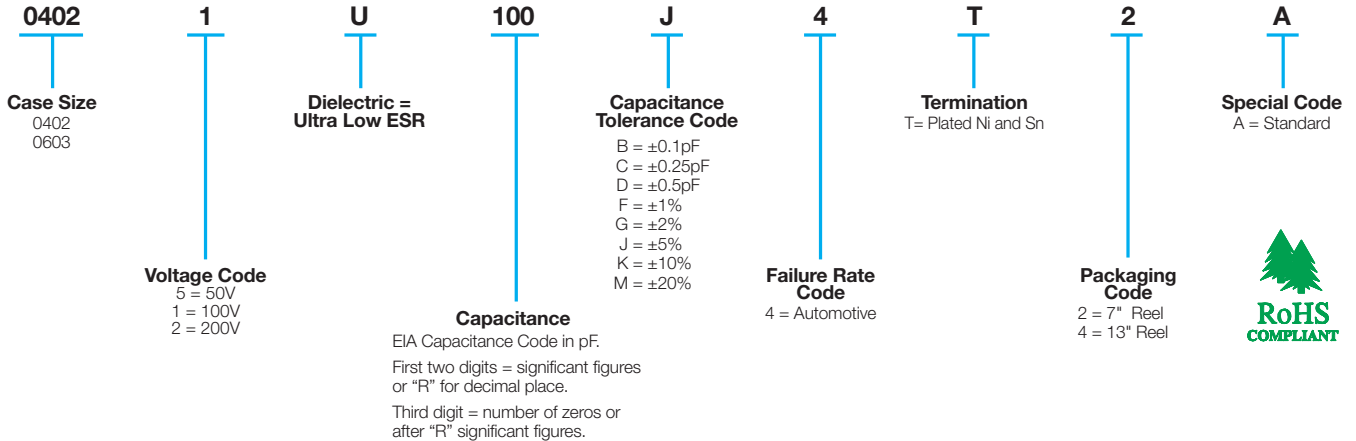

ELECTRICAL CHARACTERISTICS

Capacitance Values and Tolerances:

Size 0402 - 0.2 pF to 22 pF @ 1 MHz
Size 0603 - 1.0 pF to 100 pF @ 1 MHz

Temperature Coefficient of Capacitance (TC):

0±30 ppm/°C (-55° to +125°C)

Insulation Resistance (IR):

10¹² Ω min. @ 25°C and rated WVDC
10¹¹ Ω min. @ 125°C and rated WVDC

Working Voltage (WVDC):

Size Working Voltage
0402 - 50, 25 WVDC
0603 - 200, 100, 50 WVDC

Dielectric Working Voltage (DWV):

250% of rated WVDC

Equivalent Series Resistance Typical (ESR):

0402 - See Performance Curve
0603 - See Performance Curve

Automotive Specifications

Meets or exceeds the requirements of AEC Q200

RF/Microwave Automotive C0G (NP0) Capacitors (RoHS), AEC Q200 Qualified

Ultra Low ESR, "U" Series, C0G (NP0) Chip Capacitors

CAPACITANCE RANGE

Cap (pF)	Available Tolerance	Size	
		0402	0603
0.2	B,C	50V	N/A
0.3	↓ B,C	↓	↓
0.4			
0.5	B,C	↓	↓
0.6	B,C,D		
0.7	↓ B,C,D	↓	↓
0.8			
0.9	B,C,D	↓	↓

Cap (pF)	Available Tolerance	Size	
		0402	0603
1.0	B,C,D	50V	200V
1.1	↓	↓	↓
1.2			
1.3	↓	↓	↓
1.4			
1.5	↓	↓	↓
1.6			
1.7	↓	↓	↓
1.8			
1.9	↓	↓	↓
2.0			
2.1	↓	↓	↓
2.2			
2.4	↓	↓	↓
2.7			
3.0	↓	↓	↓
3.3			
3.6	↓	↓	↓
3.9			
4.3	↓	↓	↓
4.7			
5.1	↓	↓	↓
5.6			
6.2	B,C,D	↓	↓
6.8	B,C,J,K,M		

Cap (pF)	Available Tolerance	Size	
		0402	0603
7.5	B,C,J,K,M	50V	200V
8.2	↓	↓	↓
9.1			
10	B,C,J,K,M	↓	↓
11	F,G,J,K,M		
12	↓	↓	↓
13			
15	↓	↓	↓
18			
20	↓	↓	↓
22			
24	↓	↓	↓
27			
30	↓	↓	↓
33			
36	↓	↓	↓
39			
43	↓	↓	↓
47			
51	↓	↓	↓
56			
68	↓	↓	↓
75			
82	↓	↓	↓
91			

Cap (pF)	Available Tolerance	Size	
		0402	0603
100	F,G,J,K,M	N/A	100V
110	↓	↓	↓
120			
130	↓	↓	↓
140			
150	↓	↓	↓
160			
180	↓	↓	↓
200			
220	↓	↓	↓
270			
300	↓	↓	↓
330			
360	↓	↓	↓
390			
430	↓	↓	↓
470			
510	↓	↓	↓
560			
620	↓	↓	↓
680			
750	↓	↓	↓
820			
910	↓	↓	↓
1000			

ULTRA LOW ESR, "U" SERIES

TYPICAL ESR vs. FREQUENCY
0402 "U" SERIES

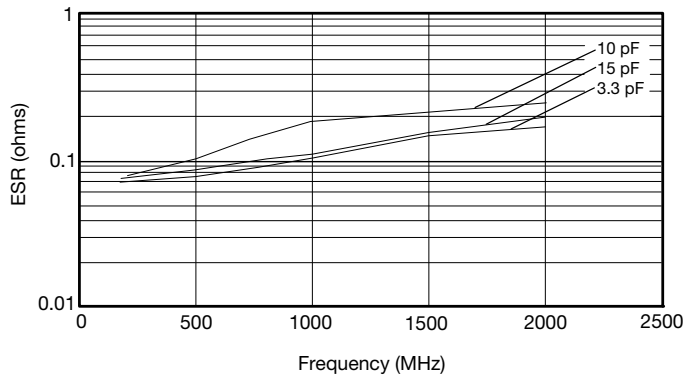

TYPICAL ESR vs. FREQUENCY
0603 "U" SERIES

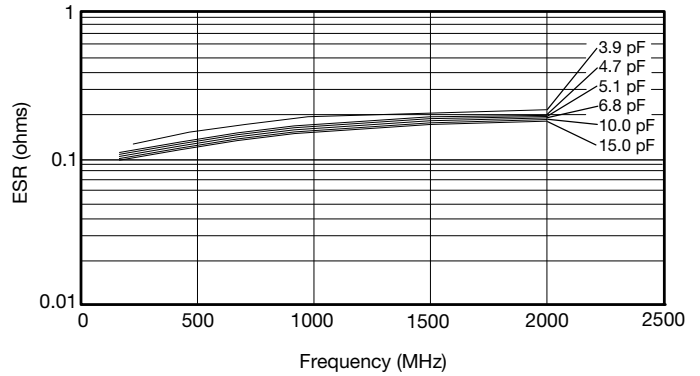

TYPICAL SERIES RESONANT FREQUENCY
"U" SERIES CHIP

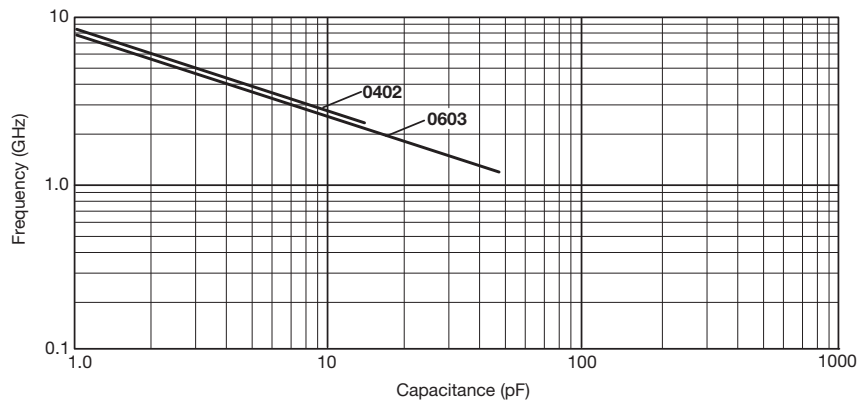

Designer Kits

Communication Kits “U” Series

“U” SERIES KITS

0402

Kit 5000 UZ			
Cap. Value pF	Tolerance	Cap. Value pF	Tolerance
0.5	B ($\pm 0.1\text{pF}$)	4.7	B ($\pm 0.1\text{pF}$)
1.0		5.6	
1.5		6.8	
1.8		8.2	
2.2		10.0	
2.4	J ($\pm 5\%$)	12.0	J ($\pm 5\%$)
3.0		15.0	
3.6			

***25 each of 15 values

0603

Kit 4000 UZ				
Cap. Value pF	Tolerance	Cap. Value pF	Tolerance	
1.0	B ($\pm 0.1\text{pF}$)	6.8	B ($\pm 0.1\text{pF}$)	
1.2		7.5		
1.5		8.2		
1.8		J ($\pm 5\%$)	10.0	J ($\pm 5\%$)
2.0			12.0	
2.4			15.0	
2.7			18.0	
3.0			22.0	
3.3			27.0	
3.9			33.0	
4.7			39.0	
5.6			47.0	

***25 each of 24 values

0805

Kit 3000 UZ			
Cap. Value pF	Tolerance	Cap. Value pF	Tolerance
1.0	B ($\pm 0.1\text{pF}$)	15.0	J ($\pm 5\%$)
1.5		18.0	
2.2		22.0	
2.4		24.0	
2.7		27.0	
3.0		33.0	
3.3		36.0	
3.9		39.0	
4.7		47.0	
5.6		56.0	
7.5		68.0	
8.2		82.0	
9.1		100.0	
10.0		J ($\pm 5\%$)	
12.0	160.0		

***25 each of 30 values

1210

Kit 3500 UZ				
Cap. Value pF	Tolerance	Cap. Value pF	Tolerance	
2.2	B ($\pm 0.1\text{pF}$)	36.0	J ($\pm 5\%$)	
2.7		39.0		
4.7		47.0		
5.1		51.0		
6.8		56.0		
8.2		68.0		
9.1		82.0		
10.0		J ($\pm 5\%$)		100.0
13.0	120.0			
15.0	130.0			
18.0	240.0			
20.0	300.0			
24.0	390.0			
27.0	470.0			
30.0	680.0			

***25 each of 30 values

X8R/X8L Dielectric

General Specifications

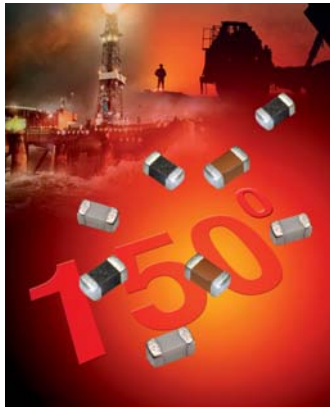

AVX has developed a range of multilayer ceramic capacitors designed for use in applications up to 150°C. These capacitors are manufactured with an X8R and an X8L dielectric material. X8R material has capacitance variation of ±15% between -55°C and +150°C. The X8L material has capacitance variation of ±15% between -55°C to 125°C and +15/-40% from +125°C to +150°C.

The need for X8R and X8L performance has been driven by customer requirements for parts that operate at elevated temperatures. They provide a highly reliable capacitor with low loss and stable capacitance over temperature.

They are ideal for automotive under the hood sensors, and various industrial applications. Typical industrial application would be drilling monitoring system. They can also be used as bulk capacitors for high temperature camera modules.

Both X8R and X8L dielectric capacitors are automotive AEC-Q200 qualified. Optional termination systems, tin, FLEXITERM® and conductive epoxy for hybrid applications are available. Providing this series with our FLEXITERM® termination system provides further advantage to customers by way of enhanced resistance to both, temperature cycling and mechanical damage.

PART NUMBER (see page 2 for complete part number explanation)

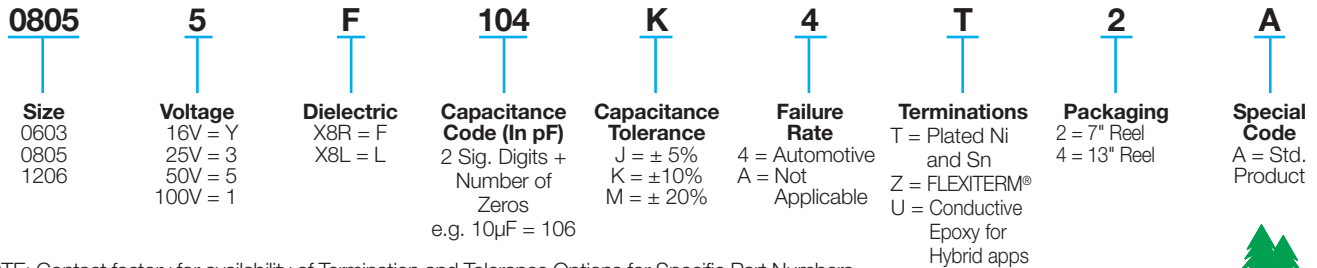

NOTE: Contact factory for availability of Termination and Tolerance Options for Specific Part Numbers.



X8R

SIZE			0603		0805		1206	
Soldering			Reflow/Wave		Reflow/Wave		Reflow/Wave	
	WVDC		25V	50V	25V	50V	25V	50V
331	Cap	330	G	G	J	J		
471	(pF)	470	G	G	J	J		
681		680	G	G	J	J		
102		1000	G	G	J	J	J	J
152		1500	G	G	J	J	J	J
222		2200	G	G	J	J	J	J
332		3300	G	G	J	J	J	J
472		4700	G	G	J	J	J	J
682		6800	G	G	J	J	J	J
103	Cap	0.01	G	G	J	J	J	J
153	(µF)	0.015	G	G	J	J	J	J
223		0.022	G	G	J	J	J	J
333		0.033	G	G	J	J	J	J
473		0.047	G	G	J	J	J	J
683		0.068	G		N	N	M	M
104		0.1			N	N	M	M
154		0.15			N	N	M	M
224		0.22			N		M	M
334		0.33					M	M
474		0.47					M	
684		0.68					M	
105		1					M	
WVDC			25V	50V	25V	50V	25V	50V
SIZE			0603		0805		1206	

X8L

SIZE			0603			0805			1206			
Soldering			Reflow/Wave			Reflow/Wave			Reflow/Wave			
	WVDC		25V	50V	100V	25V	50V	100V	16V	25V	50V	100V
331	Cap	330		G	G			J	J			
471	(pF)	470		G	G			J	J			
681		680		G	G			J	J			
102		1000		G	G			J	J			
152		1500		G	G			J	J		J	J
222		2200		G	G			J	J		J	J
332		3300		G	G			J	J		J	J
472		4700		G	G			J	J		J	J
682		6800		G	G			J	J		J	J
103	Cap	0.01		G	G			J	J		J	J
153	(µF)	0.015		G	G			J	J		J	J
223		0.022		G	G			J	J		J	J
333		0.033		G	G			J	J	N	J	J
473		0.047		G	G			J	J	N	J	J
683		0.068		G	G			J	J		J	J
104		0.1		G	G			J	J		J	M
154		0.15						J	N		J	J
224		0.22						N	N		J	J
334		0.33						N			J	M
474		0.47						N			M	P
684		0.68						N			M	P
105		1									M	
WVDC			25V	50V	100V	25V	50V	100V	16V	25V	50V	100V
SIZE			0603			0805			1206			

Letter	A	C	E	G	J	K	M	N	P	Q	X	Y	Z
Max. Thickness	0.33 (0.013)	0.56 (0.022)	0.71 (0.028)	0.90 (0.035)	0.94 (0.037)	1.02 (0.040)	1.27 (0.050)	1.40 (0.055)	1.52 (0.060)	1.78 (0.070)	2.29 (0.090)	2.54 (0.100)	2.79 (0.110)
	PAPER					EMBOSSED							

= AEC-Q200 Qualified

X8R/X8L Dielectric

General Specifications

APPLICATIONS FOR X8R AND X8L CAPACITORS

- All market sectors with a 150°C requirement
- Automotive on engine applications
- Oil exploration applications
- Hybrid automotive applications
 - Battery control
 - Inverter / converter circuits
 - Motor control applications
 - Water pump
- Hybrid commercial applications
 - Emergency circuits
 - Sensors
 - Temperature regulation

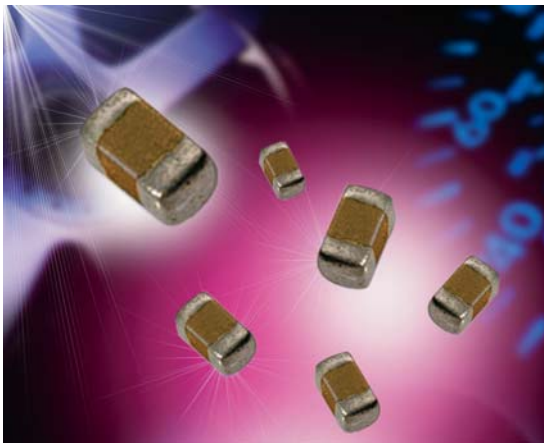

ADVANTAGES OF X8R AND X8L MLC CAPACITORS

- Both ranges are qualified to the highest automotive AEC-Q200 standards
- Excellent reliability compared to other capacitor technologies
- RoHS compliant
- Low ESR / ESL compared to other technologies
- Tin solder finish
- FLEXITERM® available
- Epoxy termination for hybrid available
- 100V range available

ENGINEERING TOOLS FOR HIGH VOLTAGE MLC CAPACITORS

- Samples
- Technical Articles
- Application Engineering
- Application Support

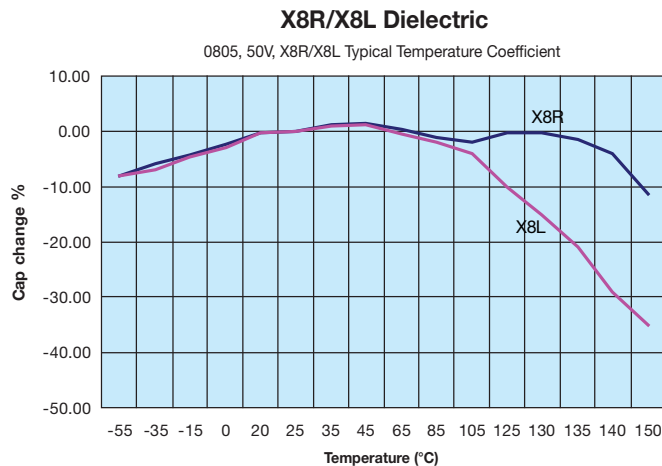

X8R/X8L Dielectric

Specifications and Test Methods

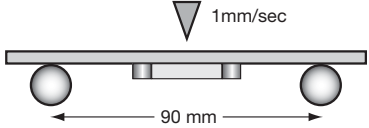
Parameter/Test		X8R/X8L Specification Limits	Measuring Conditions	
Operating Temperature Range		-55°C to +150°C	Temperature Cycle Chamber	
Capacitance		Within specified tolerance	Freq.: 1.0 kHz ± 10%	
Dissipation Factor		≤ 2.5% for ≥ 50V DC rating ≤ 3.5% for 25V DC and 16V DC rating	Voltage: 1.0Vrms ± .2V	
Insulation Resistance		100,000MΩ or 1000MΩ - μF, whichever is less	Charge device with rated voltage for 120 ± 5 secs @ room temp/humidity	
Dielectric Strength		No breakdown or visual defects	Charge device with 300% of rated voltage for 1-5 seconds, w/charge and discharge current limited to 50 mA (max) Note: Charge device with 150% of rated voltage for 500V devices.	
Resistance to Flexure Stresses	Appearance	No defects	Deflection: 2mm Test Time: 30 seconds 	
	Capacitance Variation	≤ ±12%		
	Dissipation Factor	Meets Initial Values (As Above)		
	Insulation Resistance	≥ Initial Value x 0.3		
Solderability		≥ 95% of each terminal should be covered with fresh solder	Dip device in eutectic solder at 230 ± 5°C for 5.0 ± 0.5 seconds	
Resistance to Solder Heat	Appearance	No defects, <25% leaching of either end terminal	Dip device in eutectic solder at 260°C for 60 seconds. Store at room temperature for 24 ± 2 hours before measuring electrical properties.	
	Capacitance Variation	≤ ±7.5%		
	Dissipation Factor	Meets Initial Values (As Above)		
	Insulation Resistance	Meets Initial Values (As Above)		
	Dielectric Strength	Meets Initial Values (As Above)		
Thermal Shock	Appearance	No visual defects	Step 1: -55°C ± 2°	30 ± 3 minutes
	Capacitance Variation	≤ ±7.5%	Step 2: Room Temp	≤ 3 minutes
	Dissipation Factor	Meets Initial Values (As Above)	Step 3: +125°C ± 2°	30 ± 3 minutes
	Insulation Resistance	Meets Initial Values (As Above)	Step 4: Room Temp	≤ 3 minutes
	Dielectric Strength	Meets Initial Values (As Above)	Repeat for 5 cycles and measure after 24 ± 2 hours at room temperature	
Load Life	Appearance	No visual defects	Charge device with 1.5 rated voltage (≤ 10V) in test chamber set at 150°C ± 2°C for 1000 hours (+48, -0) Remove from test chamber and stabilize at room temperature for 24 ± 2 hours before measuring.	
	Capacitance Variation	≤ ±12.5%		
	Dissipation Factor	≤ Initial Value x 2.0 (See Above)		
	Insulation Resistance	≥ Initial Value x 0.3 (See Above)		
	Dielectric Strength	Meets Initial Values (As Above)		
Load Humidity	Appearance	No visual defects	Store in a test chamber set at 85°C ± 2°C/ 85% ± 5% relative humidity for 1000 hours (+48, -0) with rated voltage applied. Remove from chamber and stabilize at room temperature and humidity for 24 ± 2 hours before measuring.	
	Capacitance Variation	≤ ±12.5%		
	Dissipation Factor	≤ Initial Value x 2.0 (See Above)		
	Insulation Resistance	≥ Initial Value x 0.3 (See Above)		
	Dielectric Strength	Meets Initial Values (As Above)		

X7R Dielectric

General Specifications

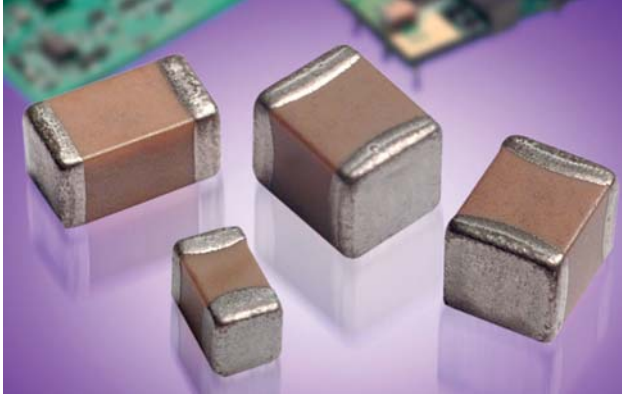

X7R formulations are called "temperature stable" ceramics and fall into EIA Class II materials. X7R is the most popular of these intermediate dielectric constant materials. Its temperature variation of capacitance is within $\pm 15\%$ from -55°C to $+125^{\circ}\text{C}$. This capacitance change is non-linear.

Capacitance for X7R varies under the influence of electrical operating conditions such as voltage and frequency.

X7R dielectric chip usage covers the broad spectrum of industrial applications where known changes in capacitance due to applied voltages are acceptable.



PART NUMBER (see page 2 for complete part number explanation)

0805	5	C	103	M	A	T	2	A
Size (L" x W")	Voltage 4V = 4 6.3V = 6 10V = Z 16V = Y 25V = 3 50V = 5 100V = 1 200V = 2 500V = 7	Dielectric X7R = C	Capacitance Code (In pF) 2 Sig. Digits + Number of Zeros	Capacitance Tolerance J = $\pm 5\%$ * K = $\pm 10\%$ M = $\pm 20\%$ * $\leq 1\mu\text{F}$ only, contact factory for additional values	Failure Rate A = Not Applicable	Terminations T = Plated Ni and Sn 7 = Gold Plated* Z = FLEXITERM®**	Packaging 2 = 7" Reel 4 = 13" Reel	Special Code A = Std. Product
						*Optional termination **See FLEXITERM® X7R section	Contact Factory For Multiples	

NOTE: Contact factory for availability of Termination and Tolerance Options for Specific Part Numbers.
Contact factory for non-specified capacitance values.

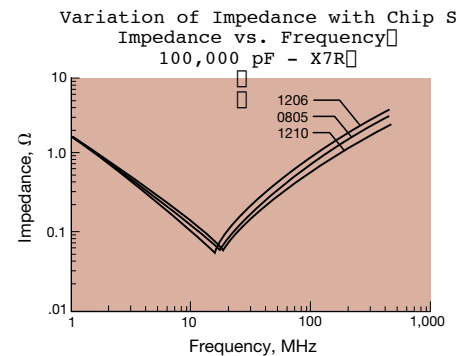
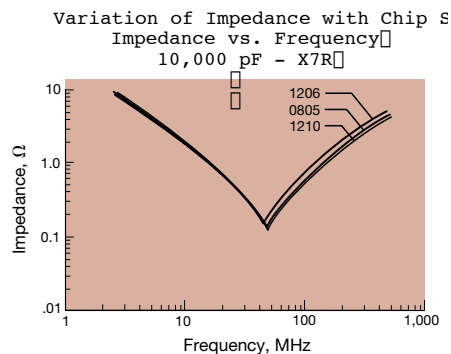
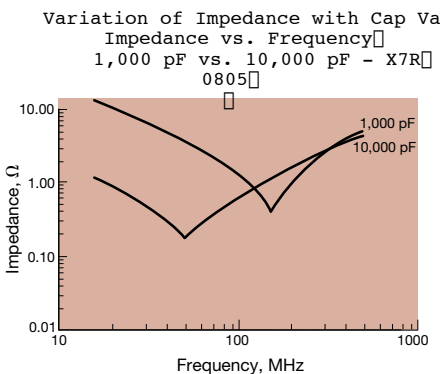
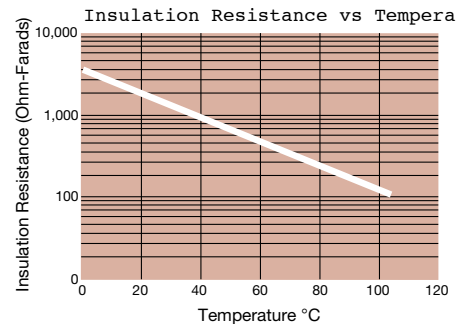
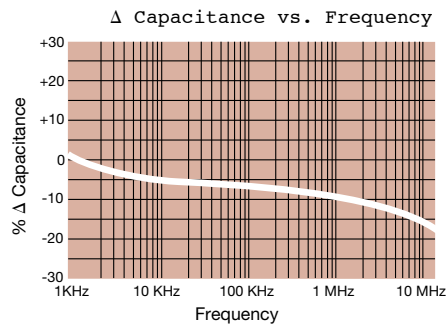
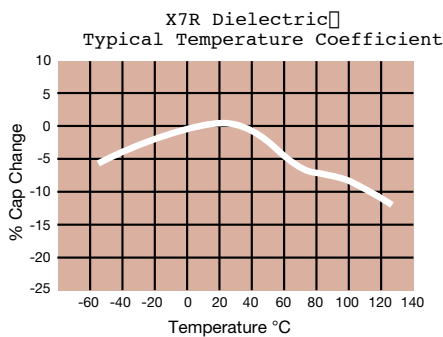

X7R Dielectric

Specifications and Test Methods

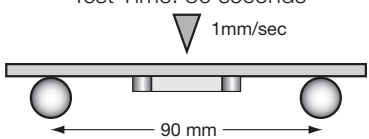
Parameter/Test		X7R Specification Limits	Measuring Conditions	
Operating Temperature Range		-55°C to +125°C	Temperature Cycle Chamber	
Capacitance		Within specified tolerance		
Dissipation Factor		$\leq 10\%$ for $\geq 50V$ DC rating $\leq 12.5\%$ for 25V DC rating $\leq 12.5\%$ for 25V and 16V DC rating $\leq 12.5\%$ for $\leq 10V$ DC rating	Freq.: 1.0 kHz $\pm 10\%$ Voltage: 1.0Vrms $\pm .2V$	
Insulation Resistance		100,000M Ω or 1000M Ω - μ F, whichever is less	Charge device with rated voltage for 120 ± 5 secs @ room temp/humidity	
Dielectric Strength		No breakdown or visual defects	Charge device with 300% of rated voltage for 1-5 seconds, w/charge and discharge current limited to 50 mA (max) Note: Charge device with 150% of rated voltage for 500V devices.	
Resistance to Flexure Stresses	Appearance	No defects	Deflection: 2mm Test Time: 30 seconds 	
	Capacitance Variation	$\leq \pm 12\%$		
	Dissipation Factor	Meets Initial Values (As Above)		
	Insulation Resistance	\geq Initial Value $\times 0.3$		
Solderability		$\geq 95\%$ of each terminal should be covered with fresh solder	Dip device in eutectic solder at 230 $\pm 5^\circ$ C for 5.0 ± 0.5 seconds	
Resistance to Solder Heat	Appearance	No defects, <25% leaching of either end terminal	Dip device in eutectic solder at 260°C for 60 seconds. Store at room temperature for 24 ± 2 hours before measuring electrical properties.	
	Capacitance Variation	$\leq \pm 7.5\%$		
	Dissipation Factor	Meets Initial Values (As Above)		
	Insulation Resistance	Meets Initial Values (As Above)		
	Dielectric Strength	Meets Initial Values (As Above)		
Thermal Shock	Appearance	No visual defects	Step 1: -55°C $\pm 2^\circ$	30 ± 3 minutes
	Capacitance Variation	$\leq \pm 7.5\%$	Step 2: Room Temp	≤ 3 minutes
	Dissipation Factor	Meets Initial Values (As Above)	Step 3: +125°C $\pm 2^\circ$	30 ± 3 minutes
	Insulation Resistance	Meets Initial Values (As Above)	Step 4: Room Temp	≤ 3 minutes
	Dielectric Strength	Meets Initial Values (As Above)	Repeat for 5 cycles and measure after 24 ± 2 hours at room temperature	
Load Life	Appearance	No visual defects	Charge device with 1.5 rated voltage ($\leq 10V$) in test chamber set at 125°C $\pm 2^\circ$ C for 1000 hours (+48, -0) Remove from test chamber and stabilize at room temperature for 24 ± 2 hours before measuring.	
	Capacitance Variation	$\leq \pm 12.5\%$		
	Dissipation Factor	\leq Initial Value $\times 2.0$ (See Above)		
	Insulation Resistance	\geq Initial Value $\times 0.3$ (See Above)		
	Dielectric Strength	Meets Initial Values (As Above)		
Load Humidity	Appearance	No visual defects	Store in a test chamber set at 85°C $\pm 2^\circ$ C/ 85% $\pm 5\%$ relative humidity for 1000 hours (+48, -0) with rated voltage applied. Remove from chamber and stabilize at room temperature and humidity for 24 ± 2 hours before measuring.	
	Capacitance Variation	$\leq \pm 12.5\%$		
	Dissipation Factor	\leq Initial Value $\times 2.0$ (See Above)		
	Insulation Resistance	\geq Initial Value $\times 0.3$ (See Above)		
	Dielectric Strength	Meets Initial Values (As Above)		

X7R Dielectric

Capacitance Range

PREFERRED SIZES ARE SHADED

SIZE	0101*	0201	0402	0603	0805	1206	
Soldering	Reflow Only	Reflow Only	Reflow/Wave	Reflow/Wave	Reflow/Wave	Reflow/Wave	
Packaging	Paper/Embossed	All Paper	All Paper	All Paper	Paper/Embossed	Paper/Embossed	
(L) Length	mm (in.)	0.40 ± 0.02 (0.016 ± 0.0008)	0.60 ± 0.09 (0.024 ± 0.004)	1.00 ± 0.10 (0.040 ± 0.004)	1.60 ± 0.15 (0.063 ± 0.006)	2.01 ± 0.20 (0.079 ± 0.008)	3.20 ± 0.20 (0.126 ± 0.008)
(W) Width	mm (in.)	0.20 ± 0.02 (0.008 ± 0.0008)	0.30 ± 0.09 (0.011 ± 0.004)	0.50 ± 0.10 (0.020 ± 0.004)	0.81 ± 0.15 (0.032 ± 0.006)	1.25 ± 0.20 (0.049 ± 0.008)	1.60 ± 0.20 (0.063 ± 0.008)
(t) Terminal	mm (in.)	0.10 ± 0.04 (0.004 ± 0.0016)	0.15 ± 0.05 (0.006 ± 0.002)	0.25 ± 0.15 (0.010 ± 0.006)	0.35 ± 0.15 (0.014 ± 0.006)	0.50 ± 0.25 (0.020 ± 0.010)	0.50 ± 0.25 (0.020 ± 0.010)
WDC	16	10 16 25 50	6.3 10 16 25 50	6.3 10 16 25 50 100 200	6.3 10 16 25 50 100 200	6.3 10 16 25 50 100 200 500	
Cap 100 101	B	A A A A	C C C	G G G			
150 151	B	A A A A	C C C	G G G			
220 221	B	A A A A	C C C	G G G			
330 331	B	A A A A	C C C	G G G	J J J J J J		K
470 471	B	A A A A	C C C	G G G	J J J J J J		K
680 681	B	A A A	C C C	G G G	J J J J J J		K
1000 102	B	A A A	C C C C	G G G	J J J J J J		K
1500 152	B	A A A	C C C C	G G G	J J J J J J	J J J J J J	M
2200 222	B	A A A	C C C C	G G G	J J J J J J	J J J J J J	M
3300 332		A A A	C C C C	G G G	J J J J J J	J J J J J J	M
4700 472		A A A	C C C C	G G G	J J J J J J	J J J J J J	M
6800 682		A A A	C C C C	G G G	J J J J J J	J J J J J J	P
Cap 0.01 103		A A A	C C C C	G G G	J J J J J J	J J J J J J	P
0.015 153			C C C C	G G G	J J J J J J	J J J J J J	P
0.022 223			C C C C	G G G	J J J J J J	J J J J J J	X
0.033 333			C C C C	G G G	J J J J J J	J J J J J J	X
0.047 473			C C C C	G G G	J J J J J J	J J J J J J	M
0.068 683			C C C C	G G G	J J J J J J	J J J J J J	P
0.1 104			C C C C	G G G	J J J J J J	J J J J J J	P
0.15 154				G G G G	J J J J N N	J J J J J J	Q
0.22 224			C	G G J J	J J N N N N	J J J J J J	Q
0.33 334				J J J J	N N N N N N	J J M P Q	Q
0.47 474			C	J J J J J J	N N N N N N	M M M P Q	Q
0.68 684				J J J J	N N N N	M M Q Q Q	Q
1.0 105			C	J J J J	N N N N	M M Q Q Q	Q
2.2 225				J J J J	P P P P**	Q Q Q Q Q**	Q
4.7 475					P P P	Q Q Q Q	Q
10 106					P P	Q Q Q	
22 226						Q Q	
47 476							
100 107							
WDC	16	10 16 25 50	6.3 10 16 25 50	6.3 10 16 25 50 100 200	6.3 10 16 25 50 100 200	6.3 10 16 25 50 100 200 500	
SIZE	0101	0201	0402	0603	0805	1206	

Letter	A	B	C	E	G	J	K	M	N	P	Q	X	Y	Z
Max. Thickness	0.33 (0.013)	0.22 (0.009)	0.56 (0.022)	0.71 (0.028)	0.90 (0.035)	0.94 (0.037)	1.02 (0.040)	1.27 (0.050)	1.40 (0.055)	1.52 (0.060)	1.80 (0.071)	2.29 (0.090)	2.54 (0.100)	2.79 (0.110)
	PAPER						EMBOSSSED							

PAPER and EMBOSSSED available for 01005

NOTE: Contact factory for non-specified capacitance values

*EIA 01005

**Contact Factory for Specifications

X7S Dielectric

General Specifications

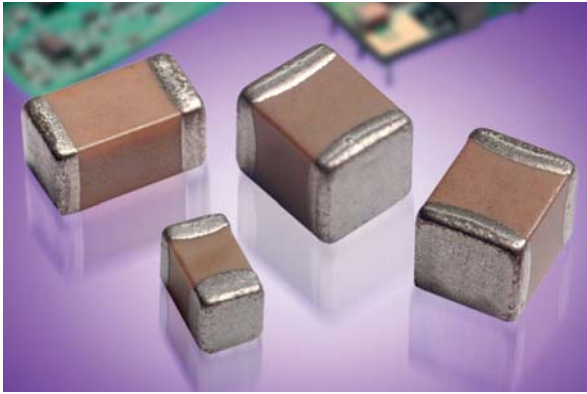

GENERAL DESCRIPTION

X7S formulations are called “temperature stable” ceramics and fall into EIA Class II materials. Its temperature variation of capacitance is within $\pm 22\%$ from -55°C to $+125^{\circ}\text{C}$. This capacitance change is non-linear.

Capacitance for X7S varies under the influence of electrical operating conditions such as voltage and frequency.

X7S dielectric chip usage covers the broad spectrum of industrial applications where known changes in capacitance due to applied voltages are acceptable.

PART NUMBER (see page 2 for complete part number explanation)

1206

Size
(L" x W")

Z

Voltage
4 = 4V
6 = 6.3V
Z = 10V
Y = 16V
3 = 25V
5 = 50V
1 = 100V
2 = 200V

Z

Dielectric
Z = X7S

105

Capacitance Code (In pF)
2 Sig. Digits + Number of Zeros

M

Capacitance Tolerance
K = $\pm 10\%$
M = $\pm 20\%$

A

Failure Rate
A = N/A

T

Terminations
T = Plated Ni and Sn

2

Packaging
2 = 7" Reel
4 = 13" Reel

A

Special Code
A = Std. Product



NOTE: Contact factory for availability of Tolerance Options for Specific Part Numbers.

TYPICAL ELECTRICAL CHARACTERISTICS

**X7S Dielectric
Typical Temperature Coefficient**

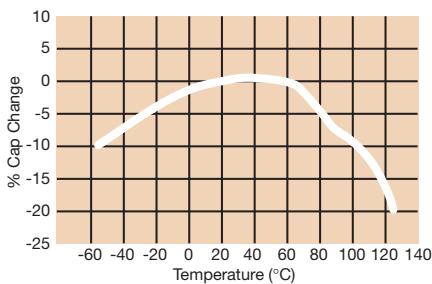

Δ Capacitance vs. Frequency

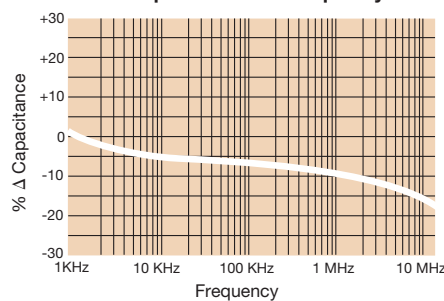

Insulation Resistance vs Temperature

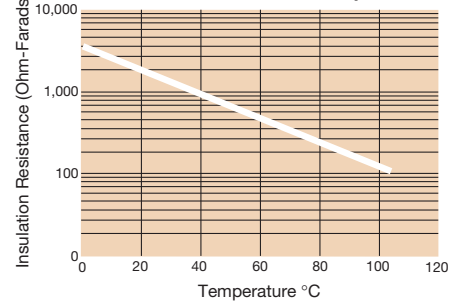

**Variation of Impedance with Cap Value
Impedance vs. Frequency
1,000 pF vs. 10,000 pF - X7S
0805**

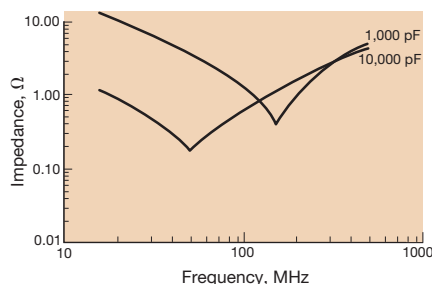

**Variation of Impedance with Chip Size
Impedance vs. Frequency
10,000 pF - X7S**

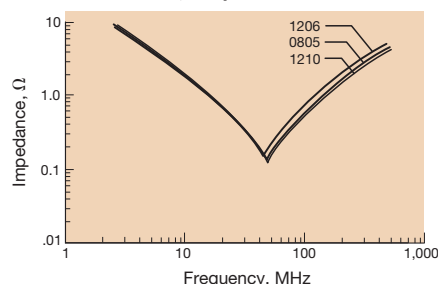

**Variation of Impedance with Chip Size
Impedance vs. Frequency
100,000 pF - X7S**

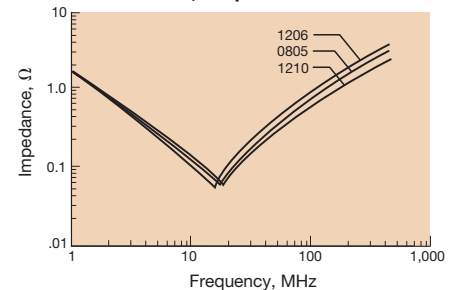

X7S Dielectric

Specifications and Test Methods

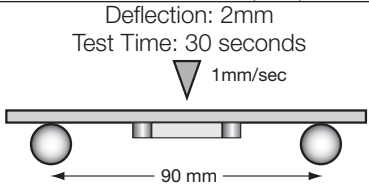
Parameter/Test		X7S Specification Limits	Measuring Conditions	
Operating Temperature Range		-55°C to +125°C	Temperature Cycle Chamber	
Capacitance		Within specified tolerance	Freq.: 1.0 kHz ± 10% Voltage: 1.0Vrms ± .2V For Cap > 10 µF, 0.5Vrms @ 120Hz	
Dissipation Factor		≤ 5.0% for ≥ 100V DC rating ≤ 5.0% for ≥ 25V DC rating ≤ 10.0% for ≥ 10V DC rating ≤ 10.0% for ≤ 10V DC rating		
Insulation Resistance		100,000MΩ or 1000MΩ - µF, whichever is less	Charge device with rated voltage for 120 ± 5 secs @ room temp/humidity	
Dielectric Strength		No breakdown or visual defects	Charge device with 300% of rated voltage for 1-5 seconds, w/charge and discharge current limited to 50 mA (max)	
Resistance to Flexure Stresses	Appearance	No defects	Deflection: 2mm Test Time: 30 seconds 	
	Capacitance Variation	≤ ±12%		
	Dissipation Factor	Meets Initial Values (As Above)		
	Insulation Resistance	≥ Initial Value x 0.3		
Solderability		≥ 95% of each terminal should be covered with fresh solder	Dip device in eutectic solder at 230 ± 5°C for 5.0 ± 0.5 seconds	
Resistance to Solder Heat	Appearance	No defects, <25% leaching of either end terminal	Dip device in eutectic solder at 260°C for 60 seconds. Store at room temperature for 24 ± 2 hours before measuring electrical properties.	
	Capacitance Variation	≤ ±7.5%		
	Dissipation Factor	Meets Initial Values (As Above)		
	Insulation Resistance	Meets Initial Values (As Above)		
	Dielectric Strength	Meets Initial Values (As Above)		
Thermal Shock	Appearance	No visual defects	Step 1: -55°C ± 2°	30 ± 3 minutes
	Capacitance Variation	≤ ±7.5%	Step 2: Room Temp	≤ 3 minutes
	Dissipation Factor	Meets Initial Values (As Above)	Step 3: +125°C ± 2°	30 ± 3 minutes
	Insulation Resistance	Meets Initial Values (As Above)	Step 4: Room Temp	≤ 3 minutes
	Dielectric Strength	Meets Initial Values (As Above)	Repeat for 5 cycles and measure after 24 ± 2 hours at room temperature	
Load Life	Appearance	No visual defects	Charge device with 1.5 rated voltage (≤ 10V) in test chamber set at 125°C ± 2°C for 1000 hours (+48, -0) Remove from test chamber and stabilize at room temperature for 24 ± 2 hours before measuring.	
	Capacitance Variation	≤ ±12.5%		
	Dissipation Factor	≤ Initial Value x 2.0 (See Above)		
	Insulation Resistance	≥ Initial Value x 0.3 (See Above)		
	Dielectric Strength	Meets Initial Values (As Above)		
Load Humidity	Appearance	No visual defects	Store in a test chamber set at 85°C ± 2°C/ 85% ± 5% relative humidity for 1000 hours (+48, -0) with rated voltage applied. Remove from chamber and stabilize at room temperature and humidity for 24 ± 2 hours before measuring.	
	Capacitance Variation	≤ ±12.5%		
	Dissipation Factor	≤ Initial Value x 2.0 (See Above)		
	Insulation Resistance	≥ Initial Value x 0.3 (See Above)		
	Dielectric Strength	Meets Initial Values (As Above)		

X5R Dielectric

General Specifications

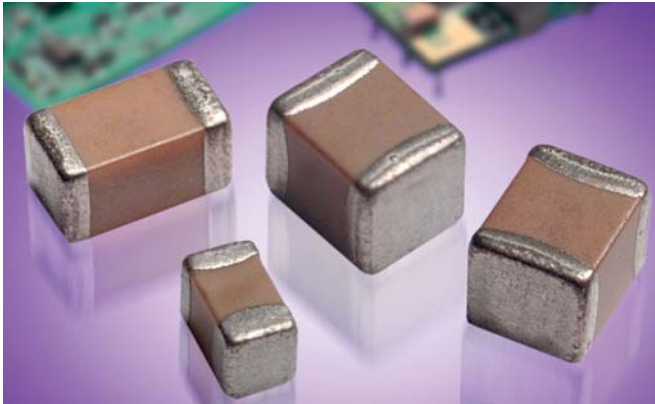

GENERAL DESCRIPTION

- General Purpose Dielectric for Ceramic Capacitors
- EIA Class II Dielectric
- Temperature variation of capacitance is within $\pm 15\%$ from -55°C to $+85^{\circ}\text{C}$
- Well suited for decoupling and filtering applications
- Available in High Capacitance values (up to $100\mu\text{F}$)

PART NUMBER (see page 2 for complete part number explanation)

1210

Size
(L" x W")
0101**
0201
0402
0603
0805
1206
1210
1812

4

Voltage
4 = 4V
6 = 6.3V
Z = 10V
Y = 16V
3 = 25V
D = 35V
5 = 50V
1 = 100V

D

Dielectric
D = X5R

107

Capacitance Code (In pF)
2 Sig. Digits +
Number of
Zeros

M

Capacitance Tolerance
K = $\pm 10\%$
M = $\pm 20\%$

A

Failure Rate
A = N/A

T

Terminations
T = Plated Ni
and Sn

2

Packaging
2 = 7" Reel
4 = 13" Reel
U = 4mm TR
(01005)

A

Special Code
A = Std.



**EIA 01005

NOTE: Contact factory for availability of Tolerance Options for Specific Part Numbers.
Contact factory for non-specified capacitance values.

TYPICAL ELECTRICAL CHARACTERISTICS

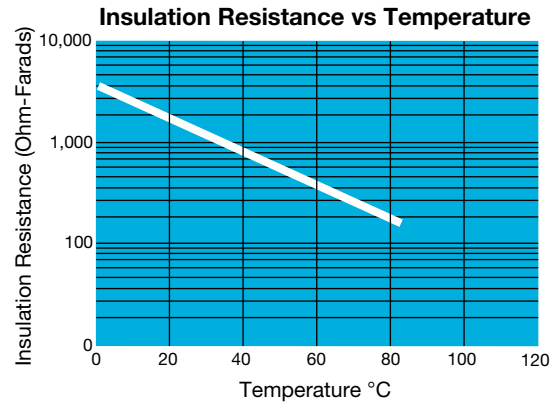
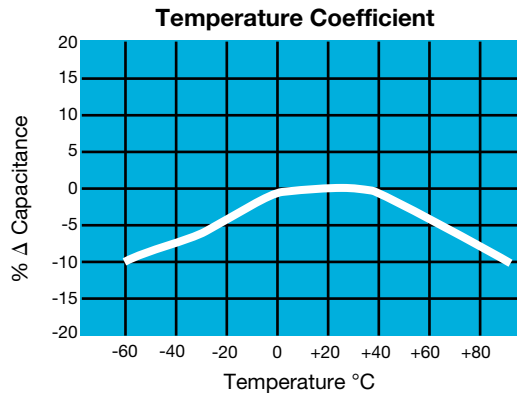

X5R Dielectric

Specifications and Test Methods

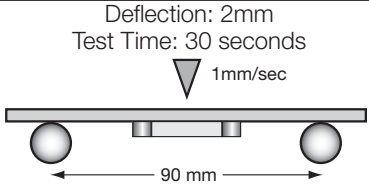
Parameter/Test		X5R Specification Limits	Measuring Conditions	
Operating Temperature Range		-55°C to +85°C	Temperature Cycle Chamber	
Capacitance		Within specified tolerance	Freq.: 1.0 kHz ± 10% Voltage: 1.0Vrms ± .2V For Cap > 10 µF, 0.5Vrms @ 120Hz	
Dissipation Factor		≤ 2.5% for ≥ 50V DC rating ≤ 3.0% for 25V, 35V DC rating ≤ 12.5% Max. for 16V DC rating and lower Contact Factory for DF by PN		
Insulation Resistance		10,000MΩ or 500MΩ - µF, whichever is less	Charge device with rated voltage for 120 ± 5 secs @ room temp/humidity	
Dielectric Strength		No breakdown or visual defects	Charge device with 300% of rated voltage for 1-5 seconds, w/charge and discharge current limited to 50 mA (max)	
Resistance to Flexure Stresses	Appearance	No defects	Deflection: 2mm Test Time: 30 seconds 	
	Capacitance Variation	≤ ±12%		
	Dissipation Factor	Meets Initial Values (As Above)		
	Insulation Resistance	≥ Initial Value x 0.3		
Solderability		≥ 95% of each terminal should be covered with fresh solder	Dip device in eutectic solder at 230 ± 5°C for 5.0 ± 0.5 seconds	
Resistance to Solder Heat	Appearance	No defects, <25% leaching of either end terminal	Dip device in eutectic solder at 260°C for 60 seconds. Store at room temperature for 24 ± 2 hours before measuring electrical properties.	
	Capacitance Variation	≤ ±7.5%		
	Dissipation Factor	Meets Initial Values (As Above)		
	Insulation Resistance	Meets Initial Values (As Above)		
	Dielectric Strength	Meets Initial Values (As Above)		
Thermal Shock	Appearance	No visual defects	Step 1: -55°C ± 2°	30 ± 3 minutes
	Capacitance Variation	≤ ±7.5%	Step 2: Room Temp	≤ 3 minutes
	Dissipation Factor	Meets Initial Values (As Above)	Step 3: +85°C ± 2°	30 ± 3 minutes
	Insulation Resistance	Meets Initial Values (As Above)	Step 4: Room Temp	≤ 3 minutes
	Dielectric Strength	Meets Initial Values (As Above)	Repeat for 5 cycles and measure after 24 ± 2 hours at room temperature	
	Load Life		Meets Initial Values (As Above)	Charge device with 1.5X rated voltage in test chamber set at 85°C ± 2°C for 1000 hours (+48, -0). Note: Contact factory for *optional specification part numbers that are tested at < 1.5X rated voltage.
Load Humidity	Appearance	No visual defects	Remove from test chamber and stabilize at room temperature for 24 ± 2 hours before measuring.	
	Capacitance Variation	≤ ±12.5%		
	Dissipation Factor	≤ Initial Value x 2.0 (See Above)		
	Insulation Resistance	≥ Initial Value x 0.3 (See Above)		
	Dielectric Strength	Meets Initial Values (As Above)		
Load Humidity	Appearance	No visual defects	Store in a test chamber set at 85°C ± 2°C/ 85% ± 5% relative humidity for 1000 hours (+48, -0) with rated voltage applied.	
	Capacitance Variation	≤ ±12.5%		
	Dissipation Factor	≤ Initial Value x 2.0 (See Above)		
	Insulation Resistance	≥ Initial Value x 0.3 (See Above)		
	Dielectric Strength	Meets Initial Values (As Above)		

X5R Dielectric

Capacitance Range

PREFERRED SIZES ARE SHADED

Case Size	0101*			0201			0402					0603					0805											
Soldering	Reflow Only			Reflow Only			Reflow/Wave					Reflow/Wave					Reflow/Wave											
Packaging	Paper/Embossed			All Paper			All Paper					All Paper					Paper/Embossed											
(L) Length	mm	0.40 ± 0.02		0.60 ± 0.09			1.00 ± 0.10					1.60 ± 0.15					2.01 ± 0.20											
	(in.)	(0.016 ± 0.0008)		(0.024 ± 0.004)			(0.040 ± 0.004)					(0.063 ± 0.006)					(0.079 ± 0.008)											
(W) Width	mm	0.20 ± 0.02		0.30 ± 0.09			0.50 ± 0.10					0.81 ± 0.15					1.25 ± 0.20											
	(in.)	(0.008 ± 0.0008)		(0.011 ± 0.004)			(0.020 ± 0.004)					(0.032 ± 0.006)					(0.049 ± 0.008)											
(t) Terminal	mm	0.10 ± 0.04		0.15 ± 0.05			0.25 ± 0.15					0.35 ± 0.15					0.50 ± 0.25											
	(in.)	(0.004 ± 0.0016)		(0.006 ± 0.002)			(0.010 ± 0.006)					(0.014 ± 0.006)					(0.020 ± 0.010)											
Voltage:		6.3	16	4	6.3	10	16	25	4	6.3	10	16	25	50	4	6.3	10	16	25	35	50	4	6.3	10	16	25	35	50
Cap (pF)	100	101	B				A																					
	150	151	B				A																					
	220	221	B				A						C															
	330	331	B				A						C															
	470	471	B				A						C															
	680	681	B				A						C															
	1000	102	B				A	A					C															
	1500	152	B	B			A	A					C															
	2200	222	B	B			A	A	A				C															
	3300	332	B	B			A	A	A				C															
	4700	472	B	B			A	A	A				C												G			
	6800	682	B	B			A	A	A				C												G			
Cap (µF)	0.01	103	B	B			A	A	A				C															
	0.015	153	B										C															
	0.022	223	B				A						C	C														N
	0.033	333	B										C															N
	0.047	473	B				A						C	C														N
	0.068	683	B										C															N
	0.1	104	B				A	A					C	C	C	C												N
	0.15	154																										N
	0.22	224	B				A	A	A				C	C	C													N
	0.33	334																										N
	0.47	474					A	A					C	C	C	C												N
	0.68	684																										N
	1.0	105					F	F	F	F			C	C	C	C	E											N
	1.5	155																										N
	2.2	225					F	F	F				C	C	C													N
	3.3	335																										N
	4.7	475																										N
	10	106											E	E	E	E												N
	22	226											E	E														N
	47	476																										N
	100	107																										N
Voltage:		6.3	16	4	6.3	10	16	25	4	6.3	10	16	25	50	4	6.3	10	16	25	35	50	4	6.3	10	16	25	35	50
Case Size	0101*			0201			0402					0603					0805											

Letter	A	B	C	E	F	G	J	K	M	N	P	Q	X	Y	Z	
Max.	0.33	0.22	0.56	0.71	0.40	0.90	0.94	1.02	1.27	1.40	1.52	1.78	2.29	2.54	2.79	
Thickness	(0.013)	(0.009)	(0.022)	(0.028)	(0.016)	(0.035)	(0.037)	(0.040)	(0.050)	(0.055)	(0.060)	(0.070)	(0.090)	(0.100)	(0.110)	
	PAPER							EMBOSED								

PAPER and EMBOSED available for 01005

NOTE: Contact factory for non-specified capacitance values

*EIA 01005

X5R Dielectric

Capacitance Range

PREFERRED SIZES ARE SHADED

Case Size	1206								1210								1812							
Soldering	Reflow/Wave								Reflow Only								Reflow Only							
Packaging	Paper/Embossed								Paper/Embossed								All Embossed							
(L) Length mm (in.)	3.20 ± 0.20 (0.126 ± 0.008)								3.20 ± 0.20 (0.126 ± 0.008)								4.50 ± 0.30 (0.177 ± 0.012)							
(W) Width mm (in.)	1.60 ± 0.20 (0.063 ± 0.008)								2.50 ± 0.20 (0.098 ± 0.008)								3.20 ± 0.20 (0.126 ± 0.008)							
(t) Terminal mm (in.)	0.50 ± 0.25 (0.020 ± 0.010)								0.50 ± 0.25 (0.020 ± 0.010)								0.61 ± 0.36 (0.024 ± 0.014)							
Voltage:	4	6.3	10	16	25	35	50	100	4	6.3	10	16	25	35	50	4	6.3	10	16	25	35	50		
Cap (pF) 100 101																								
150 151																								
220 221																								
330 331																								
470 471																								
680 681																								
1000 102																								
1500 152																								
2200 222																								
3300 332																								
4700 472																								
6800 682																								
Cap (µF) 0.01 103																								
0.015 153																								
0.022 223																								
0.033 333																								
0.047 473																								
0.068 683																								
0.1 104																								
0.15 154																								
0.22 224																								
0.33 334																								
0.47 474					Q	Q								X	X									
0.68 684																								
1.0 105					Q	Q	Q	Q					X	X	X									
1.5 155																								
2.2 225			Q	Q	Q	Q	Q	Q					X	Z	Z									
3.3 335		Q	Q																					
4.7 475	X	X	X	X	X	X	X	X			Q	Q	Z	Z	Z									
10 106	X	X	X	X	X	X	X	X			X	X	Z	Z	Z	Z				Z				
22 226	X	X	X	X	X						Z	Z	Z	Z	Z									
47 476	X	X	X								Z	Z	Z	Z	Z									
100 107	X	X									Z	Z	Z	Z										
Voltage:	4	6.3	10	16	25	35	50	100	4	6.3	10	16	25	35	50	4	6.3	10	16	25	35	50		
Case Size	1206								1210								1812							

Letter	A	B	C	E	G	J	K	M	N	P	Q	X	Y	Z
Max. Thickness	0.33 (0.013)	0.22 (0.009)	0.56 (0.022)	0.71 (0.028)	0.90 (0.035)	0.94 (0.037)	1.02 (0.040)	1.27 (0.050)	1.40 (0.055)	1.52 (0.060)	1.78 (0.070)	2.29 (0.090)	2.54 (0.100)	2.79 (0.110)
	PAPER						EMBOSSSED							

NOTE: Contact factory for non-specified capacitance values

*EIA 01005

Y5V Dielectric

General Specifications

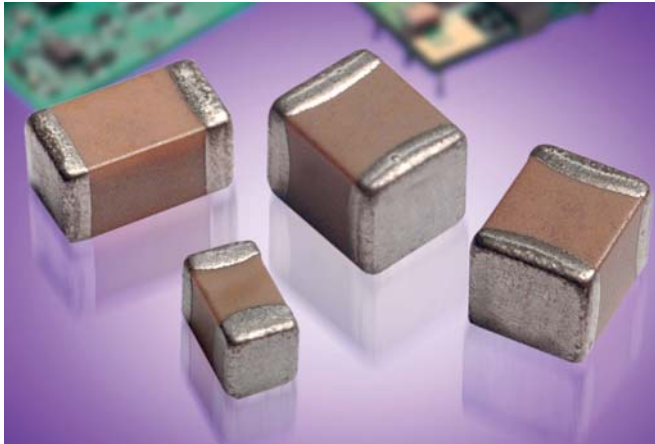

Y5V formulations are for general-purpose use in a limited temperature range. They have a wide temperature characteristic of +22% -82% capacitance change over the operating temperature range of -30°C to +85°C.

These characteristics make Y5V ideal for decoupling applications within limited temperature range.



PART NUMBER (see page 2 for complete part number explanation)

0805

Size
(L" x W")

3

Voltage
6.3V = 6
10V = Z
16V = Y
25V = 3
50V = 5

G

Dielectric
Y5V = G

104

Capacitance Code (In pF)
2 Sig. Digits + Number of Zeros

Z

Capacitance Tolerance
Z = +80 -20%

A

Failure Rate
A = Not Applicable

T

Terminations
T = Plated Ni and Sn

2

Packaging
2 = 7" Reel
4 = 13" Reel

A

Special Code
A = Std. Product

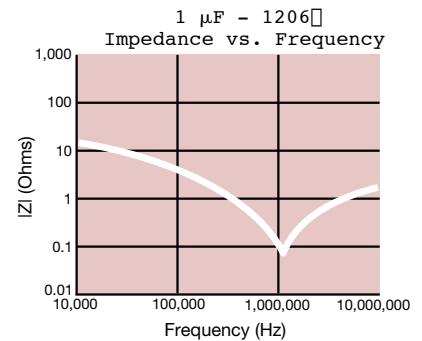
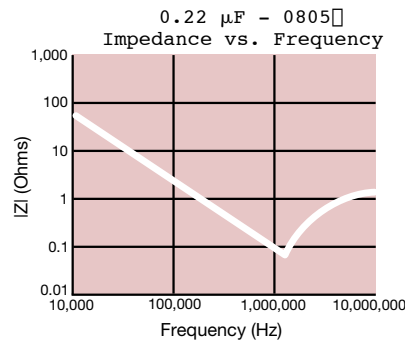
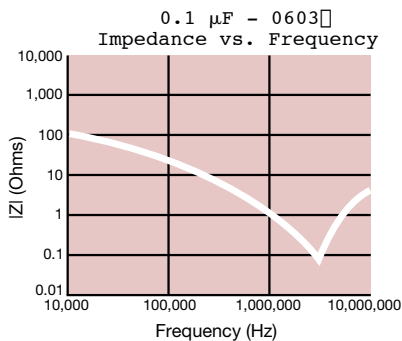
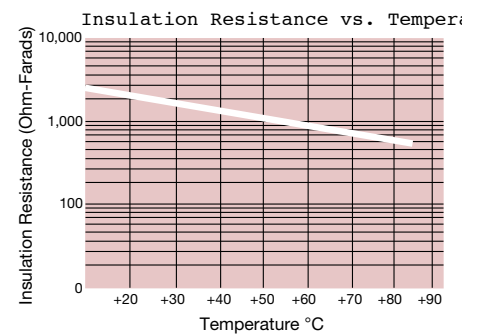
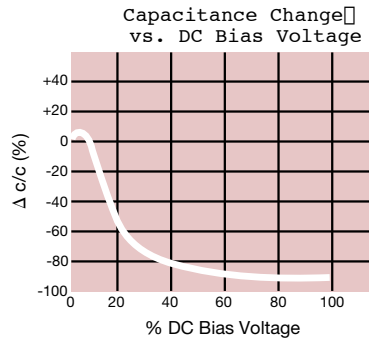
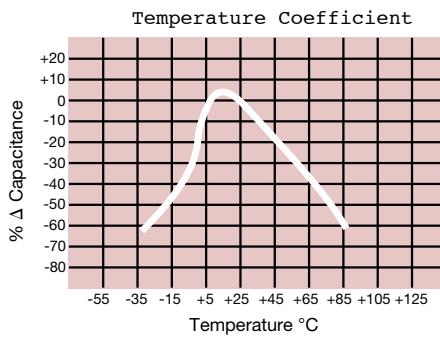

Y5V Dielectric

Specifications and Test Methods

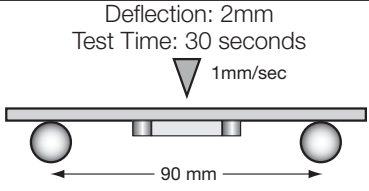
Parameter/Test		Y5V Specification Limits	Measuring Conditions	
Operating Temperature Range		-30°C to +85°C	Temperature Cycle Chamber	
Capacitance		Within specified tolerance	Freq.: 1.0 kHz \pm 10% Voltage: 1.0Vrms \pm .2V For Cap > 10 μ F, 0.5Vrms @ 120Hz	
Dissipation Factor		\leq 5.0% for \geq 50V DC rating \leq 7.0% for 25V DC rating \leq 9.0% for 16V DC rating \leq 12.5% for \leq 10V DC rating		
Insulation Resistance		10,000M Ω or 500M Ω - μ F, whichever is less	Charge device with rated voltage for 120 \pm 5 secs @ room temp/humidity	
Dielectric Strength		No breakdown or visual defects	Charge device with 300% of rated voltage for 1-5 seconds, w/charge and discharge current limited to 50 mA (max)	
Resistance to Flexure Stresses	Appearance	No defects	Deflection: 2mm Test Time: 30 seconds 	
	Capacitance Variation	\leq \pm 30%		
	Dissipation Factor	Meets Initial Values (As Above)		
	Insulation Resistance	\geq Initial Value x 0.1		
Solderability		\geq 95% of each terminal should be covered with fresh solder	Dip device in eutectic solder at 230 \pm 5°C for 5.0 \pm 0.5 seconds	
Resistance to Solder Heat	Appearance	No defects, <25% leaching of either end terminal	Dip device in eutectic solder at 260°C for 60 seconds. Store at room temperature for 24 \pm 2 hours before measuring electrical properties.	
	Capacitance Variation	\leq \pm 20%		
	Dissipation Factor	Meets Initial Values (As Above)		
	Insulation Resistance	Meets Initial Values (As Above)		
	Dielectric Strength	Meets Initial Values (As Above)		
Thermal Shock	Appearance	No visual defects	Step 1: -30°C \pm 2°	30 \pm 3 minutes
	Capacitance Variation	\leq \pm 20%	Step 2: Room Temp	\leq 3 minutes
	Dissipation Factor	Meets Initial Values (As Above)	Step 3: +85°C \pm 2°	30 \pm 3 minutes
	Insulation Resistance	Meets Initial Values (As Above)	Step 4: Room Temp	\leq 3 minutes
	Dielectric Strength	Meets Initial Values (As Above)	Repeat for 5 cycles and measure after 24 \pm 2 hours at room temperature	
	Load Life		Meets Initial Values (As Above)	Charge device with twice rated voltage in test chamber set at 85°C \pm 2°C for 1000 hours (+48, -0)
Load Humidity	Appearance	No visual defects	Remove from test chamber and stabilize at room temperature for 24 \pm 2 hours before measuring.	
	Capacitance Variation	\leq \pm 30%		
	Dissipation Factor	\leq Initial Value x 1.5 (See Above)		
	Insulation Resistance	\geq Initial Value x 0.1 (See Above)		
	Dielectric Strength	Meets Initial Values (As Above)		
Load Humidity	Appearance	No visual defects	Store in a test chamber set at 85°C \pm 2°C/ 85% \pm 5% relative humidity for 1000 hours (+48, -0) with rated voltage applied.	
	Capacitance Variation	\leq \pm 30%		
	Dissipation Factor	\leq Initial Value x 1.5 (See above)		
	Insulation Resistance	\geq Initial Value x 0.1 (See Above)		
	Dielectric Strength	Meets Initial Values (As Above)		

MLCC Gold Termination – AU Series

General Specifications

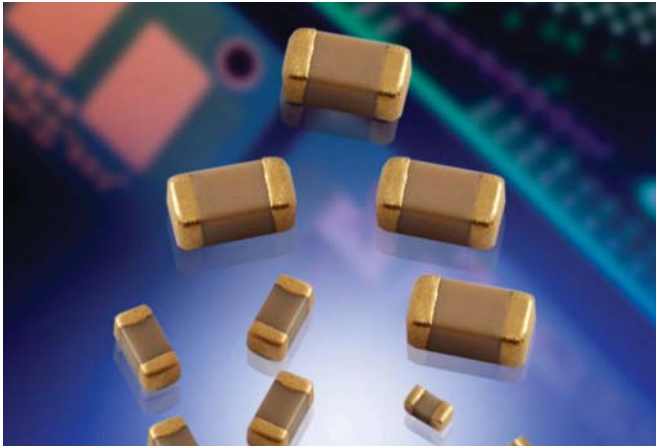

AVX Corporation will support those customers for commercial and military Multilayer Ceramic Capacitors with a termination consisting of Gold. This termination is indicated by the use of a “7” or “G” in the 12th position of the AVX Catalog Part Number. This fulfills AVX’s commitment to providing a full range of products to our customers. Please contact the factory if you require additional information on our MLCC Gold Termination.

PART NUMBER

AU03	Y	C	104	K	A	7	2	A
Size	Voltage	Dielectric	Capacitance Code (In pF)	Capacitance Tolerance	Failure Rate	Terminations	Packaging	Special Code
AU01 - 0201 AU02 - 0402 AU03 - 0603 AU05 - 0805 AU06 - 1206 AU10 - 1210 AU12 - 1812 AU13 - 1825 AU14 - 2225 AU16 - 0306 AU17 - 0508 AU18 - 0612	6.3V = 6 10V = Z 16V = Y 25V = 3 35V = D 50V = 5 100V = 1 200V = 2 500V = 7	COG (NP0) = A X7R = C X5R = D	2 Sig. Digits + Number of Zeros	B = ±.10 pF (<10pF) C = ±.25 pF (<10pF) D = ±.50 pF (<10pF) F = ±1% (≥ 10 pF) G = ±2% (≥ 10 pF) J = ±5% K = ±10% M = ±20%	A = Not Applicable	G* = 1.9 μ" to 7.87 μ" 7 = 100 μ" minimum	2 = 7" Reel 4 = 13" Reel U = 4mm TR (01005) Contact Factory For Multiples*	A = Std. Product

* Contact factory for availability.

MLCC Gold Termination – AU Series

Capacitance Range (NP0 Dielectric)

PREFERRED SIZES ARE SHADED

SIZE		AU10					AU12					AU13			AU14		
Soldering		Reflow/Epoxy/ Wire Bond*					Reflow/Epoxy/ Wire Bond*					Reflow/Epoxy/ Wire Bond*			Reflow/Epoxy/ Wire Bond*		
Packaging		Paper/Embossed					All Embossed					All Embossed			All Embossed		
(L) Length	mm (in.)	3.20 ± 0.20 (0.126 ± 0.008)					4.50 ± 0.30 (0.177 ± 0.012)					4.50 ± 0.30 (0.177 ± 0.012)			5.72 ± 0.25 (0.225 ± 0.010)		
(W) Width	mm (in.)	2.50 ± 0.20 (0.098 ± 0.008)					3.20 ± 0.20 (0.126 ± 0.008)					6.40 ± 0.40 (0.252 ± 0.016)			6.35 ± 0.25 (0.250 ± 0.010)		
(t) Terminal	mm (in.)	0.50 ± 0.25 (0.020 ± 0.010)					0.61 ± 0.36 (0.024 ± 0.014)					0.61 ± 0.36 (0.024 ± 0.014)			0.64 ± 0.39 (0.025 ± 0.015)		
WDC		25	50	100	200	500	25	50	100	200	500	50	100	200	50	100	200
Cap (pF)	0.5																
	1.0																
	1.2																
	1.5																
	1.8																
	2.2																
	2.7																
	3.3																
	3.9																
	4.7																
	5.6																
	6.8																
	8.2																
	10					J											
	12					J											
	15					J											
	18					J											
	22					J											
	27					J											
	33					J											
	39					J											
	47					J											
	56					J											
	68					J											
	82					J											
	100					J											
	120					J											
	150					J											
	180					J											
	220					J											
	270					J											
	330					J											
	390					M											
	470					M											
	560	J	J	J	J	M											
	680	J	J	J	J	M											
	820	J	J	J	J	M											
	1000	J	J	J	J	M	K	K	K	K	M	M	M	M	M	M	P
	1200	J	J	J	M	M	K	K	K	K	M	M	M	M	M	M	P
	1500	J	J	J	M	M	K	K	K	K	M	M	M	M	M	M	P
	1800	J	J	J	M		K	K	K	K	M	M	M	M	M	M	P
	2200	J	J	J	Q		K	K	K	K	P	M	M	M	M	M	P
	2700	J	J	J	Q		K	K	K	P	Q	M	M	M	M	M	P
	3300	J	J	J			K	K	K	P	Q	M	M	M	M	M	P
	3900	J	J	M			K	K	K	P	Q	M	M	M	M	M	P
	4700	J	J	M			K	K	K	P	Q	M	M	M	M	M	P
	5600	J	J				K	K	M	P	X	M	M	M	M	M	P
	6800	J	J				K	K	M	X		M	M	M	M	M	P
	8200	J	J				K	M	M			M	M		M	M	P
Cap (µF)	0.010	J	J				K	M	M			M	M		M	M	P
	0.012	J	J				K	M				M	M		M	M	P
	0.015						M	M				M	M		M	M	Y
	0.018						M	M				P	M		M	M	Y
	0.022						M	M				P			M	Y	Y
	0.027						M	M				P			P	Y	Y
	0.033						M	M				P			P		
	0.039						M	M				P			P		
	0.047						M	M				P			P		
	0.068						M	M							P		
	0.082						M	M							Q		
	0.1														Q		
WDC		25	50	100	200	500	25	50	100	200	500	50	100	200	50	100	200

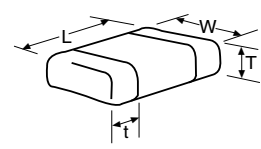

* Contact factory

Letter	A	C	E	G	J	K	M	N	P	Q	X	Y	Z
Max. Thickness	0.33 (0.013)	0.56 (0.022)	0.71 (0.028)	0.90 (0.035)	0.94 (0.037)	1.02 (0.040)	1.27 (0.050)	1.40 (0.055)	1.52 (0.060)	1.78 (0.070)	2.29 (0.090)	2.54 (0.100)	2.79 (0.110)
	PAPER					EMBOSSSED							

MLCC Gold Termination – AU Series

Capacitance Range (X7R Dielectric)

PREFERRED SIZES ARE SHADED

SIZE	AU02			AU03						AU05						AU06										
Soldering	Reflow/Epoxy Wire Bond*			Reflow/Epoxy Wire Bond*						Reflow/Epoxy Wire Bond*						Reflow/Epoxy Wire Bond*										
Packaging	All Paper			All Paper						Paper/Embossed						Paper/Embossed										
(L) Length (mm (in.))	1.00 ± 0.10 (0.040 ± 0.004)			1.60 ± 0.15 (0.063 ± 0.006)						2.01 ± 0.20 (0.079 ± 0.008)						3.20 ± 0.20 (0.126 ± 0.008)										
(W) Width (mm (in.))	0.50 ± 0.10 (0.020 ± 0.004)			0.81 ± 0.15 (0.032 ± 0.006)						1.25 ± 0.20 (0.049 ± 0.008)						1.60 ± 0.20 (0.063 ± 0.008)										
(t) Terminal (mm (in.))	0.25 ± 0.15 (0.010 ± 0.006)			0.35 ± 0.15 (0.014 ± 0.006)						0.50 ± 0.25 (0.020 ± 0.010)						0.50 ± 0.25 (0.020 ± 0.010)										
WVDC	16	25	50	6.3	10	16	25	50	100	200	6.3	10	16	25	50	100	200	6.3	10	16	25	50	100	200	500	
Cap (pF)																										
100																										
150																										
220			C																							
330			C					G	G	G	J	J	J	J	J	J	J								K	
470			C					G	G	G	J	J	J	J	J	J	J								K	
680			C					G	G	G	J	J	J	J	J	J	J								K	
1000			C					G	G	G	J	J	J	J	J	J	J								K	
1500			C					G	G	G	J	J	J	J	J	J	J	J	J	J	J	J	J	J	M	
2200			C					G	G	G	J	J	J	J	J	J	J	J	J	J	J	J	J	J	M	
3300			C	C				G	G	G	J	J	J	J	J	J	J	J	J	J	J	J	J	J	M	
4700			C	C				G	G	G	J	J	J	J	J	J	J	J	J	J	J	J	J	J	M	
6800	C	C	C					G	G	G	J	J	J	J	J	J	J	J	J	J	J	J	J	J	P	
Cap (µF)																										
0.010								G	G	G	J	J	J	J	J	J	J	J	J	J	J	J	J	J	P	
0.015	C	C						G	G	G	J	J	J	J	J	J	J	J	J	J	J	J	J	J	M	
0.022	C	C						G	G	G	J	J	J	J	J	J	N	J	J	J	J	J	J	J	M	
0.033								G	G	G	J	J	J	J	J	N		J	J	J	J	J	J	J	M	
0.047							G	G	G	G	J	J	J	J	J	N		J	J	J	J	J	J	J	M	
0.068							G	G	G	G	J	J	J	J	J	N		J	J	J	J	J	J	J	P	
0.10		C*				G	G	G	G		J	J	J	J	N			J	J	J	J	J	M	P		
0.15					G	G					J	J	J	J	N	N		J	J	J	J	J	Q			
0.22					G	G					J	J	J	N	N	N		J	J	J	J	J	Q			
0.33											N	N	N	N	N	N		J	J	M	P	Q	Q			
0.47						J*					N	N	N	N				M	M	M	P	Q	Q			
0.68						J*	J*				N	N	N	N				M	M	Q	Q	Q	Q			
1.0						J*	J*				N	N	N*					M	M	Q	Q	Q	Q			
1.5																		P	Q	Q	Q					
2.2				J*										P*				Q	Q	Q						
3.3																										
4.7												P*	P*					Q*	Q*	Q*						
10												P*						Q*	Q*							
22																		Q*								
47																										
100																										
WVDC	16	25	50	6.3	10	16	25	50	100	200	6.3	10	16	25	50	100	200	6.3	10	16	25	50	100	200	500	
SIZE	AU02			AU03						AU05						AU06										

* Contact factory

Letter	A	C	E	G	J	K	M	N	P	Q	X	Y	Z
Max. Thickness	0.33 (0.013)	0.56 (0.022)	0.71 (0.028)	0.90 (0.035)	0.94 (0.037)	1.02 (0.040)	1.27 (0.050)	1.40 (0.055)	1.52 (0.060)	1.78 (0.070)	2.29 (0.090)	2.54 (0.100)	2.79 (0.110)
	PAPER					EMBOSSSED							

MLCC Gold Termination – AU Series

Capacitance Range (X7R Dielectric)

PREFERRED SIZES ARE SHADED

SIZE	AU10								AU12				AU13		AU14	
	Reflow/Epoxy/Wire Bond*								Reflow/Epoxy/Wire Bond*				Reflow/Epoxy/Wire Bond*		Reflow/Epoxy/Wire Bond*	
Packaging	Paper/Embossed								All Embossed				All Embossed		All Embossed	
(L) Length	3.20 ± 0.20 (0.126 ± 0.008)								4.50 ± 0.30 (0.177 ± 0.012)				4.50 ± 0.30 (0.177 ± 0.012)		5.72 ± 0.25 (0.225 ± 0.010)	
(W) Width	2.50 ± 0.20 (0.098 ± 0.008)								3.20 ± 0.20 (0.126 ± 0.008)				6.40 ± 0.40 (0.252 ± 0.016)		6.35 ± 0.25 (0.250 ± 0.010)	
(t) Terminal	0.50 ± 0.25 (0.020 ± 0.010)								0.61 ± 0.36 (0.024 ± 0.014)				0.61 ± 0.36 (0.024 ± 0.014)		0.64 ± 0.39 (0.025 ± 0.015)	
WVDC	10	16	25	50	100	200	500	50	100	200	500	50	100	50	100	
Cap (pF)	100															
	150															
	220															
	330															
	470															
	680															
	1000															
	1500	J	J	J	J	J	J	M								
	2200	J	J	J	J	J	J	M								
	3300	J	J	J	J	J	J	M								
	4700	J	J	J	J	J	J	M								
	6800	J	J	J	J	J	J	M								
Cap (µF)	0.010	J	J	J	J	J	J	M	K	K	K	K	M	M	M	P
	0.015	J	J	J	J	J	J	P	K	K	K	P	M	M	M	P
	0.022	J	J	J	J	J	J	Q	K	K	K	P	M	M	M	P
	0.033	J	J	J	J	J	J	Q	K	K	K	X	M	M	M	P
	0.047	J	J	J	J	J	J		K	K	K	Z	M	M	M	P
	0.068	J	J	J	J	J	M		K	K	K	Z	M	M	M	P
	0.10	J	J	J	J	J	M		K	K	K	Z	M	M	M	P
	0.15	J	J	J	J	M	Z		K	K	P		M	M	M	P
	0.22	J	J	J	J	P	Z		K	K	P		M	M	M	P
	0.33	J	J	J	J	Q			K	M	X		M	M	M	P
	0.47	M	M	M	M	Q			K	P			M	M	M	P
	0.68	M	M	P	X	X			M	Q			M	P	M	P
	1.0	N	N	P	X	Z			M	X			M	P	M	P
	1.5	N	N	Z	Z	Z			Z	Z			M		M	X
	2.2	X	X	Z	Z	Z			Z	Z					M	
	3.3	X	X	Z	Z				Z							
	4.7	X	X	Z	Z				Z							
	10	Z	Z	Z												
	22															
	47															
	100															
WVDC	10	16	25	50	100	200	500	50	100	200	500	50	100	50	100	
SIZE	AU10								AU12				AU13		AU14	

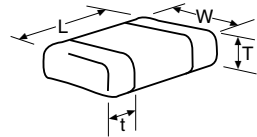

* Contact factory

Letter	A	C	E	G	J	K	M	N	P	Q	X	Y	Z
Max. Thickness	0.33 (0.013)	0.56 (0.022)	0.71 (0.028)	0.90 (0.035)	0.94 (0.037)	1.02 (0.040)	1.27 (0.050)	1.40 (0.055)	1.52 (0.060)	1.78 (0.070)	2.29 (0.090)	2.54 (0.100)	2.79 (0.110)
	PAPER					EMBOSSSED							

MLCC Gold Termination – AU Series

AU16/AU17/AU18

SIZE		AU16 (0306)					AU17 (0508)					AU18 (0612)				
Packaging		Embossed					Embossed					Embossed				
Length		0.81 ± 0.15 (0.032 ± 0.006)					1.27 ± 0.25 (0.050 ± 0.010)					1.60 ± 0.25 (0.063 ± 0.010)				
Width		1.60 ± 0.15 (0.063 ± 0.006)					2.00 ± 0.25 (0.080 ± 0.010)					3.20 ± 0.25 (0.126 ± 0.010)				
Cap Code	WDC	4	6.3	10	16	25	6.3	10	16	25	50	6.3	10	16	25	50
102	Cap 0.001		A	A	A	A	S	S	S	S	V	S	S	S	S	V
222	(µF) 0.0022		A	A	A	A	S	S	S	S	V	S	S	S	S	V
332	0.0033		A	A	A	A	S	S	S	S	V	S	S	S	S	V
472	0.0047		A	A	A	A	S	S	S	S	V	S	S	S	S	V
682	0.0068		A	A	A	A	S	S	S	S	V	S	S	S	S	V
103	0.01		A	A	A	A	S	S	S	S	V	S	S	S	S	V
153	0.015		A	A	A	A	S	S	S	S	V	S	S	S	S	W
223	0.022		A	A	A	A	S	S	S	S	V	S	S	S	S	W
333	0.033		A	A	A		S	S	S	V	V	S	S	S	S	W
473	0.047		A	A	A		S	S	S	V	A	S	S	S	S	W
683	0.068		A	A	A		S	S	S	A	A	S	S	S	V	W
104	0.1		A	A	A		S	S	V	A	A	S	S	S	V	W
154	0.15		A	A			S	S	V			S	S	S	W	W
224	0.22		A	A			S	S	A			S	S	V	W	
334	0.33						V	V	A			S	S	V	W	
474	0.47						V	V	A			S	S	V		
684	0.68						A	A				V	V	W		
105	1	A					A	A				V	V	A		
155	1.5											W	W			
225	2.2											A	A			
335	3.3															
475	4.7															
685	6.8															
106	10															

PHYSICAL DIMENSIONS AND PAD LAYOUT

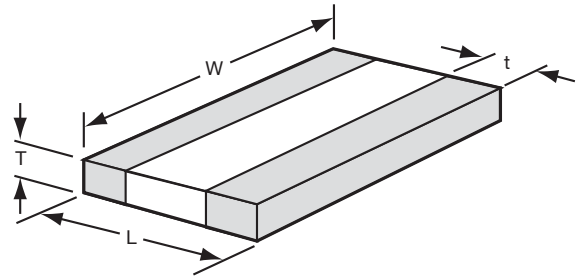

PHYSICAL DIMENSIONS

mm (in)

	L	W	t
AU16 (0306)	0.81 ± 0.15 (0.032 ± 0.006)	1.60 ± 0.15 (0.063 ± 0.006)	0.13 min. (0.005 min.)
AU17 (0508)	1.27 ± 0.25 (0.050 ± 0.010)	2.00 ± 0.25 (0.080 ± 0.010)	0.13 min. (0.005 min.)
AU18 (0612)	1.60 ± 0.25 (0.063 ± 0.010)	3.20 ± 0.25 (0.126 ± 0.010)	0.13 min. (0.005 min.)

T - See Range Chart for Thickness and Codes

PAD LAYOUT DIMENSIONS

mm (in)

	A	B	C
AU16 (0306)	0.31 (0.012)	1.52 (0.060)	0.51 (0.020)
AU17 (0508)	0.51 (0.020)	2.03 (0.080)	0.51 (0.020)
AU18 (0612)	0.76 (0.030)	3.05 (0.120)	0.635 (0.025)

Solid = X7R

= X5R

= X7S

mm (in.)	
AU16 (0306)	
Code	Thickness
A	0.56 (0.022)

mm (in.)	
AU17 (0508)	
Code	Thickness
S	0.56 (0.022)
V	0.76 (0.030)
A	1.02 (0.040)

mm (in.)	
AU18 (0612)	
Code	Thickness
S	0.56 (0.022)
V	0.76 (0.030)
W	1.02 (0.040)
A	1.27 (0.050)

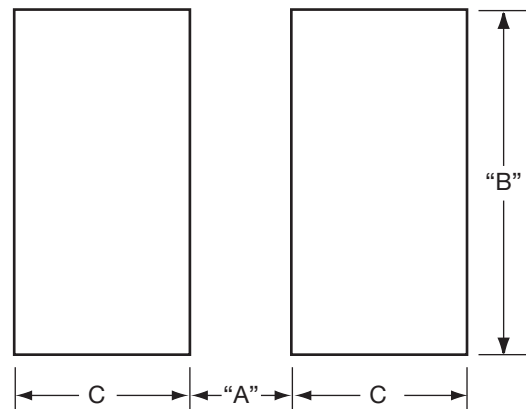

MLCC Tin/Lead Termination “B”

General Specifications

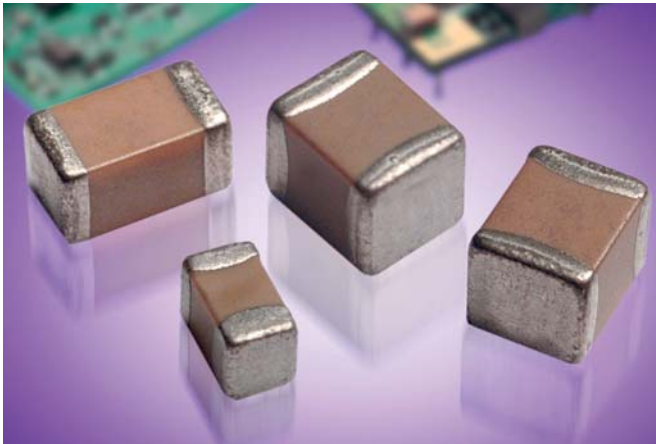

AVX Corporation will support those customers for commercial and military Multilayer Ceramic Capacitors with a termination consisting of 5% minimum lead. This termination is indicated by the use of a “B” in the 12th position of the AVX Catalog Part Number. This fulfills AVX’s commitment to providing a full range of products to our customers. AVX has provided in the following pages a full range of values that we are currently offering in this special “B” termination. Please contact the factory if you require additional information on our MLCC Tin/Lead Termination “B” products.

Not RoHS Compliant

PART NUMBER (see page 2 for complete part number explanation)

LD05	5	A	101	J	A	B	2	A
Size	Voltage	Dielectric	Capacitance Code (In pF)	Capacitance Tolerance	Failure Rate	Terminations	Packaging	Special Code
LD02 - 0402 LD03 - 0603 LD04 - 0504* LD05 - 0805 LD06 - 1206 LD10 - 1210 LD12 - 1812 LD13 - 1825 LD14 - 2225 LD20 - 2220	6.3V = 6 10V = Z 16V = Y 25V = 3 35V = D 50V = 5 100V = 1 200V = 2 500V = 7	COG (NP0) = A X7R = C X5R = D X8R = F	2 Sig. Digits + Number of Zeros	B = ±.10 pF (<10pF) C = ±.25 pF (<10pF) D = ±.50 pF (<10pF) F = ±1% (≥ 10 pF) G = ±2% (≥ 10 pF) J = ±5% K = ±10% M = ±20%	A = Not Applicable	B = 5% min lead X = FLEXITERM® with 5% min lead**	2 = 7" Reel 4 = 13" Reel	A = Std. Product
						**X7R only	Contact Factory For Multiples	

*LD04 has the same CV ranges as LD03.

NOTE: Contact factory for availability of Tolerance Options for Specific Part Numbers.
Contact factory for non-specified capacitance values.

See FLEXITERM® section
for CV options

NP0	Refer to page 4 for Electrical Graphs
X7R	Refer to page 19 for Electrical Graphs
X7S	Refer to page 23 for Electrical Graphs
X5R	Refer to page 26 for Electrical Graphs
Y5V	Refer to page 30 for Electrical Graphs

MLCC Tin/Lead Termination "B"

Capacitance Range (NP0 Dielectric)

PREFERRED SIZES ARE SHADED

SIZE	LD02			LD03				LD05					LD06						
Soldering	Reflow/Wave			Reflow/Wave				Reflow/Wave					Reflow/Wave						
Packaging	All Paper			All Paper				Paper/Embossed					Paper/Embossed						
(L) Length	mm (in.)			mm (in.)				mm (in.)					mm (in.)						
(W) Width	mm (in.)			mm (in.)				mm (in.)					mm (in.)						
(t) Terminal	mm (in.)			mm (in.)				mm (in.)					mm (in.)						
WVDC	16	25	50	16	25	50	100	16	25	50	100	200	16	25	50	100	200	500	
Cap (pF)	0.5	C	C	C	G	G	G	G	J	J	J	J	J	J	J	J	J	J	J
	1.0	C	C	C	G	G	G	G	J	J	J	J	J	J	J	J	J	J	J
	1.2	C	C	C	G	G	G	G	J	J	J	J	J	J	J	J	J	J	J
	1.5	C	C	C	G	G	G	G	J	J	J	J	J	J	J	J	J	J	J
	1.8	C	C	C	G	G	G	G	J	J	J	J	J	J	J	J	J	J	J
	2.2	C	C	C	G	G	G	G	J	J	J	J	J	J	J	J	J	J	J
	2.7	C	C	C	G	G	G	G	J	J	J	J	J	J	J	J	J	J	J
	3.3	C	C	C	G	G	G	G	J	J	J	J	J	J	J	J	J	J	J
	3.9	C	C	C	G	G	G	G	J	J	J	J	J	J	J	J	J	J	J
	4.7	C	C	C	G	G	G	G	J	J	J	J	J	J	J	J	J	J	J
	5.6	C	C	C	G	G	G	G	J	J	J	J	J	J	J	J	J	J	J
	6.8	C	C	C	G	G	G	G	J	J	J	J	J	J	J	J	J	J	J
	8.2	C	C	C	G	G	G	G	J	J	J	J	J	J	J	J	J	J	J
	10	C	C	C	G	G	G	G	J	J	J	J	J	J	J	J	J	J	J
	12	C	C	C	G	G	G	G	J	J	J	J	J	J	J	J	J	J	J
	15	C	C	C	G	G	G	G	J	J	J	J	J	J	J	J	J	J	J
	18	C	C	C	G	G	G	G	J	J	J	J	J	J	J	J	J	J	J
	22	C	C	C	G	G	G	G	J	J	J	J	J	J	J	J	J	J	J
	27	C	C	C	G	G	G	G	J	J	J	J	J	J	J	J	J	J	J
	33	C	C	C	G	G	G	G	J	J	J	J	J	J	J	J	J	J	J
	39	C	C	C	G	G	G	G	J	J	J	J	J	J	J	J	J	J	J
	47	C	C	C	G	G	G	G	J	J	J	J	J	J	J	J	J	J	J
	56	C	C	C	G	G	G	G	J	J	J	J	J	J	J	J	J	J	J
	68	C	C	C	G	G	G	G	J	J	J	J	J	J	J	J	J	J	J
	82	C	C	C	G	G	G	G	J	J	J	J	J	J	J	J	J	J	J
	100	C	C	C	G	G	G	G	J	J	J	J	J	J	J	J	J	J	J
	120	C	C	C	G	G	G	G	J	J	J	J	J	J	J	J	J	J	J
	150	C	C	C	G	G	G	G	J	J	J	J	J	J	J	J	J	J	J
	180	C	C	C	G	G	G	G	J	J	J	J	J	J	J	J	J	J	J
	220	C	C	C	G	G	G	G	J	J	J	J	J	J	J	J	J	J	M
	270	C	C	C	G	G	G	G	J	J	J	J	M	J	J	J	J	J	M
	330	C	C	C	G	G	G	G	J	J	J	J	M	J	J	J	J	J	M
	390	C	C	C	G	G	G	G	J	J	J	J	M	J	J	J	J	J	M
	470	C	C	C	G	G	G	G	J	J	J	J	M	J	J	J	J	J	M
	560				G	G	G	G	J	J	J	J	M	J	J	J	J	J	M
	680				G	G	G	G	J	J	J	J		J	J	J	J	J	P
	820				G	G	G	G	J	J	J	J		J	J	J	J	M	
	1000				G	G	G		J	J	J	J		J	J	J	J	Q	Q
	1200					G			J	J	J			J	J	J	J	Q	Q
	1500								J	J	J			J	J	M		Q	
	1800								J	J	J			J	J	M		M	
	2200								J	J	N			J	J	M		P	
	2700								J	J	N			J	J	M		P	
	3300								J	J				J	J	M		P	
	3900								J	J				J	J	M		P	
	4700								J	J				J	J	M		P	
	5600													J	J	M			
	6800													M	M				
	8200													M	M				
Cap (µF)	0.010													M	M				
	0.012																		
	0.015																		
	0.018																		
	0.022																		
	0.027																		
	0.033																		
	0.039																		
	0.047																		
	0.068																		
	0.082																		
	0.1																		
WVDC	16	25	50	16	25	50	100	16	25	50	100	200	16	25	50	100	200	500	
SIZE	LD02			LD03				LD05					LD06						

Letter	A	C	E	G	J	K	M	N	P	Q	X	Y	Z
Max. Thickness	0.33 (0.013)	0.56 (0.022)	0.71 (0.028)	0.90 (0.035)	0.94 (0.037)	1.02 (0.040)	1.27 (0.050)	1.40 (0.055)	1.52 (0.060)	1.78 (0.070)	2.29 (0.090)	2.54 (0.100)	2.79 (0.110)
	PAPER					EMBOSSSED							

MLCC Tin/Lead Termination "B"

Capacitance Range (NP0 Dielectric)

PREFERRED SIZES ARE SHADED

SIZE		LD10					LD12					LD13			LD14		
Soldering		Reflow Only					Reflow Only					Reflow Only			Reflow Only		
Packaging		Paper/Embossed					All Embossed					All Embossed			All Embossed		
(L) Length	mm	3.20 ± 0.20 (0.126 ± 0.008)					4.50 ± 0.30 (0.177 ± 0.012)					4.50 ± 0.30 (0.177 ± 0.012)			5.72 ± 0.25 (0.225 ± 0.010)		
(W) Width	mm	2.50 ± 0.20 (0.098 ± 0.008)					3.20 ± 0.20 (0.126 ± 0.008)					6.40 ± 0.40 (0.252 ± 0.016)			6.35 ± 0.25 (0.250 ± 0.010)		
(t) Terminal	mm	0.50 ± 0.25 (0.020 ± 0.010)					0.61 ± 0.36 (0.024 ± 0.014)					0.61 ± 0.36 (0.024 ± 0.014)			0.64 ± 0.39 (0.025 ± 0.015)		
WVDC		25	50	100	200	500	25	50	100	200	500	50	100	200	50	100	200
Cap (pF)	0.5																
	1.0																
	1.2																
	1.5																
	1.8																
	2.2																
	2.7																
	3.3																
	3.9																
	4.7																
	5.6																
	6.8																
	8.2																
	10					J											
	12					J											
	15					J											
	18					J											
	22					J											
	27					J											
	33					J											
	39					J											
	47					J											
	56					J											
	68					J											
	82					J											
	100					J											
	120					J											
	150					J											
	180					J											
	220					J											
	270					J											
	330					J											
	390					M											
	470					M											
	560	J	J	J	J	M											
	680	J	J	J	J	M											
	820	J	J	J	J	M											
	1000	J	J	J	J	M	K	K	K	K	M	M	M	M	M	M	P
	1200	J	J	J	M	M	K	K	K	K	M	M	M	M	M	M	P
	1500	J	J	J	M	M	K	K	K	K	M	M	M	M	M	M	P
	1800	J	J	J	M		K	K	K	K	M	M	M	M	M	M	P
	2200	J	J	J	Q		K	K	K	K	P	M	M	M	M	M	P
	2700	J	J	J	Q		K	K	K	P	Q	M	M	M	M	M	P
	3300	J	J	J			K	K	K	P	Q	M	M	M	M	M	P
	3900	J	J	M			K	K	K	P	Q	M	M	M	M	M	P
	4700	J	J	M			K	K	K	P	Q	M	M	M	M	M	P
	5600	J	J				K	K	M	P	X	M	M	M	M	M	P
	6800	J	J				K	K	M	X		M	M	M	M	M	P
	8200	J	J				K	M	M			M	M		M	M	P
Cap (µF)	0.010	J	J				K	M	M			M	M		M	M	P
	0.012	J	J				K	M				M	M		M	M	P
	0.015						M	M				M	M		M	M	Y
	0.018						M	M				P	M		M	M	Y
	0.022						M	M				P			M	Y	Y
	0.027						M	M				P			P	Y	Y
	0.033						M	M				P			P		
	0.039						M	M				P			P		
	0.047						M	M				P			P		
	0.068						M	M							P		
	0.082						M	M							Q		
	0.1														Q		
WVDC		25	50	100	200	500	25	50	100	200	500	50	100	200	50	100	200

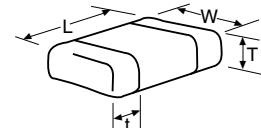

Letter	A	C	E	G	J	K	M	N	P	Q	X	Y	Z
Max. Thickness	0.33 (0.013)	0.56 (0.022)	0.71 (0.028)	0.90 (0.035)	0.94 (0.037)	1.02 (0.040)	1.27 (0.050)	1.40 (0.055)	1.52 (0.060)	1.78 (0.070)	2.29 (0.090)	2.54 (0.100)	2.79 (0.110)
	PAPER					EMBOSSED							

MLCC Tin/Lead Termination “B”

Capacitance Range (X8R Dielectric)

SIZE		LD03		LD05		LD06	
	WVDC	25V	50V	25V	50V	25V	50V
271	Cap 270	G	G				
331	(pF) 330	G	G	J	J		
471	470	G	G	J	J		
681	680	G	G	J	J		
102	1000	G	G	J	J	J	J
152	1500	G	G	J	J	J	J
182	1800	G	G	J	J	J	J
222	2200	G	G	J	J	J	J
272	2700	G	G	J	J	J	J
332	3300	G	G	J	J	J	J
392	3900	G	G	J	J	J	J
472	4700	G	G	J	J	J	J
562	5600	G	G	J	J	J	J
682	6800	G	G	J	J	J	J
822	8200	G	G	J	J	J	J
103	Cap 0.01	G	G	J	J	J	J
123	(µF) 0.012	G	G	J	J	J	J
153	0.015	G	G	J	J	J	J
183	0.018	G	G	J	J	J	J
223	0.022	G	G	J	J	J	J
273	0.027	G	G	J	J	J	J
333	0.033	G	G	J	J	J	J
393	0.039	G	G	J	J	J	J
473	0.047	G	G	J	J	J	J
563	0.056	G		N	N	M	M
683	0.068	G		N	N	M	M
823	0.082			N	N	M	M
104	0.1			N	N	M	M
124	0.12			N	N	M	M
154	0.15			N	N	M	M
184	0.18			N		M	M
224	0.22			N		M	M
274	0.27					M	M
334	0.33					M	M
394	0.39					M	
474	0.47					M	
684	0.68						
824	0.82						
105	1						
SIZE	WVDC	25V	50V	25V	50V	25V	50V
		LD03		LD05		LD06	

Letter	A	C	E	G	J	K	M	N	P	Q	X	Y	Z
Max. Thickness	0.33 (0.013)	0.56 (0.022)	0.71 (0.028)	0.90 (0.035)	0.94 (0.037)	1.02 (0.040)	1.27 (0.050)	1.40 (0.055)	1.52 (0.060)	1.78 (0.070)	2.29 (0.090)	2.54 (0.100)	2.79 (0.110)
	PAPER					EMBOSSSED							

MLCC Tin/Lead Termination “B”

Capacitance Range (X7R Dielectric)

PREFERRED SIZES ARE SHADED

SIZE	LD02			LD03						LD05						LD06									
Soldering	Reflow/Wave			Reflow/Wave						Reflow/Wave						Reflow/Wave									
Packaging	All Paper			All Paper						Paper/Embossed						Paper/Embossed									
(L) Length	mm	1.00 ± 0.10		1.60 ± 0.15						2.01 ± 0.20						3.20 ± 0.20									
(W) Width	mm	0.50 ± 0.10		0.81 ± 0.15						1.25 ± 0.20						1.60 ± 0.20									
(t) Terminal	mm	0.25 ± 0.15		0.35 ± 0.15						0.50 ± 0.25						0.50 ± 0.25									
	(in.)	(0.010 ± 0.006)		(0.014 ± 0.006)						(0.020 ± 0.010)						(0.020 ± 0.010)									
WDC	16	25	50	6.3	10	16	25	50	100	200	6.3	10	16	25	50	100	200	6.3	10	16	25	50	100	200	500
Cap (pF)	100																								
	150																								
	220		C																						
	330							G	G	G			J	J	J	J	J								K
	470		C					G	G	G			J	J	J	J	J								K
	680		C					G	G	G			J	J	J	J	J								K
	1000		C					G	G	G			J	J	J	J	J								K
	1500		C					G	G	G			J	J	J	J	J		J	J	J	J	J	J	M
	2200		C					G	G	G			J	J	J	J	J		J	J	J	J	J	J	M
	3300		C	C				G	G	G			J	J	J	J	J		J	J	J	J	J	J	M
	4700		C	C				G	G	G			J	J	J	J	J		J	J	J	J	J	J	M
	6800	G	C	C				G	G	G			J	J	J	J	J		J	J	J	J	J	J	P
Cap (µF)	0.010	C	C					G	G	G			J	J	J	J	J		J	J	J	J	J	J	P
	0.015	C						G	G	G			J	J	J	J	J		J	J	J	J	J	J	M
	0.022	C						G	G	G			J	J	J	J	J		J	J	J	J	J	J	M
	0.033	C						G	G	G			J	J	J	J	N		J	J	J	J	J	J	M
	0.047							G	G	G			J	J	J	J	N		J	J	J	J	J	J	M
	0.068							G	G	G			J	J	J	J	N		J	J	J	J	J	J	P
	0.10		C*					G	G	G			J	J	J	J	N		J	J	J	J	J	J	P
	0.15							G	G	G			J	J	J	J	N		J	J	J	J	J	J	P
	0.22							G	G	G			J	J	N	N	N		J	J	J	J	J	J	Q
	0.33												N	N	N	N	N		J	J	M	P	Q	Q	
	0.47							J*					N	N	N	N	N		M	M	M	P	Q	Q	
	0.68							J*	J*				N	N	N				M	M	Q	Q	Q	Q	
	1.0												N	N	N*				M	M	Q	Q	Q	Q	
	1.5																		P	Q	Q	Q			
	2.2							J*											Q	Q	Q				
	3.3																		Q	Q	Q				
	4.7																		Q*	Q*	Q*				
	10																		P*	P					
	22																								Q*
	47																								
	100																								
WDC	16	25	50	6.3	10	16	25	50	100	200	6.3	10	16	25	50	100	200	6.3	10	16	25	50	100	200	500
SIZE	LD02			LD03						LD05						LD06									

Letter	A	C	E	G	J	K	M	N	P	Q	X	Y	Z
Max.	0.33	0.56	0.71	0.90	0.94	1.02	1.27	1.40	1.52	1.78	2.29	2.54	2.79
Thickness	(0.013)	(0.022)	(0.028)	(0.035)	(0.037)	(0.040)	(0.050)	(0.055)	(0.060)	(0.070)	(0.090)	(0.100)	(0.110)
	PAPER					EMBOSSSED							

 = Under Development

MLCC Tin/Lead Termination “B”

Capacitance Range (X7R Dielectric)

PREFERRED SIZES ARE SHADED

SIZE		LD10							LD12				LD13		LD20				LD14	
Soldering		Reflow Only							Reflow Only				Reflow Only		Reflow Only				Reflow Only	
Packaging		Paper/Embossed							All Embossed				All Embossed		All Embossed				All Embossed	
(L) Length	mm (in.)	3.20 ± 0.20 (0.126 ± 0.008)							4.50 ± 0.30 (0.177 ± 0.012)				4.50 ± 0.30 (0.177 ± 0.012)		5.70 ± 0.40 (0.225 ± 0.016)				5.72 ± 0.25 (0.225 ± 0.010)	
(W) Width	mm (in.)	2.50 ± 0.20 (0.098 ± 0.008)							3.20 ± 0.20 (0.126 ± 0.008)				6.40 ± 0.40 (0.252 ± 0.016)		5.00 ± 0.40 (0.197 ± 0.016)				6.35 ± 0.25 (0.250 ± 0.010)	
(t) Terminal	mm (in.)	0.50 ± 0.25 (0.020 ± 0.010)							0.61 ± 0.36 (0.024 ± 0.014)				0.61 ± 0.36 (0.024 ± 0.014)		0.64 ± 0.39 (0.025 ± 0.015)				0.64 ± 0.39 (0.025 ± 0.015)	
WVDC		10	16	25	50	100	200	500	50	100	200	500	50	100	25	50	100	200	50	100
Cap (pF)	100																			
	150																			
	220																			
	330																			
	470																			
	680																			
	1000	J	J	J	J	J	J	M												
	1500	J	J	J	J	J	J	M												
	2200	J	J	J	J	J	J	M												
	3300	J	J	J	J	J	J	M												
	4700	J	J	J	J	J	J	M												
	6800	J	J	J	J	J	J	M												
Cap (µF)	0.010	J	J	J	J	J	J	M	K	K	K	K	M	M		X	X	X	M	P
	0.015	J	J	J	J	J	J	P	K	K	K	P	M	M		X	X	X	M	P
	0.022	J	J	J	J	J	J	Q	K	K	K	P	M	M		X	X	X	M	P
	0.033	J	J	J	J	J	J	Q	K	K	K	X	M	M		X	X	X	M	P
	0.047	J	J	J	J	J	J		K	K	K	Z	M	M		X	X	X	M	P
	0.068	J	J	J	J	J	M		K	K	K	Z	M	M		X	X	X	M	P
	0.10	J	J	J	J	J	M		K	K	K	Z	M	M		X	X	X	M	P
	0.15	J	J	J	J	M	Z		K	K	P		M	M		X	X	X	M	P
	0.22	J	J	J	J	P	Z		K	K	P		M	M		X	X	X	M	P
	0.33	J	J	J	J	Q			K	M	X		M	M		X	X	X	M	P
	0.47	M	M	M	M	Q			K	P			M	M		X	X	X	M	P
	0.68	M	M	P	X	X			M	Q			M	P		X	X		M	P
	1.0	N	N	P	X	Z			M	X			M	P		X	X		M	P
	1.5	N	N	Z	Z	Z			Z	Z			M			X	X		M	X
	2.2	X	X	Z	Z	Z			Z	Z						X	X		M	
	3.3	X	X	Z	Z				Z							X	Z			
	4.7	X	X	Z	Z				Z							X	Z			
	10	Z	Z	Z	Z											Z	Z			
	22	Z	Z												Z					
	47																			
	100																			
WVDC		10	16	25	50	100	200	500	50	100	200	500	50	100	25	50	100	200	50	100
SIZE		LD10							LD12				LD13		LD20				LD14	

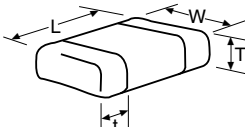

Letter	A	C	E	G	J	K	M	N	P	Q	X	Y	Z
Max. Thickness	0.33 (0.013)	0.56 (0.022)	0.71 (0.028)	0.90 (0.035)	0.94 (0.037)	1.02 (0.040)	1.27 (0.050)	1.40 (0.055)	1.52 (0.060)	1.78 (0.070)	2.29 (0.090)	2.54 (0.100)	2.79 (0.110)
	PAPER					EMBOSSSED							

MLCC Tin/Lead Termination “B”

Capacitance Range (X5R Dielectric)

PREFERRED SIZES ARE SHADED

SIZE	LD02	LD03	LD05	LD06	LD10	LD12	
Soldering	Reflow/Wave	Reflow/Wave	Reflow/Wave	Reflow/Wave	Reflow/Wave		
Packaging	All Paper	All Paper	Paper/Embossed	Paper/Embossed	Paper/Embossed		
(L) Length	mm (in.)	1.60 ± 0.15 (0.063 ± 0.006)	2.01 ± 0.20 (0.079 ± 0.008)	3.20 ± 0.20 (0.126 ± 0.008)	3.20 ± 0.20 (0.126 ± 0.008)		
(W) Width	mm (in.)	0.50 ± 0.10 (0.020 ± 0.004)	0.81 ± 0.15 (0.032 ± 0.006)	1.25 ± 0.20 (0.049 ± 0.008)	1.60 ± 0.20 (0.063 ± 0.008)		
(t) Terminal	mm (in.)	0.25 ± 0.15 (0.010 ± 0.006)	0.35 ± 0.15 (0.014 ± 0.006)	0.50 ± 0.25 (0.020 ± 0.010)	0.50 ± 0.25 (0.020 ± 0.010)		
WVDC	4 6.3 10 16 25 50	4 6.3 10 16 25 35 50	6.3 10 16 25 35 50	6.3 10 16 25 35 50	4 6.3 10 16 25 35 50	6.3 10 25 50	
Cap (pF)	100 150 220	C					
	330 470 680	C C C					
	1000 1500 2200	C C C					
	3300 4700 6800	C	G G				
Cap (µF)	0.010 0.015 0.022	C C C	G G G G	N			
	0.033 0.047 0.068	C C C	G G G G	N N N			
	0.10 0.15 0.22	C C C	G G G	N N N N	Q		
	0.33 0.47 0.68	C* C* C*	G G G	N N N N	Q Q	X	
	1.0 1.5 2.2	C* C* C*	G G G J*	N N P*	Q Q	X X X	
	3.3 4.7 10		G* J* J* J* K*	N N N N* N*	Q Q	Z X	
	22 47 100			P* P* P	X X X X X	Z Z Z Z Z	Z
WVDC	4 6.3 10 16 25 50	4 6.3 10 16 25 35 50	6.3 10 16 25 35 50	6.3 10 16 25 35 50	4 6.3 10 16 25 35 50	6.3 10 25 50	
SIZE	LD02	LD03	LD05	LD06	LD10	LD12	

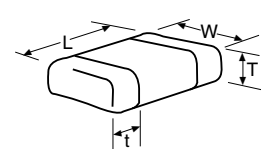

Letter	A	C	E	G	J	K	M	N	P	Q	X	Y	Z
Max. Thickness	0.33 (0.013)	0.56 (0.022)	0.71 (0.028)	0.90 (0.035)	0.94 (0.037)	1.02 (0.040)	1.27 (0.050)	1.40 (0.055)	1.52 (0.060)	1.78 (0.070)	2.29 (0.090)	2.54 (0.100)	2.79 (0.110)
	PAPER					EMBOSSSED							

***Optional Specifications – Contact factory**

NOTE: Contact factory for non-specified capacitance values

MLCC Low Profile

General Specifications

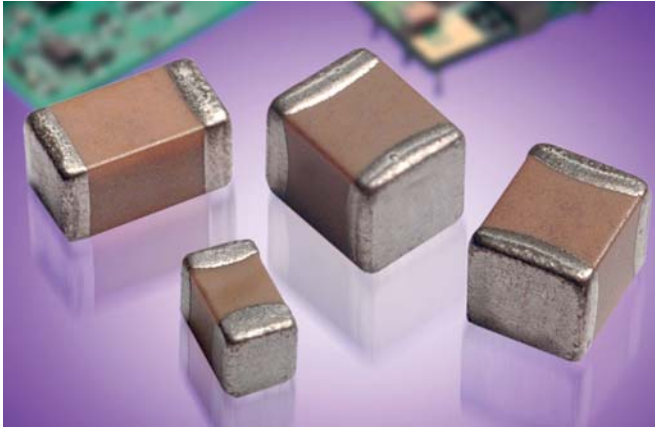

GENERAL DESCRIPTION

AVX introduces the LT series comprising a range of low profile products in our X5R and X7R dielectric. X5R is a Class II dielectric with temperature variation of capacitance within $\pm 15\%$ from -55°C to $+85^{\circ}\text{C}$. Offerings include 0201, 0402, 0603, 0805, 1206, and 1210 packages in compact, low profile designs. The LT series is ideal for decoupling and filtering applications where height clearance is limited.

AVX is also expanding the low profile products in our X7R dielectric. X7R is a Class II dielectric with temperature variation of capacitance within $\pm 15\%$ from -55°C to $+125^{\circ}\text{C}$. Please contact the factory for availability of any additional values not listed.

PART NUMBER (see page 2 for complete part number explanation)

LT05	Z	D	475	K	A	T	2	S
Size	Voltage	Dielectric	Capacitance Code (In pF)	Capacitance Tolerance	Failure Rate	Terminations	Packaging	Special Code
LT01 - 0201 LT02 - 0402 LT03 - 0603 LT05 - 0805 LT06 - 1206 LT10 - 1210	4V = 4 6.3V = 6 10V = Z 16V = Y 25V = 3	X5R = D X7R = C	2 Sig. Digits + Number of Zeros	K = $\pm 10\%$ M = $\pm 20\%$	A = Not Applicable	T = Plated Ni and Sn	2 = 7" Reel 4 = 13" Reel	See table below
							Contact Factory For Multiples	

NOTE: Contact factory for availability of tolerance options for specific part numbers.

SIZE	LT01		LT02				LT03				LT05				LT06					LT10			
	WDC	4	6.3	4	6.3	10	16	4	6.3	16	25	6.3	10	16	25	6.3	10	16	25	50	16	25	
Cap (µF)	0.10	Z	Z		Q		S																
	0.22										X												
	0.47										X											X	
	1.0	Q		C		S				S	X			X	X			X	X	X	W		
	1.5																						
	2.2			S	C				S	X			X	X				X	X	X	X		
	4.7			C				S	X				X	S	X			W	W	X	X	W	
	10												X	X			W	W	W	X		W	
	22																						
	47																						
WDC	4	6.3	4	6.3	10	16	4	6.3	16	25	6.3	10	16	25	6.3	10	16	25	50	16	25		
SIZE	LT01	LT02				LT03				LT05				LT06					LT10				

 = X7R

Letter	J	Z	Q	C	S	X	W
Max. Thickness	0.15 (0.006)	0.22 (0.009)	0.25 (0.010)	0.36 (0.014)	0.56 (0.022)	0.95 (0.038)	1.02 (0.040)
	PAPER						EMBOSSED

UltraThin Ceramic Capacitors

UT Series

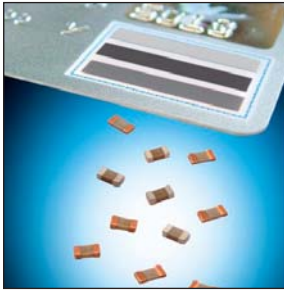

The Ultrathin (UT) series of ceramic capacitors is a new product offering from AVX. The UT series was designed to meet the stringent thickness requirements of our customers. AVX developed a new termination process (FCT - Fine Copper Termination) that provides unbeatable flatness and repeatability. The series includes products < 0.35mm in height and is targeted for applications such as Smart cards, Memory modules, High Density SIM cards, Mobile phones, MP3 players, and embedded solutions.

HOW TO ORDER

UT	02	3	D	103	M	A	T	2	D
Style Ultra Thin	Case Size 0402	Rated Voltage 6 = 6.3V Z = 10V Y = 16V 3 = 25V 5 = 50V	Temperature Characteristic D = X5R C = X7R	Coded Cap (in pF) 2 Significant Digits + Number of Zeros	Cap Tolerance ± 20%	Termination Style Commercial	Termination T = 100% Sn C = Cu G = Au	Packaging 2 = 7" Reel 15,000 pcs 4 = 13" Reel 50,000 pcs	Thickness D = 0.30mm max E = 0.25mm max F = 0.15mm max (only available in Cu Termination)

RECOMMENDED SOLDER PAD DIMENSIONS (Sn Termination)

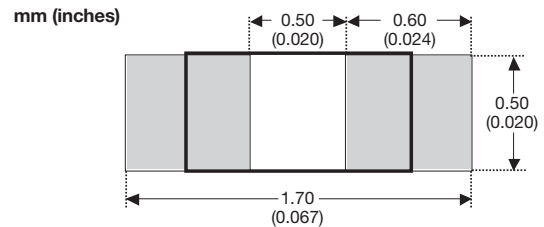
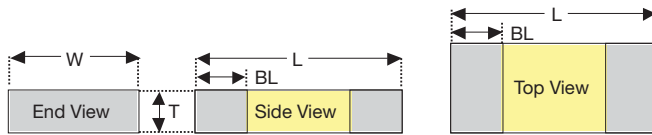

TYPICAL Cu THICKNESS

	TT
μM	10.0 ± 4.00
mil	0.40 ± 0.16



PART DIMENSIONS

mm (inches)

Thickness	L	W	T	BL
D	1.00 ± 0.10 (0.039 ± 0.004)	0.50 ± 0.10 (0.020 ± 0.004)	0.25 ± 0.05 (0.010 ± 0.002)	0.27 ± 0.05 (0.0108 ± 0.002)
E	1.00 ± 0.10 (0.039 ± 0.004)	0.50 ± 0.10 (0.020 ± 0.004)	0.20 ± 0.05 (0.008 ± 0.002)	0.27 ± 0.05 (0.0108 ± 0.002)
F	1.00 ± 0.10 (0.039 ± 0.004)	0.50 ± 0.10 (0.020 ± 0.004)	0.125 ± 0.025 (0.005 ± 0.001)	0.27 ± 0.05 (0.0108 ± 0.002)

CAP RANGE (THICKNESS CODE)

X5R	Thickness Code									
	D					F				
Cap (nF)	6.3V	10V	16V	25V	50V	6.3V	10V	16V	6.3V	10V
1										
10										
22										
33										
47										
68										
100										

X7R	Thickness Code				
	D				
Cap (nF)	6.3V	10V	16V	25V	6.3V
1					
10					

UltraThin Ceramic Capacitors

UT Series Specifications and Test Methods – Cu Termination

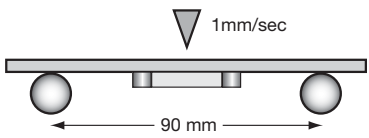
Parameter/Test		Specification Limits	Measuring Conditions
Operating Temperature Range		-55°C to +85°C	Temperature Cycle Chamber
Capacitance		Within specified tolerance	Freq.: 1.0 kHz ± 10%
Dissipation Factor		≤ 3.0% for ≥ 25V DC rating ≤ 12.5% for ≤ 16V DC rating	Voltage: 1.0Vrms ± .2V
Insulation Resistance		100 MΩ - μF	Charge device with rated voltage for 120 ± 5 secs @ room temp/humidity
Dielectric Strength		No breakdown or visual defects	Charge device with 300% of rated voltage for 1-5 seconds, with charge and discharge current limited to 50 mA (max)
Resistance to Flexure Stresses	Appearance	No defects	Deflection: 2mm Test Time: 30 seconds 
	Capacitance Variation	≤ ±12%	
	Dissipation Factor	Meets Initial Values (As Above)	
	Insulation Resistance	≥ Initial Value x 0.3	
Load Life	Appearance	No visual defects	Charge device with 1.5X rated voltage in test chamber set at 85°C ± 2°C for 1000 hours (+48, -0) Remove from test chamber and stabilize at room temperature for 24 ± 2 hours before measuring.
	Capacitance Variation	≤ ±20%	
	Dissipation Factor	≤ Initial Value x 2.0 (As Above)	
	Insulation Resistance	≥ Initial Value x 0.3 (As Above)	
	Dielectric Strength	Meets Initial Values (As Above)	

UltraThin Ceramic Capacitors

UT Series Specifications and Test Methods – Sn Termination

Parameter/Test		Specification Limits	Measuring Conditions
Operating Temperature Range		-55°C to +85°C	Temperature Cycle Chamber
Capacitance		Within specified tolerance	Freq.: 1.0 kHz ± 10% Voltage: 1.0Vrms ± 0.2V
Dissipation Factor		≤ 3.0% for ≥ 25V DC rating ≤ 12.5% for ≤ 16V DC rating	
Insulation Resistance		100 MΩ - μF	Charge device with rated voltage for 120 ± 5 secs @ room temp/humidity
Dielectric Strength		No breakdown or visual defects	Charge device with 300% of rated voltage for 1-5 seconds, with charge and discharge current limited to 50 mA (max)
Resistance to Flexure Stresses	Appearance	No defects	Deflection: 2mm Test Time: 30 seconds
	Capacitance Variation	≤ ±12%	
	Dissipation Factor	Meets Initial Values (As Above)	
	Insulation Resistance	≥ Initial Value x 0.3	
Solderability		≥ 95% of each terminal should be covered with fresh solder	Dip device in eutectic solder at 245 ± 5°C for 5.0 ± 0.5 seconds
Resistance to Solder Heat	Appearance	No defects, <25% leaching of either end terminal	Dip device in eutectic solder at 260°C for 60 seconds. Store at room temperature for 24 ± 2 hours before measuring electrical properties.
	Capacitance Variation	≤ ±7.5%	
	Dissipation Factor	Meets Initial Values (As Above)	
	Insulation Resistance	Meets Initial Values (As Above)	
	Dielectric Strength	Meets Initial Values (As Above)	
Load Life	Appearance	No visual defects	Charge device with 1.5X rated voltage in test chamber set at 85°C ± 2°C for 1000 hours (+48, -0) Remove from test chamber and stabilize at room temperature for 24 ± 2 hours before measuring.
	Capacitance Variation	≤ ±12%	
	Dissipation Factor	≤ Initial Value x 2.0 (As Above)	
	Insulation Resistance	≥ Initial Value x 0.3 (As Above)	
	Dielectric Strength	Meets Initial Values (As Above)	
Load Humidity	Appearance	No visual defects	Store in a test chamber set at 85°C ± 2°C/ 85% ± 5% relative humidity for 1000 hours (+48, -0) with rated voltage applied. Remove from chamber and stabilize at room temperature and humidity for 24 ± 2 hours before measuring.
	Capacitance Variation	≤ ±12%	
	Dissipation Factor	≤ Initial Value x 2.0 (As Above)	
	Insulation Resistance	≥ Initial Value x 0.3 (As Above)	
	Dielectric Strength	Meets Initial Values (As Above)	

Automotive MLCC

Automotive

GENERAL DESCRIPTION

AVX Corporation has supported the Automotive Industry requirements for Multilayer Ceramic Capacitors consistently for more than 10 years. Products have been developed and tested specifically for automotive applications and all manufacturing facilities are QS9000 and VDA 6.4 approved.

As part of our sustained investment in capacity and state of the art technology, we are now transitioning from the established Pd/Ag electrode system to a Base Metal Electrode system (BME).

AVX is using AECQ200 as the qualification vehicle for this transition. A detailed qualification package is available on request and contains results on a range of part numbers including:

- X7R dielectric components containing BME electrode and copper terminations with a Ni/Sn plated overcoat.
- X7R dielectric components, BME electrode with epoxy finish for conductive glue mounting.
- X7R dielectric components BME electrode and soft terminations with a Ni/Sn plated overcoat.
- NP0 dielectric components containing Pd/Ag electrode and silver termination with a Ni/Sn plated overcoat.

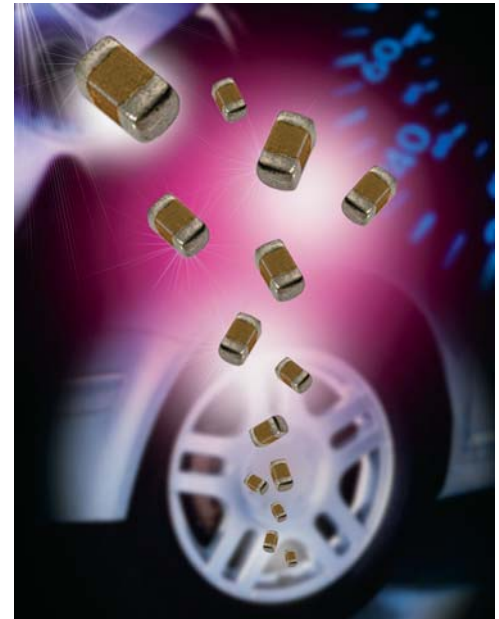

HOW TO ORDER

0805	5	A	104	K	4	T	2	A
Size	Voltage	Dielectric	Capacitance Code (In pF)	Capacitance Tolerance	Failure Rate	Terminations	Packaging	Special Code
0402	10V = Z	NP0 = A	2 Significant Digits + Number of Zeros	F = ±1% (≥10pF)* G = ±2% (≥10pF)* J = ±5% (≤1µF) K = ±10% M = ±20%	4 = Automotive	T = Plated Ni and Sn Z = FLEXITERM®*** U = Conductive Epoxy**	2 = 7" Reel 4 = 13" Reel	A = Std. Product
0603	16V = Y	X7R = C	e.g. 10µF = 106					
0805	25V = 3	X8R = F						
1206	50V = 5							
1210	100V = 1							
1812	200V = 2 500V = 7							
				*NPO only		**X7R & X8R only		

Contact factory for availability of Tolerance Options for Specific Part Numbers.

NOTE: Contact factory for non-specified capacitance values.
0402 case size available in T termination only.

COMMERCIAL VS AUTOMOTIVE MLCC PROCESS COMPARISON

	Commercial	Automotive
Administrative	Standard Part Numbers. No restriction on who purchases these parts.	Specific Automotive Part Number. Used to control supply of product to Automotive customers.
Design	Minimum ceramic thickness of 0.020"	Minimum Ceramic thickness of 0.029" (0.74mm) on all X7R product.
Dicing	Side & End Margins = 0.003" min	Side & End Margins = 0.004" min Cover Layers = 0.003" min
Lot Qualification (Destructive Physical Analysis - DPA)	As per EIA RS469	Increased sample plan – stricter criteria.
Visual/Cosmetic Quality	Standard process and inspection	100% inspection
Application Robustness	Standard sampling for accelerated wave solder on X7R dielectrics	Increased sampling for accelerated wave solder on X7R and NP0 followed by lot by lot reliability testing.

All Tests have Accept/Reject Criteria 0/1



Automotive MLCC

NP0/X7R Dielectric

FLEXITERM® FEATURES

a) Bend Test

The capacitor is soldered to the PC Board as shown:

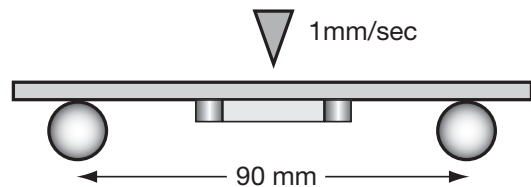

Typical bend test results are shown below:

Style	Conventional Term	Soft Term
0603	>2mm	>5
0805	>2mm	>5
1206	>2mm	>5

b) Temperature Cycle testing

FLEXITERM® has the ability to withstand at least 1000 cycles between -55°C and $+125^{\circ}\text{C}$

Automotive MLCC - NP0

Capacitance Range

Soldering	0603			0805			1206					1210				
	Reflow/Wave			Reflow/Wave			Reflow/Wave					Reflow Only				
	25V	50V	100V	25V	50V	100V	25V	50V	100V	200V	500V	25V	50V	100V	200V	
100	10pF	G	G	G	J	J	J	J	J	J	J	J				
120	12	G	G	G	J	J	J	J	J	J	J	J				
150	15	G	G	G	J	J	J	J	J	J	J	J				
180	18	G	G	G	J	J	J	J	J	J	J	J				
220	22	G	G	G	J	J	J	J	J	J	J	J				
270	27	G	G	G	J	J	J	J	J	J	J	J				
330	33	G	G	G	J	J	J	J	J	J	J	J				
390	39	G	G	G	J	J	J	J	J	J	J	J				
470	47	G	G	G	J	J	J	J	J	J	J	J				
510	51	G	G	G	J	J	J	J	J	J	J	J				
560	56	G	G	G	J	J	J	J	J	J	J	J				
680	68	G	G	G	J	J	J	J	J	J	J	J				
820	82	G	G	G	J	J	J	J	J	J	J	J				
101	100	G	G	G	J	J	J	J	J	J	J	J				
121	120	G	G	G	J	J	J	J	J	J	J	J				
151	150	G	G	G	J	J	J	J	J	J	J	J				
181	180	G	G	G	J	J	J	J	J	J	J	J				
221	220	G	G	G	J	J	J	J	J	J	J	J				
271	270	G	G	G	J	J	J	J	J	J	J	J				
331	330	G	G	G	J	J	J	J	J	J	J	J				
391	390	G	G		J	J	J	J	J	J	J	J				
471	470	G	G		J	J	J	J	J	J	J	J				
561	560				J	J	J	J	J	J	J	J				
681	680				J	J	J	J	J	J	J	J				
821	820				J	J	J	J	J	J	J	J				
102	1000				J	J	J	J	J	J	J	J	J	J	J	
122	1200				J			J	J	J	J	J	J	M	M	
152	1500				J			J	M	M	M	J	J	M	M	
182	1800				J			J	M	M	M	J	J	M	M	
222	2200				J			J	M	M	M	J	J	M	M	
272	2700				J			J	M			J	J	M		
332	3300							J	M			J	J	P		
392	3900							J	M			J	J	P		
472	4700							J	M			J	J	P		
103	10nF															
		25V	50V	100V	25V	50V	100V	25V	50V	100V	200V	500V	25V	50V	100V	200V
		0603			0805			1206					1210			

Letter	A	C	E	G	J	K	M	N	P	Q	X	Y	Z
Max. Thickness	0.33 (0.013)	0.56 (0.022)	0.71 (0.028)	0.90 (0.035)	0.94 (0.037)	1.02 (0.040)	1.27 (0.050)	1.40 (0.055)	1.52 (0.060)	1.78 (0.070)	2.29 (0.090)	2.54 (0.100)	2.79 (0.110)
	PAPER					EMBOSSSED							

Automotive MLCC - X8R

Capacitance Range

SIZE			0603		0805		1206	
Soldering			Reflow/Wave		Reflow/Wave		Reflow/Wave	
	WVDC		25V	50V	25V	50V	25V	50V
271	Cap	270	G	G				
331	(pF)	330	G	G	J	J		
471		470	G	G	J	J		
681		680	G	G	J	J		
102		1000	G	G	J	J	J	J
152		1500	G	G	J	J	J	J
182		1800	G	G	J	J	J	J
222		2200	G	G	J	J	J	J
272		2700	G	G	J	J	J	J
332		3300	G	G	J	J	J	J
392		3900	G	G	J	J	J	J
472		4700	G	G	J	J	J	J
562		5600	G	G	J	J	J	J
682		6800	G	G	J	J	J	J
822		8200	G	G	J	J	J	J
103	Cap	0.01	G	G	J	J	J	J
123	(µF)	0.012	G	G	J	J	J	J
153		0.015	G	G	J	J	J	J
183		0.018	G	G	J	J	J	J
223		0.022	G	G	J	J	J	J
273		0.027	G	G	J	J	J	J
333		0.033	G	G	J	J	J	J
393		0.039	G	G	J	J	J	J
473		0.047	G	G	J	J	J	J
563		0.056	G		N	N	M	M
683		0.068	G		N	N	M	M
823		0.082			N	N	M	M
104		0.1			N	N	M	M
124		0.12			N	N	M	M
154		0.15			N	N	M	M
184		0.18			N		M	M
224		0.22			N		M	M
274		0.27					M	M
334		0.33					M	M
394		0.39					M	
474		0.47					M	
684		0.68						
824		0.82						
105		1						
	WVDC		25V	50V	25V	50V	25V	50V
SIZE			0603		0805		1206	

Letter	A	C	E	G	J	K	M	N	P	Q	X	Y	Z
Max. Thickness	0.33 (0.013)	0.56 (0.022)	0.71 (0.028)	0.90 (0.035)	0.94 (0.037)	1.02 (0.040)	1.27 (0.050)	1.40 (0.055)	1.52 (0.060)	1.78 (0.070)	2.29 (0.090)	2.54 (0.100)	2.79 (0.110)
	PAPER					EMBOSSSED							

APS Series for Higher Reliability Applications

Surface Mount NPO, X7R and X8R/L MLCCs

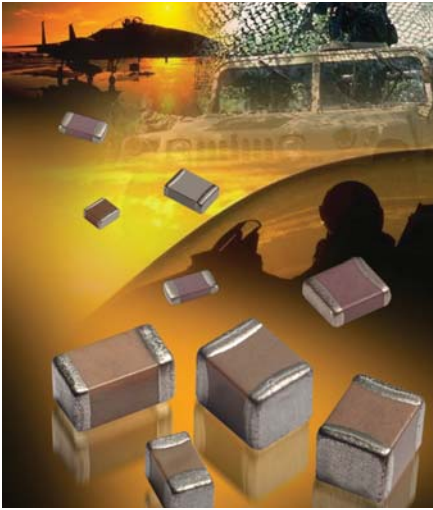

AVX's APS series of multilayer ceramic capacitors offers the customer a higher reliability solution with an ultralow failure rate, ≤ 1 ppb, in a variety of case sizes and voltages. The APS range encompasses a wide range of dielectric types to meet the customer's requirements from low temperature/voltage capacitance change dielectric, NPO, to high performing capacitance voltage X7R to high temperature reliability dielectrics, X8R/L.

APS capacitors have a wider capacitance range than MIL spec parts that satisfies the need for higher CV demands and board space saving requirements. Each production lot is extensively tested and removes the requirement for customer specific drawings. The testing regime uses many of the MIL-STD test methods as per MIL-PRF-55681 and has a field failure rate of less than 1 ppb. The APS testing series uses AVX's unique in-house maverick testing detection system that eliminates infant mortality failures.

Applications suitable for APS include Industrial, Telecommunications, Aviation, and Military. The APS is available with a range of different termination finishes, Flexiterm®, Nickel / Tin and Tin with Pb¹. Flexiterm® technology delivers improved thermo-mechanical stress resistance.

AVX'S APS RELIABILITY TEST SUMMARY

- 100 % Visual Inspection
- DPA
- IR, DF, Cap, DWV
- Maverick Lot Review
- Thermal Shock
- 85/85 Testing
- Life Testing 125°C 2xRV
- C of C with every Order
- Quarterly Data Package

Dielectric	Temperature/Percentage Cap Change
NPO	-30ppm +30ppm from -55°C to + 125°C
X7R	-15% +15% from -55°C to + 125°C
X8R	-15% +15% from -55°C to + 150°C
X8L	-15% +40% from -55°C to + 150°C

FEATURES

- The APS range has extensive reliability testing as standard resulting in an ultralow failure rate, ≤ 1 ppb.
- The APS range is available with Flexiterm® that deliver's high thermo-mechanical stress resistance.
- High CV range enabling board space saving requirements.

HOW TO ORDER

AP03	5	A	104	K	Q	T	2	A
Size	Voltage	Dielectric	Capacitance Code (In pF)	Capacitance Tolerance	Failure Rate	Terminations	Packaging	Special Code
AP03=0603	16V = Y	NPO = A	2 Significant Digits + Number of Zeros e.g. 10µF = 106	J = ±5% K = ±10% M = ±20%	Q = APS	T = Plated Ni and Sn** Z = FLEXITERM®*** B = 10% min lead X = FLEXITERM® with 10% min lead	2 = 7" Reel 4 = 13" Reel	A = Std. Product
AP05=0805	25V = 3	X7R = C						
AP06=1206	50V = 5	X8R = F						
AP10=1210	100V = 1	X8L = L						
AP12=1812	200V = 2							
AP20=2220	500V = 7							

Z,X for X7R only
**RoHS compliant

NOTE: Contact factory for availability of Termination and Tolerance Options for Specific Part Numbers.

NP0 APS Series

Capacitance Range

		AP03 = 0603			AP05 = 0805			AP06 = 1206					AP10 = 1210			
		25V	50V	100V	25V	50V	100V	25V	50V	100V	200V	500V	25V	50V	100V	200V
100	10pF	G	G	G	J	J	J	J	J	J	J	J				
120	12	G	G	G	J	J	J	J	J	J	J	J				
150	15	G	G	G	J	J	J	J	J	J	J	J				
180	18	G	G	G	J	J	J	J	J	J	J	J				
220	22	G	G	G	J	J	J	J	J	J	J	J				
270	27	G	G	G	J	J	J	J	J	J	J	J				
330	33	G	G	G	J	J	J	J	J	J	J	J				
390	39	G	G	G	J	J	J	J	J	J	J	J				
470	47	G	G	G	J	J	J	J	J	J	J	J				
510	51	G	G	G	J	J	J	J	J	J	J	J				
560	56	G	G	G	J	J	J	J	J	J	J	J				
680	68	G	G	G	J	J	J	J	J	J	J	J				
820	82	G	G	G	J	J	J	J	J	J	J	J				
101	100	G	G	G	J	J	J	J	J	J	J	J				
121	120	G	G	G	J	J	J	J	J	J	J	J				
151	150	G	G	G	J	J	J	J	J	J	J	J				
181	180	G	G	G	J	J	J	J	J	J	J	J				
221	220	G	G	G	J	J	J	J	J	J	J	J				
271	270	G	G	G	J	J	J	J	J	J	J	J				
331	330	G	G	G	J	J	J	J	J	J	J	J				
391	390	G	G		J	J	J	J	J	J	J	J				
471	470	G	G		J	J	J	J	J	J	J	J				
561	560				J	J	J	J	J	J	J	J				
681	680				J	J	J	J	J	J	J	J				
821	820				J	J	J	J	J	J	J	J				
102	1000				J	J	J	J	J	J	J	J	J	J	J	J
122	1200							J	J	J			J	J	M	M
152	1500							J	M	M			J	J	M	M
182	1800							J	M	M			J	J	M	M
222	2200							J	M	M			J	J	M	M
272	2700							J	M				J	J		
332	3300							J	M				J	J		
392	3900												J	J		
472	4700												J	J		
103	10nF															
		25V	50V	100V	25V	50V	100V	25V	50V	100V	200V	500V	25V	50V	100V	200V
		AP03 = 0603			AP05 = 0805			AP06 = 1206					AP10 = 1210			



Letter	A	C	E	G	J	K	M	N	P	Q	X	Y	Z
Max.	0.33	0.56	0.71	0.90	0.94	1.02	1.27	1.40	1.52	1.78	2.29	2.54	2.79
Thickness	(0.013)	(0.022)	(0.028)	(0.035)	(0.037)	(0.040)	(0.050)	(0.055)	(0.060)	(0.070)	(0.090)	(0.100)	(0.110)
	PAPER					EMBOSSSED							

TS 16949, ISO 9001 Certified

X7R APS Series

Capacitance Range

		AP03 = 0603					AP05 = 0805					AP06 = 1206					AP10 = 1210				AP12 = 1812		AP20 = 2220		
		16V	25V	50V	100V	200V	16V	25V	50V	100V	200V	16V	25V	50V	100V	200V	500V	16V	25V	50V	100V	50V	100V	25V	50V
102	Cap 1000	G	G	G	G	G	J	J	J	J	J	J	J	J	J	J	J	K	K	K	K	K	K		
182	(pF) 1800	G	G	G	G		J	J	J	J	J	J	J	J	J	J	J	K	K	K	K	K	K		
222	2200	G	G	G	G		J	J	J	J	J	J	J	J	J	J	J	K	K	K	K	K	K		
332	3300	G	G	G	G		J	J	J	J	J	J	J	J	J	J	J	K	K	K	K	K	K		
472	4700	G	G	G	G		J	J	J	J	J	J	J	J	J	J	J	K	K	K	K	K	K		
103	0.01	G	G	G	G		J	J	J	J	J	J	J	J	J	J	J	K	K	K	K	K	K		
123	0.012	G	G	G			J	J	J	M		J	J	J	J	J		K	K	K	K	K	K		
153	0.015	G	G	G			J	J	J	M		J	J	J	J	J		K	K	K	K	K	K		
183	0.018	G	G	G			J	J	J	M		J	J	J	J	J		K	K	K	K	K	K		
223	0.022	G	G	G			J	J	J	M		J	J	J	J	J		K	K	K	K	K	K		
273	0.027	G	G	G			J	J	J	M		J	J	J	J	J		K	K	K	K	K	K		
333	0.033	G	G	G			J	J	J	M		J	J	J	J	J		K	K	K	K	K	K		
473	0.047	G	G	G			J	J	J	M		J	J	J	M	J		K	K	K	K	K	K		
563	0.056	G	G	G			J	J	J	M		J	J	J	M	J		K	K	K	M	K	K		
683	0.068	G	G	G			J	J	J	M		J	J	J	M	J		K	K	K	M	K	K		
823	0.082	G	G	G			J	J	J	M		J	J	J	M	J		K	K	K	M	K	K		
104	0.1	G	G	G			J	J	M	M		J	J	J	M	J		K	K	K	M	K	K		
124	0.12						J	J	M			J	J	M	M			K	K	K	P	K	K		
154	0.15						M	N	M			J	J	M	M			K	K	K	P	K	K		
224	0.22						M	N	M			J	M	M	Q			M	M	M	P	M	M		
334	0.33						N	N	M			J	M	P	Q			P	P	P	Q	X	X		
474	0.47						N	N	M			M	M	P	Q			P	P	P	Q	X	X		
684	0.68						N	N				M	Q	Q	Q			P	P	Q	X	X	X		
105	Cap 1.0						N	N				M	Q	Q	Q			P	Q	Q	X	X	X		
155	(µF) 1.5											Q	Q					P	Q	Z	Z	X	X		
225	2.2											Q	Q					X	Z	Z	Z	Z	Z		
335	3.3																	X	Z	Z		Z			
475	4.7																	X	Z	Z		Z			
106	10																								Z
226	22																								Z
		16V	25V	50V	100V	200V	16V	25V	50V	100V	200V	16V	25V	50V	100V	200V	500V	16V	25V	50V	100V	50V	100V	25V	50V
		AP03 = 0603					AP05 = 0805					AP06 = 1206					AP10 = 1210				AP12 = 1812		AP20 = 2220		

Letter	A	C	E	G	J	K	M	N	P	Q	X	Y	Z
Max. Thickness	0.33 (0.013)	0.56 (0.022)	0.71 (0.028)	0.90 (0.035)	0.94 (0.037)	1.02 (0.040)	1.27 (0.050)	1.40 (0.055)	1.52 (0.060)	1.78 (0.070)	2.29 (0.090)	2.54 (0.100)	2.79 (0.110)
	PAPER					EMBOSSED							

X8R/L APS Series

Capacitance Range

X8R

SIZE			0603		0805		1206	
	WVDC		25V	50V	25V	50V	25V	50V
331	Cap	330	G	G	J	J		
471	(pF)	470	G	G	J	J		
681		680	G	G	J	J		
102		1000	G	G	J	J	J	J
152		1500	G	G	J	J	J	J
222		2200	G	G	J	J	J	J
332		3300	G	G	J	J	J	J
472		4700	G	G	J	J	J	J
682		6800	G	G	J	J	J	J
103	Cap	0.01	G	G	J	J	J	J
153	(µF)	0.015	G	G	J	J	J	J
223		0.022	G	G	J	J	J	J
333		0.033	G	G	J	J	J	J
473		0.047	G	G	J	J	J	J
683		0.068	G		N	N	M	M
104		0.1			N	N	M	M
154		0.15			N	N	M	M
224		0.22			N		M	M
334		0.33					M	M
474		0.47					M	
684		0.68						
105		1						
WVDC			25V	50V	25V	50V	25V	50V
SIZE			0603		0805		1206	

X8L

SIZE			0603			0805			1206			
	WVDC		25V	50V	100V	25V	50V	100V	16V	25V	50V	100V
331	Cap	330		G	G		J	J				
471	(pF)	470		G	G		J	J				
681		680		G	G		J	J				
102		1000		G	G		J	J				
152		1500		G	G		J	J			J	J
222		2200		G	G		J	J			J	J
332		3300		G	G		J	J			J	J
472		4700		G	G		J	J			J	J
682		6800		G	G		J	J			J	J
103	Cap	0.01		G	G		J	J			J	J
153	(µF)	0.015	G	G		J	J	J			J	J
223		0.022	G	G		J	J	J			J	J
333		0.033	G	G		J	J	N			J	J
473		0.047	G	G		J	J	N			J	J
683		0.068	G	G		J	J				J	J
104		0.1	G	G		J	J				J	M
154		0.15				J	N		J	J	J	Q
224		0.22				N	N		J	J	J	Q
334		0.33				N			J	M	P	Q
474		0.47				N			M	M	P	
684		0.68							M			
105		1							M			
WVDC			25V	50V	100V	25V	50V	100V	16V	25V	50V	100V
SIZE			0603			0805			1206			

Letter	A	C	E	G	J	K	M	N	P	Q	X	Y	Z
Max. Thickness	0.33 (0.013)	0.56 (0.022)	0.71 (0.028)	0.90 (0.035)	0.94 (0.037)	1.02 (0.040)	1.27 (0.050)	1.40 (0.055)	1.52 (0.060)	1.78 (0.070)	2.29 (0.090)	2.54 (0.100)	2.79 (0.110)
	PAPER					EMBOSSED							



TS 16949, ISO 9001 Certified

MLCC with FLEXITERM®

General Specifications

GENERAL DESCRIPTION

With increased requirements from the automotive industry for additional component robustness, AVX recognized the need to produce a MLCC with enhanced mechanical strength. It was noted that many components may be subject to severe flexing and vibration when used in various under the hood automotive and other harsh environment applications.

To satisfy the requirement for enhanced mechanical strength, AVX had to find a way of ensuring electrical integrity is maintained whilst external forces are being applied to the component. It was found that the structure of the termination needed to be flexible and after much research and development, AVX launched FLEXITERM®. FLEXITERM® is designed to enhance the mechanical flexure and temperature cycling performance of a standard ceramic capacitor with an X7R dielectric. **The industry standard for flexure is 2mm minimum. Using FLEXITERM®, AVX provides up to 5mm of flexure without internal cracks. Beyond 5mm, the capacitor will generally fail “open”.**

As well as for automotive applications FLEXITERM® will provide Design Engineers with a satisfactory solution when designing PCB's which may be subject to high levels of board flexure.

PRODUCT ADVANTAGES

- High mechanical performance able to withstand, 5mm bend test guaranteed.
- Increased temperature cycling performance, 3000 cycles and beyond.
- Flexible termination system.
- Reduction in circuit board flex failures.
- Base metal electrode system.
- Automotive or commercial grade products available.

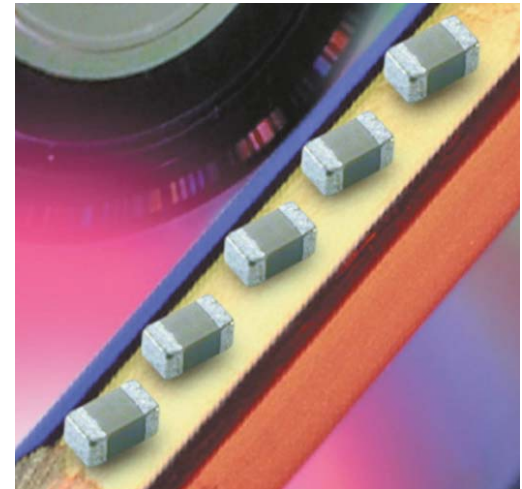

APPLICATIONS

High Flexure Stress Circuit Boards

- e.g. Depanelization: Components near edges of board.

Variable Temperature Applications

- Soft termination offers improved reliability performance in applications where there is temperature variation.
- e.g. All kind of engine sensors: Direct connection to battery rail.

Automotive Applications

- Improved reliability.
- Excellent mechanical performance and thermo mechanical performance.

HOW TO ORDER

0805

Style

0603
0805
1206
1210
1812
2220

5

Voltage

6 = 6.3V
Z = 10V
Y = 16V
3 = 25V
5 = 50V
1 = 100V
2 = 200V

C

Dielectric

C = X7R
F = X8R

104

Capacitance Code (In pF)

2 Sig Digits +
Number of Zeros
e.g., 104 = 100nF

K

Capacitance Tolerance

J = ±5%*
K = ±10%
M = ±20%

*≤1µF only

A

Failure Rate

A=Commercial
4 = Automotive

Z

Terminations

Z = FLEXITERM®
For FLEXITERM®
with Tin/Lead
termination see
AVX LD Series

2

Packaging

2 = 7" reel
4 = 13" reel

A

Special Code

A = Std. Product



NOTE: Contact factory for availability of Tolerance Options for Specific Part Numbers.

MLCC with FLEXITERM®

Specifications and Test Methods

PERFORMANCE TESTING

AEC-Q200 Qualification:

- Created by the Automotive Electronics Council
- Specification defining stress test qualification for passive components



Testing:

Key tests used to compare soft termination to AEC-Q200 qualification:

- Bend Test
- Temperature Cycle Test

BOARD BEND TEST RESULTS

AEC-Q200 Vrs AVX FLEXITERM® Bend Test

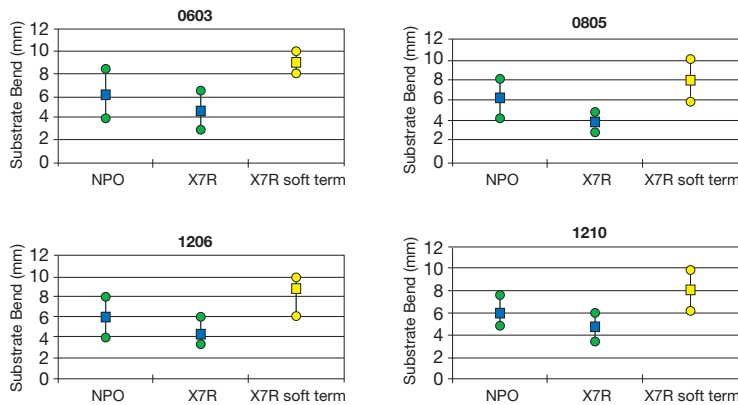

TABLE SUMMARY

Typical bend test results are shown below:

Style	Conventional Termination	FLEXITERM®
0603	>2mm	>5mm
0805	>2mm	>5mm
1206	>2mm	>5mm

TEMPERATURE CYCLE TEST PROCEDURE

Test Procedure as per AEC-Q200:

The test is conducted to determine the resistance of the component when it is exposed to extremes of alternating high and low temperatures.

- Sample lot size quantity 77 pieces
- TC chamber cycle from -55°C to +125°C for 1000 cycles
- Interim electrical measurements at 250, 500, 1000 cycles
- Measure parameter capacitance dissipation factor, insulation resistance

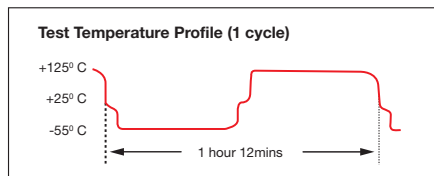

BOARD BEND TEST PROCEDURE

According to AEC-Q200

Test Procedure as per AEC-Q200:

Sample size: 20 components
Span: 90mm Minimum deflection spec: 2 mm

- Components soldered onto FR4 PCB (Figure 1)
- Board connected electrically to the test equipment (Figure 2)

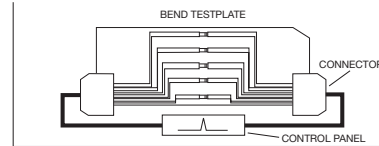

Fig 1 - PCB layout with electrical connections

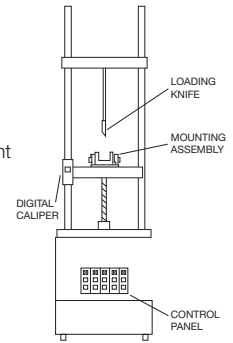
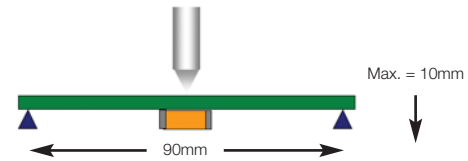

Fig 2 - Board Bend test equipment

AVX ENHANCED SOFT TERMINATION BEND TEST PROCEDURE

Bend Test

The capacitor is soldered to the printed circuit board as shown and is bent up to 10mm at 1 mm per second:



- The board is placed on 2 supports 90mm apart (capacitor side down)
- The row of capacitors is aligned with the load stressing knife

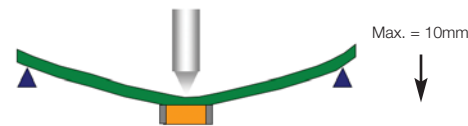

- The load is applied and the deflection where the part starts to crack is recorded (Note: Equipment detects the start of the crack using a highly sensitive current detection circuit)
- The maximum deflection capability is 10mm

MLCC with FLEXITERM®

Specifications and Test Methods

BEYOND 1000 CYCLES: TEMPERATURE CYCLE TEST RESULTS

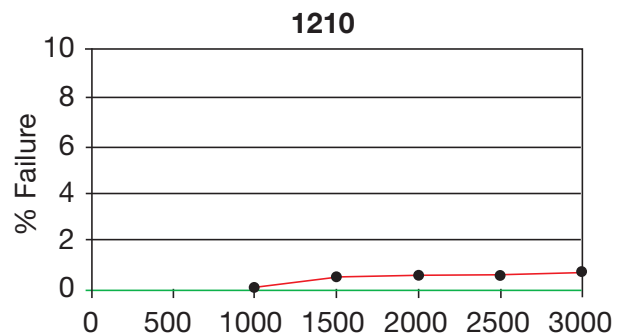
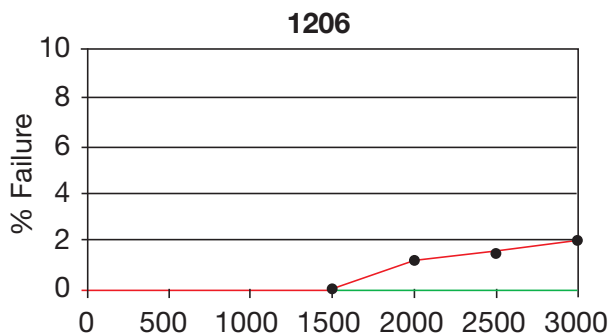
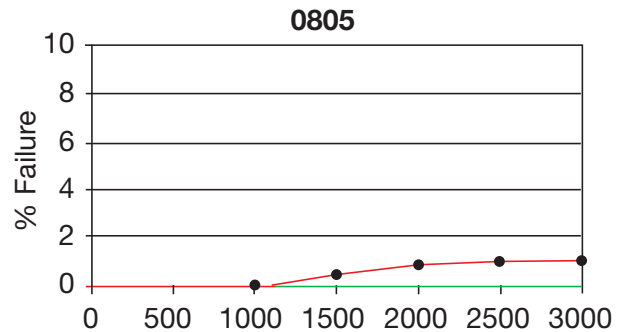
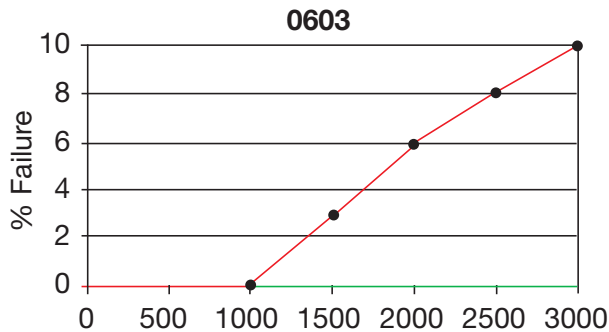

Soft Term - No Defects up to 3000 cycles

AEC-Q200 specification states 1000 cycles compared to AVX 3000 temperature cycles.

FLEXITERM® TEST SUMMARY

- Qualified to AEC-Q200 test/specification with the exception of using AVX 3000 temperature cycles (up to +150°C bend test guaranteed greater than 5mm).
- FLEXITERM® provides improved performance compared to standard termination systems.
- Board bend test improvement by a factor of 2 to 4 times.
- Temperature Cycling:
 - 0% Failure up to 3000 cycles
 - No ESR change up to 3000 cycles

WITHOUT SOFT TERMINATION

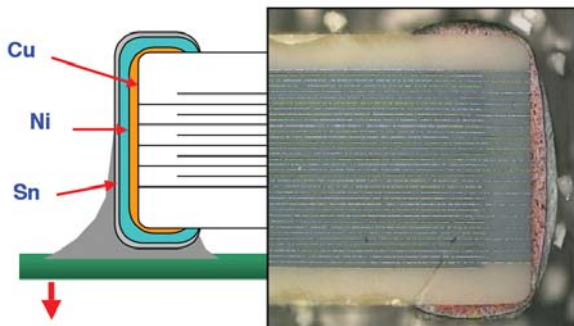

Major fear is of latent board flex failures.

WITH SOFT TERMINATION

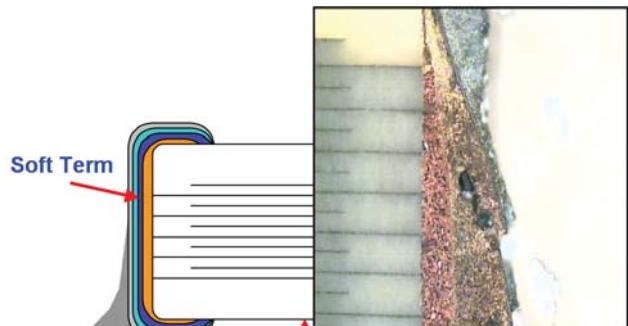

Far superior mechanical performance. Generally open failure mode beyond 5mm flexure.

MLCC with FLEXITERM®

X8R Dielectric Capacitance Range

SIZE		0603		0805		1206	
Soldering		Reflow/Wave		Reflow/Wave		Reflow/Wave	
	WVDC	25V	50V	25V	50V	25V	50V
271	Cap 270	G	G				
331	(pF) 330	G	G	J	J		
471	470	G	G	J	J		
681	680	G	G	J	J		
102	1000	G	G	J	J	J	J
152	1500	G	G	J	J	J	J
182	1800	G	G	J	J	J	J
222	2200	G	G	J	J	J	J
272	2700	G	G	J	J	J	J
332	3300	G	G	J	J	J	J
392	3900	G	G	J	J	J	J
472	4700	G	G	J	J	J	J
562	5600	G	G	J	J	J	J
682	6800	G	G	J	J	J	J
822	8200	G	G	J	J	J	J
103	Cap 0.01	G	G	J	J	J	J
123	(µF) 0.012	G	G	J	J	J	J
153	0.015	G	G	J	J	J	J
183	0.018	G	G	J	J	J	J
223	0.022	G	G	J	J	J	J
273	0.027	G	G	J	J	J	J
333	0.033	G	G	J	J	J	J
393	0.039	G	G	J	J	J	J
473	0.047	G	G	J	J	J	J
563	0.056	G		N	N	M	M
683	0.068	G		N	N	M	M
823	0.082			N	N	M	M
104	0.1			N	N	M	M
124	0.12			N	N	M	M
154	0.15			N	N	M	M
184	0.18			N		M	M
224	0.22			N		M	M
274	0.27					M	M
334	0.33					M	M
394	0.39					M	
474	0.47					M	
684	0.68						
824	0.82						
105	1						
	WVDC	25V	50V	25V	50V	25V	50V
SIZE		0603		0805		1206	

Letter	A	C	E	G	J	K	M	N	P	Q	X	Y	Z
Max. Thickness	0.33 (0.013)	0.56 (0.022)	0.71 (0.028)	0.90 (0.035)	0.94 (0.037)	1.02 (0.040)	1.27 (0.050)	1.40 (0.055)	1.52 (0.060)	1.78 (0.070)	2.29 (0.090)	2.54 (0.100)	2.79 (0.110)
	PAPER					EMBOSSED							

AEC-Q200 Qualified

MLCC with FLEXITERM®

X7R Dielectric Capacitance Range

Soldering	0402			0603						0805					1206						1210				1812		2220						
	16V	25V	50V	10V	16V	25V	50V	100V	200V	250V	16V	25V	50V	100V	200V	250V	16V	25V	50V	100V	200V	250V	500V	16V	25V	50V	100V	50V	100V	25V	50V	100V	
221	Cap	220	C	C	C																												
271	(pF)	270	C	C	C																												
331		330	C	C	C																												
391		390	C	C	C																												
471		470	C	C	C																												
561		560	C	C	C																												
681		680	C	C	C																												
821		820	C	C	C																												
102		1000	C	C	C	G	G	G	G	G	G	J	J	J	J	J	J	J	J	J	J	J	J	J	K	K	K	K	K	K	K		
182		1800	C	C	C	G	G	G	G	G	G	J	J	J	J	J	J	J	J	J	J	J	J	J	K	K	K	K	K	K	K		
222		2200	C	C	C	G	G	G	G	G	G	J	J	J	J	J	J	J	J	J	J	J	J	J	K	K	K	K	K	K	K		
332		3300	C	C	C	G	G	G	G	G	G	J	J	J	J	J	J	J	J	J	J	J	J	J	K	K	K	K	K	K	K		
472		4700	C	C	C	G	G	G	G	G	G	J	J	J	J	J	J	J	J	J	J	J	J	J	K	K	K	K	K	K	K		
103	Cap	0.01	C			G	G	G	G	G	G	J	J	J	J	J	J	J	J	J	J	J	J	J	K	K	K	K	K	K	K		
123	(µF)	0.012	C			G	G	G				J	J	J	M	J	J	J	J	J	J	J	J		K	K	K	K	K	K	K		
153		0.015	C			G	G	G				J	J	J	M	J	J	J	J	J	J	J	J		K	K	K	K	K	K	K		
183		0.018	C			G	G	G				J	J	J	M	J	J	J	J	J	J	J	J		K	K	K	K	K	K	K		
223		0.022	C			G	G	G				J	J	J	M	J	J	J	J	J	J	J	J		K	K	K	K	K	K	K		
273		0.027	C			G	G	G				J	J	J	M	J	J	J	J	J	J	J	J		K	K	K	K	K	K	K		
333		0.033	C			G	G	G				J	J	J	M	J	J	J	J	J	J	J	J		K	K	K	K	K	K	K		
473		0.047				G	G	G				J	J	J	M	J	J	J	J	M	J	J		K	K	K	K	K	K	K			
563		0.056				G	G	G				J	J	J	M				J	J	M	J	J		K	K	K	M	K	K			
683		0.068				G	G	G				J	J	J	M	J	J			J	M	J	J		K	K	K	M	K	K			
823		0.082				G	G	G				J	J	J	M				J	M	J	M	J		K	K	K	M	K	K			
104		0.01				G	G	G				J	J	M	M				J	M	M	J	J		K	K	K	M	K	K			
124		0.12										J	J	M	N				J	M	M				K	K	K	P	K	K			
154		0.15										M	N	M	N				J	M	M				K	K	K	P	K	K			
224		0.22		G								M	N	M	N				J	M	M	Q			M	M	M	P	M	M			
334		0.33										N	N	M	N				J	M	P	Q			P	P	P	Q	X	X			
474		0.47										N	N	M	N				M	M	P	Q			P	P	P	Q	X	X			
684		0.68										N	N	N					M	Q	Q	Q			P	P	Q	X	X	X			
105		1										N	N	N					M	Q	Q	Q			P	Q	Q	X	X	X			
155		1.5																	Q	Q	Q				P	Q	Z	Z	X	X			
225		2.2																	Q	Q	Q				X	Z	Z	Z	Z	Z			
335		3.3																	Q	Q					X	Z	Z	Z	Z				
475		4.7																	Q	Q					X	Z	Z	Z	Z				
106		10																							Z	Z					Z	Z	
226		22																													Z	Z	Z
	16V	25V	50V	10V	16V	25V	50V	100V	200V	250V	16V	25V	50V	100V	200V	250V	16V	25V	50V	100V	200V	250V	500V	16V	25V	50V	100V	50V	100V	25V	50V	100V	
	0402			0603						0805					1206						1210				1812		2220						

Letter	A	C	E	G	J	K	M	N	P	Q	X	Y	Z
Max. Thickness	0.33 (0.013)	0.56 (0.022)	0.71 (0.028)	0.90 (0.035)	0.94 (0.037)	1.02 (0.040)	1.27 (0.050)	1.40 (0.055)	1.52 (0.060)	1.78 (0.070)	2.29 (0.090)	2.54 (0.100)	2.79 (0.110)
	PAPER					EMBOSSED							

FLEXISAFE MLC Chips

For Ultra Safety Critical Applications

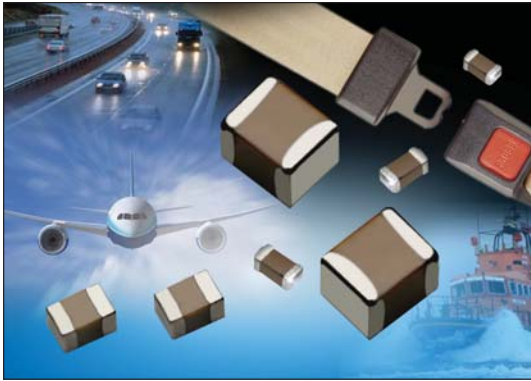

AVX have developed a range of components specifically for safety critical applications.

Utilizing the award-winning FLEXITERM™ layer in conjunction with the cascade design previously used for high voltage MLCCs, a range of ceramic capacitors is now available for customers who require components designed with an industry leading set of safety features.

The FLEXITERM™ layer protects the component from any damage to the ceramic resulting from mechanical stress during PCB assembly or use with end customers. Board flexure type mechanical damage accounts for the majority of MLCC failures. The addition of the cascade structure protects the component from low insulation resistance failure resulting from other common causes for failure; thermal stress damage, repetitive strike ESD damage and placement damage. With the inclusion of the cascade design structure to complement the FLEXITERM™ layer, the FLEXISAFE range of capacitors has unbeatable safety features.

HOW TO ORDER

FS03	5	C	104	K	Q	Z	2	A
Size	Voltage	Dielectric	Capacitance Code (In pF)	Capacitance Tolerance	Failure Rate	Terminations	Packaging	Special Code
FS03 = 0603 FS05 = 0805 FS06 = 1206 FS10 = 1210	16V = Y 25V = 3 50V = 5 100V = 1	X7R = C	2 Sig. Digits + Number of Zeros e.g. 10µF = 106	J = ±5% K = ±10% M = ±20%	A = Commercial 4 = Automotive Q = APS	Z = FLEXITERM™ X = FLEXITERM™ with 5% min lead	2 = 7" Reel 4 = 13" Reel	A = Std. Product

*Not RoHS Compliant

FLEXISAFE X7R RANGE

Capacitance Code		FS03 = 0603				FS05 = 0805				FS06 = 1206			FS10 = 1210		
		Reflow/Wave				Reflow/Wave				Reflow/Wave			Reflow Only		
Soldering		16	25	50	100	16	25	50	100	16	25	50	16	25	50
102	µF 0.001														
182	0.0018														
222	0.0022														
332	0.0033														
472	0.0047														
103	0.01														
123	0.012														
153	0.015														
183	0.018														
223	0.022														
273	0.027														
333	0.033														
473	0.047														
563	0.056														
683	0.068														
823	0.082														
104	0.1														
124	0.12														
154	0.15														
224	0.22														
334	0.33														
474	0.47														

Qualified



Capacitor Array

Capacitor Array (IPC)

BENEFITS OF USING CAPACITOR ARRAYS

AVX capacitor arrays offer designers the opportunity to lower placement costs, increase assembly line output through lower component count per board and to reduce real estate requirements.

Reduced Costs

Placement costs are greatly reduced by effectively placing one device instead of four or two. This results in increased throughput and translates into savings on machine time. Inventory levels are lowered and further savings are made on solder materials, etc.

Space Saving

Space savings can be quite dramatic when compared to the use of discrete chip capacitors. As an example, the 0508 4-element array offers a space reduction of >40% vs. 4 x 0402 discrete capacitors and of >70% vs. 4 x 0603 discrete capacitors. (This calculation is dependent on the spacing of the discrete components.)

Increased Throughput

Assuming that there are 220 passive components placed in a mobile phone:

A reduction in the passive count to 200 (by replacing discrete components with arrays) results in an increase in throughput of approximately 9%.

A reduction of 40 placements increases throughput by 18%.

For high volume users of cap arrays using the very latest placement equipment capable of placing 10 components per second, the increase in throughput can be very significant and can have the overall effect of reducing the number of placement machines required to mount components:

If 120 million 2-element arrays or 40 million 4-element arrays were placed in a year, the requirement for placement equipment would be reduced by one machine.

During a 20Hr operational day a machine places 720K components. Over a working year of 167 days the machine can place approximately 120 million. If 2-element arrays are mounted instead of discrete components, then the number of placements is reduced by a factor of two and in the scenario where 120 million 2-element arrays are placed there is a saving of one pick and place machine.

Smaller volume users can also benefit from replacing discrete components with arrays. The total number of placements is reduced thus creating spare capacity on placement machines. This in turn generates the opportunity to increase overall production output without further investment in new equipment.

W2A (0508) Capacitor Arrays

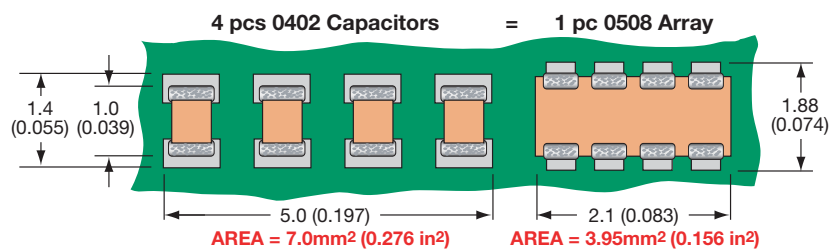

The 0508 4-element capacitor array gives a PCB space saving of over 40% vs four 0402 discretés and over 70% vs four 0603 discrete capacitors.

W3A (0612) Capacitor Arrays

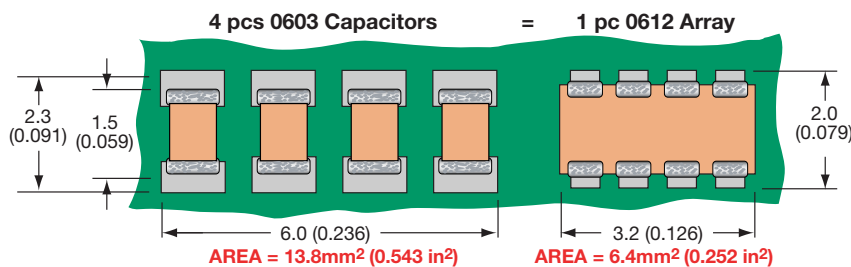

The 0612 4-element capacitor array gives a PCB space saving of over 50% vs four 0603 discretés and over 70% vs four 0805 discrete capacitors.

Capacitor Array

Capacitor Array (IPC)

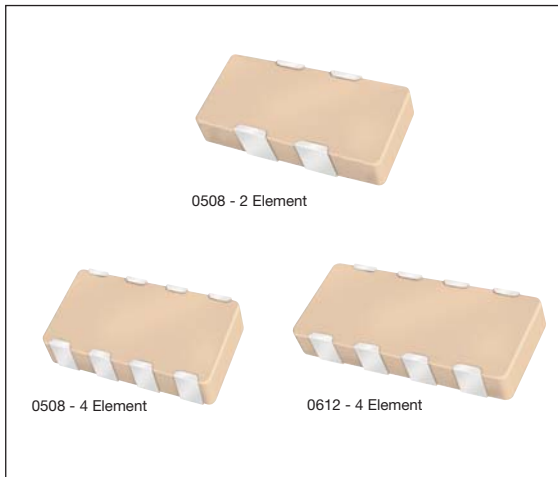

GENERAL DESCRIPTION

AVX is the market leader in the development and manufacture of capacitor arrays. The array family of products also includes the 0612 4-element device as well as 0508 2-element and 4-element series, all of which have received widespread acceptance in the marketplace.

AVX capacitor arrays are available in X5R, X7R and NP0 (COG) ceramic dielectrics to cover a broad range of capacitance values. Voltage ratings from 6.3 Volts up to 100 Volts are offered. AVX also now offers a range of automotive capacitor arrays qualified to AEC-Q200 (see separate table).

Key markets for capacitor arrays are Mobile and Cordless Phones, Digital Set Top Boxes, Computer Motherboards and Peripherals as well as Automotive applications, RF Modems, Networking Products, etc.

AVX Capacitor Array - W2A41A***K
S21 Magnitude

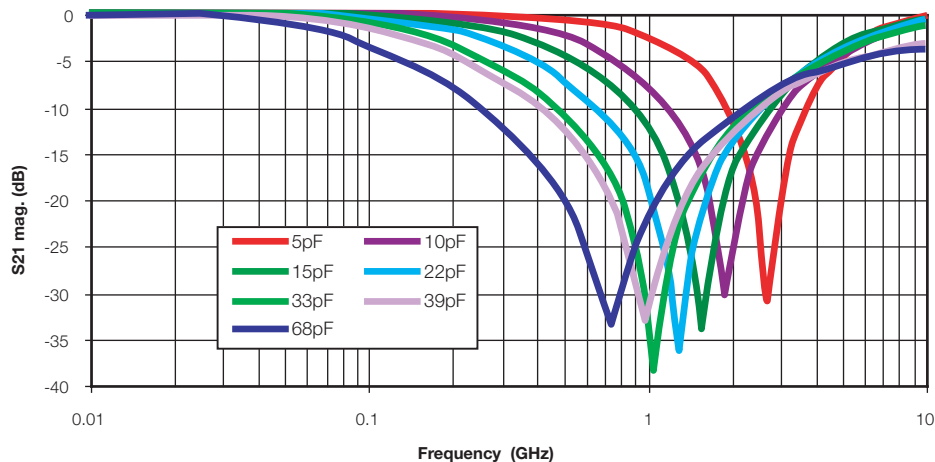

HOW TO ORDER

W	2	A	4	3	C	103	M	A	T	2A
Style W = RoHS L = SnPb	Case Size 2 = 0508 3 = 0612	Array	Number of Caps 2 = 2 Element 4 = 4 Element	Voltage 6 = 6V Z = 10V Y = 16V 3 = 25V 5 = 50V 1 = 100V	Dielectric A = NP0 C = X7R D = X5R	Capacitance Code 2 Sig Digits + Number of Zeros	Capacitance Tolerance J = ±5% K = ±10% M = ±20%	Failure Rate A = Commercial 4 = Automotive	Termination Code *T = Plated Ni and Sn *Z = FLEXITERM® *B = 5% min lead *X = FLEXITERM® with 5% min lead	Packaging & Quantity Code 2A = 7" Reel (4000) 4A = 13" Reel (10000) 2F = 7" Reel (1000)
									*RoHS Compliant	*Not RoHS Compliant



NOTE: Contact factory for availability of Termination and Tolerance Options for Specific Part Numbers.

Capacitor Array

Capacitance Range – NP0/COG

SIZE		W2 = 0508			W3 = 0612		
# Elements		4			4		
Soldering		Reflow/Wave			Reflow/Wave		
Packaging		Paper/Embossed			Paper/Embossed		
Length	mm	1.30 ± 0.15			1.60 ± 0.150		
	(in.)	(0.051 ± 0.006)			(0.063 ± 0.006)		
Width	mm	2.10 ± 0.15			3.20 ± 0.20		
	(in.)	(0.083 ± 0.006)			(0.126 ± 0.008)		
Max. Thickness	mm	0.94			1.35		
	(in.)	(0.037)			(0.053)		
WVDC		16	25	50	16	25	50
1R0	1.0						
1R2	1.2						
1R5	1.5						
1R8	1.8						
2R2	2.2						
2R7	2.7						
3R3	3.3						
3R9	3.9						
4R7	4.7						
5R6	5.6						
6R8	6.8						
8R2	8.2						
100	10						
120	12						
150	15						
180	18						
220	22						
270	27						
330	33						
390	39						
470	47						
560	56						
680	68						
820	82						
101	100						
121	120						
151	150						
181	180						
221	220						
271	270						
331	330						
391	390						
471	470						
561	560						
681	680						
821	820						
102	1000						
122	1200						
152	1500						
182	1800						
222	2200						
272	2700						
332	3300						
392	3900						
472	4700						
562	5600						
682	6800						
822	8200						

 = Supported Values

Capacitor Array

Capacitance Range – X7R

SIZE		W2 = 0508						W2 = 0508						W3 = 0612					
# Elements		2						4						4					
Soldering		Reflow/Wave						Reflow/Wave						Reflow/Wave					
Packaging		All Paper						Paper/Embossed						Paper/Embossed					
Length	mm	1.30 ± 0.15						1.30 ± 0.15						1.60 ± 0.150					
	(in.)	(0.051 ± 0.006)						(0.051 ± 0.006)						(0.063 ± 0.006)					
Width	mm	2.10 ± 0.15						2.10 ± 0.15						3.20 ± 0.20					
	(in.)	(0.083 ± 0.006)						(0.083 ± 0.006)						(0.126 ± 0.008)					
Max. Thickness	mm	0.94						0.94						1.35					
	(in.)	(0.037)						(0.037)						(0.053)					
WVDC		6	10	16	25	50	100	6	10	16	25	50	100	6	10	16	25	50	100
101	Cap	100																	
121	(pF)	120																	
151		150																	
181		180																	
221		220																	
271		270																	
331		330																	
391		390																	
471		470																	
561		560																	
681		680																	
821		820																	
102		1000																	
122		1200																	
152		1500																	
182		1800																	
222		2200																	
272		2700																	
332		3300																	
392		3900																	
472		4700																	
562		5600																	
682		6800																	
822		8200																	
103	Cap	0.010																	
123	(µF)	0.012																	
153		0.015																	
183		0.018																	
223		0.022																	
273		0.027																	
333		0.033																	
393		0.039																	
473		0.047																	
563		0.056																	
683		0.068																	
823		0.082																	
104		0.10																	
124		0.12																	
154		0.15																	
184		0.18																	
224		0.22																	
274		0.27																	
334		0.33																	
474		0.47																	
564		0.56																	
684		0.68																	
824		0.82																	
105		1.0																	
125		1.2																	
155		1.5																	
185		1.8																	
225		2.2																	
335		3.3																	
475		4.7																	
106		10																	
226		22																	
476		47																	
107		100																	

Automotive Capacitor Array (IPC)

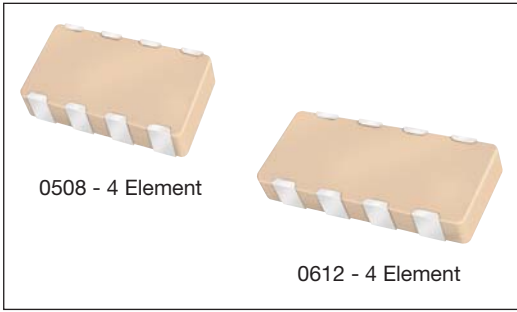

As the market leader in the development and manufacture of capacitor arrays AVX is pleased to offer a range of AEC-Q200 qualified arrays to compliment our product offering to the Automotive industry. Both the AVX 0612 and 0508 4-element capacitor array styles are qualified to the AEC-Q200 automotive specifications.

AEC-Q200 is the Automotive Industry qualification standard and a detailed qualification package is available on request.

All AVX automotive capacitor array production facilities are certified to ISO/TS 16949:2002.

HOW TO ORDER

W	3	A	4	Y	C	104	K	4	T	2A
↓	↓	↓	↓	↓	↓	↓	↓	↓	↓	↓
Style	Case Size	Array	Number of Caps	Voltage	Dielectric	Capacitance Code (In pF)	Capacitance Tolerance	Failure Rate	Terminations	Packaging & Quantity Code
W = RoHS L = SnPb	2 = 0508 3 = 0612			Z = 10V Y = 16V 3 = 25V 5 = 50V 1 = 100V	A = NPO C = X7R F = X8R	Significant Digits + Number of Zeros e.g. 10µF=106	*J = ±5% *K = ±10% M = ±20%	4 = Automotive	*T = Plated Ni and Sn *Z = FLEXITERM® B = 5% min lead X = FLEXITERM® with 5% min lead	2A = 7" Reel (4000) 4A = 13" Reel (10000) 2F = 7" Reel (1000)
									*RoHS compliant	

*Contact factory for availability by part number for K = ±10% and J = ±5% tolerance.

		NPO/COG							
SIZE	No. of Elements	W2 = 0508				W3 = 0612			
		4				4			
	WVDC	16	25	50	100	16	25	50	100
1R0	Cap 1.0								
1R2	(pF) 1.2								
1R5	1.5								
1R8	1.8								
2R2	2.2								
2R7	2.7								
3R3	3.3								
3R9	3.9								
4R7	4.7								
5R6	5.6								
6R8	6.8								
8R2	8.2								
100	10								
120	12								
150	15								
180	18								
220	22								
270	27								
330	33								
390	39								
470	47								
560	56								
680	68								
820	82								
101	100								
121	120								
151	150								
181	180								
221	220								
271	270								
331	330								
391	390								
471	470								
561	560								
681	680								
821	820								
102	1000								
122	1200								
152	1500								
182	1800								
222	2200								
272	2700								
332	3300								
392	3900								
472	4700								
562	5600								
682	6800								
822	8200								

■ = NPO/COG

		X7R												
SIZE	No. of Elements	W2 = 0508				W2 = 0508				W3 = 0612				
		2				4				4				
	WVDC	16	25	50	100	16	25	50	100	10	16	25	50	100
101	Cap 100													
121	(pF) 120													
151	150													
181	180													
221	220													
271	270													
331	330													
391	390													
471	470													
561	560													
681	680													
821	820													
102	1000													
122	1200													
152	1500													
182	1800													
222	2200													
272	2700													
332	3300													
392	3900													
472	4700													
562	5600													
682	6800													
822	8200													
103	Cap 0.010													
123	(µF) 0.012													
153	0.015													
183	0.018													
223	0.022													
273	0.027													
333	0.033													
393	0.039													
473	0.047													
563	0.056													
683	0.068													
823	0.082													
104	0.10													
124	0.12													
154	0.15													
224	0.22													

■ = X7R

Not RoHS Compliant



For RoHS compliant products, please select correct termination style.

Capacitor Array

PART & PAD LAYOUT DIMENSIONS

millimeters (inches)

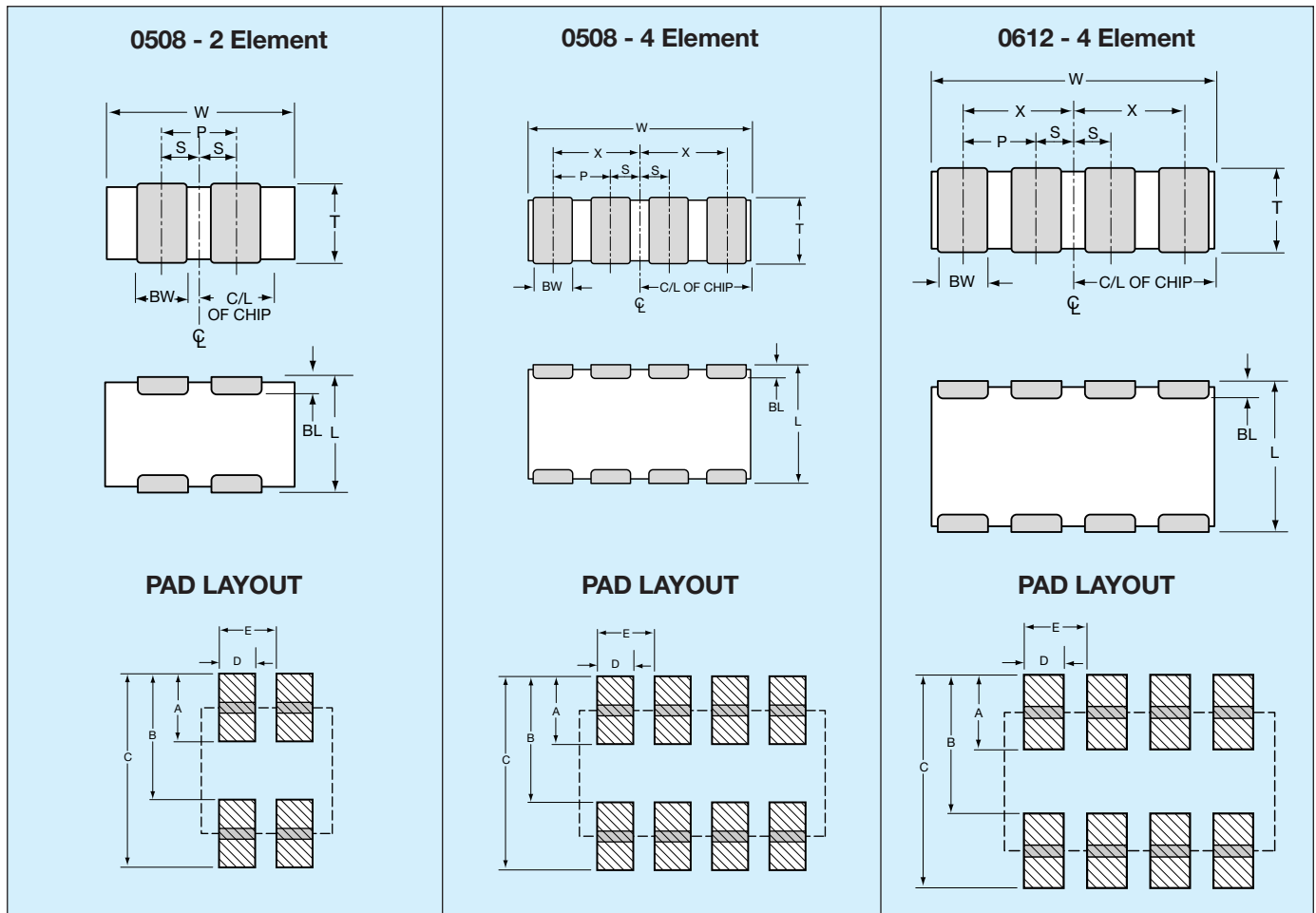

PART DIMENSIONS

0508 - 2 Element

L	W	T	BW	BL	P	S
1.30 ± 0.15 (0.051 ± 0.006)	2.10 ± 0.15 (0.083 ± 0.006)	0.94 MAX (0.037 MAX)	0.43 ± 0.10 (0.017 ± 0.004)	0.33 ± 0.08 (0.013 ± 0.003)	1.00 REF (0.039 REF)	0.50 ± 0.10 (0.020 ± 0.004)

0508 - 4 Element

L	W	T	BW	BL	P	X	S
1.30 ± 0.15 (0.051 ± 0.006)	2.10 ± 0.15 (0.083 ± 0.006)	0.94 MAX (0.037 MAX)	0.25 ± 0.06 (0.010 ± 0.003)	0.20 ± 0.08 (0.008 ± 0.003)	0.50 REF (0.020 REF)	0.75 ± 0.10 (0.030 ± 0.004)	0.25 ± 0.10 (0.010 ± 0.004)

0612 - 4 Element

L	W	T	BW	BL	P	X	S
1.60 ± 0.20 (0.063 ± 0.008)	3.20 ± 0.20 (0.126 ± 0.008)	1.35 MAX (0.053 MAX)	0.41 ± 0.10 (0.016 ± 0.004)	0.18 ^{+0.25} _{-0.08} (0.007 ^{+0.010} _{-0.003})	0.76 REF (0.030 REF)	1.14 ± 0.10 (0.045 ± 0.004)	0.38 ± 0.10 (0.015 ± 0.004)

PAD LAYOUT DIMENSIONS

0508 - 2 Element

A	B	C	D	E
0.68 (0.027)	1.32 (0.052)	2.00 (0.079)	0.46 (0.018)	1.00 (0.039)

0508 - 4 Element

A	B	C	D	E
0.56 (0.022)	1.32 (0.052)	1.88 (0.074)	0.30 (0.012)	0.50 (0.020)

0612 - 4 Element

A	B	C	D	E
0.89 (0.035)	1.65 (0.065)	2.54 (0.100)	0.46 (0.018)	0.76 (0.030)

Low Inductance Capacitors

Introduction

The signal integrity characteristics of a Power Delivery Network (PDN) are becoming critical aspects of board level and semiconductor package designs due to higher operating frequencies, larger power demands, and the ever shrinking lower and upper voltage limits around low operating voltages. These power system challenges are coming from mainstream designs with operating frequencies of 300MHz or greater, modest ICs with power demand of 15 watts or more, and operating voltages below 3 volts.

The classic PDN topology is comprised of a series of capacitor stages. Figure 1 is an example of this architecture with multiple capacitor stages.

An ideal capacitor can transfer all its stored energy to a load instantly. A real capacitor has parasitics that prevent instantaneous transfer of a capacitor's stored energy. The true nature of a capacitor can be modeled as an RLC equivalent circuit. For most simulation purposes, it is possible to model the characteristics of a real capacitor with one

capacitor, one resistor, and one inductor. The RLC values in this model are commonly referred to as equivalent series capacitance (ESC), equivalent series resistance (ESR), and equivalent series inductance (ESL).

The ESL of a capacitor determines the speed of energy transfer to a load. The lower the ESL of a capacitor, the faster that energy can be transferred to a load. Historically, there has been a tradeoff between energy storage (capacitance) and inductance (speed of energy delivery). Low ESL devices typically have low capacitance. Likewise, higher capacitance devices typically have higher ESLs. This tradeoff between ESL (speed of energy delivery) and capacitance (energy storage) drives the PDN design topology that places the fastest low ESL capacitors as close to the load as possible. Low Inductance MLCCs are found on semiconductor packages and on boards as close as possible to the load.

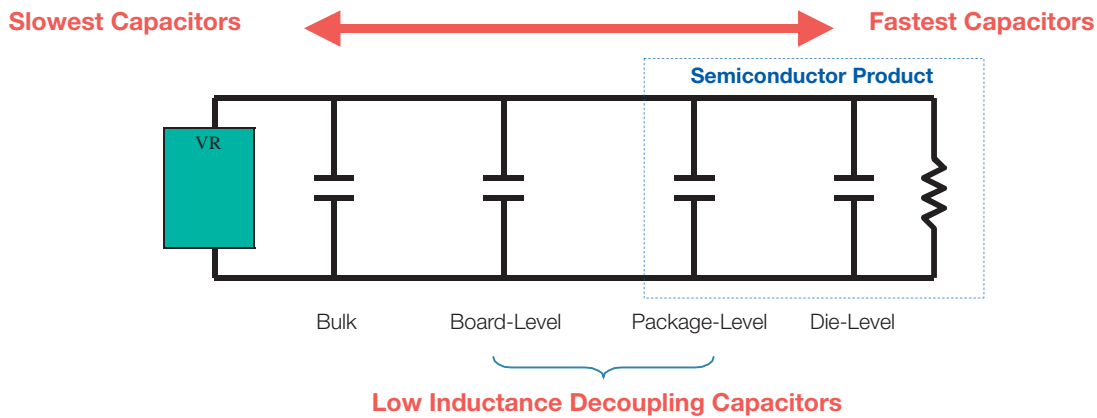

Figure 1 Classic Power Delivery Network (PDN) Architecture

LOW INDUCTANCE CHIP CAPACITORS

The key physical characteristic determining equivalent series inductance (ESL) of a capacitor is the size of the current loop it creates. The smaller the current loop, the lower the ESL. A standard surface mount MLCC is rectangular in shape with electrical terminations on its shorter sides. A Low Inductance Chip Capacitor (LICC) sometimes referred to as Reverse Geometry Capacitor (RGC) has its terminations on the longer side of its rectangular shape.

When the distance between terminations is reduced, the size of the current loop is reduced. Since the size of the current loop is the primary driver of inductance, an 0306 with a smaller current loop has significantly lower ESL than an 0603. The reduction in ESL varies by EIA size, however, ESL is typically reduced 60% or more with an LICC versus a standard MLCC.

INTERDIGITATED CAPACITORS

The size of a current loop has the greatest impact on the ESL characteristics of a surface mount capacitor. There is a secondary method for decreasing the ESL of a capacitor. This secondary method uses adjacent opposing current loops to reduce ESL. The InterDigitated Capacitor (IDC) utilizes both primary and secondary methods of reducing inductance. The IDC architecture shrinks the distance between terminations to minimize the current loop size, then further reduces inductance by creating adjacent opposing current loops.

An IDC is one single capacitor with an internal structure that has been optimized for low ESL. Similar to standard MLCC versus LICCs, the reduction in ESL varies by EIA case size. Typically, for the same EIA size, an IDC delivers an ESL that is at least 80% lower than an MLCC.

Low Inductance Capacitors

Introduction

LAND GRID ARRAY (LGA) CAPACITORS

Land Grid Array (LGA) capacitors are based on the first Low ESL MLCC technology created to specifically address the design needs of current day Power Delivery Networks (PDNs). This is the 3rd low inductance capacitor technology developed by AVX. LGA technology provides engineers with new options. The LGA internal structure and manufacturing technology eliminates the historic need for a device to be physically small to create small current loops to minimize inductance.

The first family of LGA products are 2 terminal devices. A 2 terminal 0306 LGA delivers ESL performance that is equal to or better than an 0306 8 terminal IDC. The 2 terminal 0805 LGA delivers ESL performance that approaches the 0508 8 terminal IDC. New designs that would have used 8 terminal IDCs are moving to 2 terminal LGAs because the layout is easier for a 2 terminal device and manufacturing yield is better for a 2 terminal LGA versus an 8 terminal IDC.

LGA technology is also used in a 4 terminal family of products that AVX is sampling and will formerly introduce in 2008. Beyond 2008, there are new multi-terminal LGA product families that will provide even more attractive options for PDN designers.

LOW INDUCTANCE CHIP ARRAYS (LICA®)

The LICA® product family is the result of a joint development effort between AVX and IBM to develop a high performance MLCC family of decoupling capacitors. LICA was introduced in the 1980s and remains the leading choice of designers in high performance semiconductor packages and high reliability board level decoupling applications.

LICA® products are used in 99.999% uptime semiconductor package applications on both ceramic and organic substrates. The C4 solder ball termination option is the perfect compliment to flip-chip packaging technology. Mainframe class CPUs, ultimate performance multi-chip modules, and communications systems that must have the reliability of 5 9's use LICA®.

LICA® products with either Sn/Pb or Pb-free solder balls are used for decoupling in high reliability military and aerospace applications. These LICA® devices are used for decoupling of large pin count FPGAs, ASICs, CPUs, and other high power ICs with low operating voltages.

When high reliability decoupling applications require the very lowest ESL capacitors, LICA® products are the best option.

470 nF 0306 Impedance Comparison

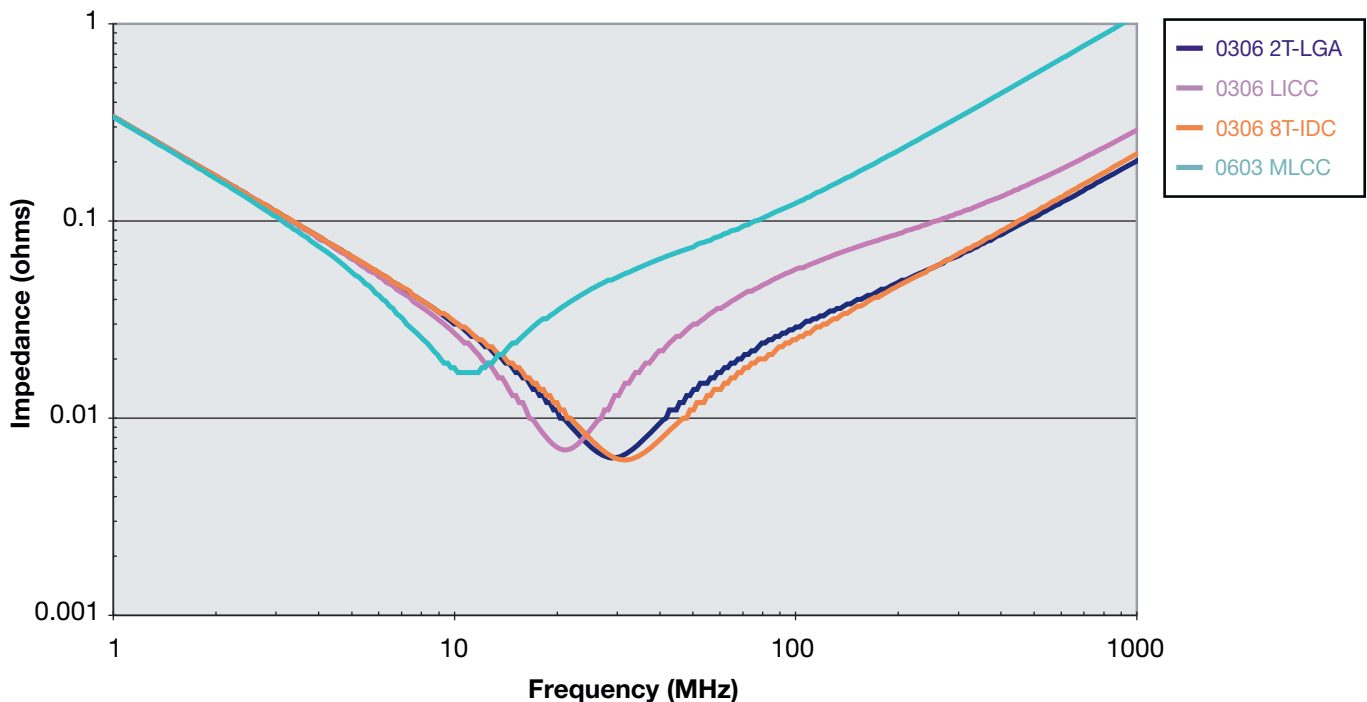

Figure 2 MLCC, LICC, IDC, and LGA technologies deliver different levels of equivalent series inductance (ESL).

Low Inductance Ceramic Capacitors LICC

0306/0508/0612 RoHS Compliant

GENERAL DESCRIPTION

The key physical characteristic determining equivalent series inductance (ESL) of a capacitor is the size of the current loop it creates. The smaller the current loop, the lower the ESL.

A standard surface mount MLCC is rectangular in shape with electrical terminations on its shorter sides. A Low Inductance Chip Capacitor (LICC) sometimes referred to as Reverse Geometry Capacitor (RGC) has its terminations on the longer sides of its rectangular shape. The image on the right shows the termination differences between an MLCC and an LICC.

When the distance between terminations is reduced, the size of the current loop is reduced. Since the size of the current loop is the primary driver of inductance, an 0306 with a smaller current loop has significantly lower ESL than an 0603. The reduction in ESL varies by EIA size, however, ESL is typically reduced 60% or more with an LICC versus a standard MLCC.

AVX LICC products are available with a lead-free finish of plated Nickel/Tin.

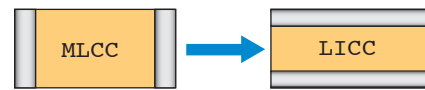
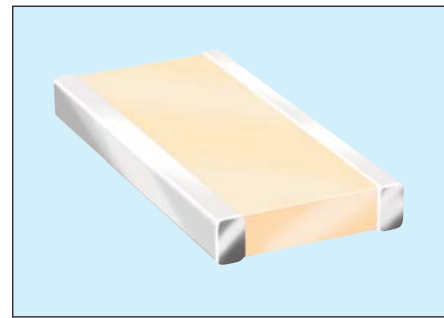

PERFORMANCE CHARACTERISTICS

Capacitance Tolerances	K = $\pm 10\%$; M = $\pm 20\%$
Operation Temperature Range	X7R = -55°C to $+125^{\circ}\text{C}$ X5R = -55°C to $+85^{\circ}\text{C}$ X7S = -55°C to $+125^{\circ}\text{C}$
Temperature Coefficient	X7R, X5R = $\pm 15\%$; X7S = $\pm 22\%$
Voltage Ratings	4, 6.3, 10, 16, 25 VDC
Dissipation Factor	4V, 6.3V = 6.5% max; 10V = 5.0% max; 16V = 3.5% max; 25V = 3.0% max
Insulation Resistance (@+25°C, RVDC)	100,000M Ω min, or 1,000M Ω per μF min., whichever is less



HOW TO ORDER

0612

Size
0306
0508
0612

Z

Voltage
4 = 4V
6 = 6.3V
Z = 10V
Y = 16V
3 = 25V
5 = 50V

D

Dielectric
C = X7R
D = X5R
W = X6S
Z = X7S

105

Capacitance Code (In pF)
2 Sig. Digits +
Number of Zeros

M

Capacitance Tolerance
K = $\pm 10\%$
M = $\pm 20\%$

A

Failure Rate
A = N/A

T

Terminations
T = Plated Ni
and Sn

2

Packaging Available
2 = 7" Reel
4 = 13" Reel

A*

Thickness
Thickness
mm (in)
0.56 (0.022)
0.76 (0.030)
1.02 (0.040)
1.27 (0.050)

*See the thickness tables on the next page.

NOTE: Contact factory for availability of Termination and Tolerance Options for Specific Part Numbers.

TYPICAL IMPEDANCE CHARACTERISTICS

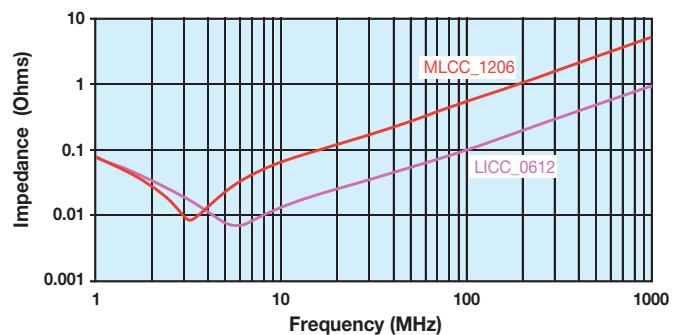
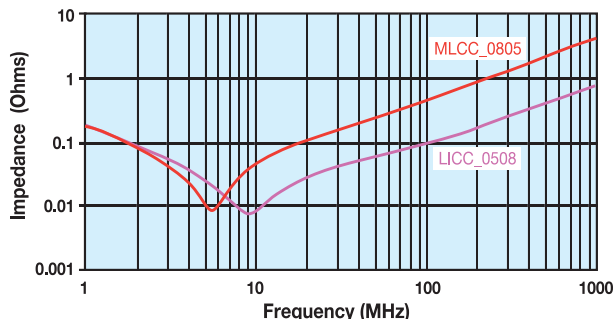

Low Inductance Ceramic Capacitors LICC

0306/0508/0612 RoHS Compliant

SIZE		0306					0508					0612				
Packaging		Embossed					Embossed					Embossed				
Length	mm (in.)	0.81 ± 0.15 (0.032 ± 0.006)					1.27 ± 0.25 (0.050 ± 0.010)					1.60 ± 0.25 (0.063 ± 0.010)				
Width	mm (in.)	1.60 ± 0.15 (0.063 ± 0.006)					2.00 ± 0.25 (0.080 ± 0.010)					3.20 ± 0.25 (0.126 ± 0.010)				
Cap Code	WVDC4	4	6.3	10	16	25	6.3	10	16	25	50	6.3	10	16	25	50
102	Cap 0.001	A	A	A	A	S	S	S	S	V	S	S	S	S	V	
222	(µF) 0.0022	A	A	A	A	S	S	S	S	V	S	S	S	S	V	
332	0.0033	A	A	A	A	S	S	S	S	V	S	S	S	S	V	
472	0.0047	A	A	A	A	S	S	S	S	V	S	S	S	S	V	
682	0.0068	A	A	A	A	S	S	S	S	V	S	S	S	S	V	
103	0.01	A	A	A	A	S	S	S	S	V	S	S	S	S	V	
153	0.015	A	A	A	A	S	S	S	S	V	S	S	S	S	W	
223	0.022	A	A	A	A	S	S	S	S	V	S	S	S	S	W	
333	0.033	A	A	A		S	S	S	V	V	S	S	S	S	W	
473	0.047	A	A	A		S	S	S	V	A	S	S	S	S	W	
683	0.068	A	A	A		S	S	S	A	A	S	S	S	V	W	
104	0.1	A	A	A		S	S	V	A	A	S	S	S	V	W	
154	0.15	A	A			S	S	V			S	S	S	W	W	
224	0.22	A	A			S	S	A			S	S	V	W		
334	0.33					V	V	A			S	S	V			
474	0.47					V	V	A			S	S	V			
684	0.68					A	A				V	V	W			
105	1	A				A	A				V	V	A			
155	1.5										W	W				
225	2.2										A	A				
335	3.3										A					
475	4.7															
685	6.8															
106	10															

PHYSICAL DIMENSIONS AND PAD LAYOUT

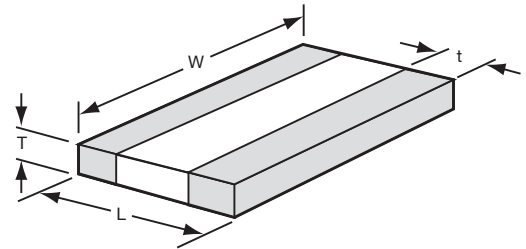

PHYSICAL DIMENSIONS

	mm (in)		
	L	W	t
0306	0.81 ± 0.15 (0.032 ± 0.006)	1.60 ± 0.15 (0.063 ± 0.006)	0.13 min. (0.005 min.)
0508	1.27 ± 0.25 (0.050 ± 0.010)	2.00 ± 0.25 (0.080 ± 0.010)	0.13 min. (0.005 min.)
0612	1.60 ± 0.25 (0.063 ± 0.010)	3.20 ± 0.25 (0.126 ± 0.010)	0.13 min. (0.005 min.)

T - See Range Chart for Thickness and Codes

PAD LAYOUT DIMENSIONS

	mm (in)		
	A	B	C
0306	0.31 (0.012)	1.52 (0.060)	0.51 (0.020)
0508	0.51 (0.020)	2.03 (0.080)	0.76 (0.030)
0612	0.76 (0.030)	3.05 (0.120)	0.635 (0.025)

Solid = X7R = X5R = X7S = X6S

mm (in.)	
Code	Thickness
A	0.56 (0.022)

mm (in.)	
Code	Thickness
S	0.56 (0.022)
V	0.76 (0.030)
A	1.02 (0.040)

mm (in.)	
Code	Thickness
S	0.56 (0.022)
V	0.76 (0.030)
W	1.02 (0.040)
A	1.27 (0.050)

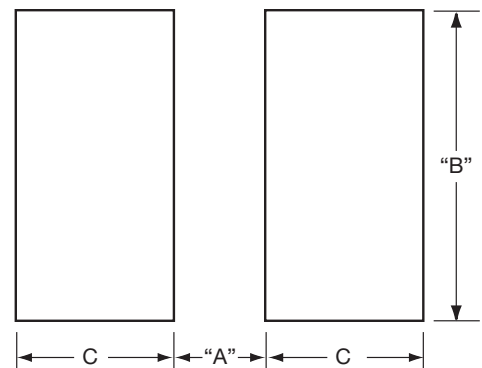

Low Inductance Capacitors with SnPb Terminations

LD16/LD17/LD18 Tin-Lead Termination "B"

GENERAL DESCRIPTION

The key physical characteristic determining equivalent series inductance (ESL) of a capacitor is the size of the current loop it creates. The smaller the current loop, the lower the ESL.

A standard surface mount MLCC is rectangular in shape with electrical terminations on its shorter sides. A Low Inductance Chip Capacitor (LICC) sometimes referred to as Reverse Geometry Capacitor (RGC) has its terminations on the longer sides of its rectangular shape. The image on the right shows the termination differences between an MLCC and an LICC.

When the distance between terminations is reduced, the size of the current loop is reduced. Since the size of the current loop is the primary driver of inductance, an 0306 with a smaller current loop has significantly lower ESL than an 0603. The reduction in ESL varies by EIA size, however, ESL is typically reduced 60% or more with an LICC versus a standard MLCC.

AVX LICC products are available with a lead termination for high reliability military and aerospace applications that must avoid tin whisker reliability issues.

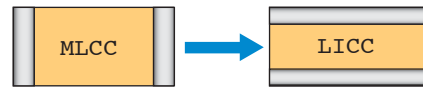
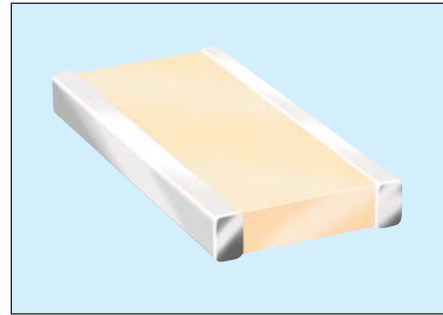

PERFORMANCE CHARACTERISTICS

Capacitance Tolerances	K = $\pm 10\%$; M = $\pm 20\%$
Operation Temperature Range	X7R = -55°C to $+125^{\circ}\text{C}$ X5R = -55°C to $+85^{\circ}\text{C}$ X7S = -55°C to $+125^{\circ}\text{C}$
Temperature Coefficient	X7R, X5R = $\pm 15\%$; X7S = $\pm 22\%$
Voltage Ratings	4, 6.3, 10, 16, 25 VDC
Dissipation Factor	4V, 6.3V = 6.5% max; 10V = 5.0% max; 16V = 3.5% max; 25V = 3.0% max
Insulation Resistance (@+25°C, RVDC)	100,000M Ω min, or 1,000M Ω per μF min., whichever is less

Not RoHS Compliant

HOW TO ORDER

LD18	Z	D	105	M	A	B	2	A*
Size LD16 = 0306 LD17 = 0508 LD18 = 0612	Voltage 4 = 4V 6 = 6.3V Z = 10V Y = 16V 3 = 25V 5 = 50V	Dielectric C = X7R D = X5R W = X6S	Capacitance Code (In pF) 2 Sig. Digits + Number of Zeros	Capacitance Tolerance K = $\pm 10\%$ M = $\pm 20\%$	Failure Rate A = N/A	Terminations B = 5% min lead	Packaging Available 2 = 7" Reel 4 = 13" Reel	Thickness Thickness mm (in) 0.56 (0.022) 0.76 (0.030) 1.02 (0.040) 1.27 (0.050)

*See the thickness tables on the next page.

NOTE: Contact factory for availability of Termination and Tolerance Options for Specific Part Numbers.

TYPICAL IMPEDANCE CHARACTERISTICS

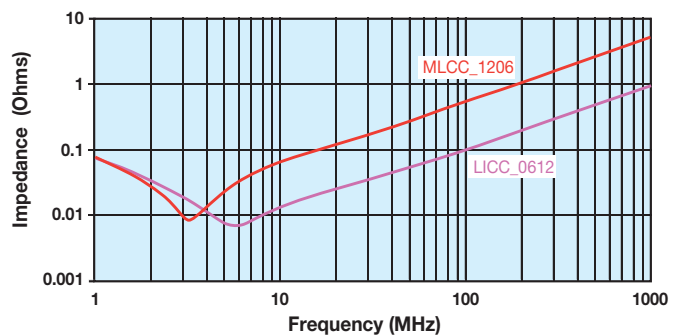
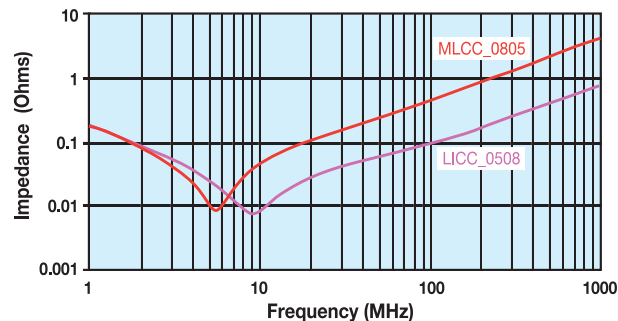

Low Inductance Capacitors with SnPb Terminations

LD16/LD17/LD18 Tin-Lead Termination "B"

SIZE		LD16 (0306)				LD17 (0508)					LD18 (0612)				
Packaging		Embossed				Embossed					Embossed				
Length	mm (in.)	0.81 ± 0.15 (0.032 ± 0.006)				1.27 ± 0.25 (0.050 ± 0.010)					1.60 ± 0.25 (0.063 ± 0.010)				
Width	mm (in.)	1.60 ± 0.15 (0.063 ± 0.006)				2.00 ± 0.25 (0.080 ± 0.010)					3.20 ± 0.25 (0.126 ± 0.010)				
Cap Code	WVDC	6.3	10	16	25	6.3	10	16	25	50	6.3	10	16	25	50
102	Cap 0.001	A	A	A	A	S	S	S	S	V	S	S	S	S	V
222	(µF) 0.0022	A	A	A	A	S	S	S	S	V	S	S	S	S	V
332	0.0033	A	A	A	A	S	S	S	S	V	S	S	S	S	V
472	0.0047	A	A	A	A	S	S	S	S	V	S	S	S	S	V
682	0.0068	A	A	A	A	S	S	S	S	V	S	S	S	S	V
103	0.01	A	A	A	A	S	S	S	S	V	S	S	S	S	V
153	0.015	A	A	A	A	S	S	S	S	V	S	S	S	S	W
223	0.022	A	A	A	A	S	S	S	S	V	S	S	S	S	W
333	0.033	A	A	A		S	S	S	V	V	S	S	S	S	W
473	0.047	A	A	A		S	S	S	V	A	S	S	S	S	W
683	0.068	A	A	A		S	S	S	A	A	S	S	S	V	W
104	0.1	A	A	X		S	S	V	A	A	S	S	S	V	W
154	0.15	A	A			S	S	V			S	S	S	W	W
224	0.22	A	A			S	S	A			S	S	V	W	
334	0.33					V	V	A			S	S	V		
474	0.47					V	V	X			S	S	V		
684	0.68					A	A				V	V	W		
105	1					A	A				V	V	A		
155	1.5			X							W	W			
225	2.2										A	A			
335	3.3										A				
475	4.7														
685	6.8														
106	10														

PHYSICAL DIMENSIONS AND PAD LAYOUT

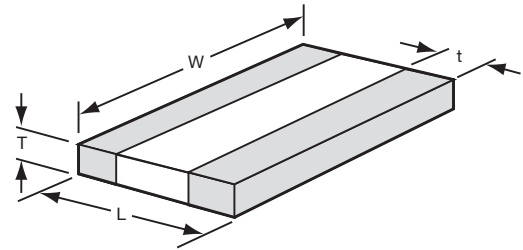

PHYSICAL DIMENSIONS

	mm (in)		
	L	W	t
LD16 (0306)	0.81 ± 0.15 (0.032 ± 0.006)	1.60 ± 0.15 (0.063 ± 0.006)	0.13 min. (0.005 min.)
LD17 (0508)	1.27 ± 0.25 (0.050 ± 0.010)	2.00 ± 0.25 (0.080 ± 0.010)	0.13 min. (0.005 min.)
LD18 (0612)	1.60 ± 0.25 (0.063 ± 0.010)	3.20 ± 0.25 (0.126 ± 0.010)	0.13 min. (0.005 min.)

T - See Range Chart for Thickness and Codes

PAD LAYOUT DIMENSIONS

	mm (in)		
	A	B	C
LD16 (0306)	0.31 (0.012)	1.52 (0.060)	0.51 (0.020)
LD17 (0508)	0.51 (0.020)	2.03 (0.080)	0.76 (0.030)
LD18 (0612)	0.76 (0.030)	3.05 (0.120)	0.635 (0.025)

Solid = X7R

X = X5R

X = X6S

mm (in.)	
LD16 (0306)	
Code	Thickness
A	0.56 (0.022)

mm (in.)	
LD17 (0508)	
Code	Thickness
S	0.56 (0.022)
V	0.76 (0.030)
A	1.02 (0.040)

mm (in.)	
LD18 (0612)	
Code	Thickness
S	0.56 (0.022)
V	0.76 (0.030)
W	1.02 (0.040)
A	1.27 (0.050)

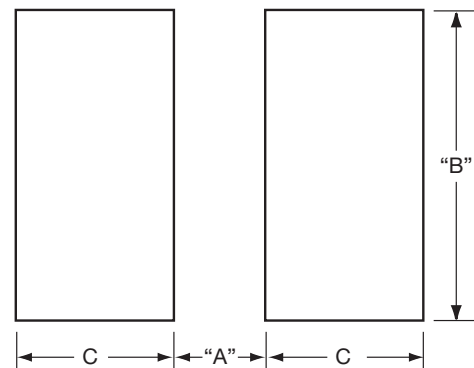

IDC Low Inductance Capacitors (RoHS)

0306/0612/0508 IDC (InterDigitated Capacitors)

GENERAL DESCRIPTION

Inter-Digitated Capacitors (IDCs) are used for both semiconductor package and board level decoupling. The equivalent series inductance (ESL) of a single capacitor or an array of capacitors in parallel determines the response time of a Power Delivery Network (PDN). The lower the ESL of a PDN, the faster the response time. A designer can use many standard MLCCs in parallel to reduce ESL or a low ESL Inter-Digitated Capacitor (IDC) device. These IDC devices are available in versions with a maximum height of 0.95mm or 0.55mm.

IDCs are typically used on packages of semiconductor products with power levels of 15 watts or greater. Inter-Digitated Capacitors are used on CPU, GPU, ASIC, and ASSP devices produced on 0.13μ, 90nm, 65nm, and 45nm processes. IDC devices are used on both ceramic and organic package substrates. These low ESL surface mount capacitors can be placed on the bottom side or the top side of a package substrate. The low profile 0.55mm maximum height IDCs can easily be used on the bottom side of BGA packages or on the die side of packages under a heat spreader.

IDCs are used for board level decoupling of systems with speeds of 300MHz or greater. Low ESL IDCs free up valuable board space by reducing the number of capacitors required versus standard MLCCs. There are additional benefits to reducing the number of capacitors beyond saving board space including higher reliability from a reduction in the number of components and lower placement costs based on the need for fewer capacitors.

The Inter-Digitated Capacitor (IDC) technology was developed by AVX. This is the second family of Low Inductance MLCC products created by AVX. IDCs are a cost effective alternative to AVX's first generation low ESL family for high-reliability applications known as LICA (Low Inductance Chip Array).

AVX IDC products are available with a lead-free finish of plated Nickel/Tin.

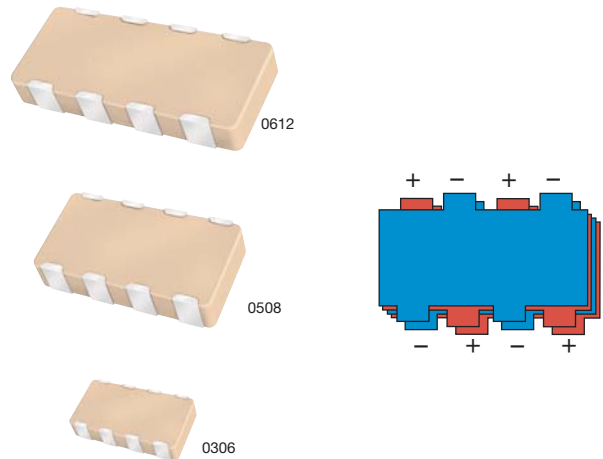

TYPICAL IMPEDANCE

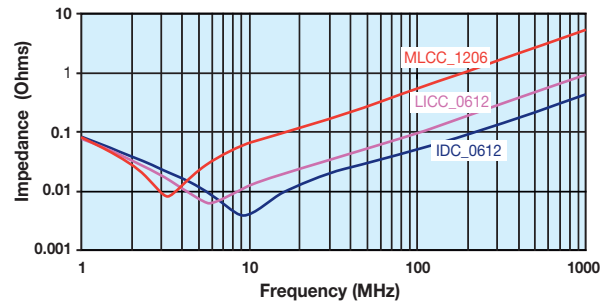

HOW TO ORDER

W	3	L	1	6	D	225	M	A	T	3	A
Style	IDC Case Size	Low Inductance	Number of Terminals	Voltage	Dielectric	Capacitance Code (In pF)	Capacitance Tolerance	Failure Rate	Termination	Packaging	Thickness
	2 = 0508 3 = 0612 4 = 0306		1 = 8 Terminals	4 = 4V 6 = 6.3V Z = 10V Y = 16V 3 = 25V	C = X7R D = X5R Z = X7S	2 Sig. Digits + Number of Zeros	M = ±20%	A = N/A	T = Plated Ni and Sn	Available 1=7" Reel 3=13" Reel	Max. Thickness mm (in.) A=Standard S=0.55 (0.022)

NOTE: Contact factory for availability of Termination and Tolerance Options for Specific Part Numbers.

PERFORMANCE CHARACTERISTICS

Capacitance Tolerance	±20% Preferred
Operation Temperature Range	X7R = -55°C to +125°C X5R = -55°C to +85°C X7S = -55°C to +125°C
Temperature Coefficient	±15% (0VDC), ±22% (X7S)
Voltage Ratings	4, 6.3, 10, 16, 25 VDC
Dissipation Factor	≤ 6.3V = 6.5% max; 10V = 5.0% max; ≥ 16V = 3.5% max
Insulation Resistance (@+25°C, RVDC)	100,000MΩ min, or 1,000MΩ per μF min., whichever is less

Dielectric Strength	No problems observed after 2.5 x RVDC for 5 seconds at 50mA max current
CTE (ppm/C)	12.0
Thermal Conductivity	4-5W/M K
Terminations Available	Plated Nickel and Solder

IDC Low Inductance Capacitors (RoHS)

0306/0612/0508 IDC (InterDigitated Capacitors)

SIZE	W4 = 0306		W2 = Thin 0508			W2 = 0508			W3= Thin 0612				W3 = 0612					W3 = THICK 0612							
Max. Thickness (mm) (in.)	0.55 (0.022)		0.55 (0.022)			0.95 (0.037)			0.55 (0.022)				0.95 (0.037)					1.22 (0.048)							
WVDC	4	6.3	4	6.3	10	16	25	4	6.3	10	16	25	4	6.3	10	16	4	6.3	10	16	25	4	6.3	10	16
Cap (μF)	This table content is a grid of colored cells representing availability. The colors are: Brown (X7R), Red (X5R), and Cyan (X7S).																								
0.010	Cyan		Brown																						
0.022	Cyan		Brown																						
0.033	Cyan		Brown																						
0.047	Cyan		Brown																						
0.068	Cyan		Brown																						
0.10	Cyan		Brown																						
0.22	Cyan		Brown																						
0.33	Cyan		Brown																						
0.47	Cyan		Brown																						
0.68	Cyan		Red		Brown																				
1.0	Cyan		Cyan		Brown																				
1.5	Cyan		Cyan		Red		Brown																		
2.2	Cyan		Cyan		Red		Brown																		
3.3	Cyan		Cyan		Red		Brown																		

PHYSICAL DIMENSIONS AND PAD LAYOUT

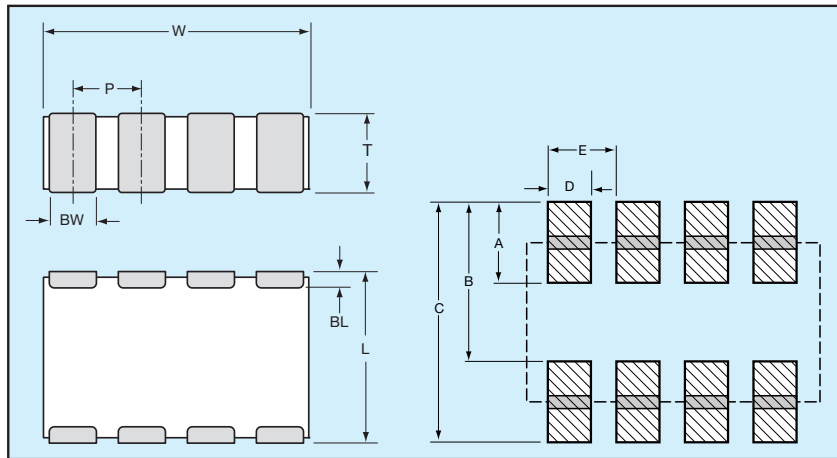

Consult factory for additional requirements

- = X7R
- = X5R
- = X7S

PHYSICAL CHIP DIMENSIONS millimeters (inches)

SIZE	W	L	BW	BL	P
0306	1.60 ± 0.20 (0.063 ± 0.008)	0.82 ± 0.10 (0.032 ± 0.006)	0.25 ± 0.10 (0.010 ± 0.004)	0.20 ± 0.10 (0.008 ± 0.004)	0.40 ± 0.05 (0.015 ± 0.002)
0508	2.03 ± 0.20 (0.080 ± 0.008)	1.27 ± 0.20 (0.050 ± 0.008)	0.30 ± 0.10 (0.012 ± 0.004)	0.25 ± 0.15 (0.010 ± 0.006)	0.50 ± 0.05 (0.020 ± 0.002)
0612	3.20 ± 0.20 (0.126 ± 0.008)	1.60 ± 0.20 (0.063 ± 0.008)	0.50 ± 0.10 (0.020 ± 0.004)	0.25 ± 0.15 (0.010 ± 0.006)	0.80 ± 0.10 (0.031 ± 0.004)

PAD LAYOUT DIMENSIONS

SIZE	A	B	C	D	E
0306	0.38 (0.015)	0.89 (0.035)	1.27 (0.050)	0.20 (0.008)	0.40 (0.015)
0508	0.64 (0.025)	1.27 (0.050)	1.91 (0.075)	0.28 (0.011)	0.50 (0.020)
0612	0.89 (0.035)	1.65 (0.065)	2.54 (0.100)	0.45 (0.018)	0.80 (0.031)

IDC Low Inductance Capacitors (SnPb)

0306/0612/0508 IDC with Sn/Pb Termination

GENERAL DESCRIPTION

Inter-Digitated Capacitors (IDCs) are used for both semiconductor package and board level decoupling. The equivalent series inductance (ESL) of a single capacitor or an array of capacitors in parallel determines the response time of a Power Delivery Network (PDN). The lower the ESL of a PDN, the faster the response time. A designer can use many standard MLCCs in parallel to reduce ESL or a low ESL Inter-Digitated Capacitor (IDC) device. These IDC devices are available in versions with a maximum height of 0.95mm or 0.55mm.

IDCs are typically used on packages of semiconductor products with power levels of 15 watts or greater. Inter-Digitated Capacitors are used on CPU, GPU, ASIC, and ASSP devices produced on 0.13 μ m, 90nm, 65nm, and 45nm processes. IDC devices are used on both ceramic and organic package substrates. These low ESL surface mount capacitors can be placed on the bottom side or the top side of a package substrate. The low profile 0.55mm maximum height IDCs can easily be used on the bottom side of BGA packages or on the die side of packages under a heat spreader.

IDCs are used for board level decoupling of systems with speeds of 300MHz or greater. Low ESL IDCs free up valuable board space by reducing the number of capacitors required versus standard MLCCs. There are additional benefits to reducing the number of capacitors beyond saving board space including higher reliability from a reduction in the number of components and lower placement costs based on the need for fewer capacitors.

The Inter-Digitated Capacitor (IDC) technology was developed by AVX. This is the second family of Low Inductance MLCC products created by AVX. IDCs are a cost effective alternative to AVX's first generation low ESL family for high-reliability applications known as LICA (Low Inductance Chip Array).

AVX IDC products are available with a lead termination for high reliability military and aerospace applications that must avoid tin whisker reliability issues.

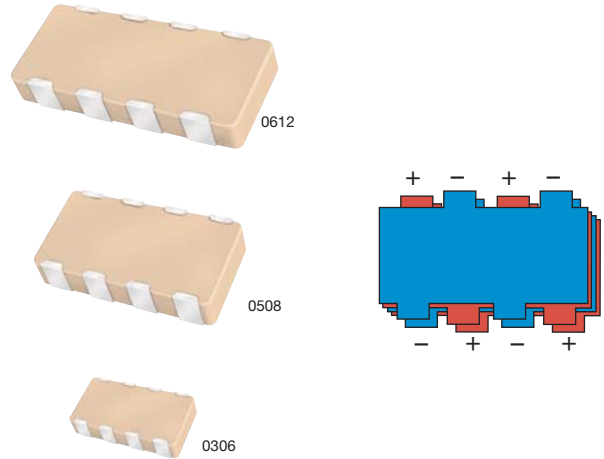

TYPICAL IMPEDANCE

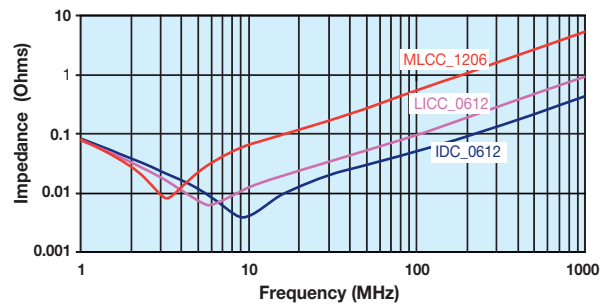

Not RoHS Compliant

HOW TO ORDER

L	3	L	1	6	D	225	M	A	B	3	A
Style	IDC Case Size	Low Inductance	Number of Terminals	Voltage	Dielectric	Capacitance Code (In pF)	Capacitance Tolerance	Failure Rate	Termination	Packaging Available	Thickness
	2 = 0508 3 = 0612 4 = 0306		1 = 8 Terminals	4 = 4V 6 = 6.3V Z = 10V Y = 16V 3 = 25V	C = X7R D = X5R Z = X7S	2 Sig. Digits + Number of Zeros	M = $\pm 20\%$	A = N/A	B = 5% min. Lead	1=7" Reel 3=13" Reel	<u>Max. Thickness</u> mm (in.) A=Standard S=0.55 (0.022)

NOTE: Contact factory for availability of Termination and Tolerance Options for Specific Part Numbers.

PERFORMANCE CHARACTERISTICS

Capacitance Tolerance	$\pm 20\%$ Preferred
Operation Temperature Range	X7R = -55°C to +125°C X5R = -55°C to +85°C X7S = -55°C to +125°C
Temperature Coefficient	$\pm 15\%$ (0VDC), $\pm 22\%$ (X7S)
Voltage Ratings	4, 6.3, 10, 16, 25 VDC
Dissipation Factor	$\leq 6.3V = 6.5\%$ max; 10V = 5.0% max; $\geq 16V = 3.5\%$ max
Insulation Resistance (@+25°C, RVDC)	100,000M Ω min, or 1,000M Ω per μ F min., whichever is less

Dielectric Strength	No problems observed after 2.5 x RVDC for 5 seconds at 50mA max current
CTE (ppm/C)	12.0
Thermal Conductivity	4-5W/M K
Terminations Available	Plated Nickel and Solder

IDC Low Inductance Capacitors (SnPb)

0306/0612/0508 IDC with Sn/Pb Termination

SIZE	W4 = 0306		W2 = Thin 0508					W2 = 0508					W3= Thin 0612				W3 = 0612					W3 = THICK 0612								
Max. Thickness (mm (in.))	0.55 (0.022)		0.55 (0.022)					0.95 (0.037)					0.55 (0.022)				0.95 (0.037)					1.22 (0.048)								
WVDC	4	6.3	4	6.3	10	16	25	4	6.3	10	16	25	4	6.3	10	16	4	6.3	10	16	25	4	6.3	10	16	25	4	6.3	10	16
Cap (μF)	0.010																													
	0.022																													
	0.033																													
	0.047																													
	0.068																													
	0.10																													
	0.22																													
	0.33																													
	0.47																													
	0.68																													
	1.0																													
	1.5																													
	2.2																													
	3.3																													

PHYSICAL DIMENSIONS AND PAD LAYOUT

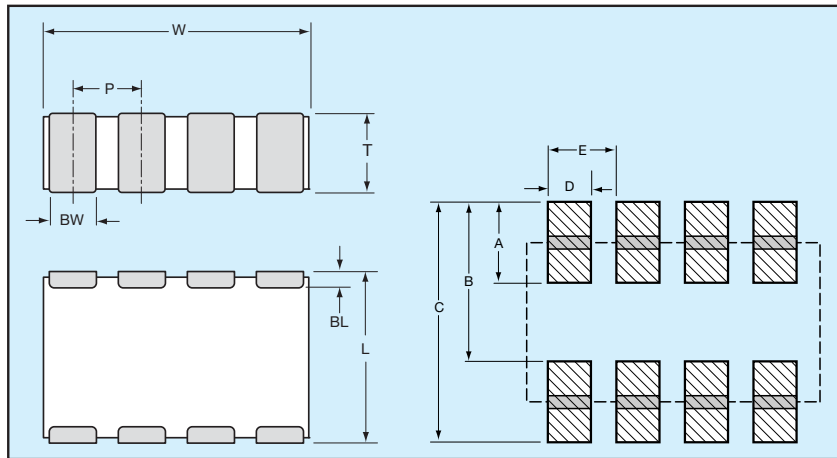

Consult factory for additional requirements

- = X7R
- = X5R
- = X7S

PHYSICAL CHIP DIMENSIONS millimeters (inches)

SIZE	W	L	BW	BL	P
0306	1.60 ± 0.20 (0.063 ± 0.008)	0.82 ± 0.10 (0.032 ± 0.006)	0.25 ± 0.10 (0.010 ± 0.004)	0.20 ± 0.10 (0.008 ± 0.004)	0.40 ± 0.05 (0.015 ± 0.002)
0508	2.03 ± 0.20 (0.080 ± 0.008)	1.27 ± 0.20 (0.050 ± 0.008)	0.30 ± 0.10 (0.012 ± 0.004)	0.25 ± 0.15 (0.010 ± 0.006)	0.50 ± 0.05 (0.020 ± 0.002)
0612	3.20 ± 0.20 (0.126 ± 0.008)	1.60 ± 0.20 (0.063 ± 0.008)	0.50 ± 0.10 (0.020 ± 0.004)	0.25 ± 0.15 (0.010 ± 0.006)	0.80 ± 0.10 (0.031 ± 0.004)

PAD LAYOUT DIMENSIONS

SIZE	A	B	C	D	E
0306	0.38 (0.015)	0.89 (0.035)	1.27 (0.050)	0.20 (0.008)	0.40 (0.015)
0508	0.64 (0.025)	1.27 (0.050)	1.91 (0.075)	0.28 (0.011)	0.50 (0.020)
0612	0.89 (0.035)	1.65 (0.065)	2.54 (0.100)	0.45 (0.018)	0.80 (0.031)

LGA Low Inductance Capacitors

0204/0306 Land Grid Array

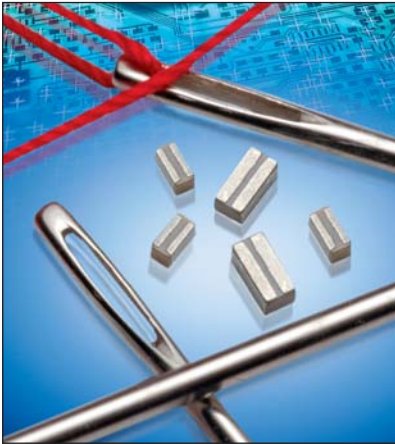

Land Grid Array (LGA) capacitors are the latest family of low inductance MLCCs from AVX. These new LGA products are the third low inductance family developed by AVX. The innovative LGA technology sets a new standard for low inductance MLCC performance.

Our initial 2 terminal versions of LGA technology deliver the performance of an 8 terminal IDC low inductance MLCC with a number of advantages including:

- Simplified layout of 2 large solder pads compared to 8 small pads for IDCs
- Opportunity to reduce PCB or substrate contribution to system ESL by using multiple parallel vias in solder pads
- Advanced FCT manufacturing process used to create uniformly flat terminations on the capacitor that resist “tombstoning”
- Better solder joint reliability

APPLICATIONS

Semiconductor Packages

- Microprocessors/CPUs
- Graphics Processors/GPUs
- Chipsets
- FPGAs
- ASICs

Board Level Device Decoupling

- Frequencies of 300 MHz or more
- ICs drawing 15W or more
- Low voltages
- High speed buses

0306 2 TERMINAL LGA COMPARISON WITH 0306 8 TERMINAL IDC

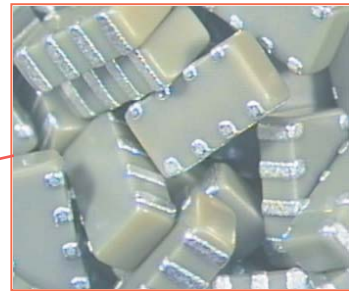
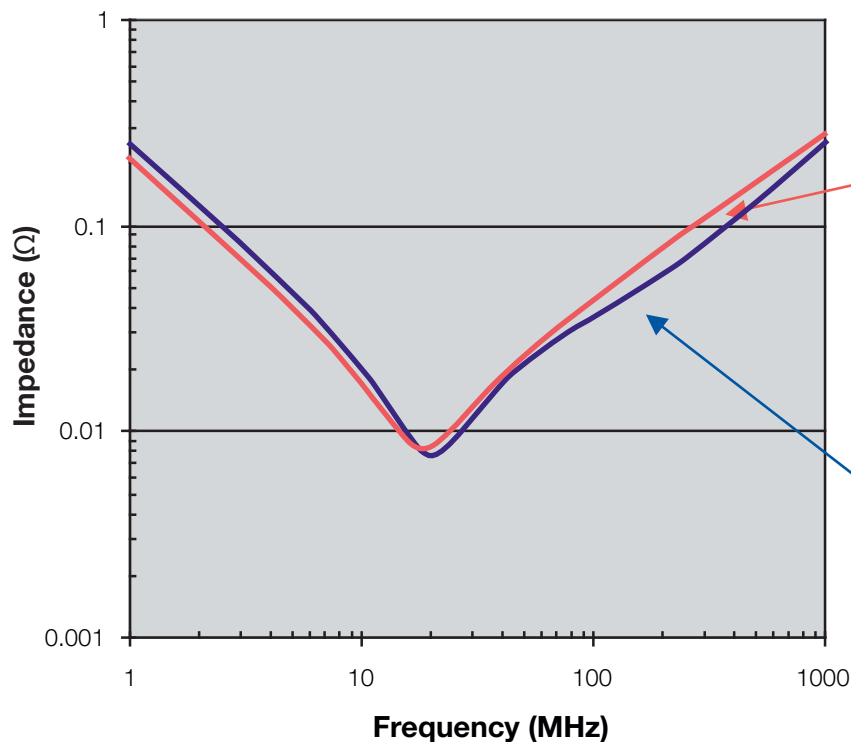

LG A Low Inductance Capacitors

0204/0306 Land Grid Array

SIZE	LG12 (0204)						LG22 (0306)								
Length mm (in.)	0.50 (0.020)						0.76 (0.030)								
Width mm (in.)	1.00 (0.039)						1.60 (0.063)								
Temp. Char.	X5R (D)		X7S (Z)		X6S (W)		X7R (C)		X5R (D)		X7S (Z)		X6S (W)		
Working Voltage	6.3 (6)	4 (4)	6.3 (6)	4 (4)	6.3 (6)	4 (4)	10 (Z)	6.3 (6)	4 (4)	6.3 (6)	4 (4)	6.3 (6)	4 (4)	6.3 (6)	4 (4)
Cap (µF)	0.010 (103)														
	0.022 (223)														
	0.047 (473)														
	0.100 (104)														
	0.220 (224)														
	0.330 (334)														
	0.470 (474)														
	1.000 (105)														
	2.200 (225)														

= X7R
 = X5R
 = X7S
 = X6S

HOW TO ORDER

LG	1	2	6	Z	104	M	A	T	2	S	1
Style	Case Size	Number of Terminals	Working Voltage	Temperature Characteristic	Coded Cap	Cap Tolerance	Termination Style	Termination	Packaging Tape & Reel	Thickness	Number of Capacitors
	1 = 0204 2 = 0306	2	4 = 4V 6 = 6.3V Z = 10V	C = X7R D = X5R Z = X7S W = X6S		M = 20%	A = "U" Land	100% Sn* <small>*Contact factory for other termination finishes</small>	2 = 7" Reel 4 = 13" Reel	S = 0.55mm max	

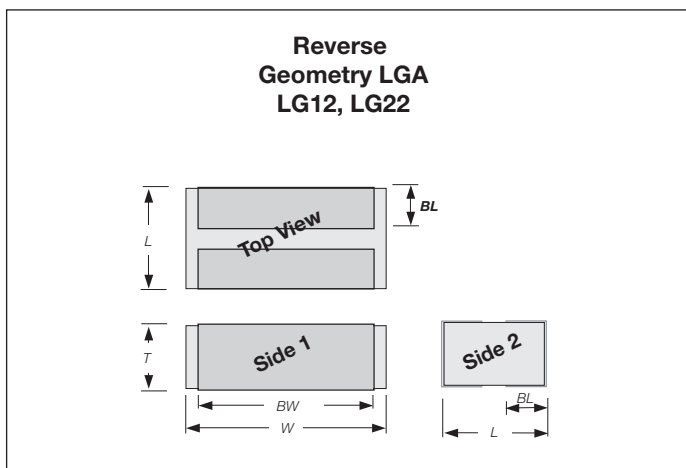

PART DIMENSIONS

Series	L	W	T	BW	BL
LG12 (0204)	0.5 ± 0.05 (0.020 ± 0.002)	1.00 ± 0.10 (0.039 ± 0.004)	0.50 ± 0.05 (0.020 ± 0.002)	0.8 ± 0.10 (0.031 ± 0.004)	0.13 ± 0.08 (0.005 ± 0.003)
LG22 (0306)	0.76 ± 0.10 (0.030 ± 0.004)	1.60 ± 0.10 (0.063 ± 0.004)	0.50 ± 0.05 (0.020 ± 0.002)	1.50 ± 0.10 (0.059 ± 0.004)	0.28 ± 0.08 (0.011 ± 0.003)

mm (inches)



RECOMMENDED SOLDER PAD DIMENSIONS

Series	PL	PW1	G
LG12 (0204)	0.50 (0.020)	1.00 (0.039)	0.20 (0.008)
LG22 (0306)	0.65 (0.026)	1.50 (0.059)	0.20 (0.008)

mm (inches)

LGA Low Inductance Capacitors

0204/0306 Land Grid Array – Tin/Lead Termination “B”

SIZE	PG12 (0204)						PG22 (0306)								
Length mm (in.)	0.50 (0.020)						0.76 (0.030)								
Width mm (in.)	1.00 (0.039)						1.60 (0.063)								
Temp. Char.	X5R (D)		X7S (Z)		X6S (W)		X7R (C)		X5R (D)		X7S (Z)		X6S (W)		
Working Voltage	6.3 (6)	4 (4)	6.3 (6)	4 (4)	6.3 (6)	4 (4)	10 (Z)	6.3 (6)	4 (4)	6.3 (6)	4 (4)	6.3 (6)	4 (4)	6.3 (6)	4 (4)
Cap (µF)	0.010 (103)														

= X7R
 = X5R
 = X7S
 = X6S

HOW TO ORDER

PG	1	2	6	Z	104	M	A	B	2	S	1
Style	Case Size	Number of Terminals	Working Voltage	Temperature Characteristic	Coded Cap	Cap Tolerance	Termination Style	Termination	Packaging Tape & Reel	Thickness	Number of Capacitors
	1 = 0204 2 = 0306	2	4 = 4V 6 = 6.3V Z = 10V	C = X7R D = X5R Z = X7S W = X6S		M = 20%	A = "U" Land	5% Min Lead	2 = 7" Reel 4 = 13" Reel	S = 0.55mm max	

Not RoHS Compliant

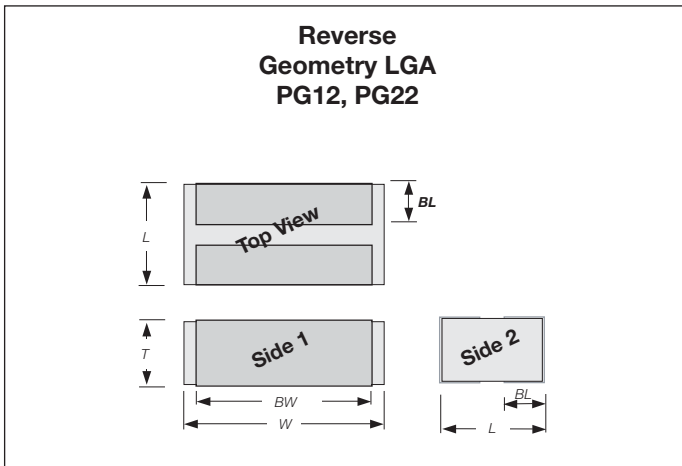

PART DIMENSIONS

Series	L	W	T	BW	BL
PG12 (0204)	0.5 ± 0.05 (0.020 ± 0.002)	1.00 ± 0.10 (0.039 ± 0.004)	0.50 ± 0.05 (0.020 ± 0.002)	0.8 ± 0.10 (0.031 ± 0.004)	0.13 ± 0.08 (0.005 ± 0.003)
PG22 (0306)	0.76 ± 0.10 (0.030 ± 0.004)	1.60 ± 0.10 (0.063 ± 0.004)	0.50 ± 0.05 (0.020 ± 0.002)	1.50 ± 0.10 (0.059 ± 0.004)	0.28 ± 0.08 (0.011 ± 0.003)

RECOMMENDED SOLDER PAD DIMENSIONS

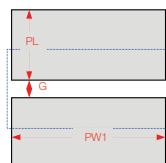

Series	PL	PW1	G
PG12 (0204)	0.50 (0.020)	1.00 (0.039)	0.20 (0.008)
PG22 (0306)	0.65 (0.026)	1.50 (0.059)	0.20 (0.008)

Low Inductance Capacitors

LICA® (Low Inductance Decoupling Capacitor Arrays)



LICA® arrays utilize up to four separate capacitor sections in one ceramic body (see Configurations and Capacitance Options). These designs exhibit a number of technical advancements:

Low Inductance features–

- Low resistance platinum electrodes in a low aspect ratio pattern
- Double electrode pickup and perpendicular current paths
- C4 “flip-chip” technology for minimal interconnect inductance

HOW TO ORDER

LICA	3	T	102	M	3	F	C	4	A	A
Style & Size	5V = 9 10V = Z 25V = 3	D = X5R T = T55T S = High K T55T	Cap/Section (EIA Code) 102 = 1000 pF 103 = 10 nF 104 = 100 nF	Capacitance Tolerance M = ±20% P = GMV	Height Code 6 = 0.500mm 3 = 0.650mm 1 = 0.875mm 5 = 1.100mm 7 = 1.600mm	Termination F = C4 Solder Balls- 97Pb/3Sn H = C4 Solder Balls Low ESR G = Lead Free SAC R = Cr-Cu-Au N = Cr-Ni-Au V = Eutectic Lead-Tin Bump- 37%Pb/63%Sn X = None	Reel Packaging M = 7" Reel R = 13" Reel 6 = 2"x2" Waffle Pack 8 = 2"x2" Black Waffle Pack 7 = 2"x2" Waffle Pack w/ termination facing up A = 2"x2" Black Waffle Pack w/ termination facing up C = 4"x4" Waffle Pack w/ clear lid	# of Caps/Part 1 = one 2 = two 4 = four	Inspection Code A = Standard B = COTS+ X = MIL-PRF-123	Code Face A = Bar B = No Bar C = Dot, S55S Dielectrics D = Triangle

NOTE: Contact factory for availability of Termination and Tolerance Options for Specific Part Numbers.

TABLE 1

Typical Parameters	T55T/S55S	Units
Capacitance, 25°C	Co	Nanofarads
Capacitance, 55°C	1.45 x Co	Nanofarads
Capacitance, 85°C	0.7 x Co	Nanofarads
Dissipation Factor 25°	15	Percent
ESR (Nominal)	20	Milliohms
DC Resistance	0.2	Ohms
IR (Minimum @25°) (Design Dependent)	300	Megaohms
Dielectric Breakdown, Min	500	Volts
Thermal Coefficient of Expansion	8.5	ppm/°C 25-100°
Inductance: (Design Dependent) (Nominal)	30	Pico-Henries
Frequency of Operation	DC to 5 Gigahertz	
Ambient Temp Range	-55° to 125°C	



SOLDER BALL AND PAD DIMENSIONS

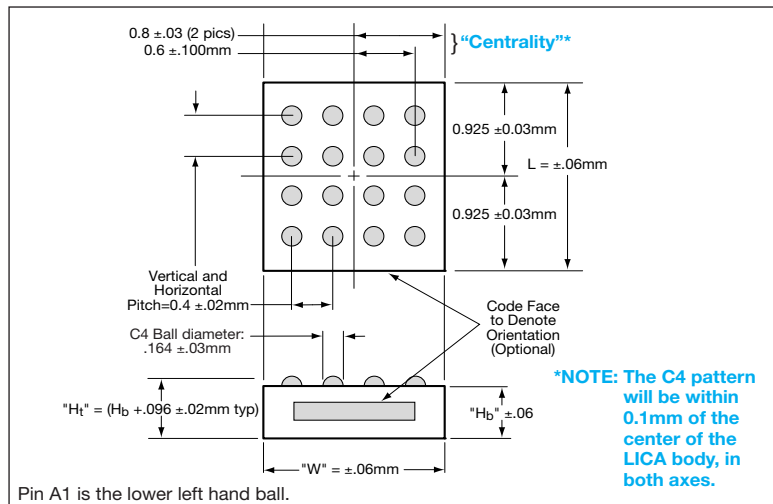

Pin A1 is the lower left hand ball.

Code (Body Height)	Width (W)	Length (L)	Height Body (H _b)
1	1.600mm	1.850mm	0.875mm
3	1.600mm	1.850mm	0.650mm
5	1.600mm	1.850mm	1.100mm
6	1.600mm	1.850mm	0.500mm
7	1.600mm	1.850mm	1.600mm

TERMINATION OPTIONS

SOLDER BALLS
TERMINATION OPTION F, H, G OR V

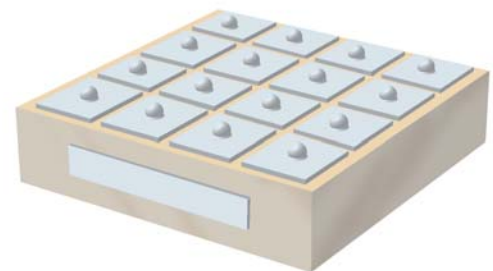

TERMINATION OPTION R OR N

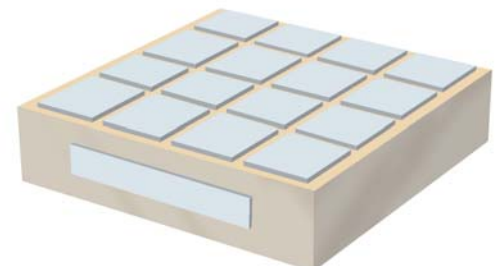

Low Inductance Capacitors

LICA® (Low Inductance Decoupling Capacitor Arrays)

TEMPERATURE VS CAPACITANCE CHANGE

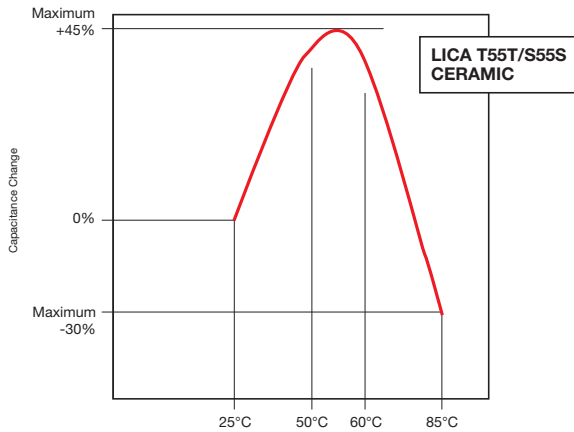

TYPICAL S21 FOR LICA AT SINGLE VIA

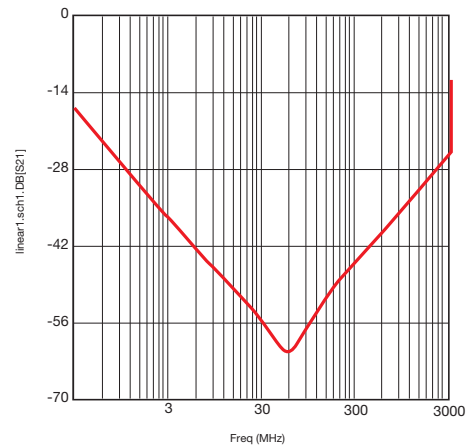

LICA COMMON PART NUMBER LIST

Part Number	Voltage	Thickness (mm)	Capacitors per Package
LICA3T193M3FC4AA	25	0.650	4
LICA3T153P3FC4AA	25	0.650	4
LICA3T134M1FC1AA	25	0.875	1
LICA3T104P1FC1AA	25	0.875	1
LICA3T333M1FC4AA	25	0.875	4
LICA3T263P3FC4AA	25	0.650	4
LICA3T244M5FC1AA	25	1.100	1
LICA3T194P5FC1AA	25	1.100	1
LICA3T394M7FC1AB	25	1.600	1
LICA3T314P7FC1AB	25	1.600	1
Extended Range			
LICAZT623M3FC4AB	10	0.650	4
LICA3T104M3FC1A	25	0.650	1
LICA3T803P3FC1A	25	0.650	1
LICA3T423M3FC2A	25	0.650	2
LICA3T333P3FC2A	25	0.650	2
LICA3S253M3FC4A	25	0.650	4
LICAZD753M3FC4AD	10	0.650	4
LICAZD504M3FC1AB	10	0.650	1
LICAZD604M7FC1AB	10	1.600	1
LICA3D193M3FC4AB	25	0.650	4

CONFIGURATION

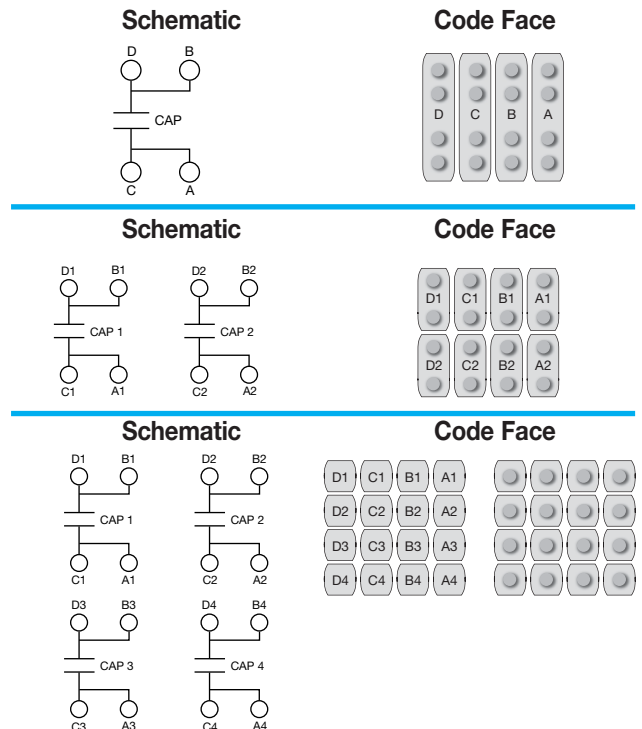

WAFFLE PACK OPTIONS FOR LICA®

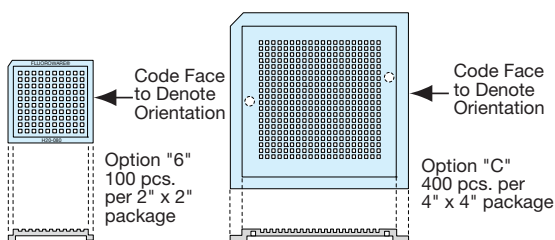

Note: Standard configuration is Termination side down

LICA® PACKAGING SCHEME "M" AND "R"

8mm conductive plastic tape on reel:
 "M"=7" reel max. qty. 3,000, "R"=13" reel max. qty. 8,000

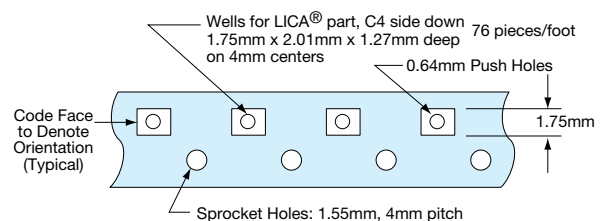

AT Series

High Temperature MLCC – 200°C & 250°C Rated

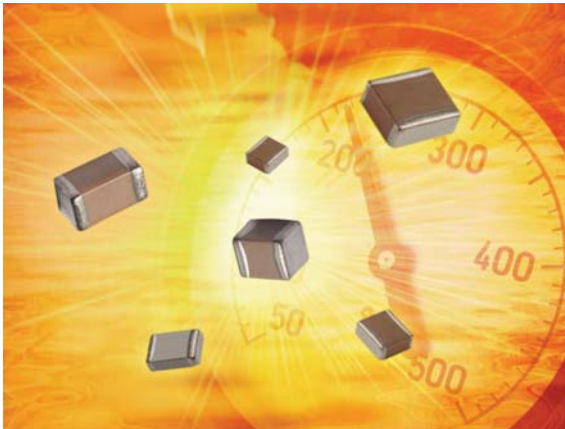

Present military specifications, as well as a majority of commercial applications, require a maximum operating temperature of 125°C. However, the emerging market for high temperature electronics demands capacitors operating reliably at temperatures beyond 125°C. AVX's new high temperature chip capacitor product line, with verified capability of long-term operation up to 250°C is a response to both military and commercial business needs. The new capacitors demonstrate high current handling capabilities, high volumetric efficiency, high insulation resistance and low ESR/ESL. This product has been designed for the most demanding applications, such as "down-hole" oil exploration and aerospace programs.

HOW TO ORDER

AT10	3	T	104	K	A	T	2	A
AVX Style	Voltage Code	Temperature Coefficient	Capacitance Code (2 significant digits + no. of zeros)	Capacitance Tolerance	Test Level	Termination	Packaging	Special Code
AT03 = 0603 AT05 = 0805 AT06 = 1206 AT10 = 1210 AT12 = 1812 AT14 = 2225	16V = Y 25V = 3 50V = 5	COG 250°C = A COG 200°C = 2 VHT 250°C = T VHT 200°C = 4	101 = 100pF 102 = 1nF 103 = 10nF 104 = 100nF 105 = 1µF	J = ±5% K = ±10% M = ±20%	A = Standard	1 = Pd/Ag T = 100% Sn Plated (RoHS Compliant)	2 = 7" Reel 4 = 13" Reel 9 = Bulk	A = Standard

ELECTRICAL SPECIFICATIONS

Temperature Coefficient

COG: A 0±30 ppm/°C, -55°C to +250°C
VHT: T ±15%, -55°C to +150°C
See TCC Plot for +250°C

Capacitance Test (MIL-STD-202, Method 305)
25°C, 1.0 ± 0.2 Vrms (open circuit voltage) @ 1kHz

Dissipation factor 25°C

COG: 0.15% Max at 1.0 ± 0.2 Vrms (open circuit voltage) @ 1kHz
VHT: 2.5% Max at 1.0 ± 0.2 Vrms (open circuit voltage) @ 1kHz

Insulation Resistance 25°C (MIL-STD-202, Method 302)
100GΩ or 1000MΩ.µF (whichever is less)

Insulation Resistance 125°C (MIL-STD-202, Method 302)
10GΩ or 100MΩ.µF (whichever is less)

Insulation Resistance 200°C (MIL-STD-202, Method 302)
1GΩ or 10MΩ.µF (whichever is less)

Insulation Resistance 250°C (MIL-STD-202, Method 302)
100MΩ or 1MΩ.µF (whichever is less)

Direct Withstanding Voltage 25°C (Flash Test)

250% rated voltage for 5 seconds with 50mA max charging current
(500 Volt units @ 750VDC)

DIMENSIONS

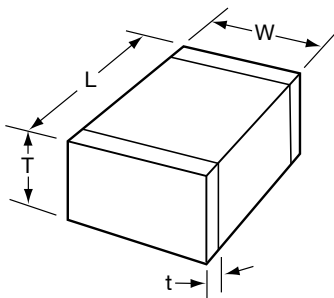

millimeters (inches)

Size	AT03 = 0603	AT05 = 0805	AT06 = 1206	AT10 = 1210	AT12 = 1812	AT14 = 2225
(L) Length	1.60 ± 0.15 (0.063 ± 0.006)	2.01 ± 0.20 (0.079 ± 0.008)	3.20 ± 0.20 (0.126 ± 0.008)	3.20 ± 0.20 (0.126 ± 0.008)	4.50 ± 0.30 (0.177 ± 0.012)	5.72 ± 0.25 (0.225 ± 0.010)
(W) Width	0.81 ± 0.15 (0.032 ± 0.006)	1.25 ± 0.20 (0.049 ± 0.008)	1.60 ± 0.20 (0.063 ± 0.008)	2.50 ± 0.20 (0.098 ± 0.008)	3.20 ± 0.20 (0.126 ± 0.008)	6.35 ± 0.25 (0.250 ± 0.010)
(T) Thickness Max.	1.02 (0.040)	1.30 (0.051)	1.52 (0.060)	1.70 (0.067)	2.54 (0.100)	2.54 (0.100)
(t) terminal min. max.	0.25 (0.010) 0.75 (0.030)	0.25 (0.010) 0.75 (0.030)	0.25 (0.010) 0.75 (0.030)	0.25 (0.010) 0.75 (0.030)	0.25 (0.010) 1.02 (0.040)	0.25 (0.010) 1.02 (0.040)

AT Series

High Temperature MLCC – 200°C & 250°C Rated

PERFORMANCE CHARACTERISTICS

Typical Temperature Coefficient of Capacitance (VHT Dielectric)

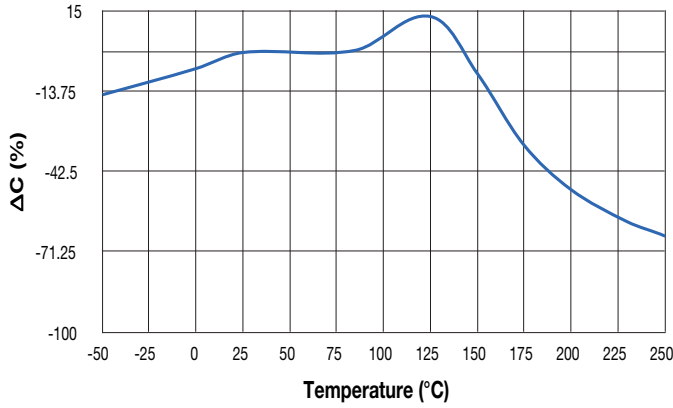

Typical Temperature Coefficient of Capacitance (COG Dielectric)

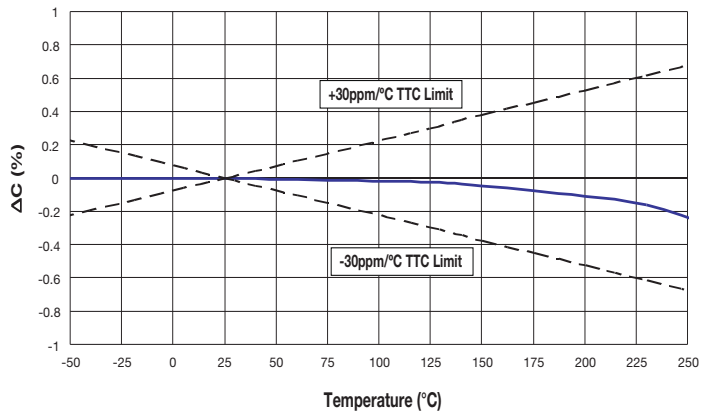

Typical Voltage Coefficient of Capacitance (VHT Dielectric)

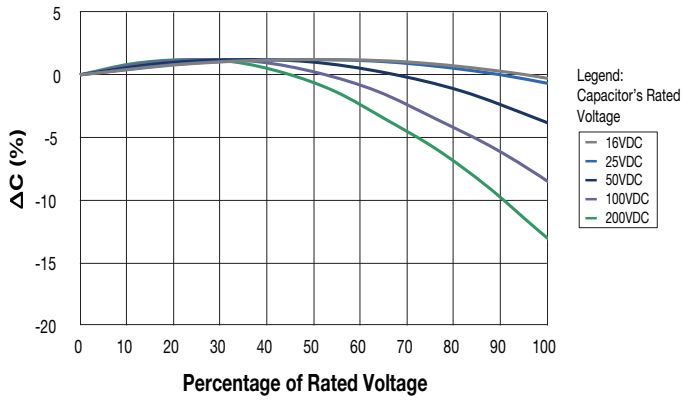

Typical Voltage Coefficient of Capacitance (COG Dielectric)

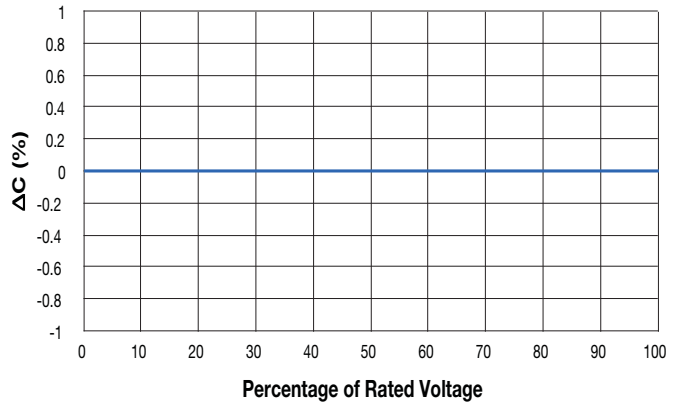

Typical RC vs Temperature (VHT Dielectric)

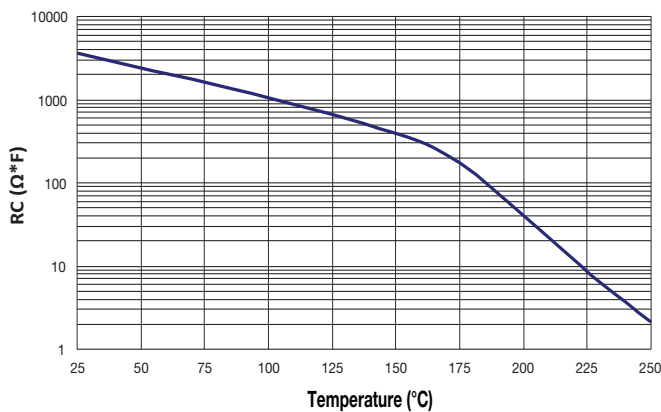

Typical RC vs Temperature (COG Dielectric)

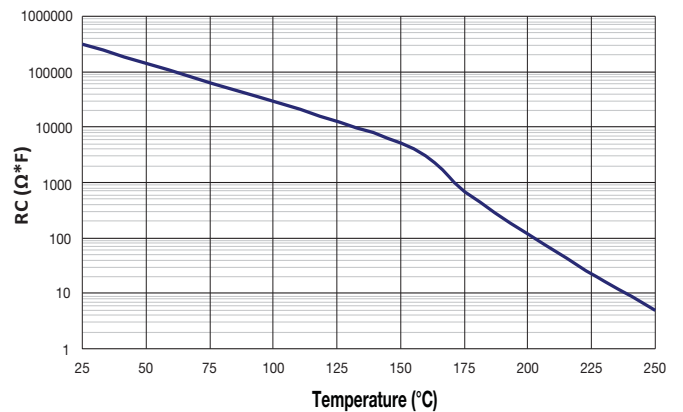

AT Series

High Temperature MLCC – 200°C & 250°C Rated

RELIABILITY

250°C Life Test @ 2x Rated Voltage (VHT Dielectric)

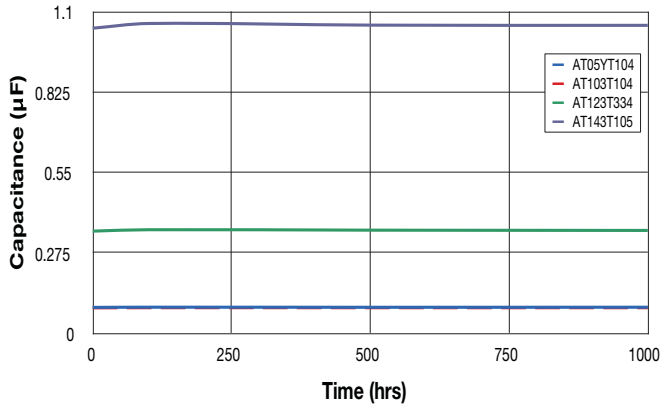

250°C Life Test @ 2x Rated Voltage (C0G Dielectric)

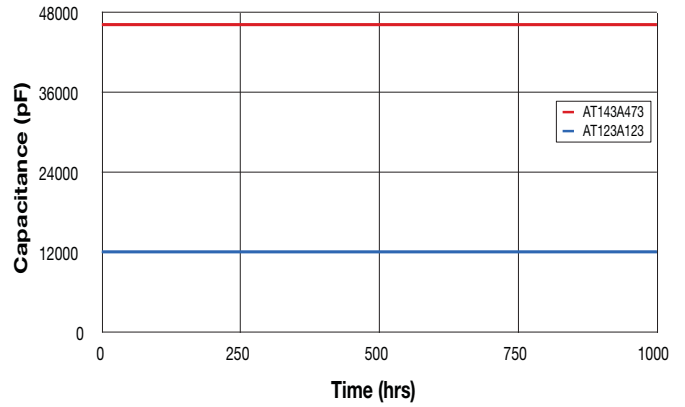

VHT - Failure Rate @ 90% Confidence Level (%/1000 hours)		
Temperature (°C)	50% Rated Voltage	100% Rated Voltage
200	0.002	0.017
250	0.026	0.210

*Typical 1210, 1812, 2225 Failure Rate Analysis based on 250°C testing and voltage ratings specified on the following page.

C0G - Failure Rate @ 90% Confidence Level (%/1000 hours)		
Temperature (°C)	50% Rated Voltage	100% Rated Voltage
200	0.006	0.047
250	0.074	0.590

*Typical 1812 and 2225 Failure Rate Analysis based on 250°C testing and voltage ratings specified on the following page.

FREQUENCY RESPONSE

Impedance Frequency Response (VHT Dielectric)

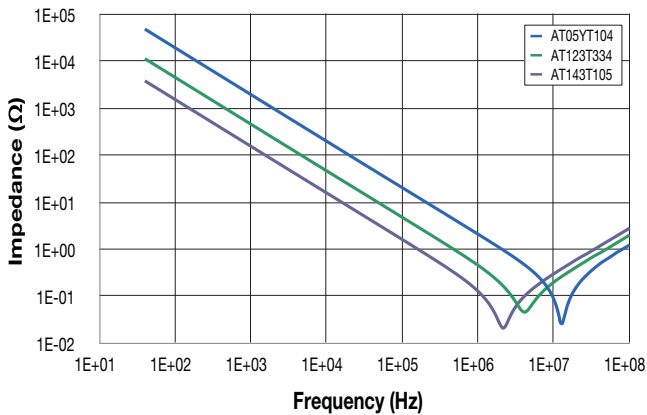

Impedance Frequency Response (C0G Dielectric)

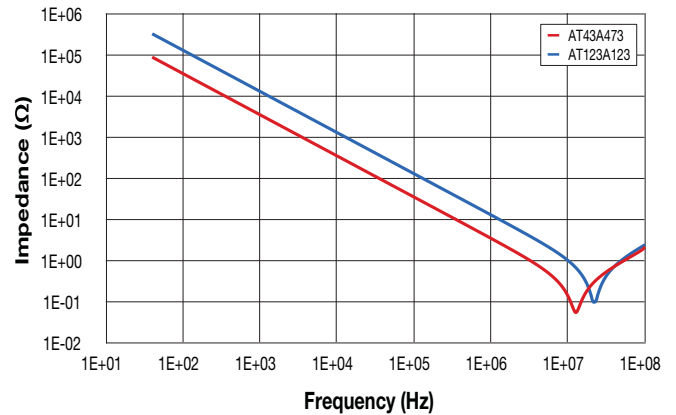

ESR Frequency Response (VHT Dielectric)

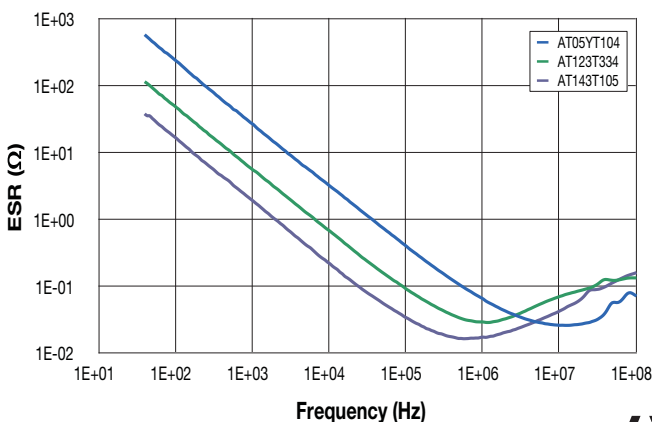

ESR Frequency Response (C0G Dielectric)

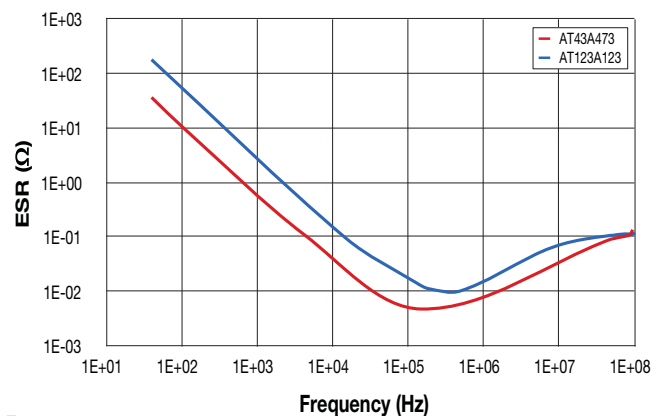

AT Series

High Temperature MLCC – 200°C & 250°C Rated

CAPACITANCE RANGE PREFERRED SIZES ARE SHADED

VHT Temp. Coefficient: 4 200°C Rated

Case Size	AT03 = 0603		AT05 = 0805		AT06 = 1206		AT10 = 1210		AT12 = 1812		AT14 = 2225	
Soldering	Reflow/Wave		Reflow/Wave		Reflow/Wave		Reflow Only		Reflow Only		Reflow Only	
(L) Length	1.60 ± 0.15 (0.063 ± 0.006)		2.01 ± 0.20 (0.079 ± 0.008)		3.20 ± 0.20 (0.126 ± 0.008)		3.20 ± 0.20 (0.126 ± 0.008)		4.50 ± 0.30 (0.177 ± 0.012)		5.72 ± 0.25 (0.225 ± 0.010)	
(W) Width	0.81 ± 0.15 (0.032 ± 0.006)		1.25 ± 0.20 (0.049 ± 0.008)		1.60 ± 0.20 (0.063 ± 0.008)		2.50 ± 0.20 (0.098 ± 0.008)		3.20 ± 0.20 (0.126 ± 0.008)		6.35 ± 0.25 (0.250 ± 0.010)	
(T) Thickness	1.02 (0.040)		1.30 (0.051)		1.52 (0.060)		1.70 (0.067)		2.54 (0.100)		2.54 (0.100)	
(l) Terminal	min 0.25 (0.010) max 0.75 (0.030)		min 0.25 (0.010) max 0.75 (0.030)		min 0.25 (0.010) max 0.75 (0.030)		min 0.25 (0.010) max 0.75 (0.030)		min 0.25 (0.010) max 1.02 (0.040)		min 0.25 (0.010) max 1.02 (0.040)	
Rated Temp. (°C)	200		200		200		200		200		200	
Temp. Coefficient	4		4		4		4		4		4	
Voltage (V)	25		25 50		25 50		25 50		50		50	
Cap (pF)	1000	102										
	1200	122										
	1500	152										
	1800	182										
	2200	222										
	2700	272										
	3300	332										
	3900	392										
	4700	472										
	5600	562										
	6800	682										
	8200	822										
Cap (µF)	0.010	103										
	0.012	123										
	0.015	153										
	0.018	183										
	0.022	223										
	0.027	273										
	0.033	333										
	0.039	393										
	0.047	473										
	0.056	563										
	0.068	683										
	0.082	823										
	0.100	104										
	0.120	124										
	0.150	154										
	0.180	184										
	0.220	224										
	0.270	274										
	0.330	334										
	0.390	394										
	0.470	474										
	0.560	564										
	0.680	684										
	0.820	824										
	1.000	105										
Voltage (V)	25		25 50		25 50		25 50		50		50	
Rated Temp. (°C)	200		200		200		200		200		200	
Case Size	AT03 = 0603		AT05 = 0805		AT06 = 1206		AT10 = 1210		AT12 = 1812		AT14 = 2225	

Voltage rating per table. Capacitance values specified at 25°C, derate capacitance value based on TCC and VCC Plots on page 2.

NOTE: Contact factory for non-specified capacitance values.

AT Series

High Temperature MLCC – 200°C & 250°C Rated

CAPACITANCE RANGE

PREFERRED SIZES ARE SHADED

VHT Temp. Coefficient: T 250°C Rated

Case Size	AT03 = 0603		AT05 = 0805		AT06 = 1206		AT10 = 1210		AT12 = 1812		AT14 = 2225	
Soldering	Reflow/Wave		Reflow/Wave		Reflow/Wave		Reflow Only		Reflow Only		Reflow Only	
(L) Length	mm	1.60 ± 0.15	2.01 ± 0.20	3.20 ± 0.20	3.20 ± 0.20	4.50 ± 0.30	5.72 ± 0.25					
	(in.)	(0.063 ± 0.006)	(0.079 ± 0.008)	(0.126 ± 0.008)	(0.126 ± 0.008)	(0.177 ± 0.012)	(0.225 ± 0.010)					
(W) Width	mm	0.81 ± 0.15	1.25 ± 0.20	1.60 ± 0.20	2.50 ± 0.20	3.20 ± 0.20	6.35 ± 0.25					
	(in.)	(0.032 ± 0.006)	(0.049 ± 0.008)	(0.063 ± 0.008)	(0.098 ± 0.008)	(0.126 ± 0.008)	(0.250 ± 0.010)					
(T) Thickness	mm	1.02	1.30	1.52	1.70	2.54	2.54					
	(in.)	(0.040)	(0.051)	(0.060)	(0.067)	(0.100)	(0.100)					
(l) Terminal	min	0.25 (0.010)	0.25 (0.010)	0.25 (0.010)	0.25 (0.010)	0.25 (0.010)	0.25 (0.010)					
	max	0.75 (0.030)	0.75 (0.030)	0.75 (0.030)	0.75 (0.030)	1.02 (0.040)	1.02 (0.040)					
Rated Temp. (°C)	250		250		250		250		250		250	
Temp. Coefficient	T		T		T		T		T		T	
Voltage (V)	16		16 25		16 25		16 25		25		25	
Cap (pF)	1000	102										
	1200	122										
	1500	152										
	1800	182										
	2200	222										
	2700	272										
	3300	332										
	3900	392										
	4700	472										
	5600	562										
	6800	682										
	8200	822										
Cap (µF)	0.010	103										
	0.012	123										
	0.015	153										
	0.018	183										
	0.022	223										
	0.027	273										
	0.033	333										
	0.039	393										
	0.047	473										
	0.056	563										
	0.068	683										
	0.082	823										
	0.100	104										
	0.120	124										
	0.150	154										
	0.180	184										
	0.220	224										
	0.270	274										
	0.330	334										
	0.390	394										
	0.470	474										
	0.560	564										
	0.680	684										
	0.820	824										
	1.000	105										
Voltage (V)	16		16 25		16 25		16 25		25		25	
Rated Temp. (°C)	250		250		250		250		250		250	
Case Size	AT03 = 0603		AT05 = 0805		AT06 = 1206		AT10 = 1210		AT12 = 1812		AT14 = 2225	

Voltage rating per table. Capacitance values specified at 25°C, derate capacitance value based on TCC and VCC Plots on page 2.

NOTE: Contact factory for non-specified capacitance values.

AT Series

High Temperature MLCC – 200°C & 250°C Rated

CAPACITANCE RANGE PREFERRED SIZES ARE SHADED

COG Temp. Coefficient: 2 200°C Rated

Case Size	AT05 = 0805	AT06 = 1206	AT10 = 1210	AT12 = 1812	AT14 = 2225
Soldering	Reflow/Wave	Reflow/Wave	Reflow Only	Reflow Only	Reflow Only
(L) Length mm (in.)	2.01 ± 0.20 (0.079 ± 0.008)	3.20 ± 0.20 (0.126 ± 0.008)	3.20 ± 0.20 (0.126 ± 0.008)	4.50 ± 0.30 (0.177 ± 0.012)	2.75 ± 0.25 (0.225 ± 0.010)
(W) Width mm (in.)	1.25 ± 0.20 (0.049 ± 0.008)	1.60 ± 0.20 (0.063 ± 0.008)	2.50 ± 0.20 (0.098 ± 0.008)	3.20 ± 0.20 (0.126 ± 0.008)	6.35 ± 0.25 (0.250 ± 0.010)
(T) Thickness mm (in.)	1.30 (0.051)	1.52 (0.060)	1.70 (0.067)	2.54 (0.100)	2.54 (0.100)
(t) Terminal min max	0.25 (0.010) 0.75 (0.030)	0.25 (0.010) 0.75 (0.030)	0.25 (0.010) 0.75 (0.030)	0.25 (0.010) 1.02 (0.040)	0.25 (0.010) 1.02 (0.040)
Rated Temp. (°C)	200	200	200	200	200
Temp. Coefficient	2	2	2	2	2
Voltage (V)	50	50	50	50	50
Cap (pF)	100 101				
	120 121				
	150 151				
	180 181				
	220 221				
	270 271				
	330 331				
	390 391				
	470 471				
	560 561				
	680 681				
	820 821				
	1000 102				
	1200 122				
	1500 152				
	1800 182				
	2200 222				
	2700 272				
	3300 332				
	3900 392				
	4700 472				
	5600 562				
	6800 682				
	8200 822				
Cap (µF)	0.010 103				
	0.012 123				
	0.015 153				
	0.018 183				
	0.022 223				
	0.027 273				
	0.033 333				
	0.039 393				
	0.047 473				
	0.056 563				
	0.068 683				
	0.082 823				
	0.100 104				
Voltage (V)	50	50	50	50	50
Rated Temp. (°C)	200	200	200	200	200
Case Size	AT05 = 0805	AT06 = 1206	AT10 = 1210	AT12 = 1812	AT14 = 2225

COG Temp. Coefficient: A 250°C Rated

Case Size	AT05 = 0805	AT06 = 1206	AT10 = 1210	AT12 = 1812	AT14 = 2225
Soldering	Reflow/Wave	Reflow/Wave	Reflow Only	Reflow Only	Reflow Only
(L) Length mm (in.)	2.01 ± 0.20 (0.079 ± 0.008)	3.20 ± 0.20 (0.126 ± 0.008)	3.20 ± 0.20 (0.126 ± 0.008)	4.50 ± 0.30 (0.177 ± 0.012)	2.75 ± 0.25 (0.225 ± 0.010)
(W) Width mm (in.)	1.25 ± 0.20 (0.049 ± 0.008)	1.60 ± 0.20 (0.063 ± 0.008)	2.50 ± 0.20 (0.098 ± 0.008)	3.20 ± 0.20 (0.126 ± 0.008)	6.35 ± 0.25 (0.250 ± 0.010)
(T) Thickness mm (in.)	1.30 (0.051)	1.52 (0.060)	1.70 (0.067)	2.54 (0.100)	2.54 (0.100)
(t) Terminal min max	0.25 (0.010) 0.75 (0.030)	0.25 (0.010) 0.75 (0.030)	0.25 (0.010) 0.75 (0.030)	0.25 (0.010) 1.02 (0.040)	0.25 (0.010) 1.02 (0.040)
Rated Temp. (°C)	250	250	250	250	250
Temp. Coefficient	A	A	A	A	A
Voltage (V)	25	25	25	25	25
Cap (pF)	100 101				
	120 121				
	150 151				
	180 181				
	220 221				
	270 271				
	330 331				
	390 391				
	470 471				
	560 561				
	680 681				
	820 821				
	1000 102				
	1200 122				
	1500 152				
	1800 182				
	2200 222				
	2700 272				
	3300 332				
	3900 392				
	4700 472				
	5600 562				
	6800 682				
	8200 822				
Cap (µF)	0.010 103				
	0.012 123				
	0.015 153				
	0.018 183				
	0.022 223				
	0.027 273				
	0.033 333				
	0.039 393				
	0.047 473				
	0.056 563				
	0.068 683				
	0.082 823				
	0.100 104				
Voltage (V)	25	25	25	25	25
Rated Temp. (°C)	250	250	250	250	250
Case Size	AT05 = 0805	AT06 = 1206	AT10 = 1210	AT12 = 1812	AT14 = 2225

Voltage rating per table. Capacitance values specified at 25°C, derate capacitance value based on TCC and VCC Plots on page 2.

NOTE: Contact factory for non-specified capacitance values.

High Voltage MLC Chips

For 600V to 5000V Applications

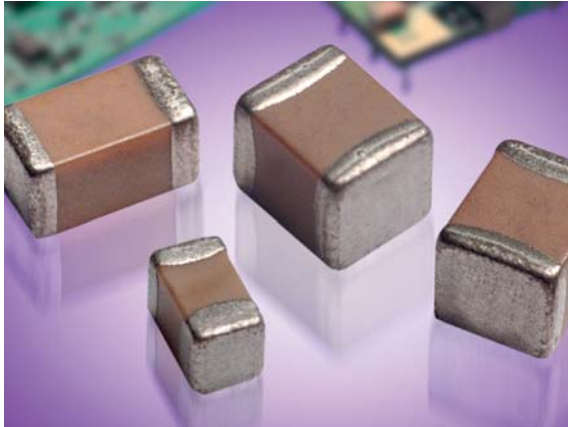

NEW 630V RANGE

High value, low leakage and small size are difficult parameters to obtain in capacitors for high voltage systems. AVX special high voltage MLC chip capacitors meet these performance characteristics and are designed for applications such as snubbers in high frequency power converters, resonators in SMPS, and high voltage coupling/dc blocking. These high voltage chip designs exhibit low ESRs at high frequencies.

Larger physical sizes than normally encountered chips are used to make high voltage MLC chip products. Special precautions must be taken in applying these chips in surface mount assemblies. The temperature gradient during heating or cooling cycles should not exceed 4°C per second. The preheat temperature must be within 50°C of the peak temperature reached by the ceramic bodies through the soldering process. Chip sizes 1210 and larger should be reflow soldered only. Capacitors may require protective surface coating to prevent external arcing.

For 1825, 2225 and 3640 sizes, AVX offers leaded version in either thru-hole or SMT configurations (for details see section on high voltage leaded MLC chips).

HOW TO ORDER

1808	A	A	271	K	A	1	2	A
AVX Style	Voltage	Temperature Coefficient	Capacitance Code	Capacitance Tolerance	Test Level	Termination*	Packaging	Special Code
0805	600V/630V = C	NPO (COG) = A	(2 significant digits + no. of zeros)	COG: J = ±5%	A = Standard	1 = Pd/Ag T = Plated Ni and Sn (RoHS Compliant)	1 or 2 = 7" Reel** 3 or 4 = 13" Reel	A = Standard
1206	1000V = A	X7R = C	Examples:	K = ±10%				
1210	1500V = S		10 pF = 100	M = ±20%				
1808	2000V = G		100 pF = 101	X7R: K = ±10%				
1812	2500V = W		1,000 pF = 102	M = ±20%				
1825	3000V = H		22,000 pF = 223	Z = +80%, -20%				
2220	4000V = J		220,000 pF = 224					
2225	5000V = K		1 μF = 105					
3640								

***Note:** Terminations with 5% minimum lead (Pb) is available, see pages 98 and 99 for LD style. Leaded terminations are available, see pages 100-104.

Notes: Capacitors with X7R dielectrics are not intended for applications across AC supply mains or AC line filtering with polarity reversal. Contact plant for recommendations. Contact factory for availability of Termination and Tolerance options for Specific Part Numbers.

** The 3640 Style is not available on 7" Reels.

*** AVX offers nonstandard chip sizes. Contact factory for details.

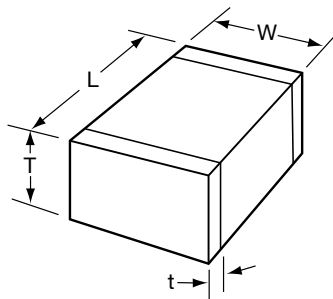

DIMENSIONS

millimeters (inches)

SIZE	0805	1206	1210*	1808*	1812*	1825*	2220*	2225*	3640*
(L) Length	2.10 ± 0.20 (0.083 ± 0.008)	3.30 ± 0.30 (0.130 ± 0.012)	3.30 ± 0.40 (0.130 ± 0.016)	4.60 ± 0.50 (0.181 ± 0.020)	4.60 ± 0.50 (0.181 ± 0.020)	4.60 ± 0.50 (0.181 ± 0.020)	5.70 ± 0.50 (0.224 ± 0.020)	5.70 ± 0.50 (0.224 ± 0.020)	9.14 ± 0.25 (0.360 ± 0.010)
(W) Width	1.25 ± 0.20 (0.049 ± 0.008)	1.60 ^{+0.30} _{-0.10} (0.063 ^{+0.012} _{-0.004})	2.50 ± 0.30 (0.098 ± 0.012)	2.00 ± 0.20 (0.079 ± 0.008)	3.20 ± 0.30 (0.126 ± 0.012)	6.30 ± 0.40 (0.248 ± 0.016)	5.00 ± 0.40 (0.197 ± 0.016)	6.30 ± 0.40 (0.248 ± 0.016)	10.2 ± 0.25 (0.400 ± 0.010)
(T) Thickness Max.	1.35 (0.053)	1.80 (0.071)	2.80 (0.110)	2.20 (0.087)	2.80 (0.110)	3.40 (0.134)	3.40 (0.134)	3.40 (0.134)	2.54 (0.100)
(t) terminal min. max.	0.50 ± 0.20 (0.020 ± 0.008)	0.60 ± 0.20 (0.024 ± 0.008)	0.75 ± 0.35 (0.030 ± 0.014)	0.75 ± 0.35 (0.030 ± 0.014)	0.75 ± 0.35 (0.030 ± 0.014)	0.75 ± 0.35 (0.030 ± 0.014)	0.85 ± 0.35 (0.033 ± 0.014)	0.85 ± 0.35 (0.033 ± 0.014)	0.76 (0.030) 1.52 (0.060)

*Reflow Soldering Only

High Voltage MLC Chips

For 600V to 5000V Applications

NP0 (C0G) Dielectric Performance Characteristics

Capacitance Range	10 pF to 0.100 μF (25°C, 1.0 ±0.2 Vrms at 1kHz, for ≤ 1000 pF use 1 MHz)
Capacitance Tolerances	±5%, ±10%, ±20%
Dissipation Factor	0.1% max. (+25°C, 1.0 ±0.2 Vrms, 1kHz, for ≤ 1000 pF use 1 MHz)
Operating Temperature Range	-55°C to +125°C
Temperature Characteristic	0 ±30 ppm/°C (0 VDC)
Voltage Ratings	600, 630, 1000, 1500, 2000, 2500, 3000, 4000 & 5000 VDC (+125°C)
Insulation Resistance (+25°C, at 500 VDC)	100K MΩ min. or 1000 MΩ - μF min., whichever is less
Insulation Resistance (+125°C, at 500 VDC)	10K MΩ min. or 100 MΩ - μF min., whichever is less
Dielectric Strength	Minimum 120% rated voltage for 5 seconds at 50 mA max. current

NP0 (C0G) CAPACITANCE RANGE – PREFERRED SIZES ARE SHADED

Case Size	0805					1206					1210					1808								1812							
	Reflow/Wave					Reflow/Wave					Reflow Only					Reflow Only								Reflow Only							
(L) Length mm (in.)	2.10 ± 0.20 (0.085 ± 0.008)					3.30 ± 0.30 (0.130 ± 0.012)					3.30 ± 0.40 (0.130 ± 0.016)					4.60 ± 0.50 (0.181 ± 0.020)								4.60 ± 0.50 (0.177 ± 0.012)							
(W) Width mm (in.)	1.25 ± 0.20 (0.049 ± 0.008)					1.60 ± 0.30/-0.10 (0.063 ± 0.012/-0.004)					2.50 ± 0.30 (0.098 ± 0.012)					2.00 ± 0.20 (0.079 ± 0.008)								3.20 ± 0.30 (0.126 ± 0.008)							
(T) Thickness mm (in.)	1.35 (0.053)					1.80 (0.071)					2.80 (0.110)					2.20 (0.087)								2.80 (0.100)							
(t) Terminal min max	0.50 ± 0.20 (0.020 ± 0.008)					0.60 ± 0.20 (0.024 ± 0.008)					0.75 ± 0.35 (0.030 ± 0.014)					0.75 ± 0.35 (0.030 ± 0.014)								0.75 ± 0.35 (0.030 ± 0.014)							
Voltage (V)	600	630	1000	600	630	1000	1500	2000	600	630	1000	1500	2000	600	630	1000	1500	2000	2500	3000	4000	600	630	1000	1500	2000	2500	3000	4000		
1.5 1R5	A	A		X	X	X	X	X																							
1.8 1R8	A	A		X	X	X	X	X																							
2.2 2R2	A	A		X	X	X	X	X																							
2.7 2R7	A	A		X	X	X	X	X																							
3.3 3R3	A	A		X	X	X	X	X																							
3.9 3R9	A	A		X	X	X	X	X																							
4.7 4R7	A	A		X	X	X	X	X																							
5.6 5R6	A	A		X	X	X	X	X																							
6.8 6R8	A	A		X	X	X	X	X																							
8.2 8R2	A	A		X	X	X	X	X																							
10 100	A	A	A	X	X	X	X	X	C	C	D	D	D	C	C	C	C	C	C	C	C	C	C	C	C	C	C	C	E		
12 120	A	A	A	X	X	X	X	X	C	C	D	D	D	C	C	C	C	C	C	C	C	C	C	C	C	C	C	C	E		
15 150	A	A	A	X	X	X	X	X	C	C	D	D	D	C	C	C	C	C	C	C	C	C	C	C	C	C	C	C	E		
18 180	A	A	A	X	X	X	X	X	C	C	D	D	D	C	C	C	C	C	C	C	C	C	C	C	C	C	C	C	E		
22 220	A	A	A	X	X	X	X	X	C	C	D	D	D	C	C	C	C	C	C	C	C	C	C	C	C	C	C	C	E		
27 270	A	A	A	X	X	X	X	X	C	C	D	D	D	C	C	C	C	C	C	C	C	C	C	C	C	C	C	C	E		
33 330	A	A	A	X	X	X	D	D	C	C	D	D	D	C	C	C	C	C	C	C	C	C	C	C	C	C	C	C	E		
39 390	A	A	A	X	X	X	D	D	C	C	D	D	D	C	C	C	C	C	C	C	C	C	C	C	C	C	C	C	E		
47 470	A	A	A	X	X	M	D	D	C	C	D	D	D	C	C	C	C	C	C	C	C	C	C	C	C	C	C	C	E		
56 560	A	A	A	X	X	M	C	C	C	C	D	C	C	C	C	C	C	C	C	C	C	C	C	C	C	C	C	C	F		
68 680	A	A	A	X	X	M	C	C	C	C	D	C	C	C	C	C	C	C	C	C	C	C	C	C	C	C	C	C	F		
82 820	X	X	X	X	X	C	C	C	C	C	D	C	C	C	C	C	C	C	C	C	C	C	C	C	C	C	C	C	F		
100 101	X	X	X	X	X	C	C	C	C	C	D	C	C	C	C	C	C	C	C	C	C	C	C	C	C	C	C	C	F		
120 121	C	C	C	X	X	C	E	E	C	C	C	C	C	C	C	C	C	C	C	C	C	F	F	F	F	F	F	F	F		
150 151	C	C	C	X	X	C	E	E	C	C	C	E	E	C	C	C	F	F	F	F	F	F	F	F	F	F	F	F	G		
180 181	C	C	C	X	X	E	E	E	C	C	E	E	E	C	C	C	F	F	F	F	F	F	F	F	F	F	F	F	F		
220 221	C	C	C	X	X	E	E	E	C	C	E	E	E	C	C	C	F	F	F	F	F	F	F	F	F	F	F	F	F		
270 271	C	C	C	C	C	E	E	E	C	C	E	E	E	C	C	C	F	F	F	F	F	F	F	F	F	F	F	F	F		
330 331	C	C	C	C	C	E	E	E	C	C	E	E	E	C	C	C	F	F	F	F	F	F	F	F	F	F	F	F	F		
390 391	C	C	C	C	C	E	E	E	C	C	E	E	E	C	C	C	F	F	F	F	F	F	F	F	F	F	F	F	F		
470 471	C	C	C	C	C	E	E	E	C	C	E	E	E	C	C	C	F	F	F	F	F	F	F	F	F	F	F	F	F		
560 561	C	C	C	C	C	E	E	E	C	C	E	E	E	C	C	C	F	F	F	F	F	F	F	F	F	F	F	F	F		
680 681	C	C	C	C	C	E	E	E	C	C	E	F	F	C	C	F	F	F	F	F	F	F	F	F	F	F	F	F	G		
750 751	C	C	C	E	E	E	E	E	C	C	E	G	G	C	C	F	F	F	F	F	F	F	F	F	F	F	F	F	G		
820 821	C	C		E	E	E	E	E	C	C	E	G	G	C	C	F	E	E	E	E	E	E	E	E	E	E	E	E	G		
1000 102				E	E	E	E	E	C	C	E	F	F	E	C	F	E	E	E	E	E	E	E	E	E	E	E	E	G		
1200 122				E	E	E	E	E	C	C	E	E	E	E	C	E	F	E	E	E	E	E	E	E	E	E	E	E	G		
1500 152				E	E	E	E	E	C	C	G			E	E	F													G		
1800 182				E	E	E	E	E	C	C	G			E	E	F													G		
2200 222				E	E	E	E	E	E	E				E	E	F													G		
2700 272				E	E	E	E	E	E	E				E	E														G		
3300 332				E	E	E	E	E	E	E				E	E														G		
3900 392				E	E	E	E	E	E	E				E	E														G		
4700 472				E	E	E	E	E	E	E				E	E														G		
5600 562				E	E	E	E	E	E	E				E	E														G		
6800 682														E	E														G		
8200 822																													G		
0.010 103																													G		
0.012 123																													G		
0.015 153																													G		
0.018 183																													G		
0.022 223																													G		
0.033 333																													G		
0.047 473																													G		
0.056 563																													G		
0.068 683																													G		
0.100 104																													G		
Voltage (V)	600	630	1000	600	630	1000	1500	2000	600	630	1000	1500	2000	600	630	1000	1500	2000	2500	3000	4000	600	630	1000	1500	2000	2500	3000	4000		
Case Size	0805					1206					1210					1808								1812							

Letter	A	C	E	F	G	X	7
Max. Thickness	0.813 (0.032)	1.448 (0.057)	1.8034 (0.071)	2.2098 (0.087)	2.794 (0.110)	0.940 (0.037)	3.30 (0.130)

NOTE: Contact factory for non-specified capacitance values



High Voltage MLC Chips

For 600V to 5000V Applications

X7R Dielectric Performance Characteristics

Capacitance Range	10 pF to 0.82 μF (25°C, 1.0 ±0.2 Vrms at 1kHz)
Capacitance Tolerances	±10%; ±20%; +80%, -20%
Dissipation Factor	2.5% max. (+25°C, 1.0 ±0.2 Vrms, 1kHz)
Operating Temperature Range	-55°C to +125°C
Temperature Characteristic	±15% (0 VDC)
Voltage Ratings	600, 630, 1000, 1500, 2000, 2500, 3000, 4000 & 5000 VDC (+125°C)
Insulation Resistance (+25°C, at 500 VDC)	100K MΩ min. or 1000 MΩ - μF min., whichever is less
Insulation Resistance (+125°C, at 500 VDC)	10K MΩ min. or 100 MΩ - μF min., whichever is less
Dielectric Strength	Minimum 120% rated voltage for 5 seconds at 50 mA max. current

X7R CAPACITANCE RANGE – PREFERRED SIZES ARE SHADED

Case Size	0805			1206				1210				1808						1812											
	Reflow/Wave			Reflow/Wave				Reflow Only				Reflow Only						Reflow Only											
(L) Length mm (in.)	2.10 ± 0.20 (0.085 ± 0.008)			3.30 ± 0.30 (0.130 ± 0.012)				3.30 ± 0.40 (0.130 ± 0.016)				4.60 ± 0.50 (0.181 ± 0.020)						4.60 ± 0.50 (0.177 ± 0.012)											
(W) Width mm (in.)	1.25 ± 0.20 (0.049 ± 0.008)			1.60 +0.30/-0.10 (0.063 +0.012/-0.004)				2.50 ± 0.30 (0.098 ± 0.012)				2.00 ± 0.20 (0.079 ± 0.008)						3.20 ± 0.30 (0.126 ± 0.008)											
(T) Thickness mm (in.)	1.35 (0.053)			1.80 (0.071)				2.80 (0.110)				2.20 (0.087)						2.80 (0.100)											
(t) Terminal min max	0.50 ± 0.20 (0.020 ± 0.008)			0.60 ± 0.20 (0.024 ± 0.008)				0.75 ± 0.35 (0.030 ± 0.014)				0.75 ± 0.35 (0.030 ± 0.014)						0.75 ± 0.35 (0.030 ± 0.014)											
Voltage (V)	600	630	1000	600	630	1000	1500	2000	600	630	1000	1500	2000	600	630	1000	1500	2000	2500	3000	4000	600	630	1000	1500	2000	2500	3000	4000
Cap (pF) 100 101	X	X	C	C	C	E	E	E	E	E	E	E	E																
120 121	X	X	C	C	C	E	E	E	E	E	E	E	E																
150 151	X	X	C	C	C	E	E	E	E	E	E	E	E																
180 181	X	X	C	C	C	E	E	E	E	E	E	E	E																
220 221	X	X	C	C	C	E	E	E	E	E	E	E	E																
270 271	X	X	C	C	C	E	E	E	E	E	E	E	E										E	E	E	E	E		
330 331	X	X	C	C	C	E	E	E	E	E	E	E	E	E	E	E	E	E	E	F			E	E	E	E	E		
390 391	X	X	C	C	C	E	E	E	E	E	E	E	E	E	E	E	E	E	E	F			E	E	E	E	E		
470 471	X	X	C	C	C	E	E	E	E	E	E	E	E	E	E	E	E	E	E	F			E	E	E	E	E	E	
560 561	X	X	C	C	C	E	E	E	E	E	E	E	E	E	E	E	E	E	F	F			E	E	E	E	E	E	
680 681	X	X	C	C	C	E	E	E	E	E	E	E	E	E	E	E	E	E	F	F			E	E	E	E	E	F	F
750 751	X	X	C	C	C	E	E	E	E	E	E	E	E	E	E	E	E	E	F	F			E	E	E	E	E	F	F
820 821	X	X	C	C	C	E	E	E	E	E	E	E	E	E	E	E	E	E	F	F			E	E	E	E	E	F	F
1000 102	X	X	X	C	C	E	E	E	E	E	E	E	E	E	E	E	E	E	F	F			E	E	E	E	E	F	F
1200 122	X	X	X	C	C	E	E	E	E	E	E	E	E	E	E	E	E	E	F	F			E	E	E	E	E	F	F
1500 152	X	X	X	C	C	E	E	E	E	E	E	E	E	E	E	E	E	E	F	F			E	E	E	E	E	G	G
1800 182	X	X	X	C	C	E	E	E	E	E	E	E	E	E	E	E	E	E	F	F			E	E	E	E	E	G	G
2200 222	X	X	X	C	C	E	E	E	E	E	E	E	E	E	E	E	E	E	F	F			E	E	E	E	E	G	G
2700 272	C	C		C	C	E	E			E	E	E	F	E	E	E	E	F	F			E	E	E	E	E	G	G	
3300 332	C	C		C	C	E				E	E	E	F	E	E	E	E	F	F			E	E	E	F	F	G	G	
3900 392	C	C		C	C	E				E	E	E	F		E	E	E	F				E	E	E	F	F	G	G	
4700 472	C	C		C	C	E				E	E	E	F		E	E	E	F				E	E	E	F	F	G	G	
5600 562	C	C		C	C	E				E	E	E	F		E	E	E	F				E	E	E	G	G	G		
6800 682	C	C		C	C	E				E	E	E	F		E	E	E	F				E	E	E	G	G			
8200 822	C	C		C	C	E				E	E	E			E	E	E					E	E	E	G	G			
Cap (μF) 0.010 103	C	C		C	C	E				E	E	E			E	E	E					E	E	F	G	G			
0.015 153	C	C		E	E	E				E	E	E			F	F	F					E	E	F	G				
0.018 183	C	C		E	E					E	E	E			F	F	F					E	E	G					
0.022 223	C	C		E	E					E	E	E	F		F	F						E	E	G					
0.027 273				E	E					E	E	E			F	F						E	E	G					
0.033 333				E	E					E	E				F	F						E	E	G					
0.039 393										E	E				F	F						E	E	G					
0.047 473										E	E				F	F						E	E	G					
0.056 563										F	F				F	F						F	F						
0.068 683										F	F				F	F						F	F						
0.082 823										F	F											F	F						
0.100 104										F	F											F	F						
0.150 154																						G	G						
0.220 224																						G	G						
0.270 274																													
0.330 334																													
0.390 394																													
0.470 474																													
0.560 564																													
0.680 684																													
0.820 824																													
1.000 105																													
Voltage (V)	600	630	1000	600	630	1000	1500	2000	600	630	1000	1500	2000	600	630	1000	1500	2000	2500	3000	4000	600	630	1000	1500	2000	2500	3000	4000
Case Size	0805			1206				1210				1808						1812											

Letter	A	C	E	F	G	X	7
Max. Thickness	0.813 (0.032)	1.448 (0.057)	1.8034 (0.071)	2.2098 (0.087)	2.794 (0.110)	0.940 (0.037)	3.30 (0.130)

NOTE: Contact factory for non-specified capacitance values

High Voltage MLC Chips

For 600V to 5000V Applications

X7R CAPACITANCE RANGE
PREFERRED SIZES ARE SHADED

Case Size	1825								2220								2225								3640										
Soldering	Reflow Only								Reflow Only								Reflow Only								Reflow Only										
(L) Length mm (in.)	4.60 ± 0.50 (0.181 ± 0.020)								5.70 ± 0.50 (0.224 ± 0.020)								5.70 ± 0.50 (0.225 ± 0.010)								9.14 ± 0.25 (0.360 ± 0.010)										
(W) Width mm (in.)	6.30 ± 0.40 (0.248 ± 0.016)								5.00 ± 0.40 (0.197 ± 0.016)								6.30 ± 0.40 (0.250 ± 0.010)								10.2 ± 0.25 (0.400 ± 0.010)										
(T) Thickness mm (in.)	3.40 (0.134)								3.40 (0.134)								3.40 (0.100)								2.54 (0.100)										
(t) Terminal min max	0.75 ± 0.35 (0.030 ± 0.014)								0.85 ± 0.35 (0.033 ± 0.014)								0.85 ± 0.35 (0.033 ± 0.014)								0.76 (0.030) 1.52 (0.060)										
Voltage (V)	600	630	1000	1500	2000	2500	3000	4000	600	630	1000	1500	2000	2500	3000	4000	5000	600	630	1000	1500	2000	2500	3000	4000	5000	600	630	1000	1500	2000	2500	3000	4000	5000
Cap (pF) 100 101																																			
120 121																																			
150 151																																			
180 181																																			
220 221																																			
270 271																																			
330 331																																			
390 391																																			
470 471																																			
560 561																																			
680 681																																			
750 751																																			
820 821																																			
1000 102	F	F	F	F	F	F	F	F	F	F	F	F	F	F	F	G										G	G	G	G	G	G	G	G	G	
1200 122	F	F	F	F	F	F	F	F	F	F	F	F	F	F	F	G										F	F	F	F	F	F	F	F	F	
1500 152	F	F	F	F	F	F	F	F	F	F	F	F	F	F	F	G										F	F	F	F	F	F	F	F	F	
1800 182	F	F	F	F	F	F	F	F	F	F	F	F	F	F	F	G										F	F	F	F	F	F	F	F	F	
2200 222	F	F	F	F	F	F	F	F	F	F	F	F	F	F	F	G										F	F	F	F	F	F	F	F	F	
2700 272	F	F	F	F	F	F	F	F	F	F	F	F	F	F	F	G										F	F	F	F	F	F	F	F	F	
3300 332	F	F	F	F	F	F	F	F	F	F	F	F	F	F	F	G										F	F	F	F	F	F	F	F	F	
3900 392	F	F	F	F	F	F	F	F	F	F	F	F	F	F	F	G										F	F	F	F	F	F	F	F	F	
4700 472	F	F	F	F	F	F	F	F	F	F	F	F	F	F	F	G										F	F	F	F	F	F	F	F	F	
5600 562	F	F	F	F	F	F	F	F	F	F	F	F	F	F	F	G										F	F	F	F	F	F	F	F	F	
6800 682	F	F	F	G	G	G	G	G	F	F	F	F	F	F	G	G										F	F	F	F	F	F	G	G	G	
8200 822	F	F	F	G	G	G	G	G	F	F	F	G	G	G	G	G										F	F	F	G	G	G	G	G	G	
Cap (µF) 0.010 103	F	F	F	G	G	G	G	G	F	F	F	G	G	G	G	G										F	F	F	F	F	F	G	G	G	
0.015 153	F	F	F	G	G	G	G	G	F	F	F	G	G	G	G										F	F	F	G	G	G	G	G	G		
0.018 183	F	F	F	G	G	G	G	G	F	F	F	G	G	G	G										F	F	F	G	G	G	G	G	G		
0.022 223	F	F	F	G	G	G	G	G	F	F	F	G	G	G	G										F	F	F	G	G	G	G	G	G		
0.027 273	F	F	F	G	G	G	G	G	F	F	F	G	G	G	G										F	F	F	G	G	G	G	G	G		
0.033 333	F	F	F	G	G	G	G	G	F	F	F	G	G	G	G										F	F	F	G	G	G	G	G	G		
0.039 393	F	F	F	G	G	G	G	G	F	F	F	G	G	G	G										F	F	F	G	G	G	G	G	G		
0.047 473	F	F	F	P	P	P	P	P	F	F	F	G	G	G	G										F	F	F	G	G	G	G	G	G		
0.056 563	F	F	F	G	G	G	G	G	F	F	F	G	G	G	G										F	F	F	G	G	G	G	G	G		
0.068 683	F	F	G	G	G	G	G	G	F	F	G	G	G	G	G										F	F	F	G	G	G	G	G	G		
0.082 823	F	F	G	G	G	G	G	G	F	F	G	G	G	G	G										F	F	G	G	G	G	G	G	G		
0.100 104	F	F	G	G	G	G	G	G	F	F	G	G	G	G	G										F	F	G	G	G	G	G	G	G		
0.150 154	F	F	G	G	G	G	G	G	F	F	G	G	G	G	G										F	F	G	G	G	G	G	G	G		
0.220 224	F	F	G	G	G	G	G	G	F	F	G	G	G	G	G										F	F	G	G	G	G	G	G	G		
0.270 274	F	F	G	G	G	G	G	G	F	F	G	G	G	G	G										F	F	G	G	G	G	G	G	G		
0.330 334	F	F	G	G	G	G	G	G	F	F	G	G	G	G	G										F	F	G	G	G	G	G	G	G		
0.390 394	F	F	G	G	G	G	G	G	F	F	G	G	G	G	G										F	F	G	G	G	G	G	G	G		
0.470 474	F	F	G	G	G	G	G	G	F	F	G	G	G	G	G										F	F	G	G	G	G	G	G	G		
0.560 564	G	G	G	G	G	G	G	G	G	G	G	G	G	G	G										G	G	G	G	G	G	G	G	G		
0.680 684	G	G	G	G	G	G	G	G	G	G	G	G	G	G	G										G	G	G	G	G	G	G	G	G		
0.820 824	G	G	G	G	G	G	G	G	G	G	G	G	G	G	G										G	G	G	G	G	G	G	G	G		
1.000 105																																			
Voltage (V)	600	630	1000	1500	2000	2500	3000	4000	600	630	1000	1500	2000	2500	3000	4000	5000	600	630	1000	1500	2000	2500	3000	4000	5000	600	630	1000	1500	2000	2500	3000	4000	5000

Letter	A	C	E	F	G	X	7
Max. Thickness	0.813 (0.032)	1.448 (0.057)	1.8034 (0.071)	2.2098 (0.087)	2.794 (0.110)	0.940 (0.037)	3.30 (0.130)

NOTE: Contact factory for non-specified capacitance values



High Voltage MLC Chips Tin/Lead Termination "B"

For 600V to 5000V Applications

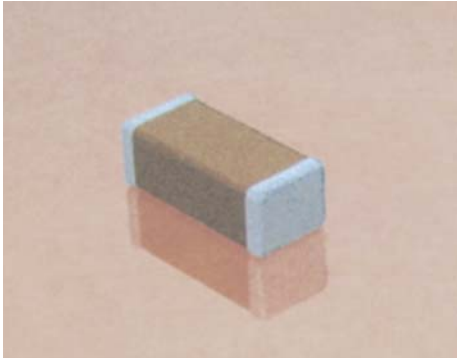

NEW 630V RANGE

AVX Corporation will support those customers for commercial and military Multi-layer Ceramic Capacitors with a termination consisting of 5% minimum lead. This termination is indicated by the use of a "B" in the 12th position of the AVX Catalog Part Number. This fulfills AVX's commitment to providing a full range of products to our customers. AVX has provided in the following pages, a full range of values that we are offering in this "B" termination.

Larger physical sizes than normally encountered chips are used to make high voltage MLC chip product. Special precautions must be taken in applying these chips in surface mount assemblies. The temperature gradient during heating or cooling cycles should not exceed 4°C per second. The preheat temperature must be within 50°C of the peak temperature reached by the ceramic bodies through the soldering process. Chip sizes 1210 and larger should be reflow soldered only. Capacitors may require protective surface coating to prevent external arcing.

For 1825, 2225 and 3640 sizes, AVX offers leaded version in either thru-hole or SMT configurations (for details see section on high voltage leaded MLC chips).

HOW TO ORDER

LD08	A	A	271	K	A	B	1	A
AVX Style	Voltage	Temperature Coefficient	Capacitance Code (2 significant digits + no. of zeros) Examples:	Capacitance Tolerance COG: J = ±5% K = ±10% X7R: K = ±10% M = ±20% Z = +80%, -20%	Test Level A = Standard	Termination B = 5% Min Pb X = FLEXITERM® with 5% min. Pb*	Packaging 2 = 7" Reel** 4 = 13" Reel	Special Code A = Standard
LD05 - 0805	600V/630V = C	C0G = A	10 pF = 100					
LD06 - 1206	1000V = A	X7R = C	100 pF = 101					
LD10 - 1210	1500V = S		1,000 pF = 102					
LD08 - 1808	2000V = G		22,000 pF = 223					
LD12 - 1812	2500V = W		220,000 pF = 224					
LD13 - 1825	3000V = H		1 μF = 105					
LD20 - 2220	4000V = J							
LD14 - 2225	5000V = K							
LD40 - 3640								

Notes: Capacitors with X7R dielectrics are not intended for applications across AC supply mains or AC line filtering with polarity reversal. Contact plant for recommendations. Contact factory for availability of Termination and Tolerance options for Specific Part Numbers.

* FLEXITERM is not available in the LD40 Style

** The LD40 Style is not available on 7" Reels.

*** AVX offers nonstandard chip sizes. Contact factory for details.

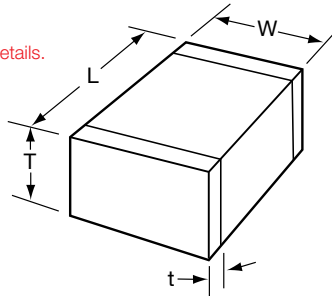

Not RoHS Compliant

DIMENSIONS

	millimeters (inches)								
SIZE	LD05 (0805)	LD06 (1206)	LD10* (1210)	LD08* (1808)	LD12* (1812)	LD13* (1825)	LD20* (2220)	LD14* (2225)	LD40* (3640)
(L) Length	2.10 ± 0.20 (0.083 ± 0.008)	3.30 ± 0.30 (0.130 ± 0.012)	3.30 ± 0.40 (0.130 ± 0.016)	4.60 ± 0.50 (0.181 ± 0.020)	4.60 ± 0.50 (0.181 ± 0.020)	4.60 ± 0.50 (0.181 ± 0.020)	5.70 ± 0.50 (0.224 ± 0.020)	5.70 ± 0.50 (0.224 ± 0.020)	9.14 ± 0.25 (0.360 ± 0.010)
(W) Width	1.25 ± 0.20 (0.049 ± 0.008)	1.60 ^{+0.30} _{-0.10} (0.063 ^{+0.012} _{-0.004})	2.50 ± 0.30 (0.098 ± 0.012)	2.00 ± 0.20 (0.079 ± 0.008)	3.20 ± 0.30 (0.126 ± 0.012)	6.30 ± 0.40 (0.248 ± 0.016)	5.00 ± 0.40 (0.197 ± 0.016)	6.30 ± 0.40 (0.248 ± 0.016)	10.2 ± 0.25 (0.400 ± 0.010)
(T) Thickness Max.	1.35 (0.053)	1.80 (0.071)	2.80 (0.110)	2.20 (0.087)	2.80 (0.110)	3.40 (0.134)	3.40 (0.134)	3.40 (0.134)	2.54 (0.100)
(t) terminal min. max.	0.50 ± 0.20 (0.020 ± 0.008)	0.60 ± 0.20 (0.024 ± 0.008)	0.75 ± 0.35 (0.030 ± 0.014)	0.75 ± 0.35 (0.030 ± 0.014)	0.75 ± 0.35 (0.030 ± 0.014)	0.75 ± 0.35 (0.030 ± 0.014)	0.85 ± 0.35 (0.033 ± 0.014)	0.85 ± 0.35 (0.033 ± 0.014)	0.76 (0.030) 1.52 (0.060)

* Reflow soldering only.



Performance of SMPS capacitors can be simulated by downloading SpiCalci software program - <http://www.avx.com/SpiApps/default.asp#spicalci>
Custom values, ratings and configurations are also available.



High Voltage MLC Chips Tin/Lead Termination “B”

For 600V to 5000V Applications

C0G Dielectric

Performance Characteristics

Capacitance Range	10 pF to 0.047 μ F (25°C, 1.0 \pm 0.2 Vrms at 1kHz, for \leq 1000 pF use 1 MHz)
Capacitance Tolerances	\pm 5%, \pm 10%, \pm 20%
Dissipation Factor	0.1% max. (+25°C, 1.0 \pm 0.2 Vrms, 1kHz, for \leq 1000 pF use 1 MHz)
Operating Temperature Range	-55°C to +125°C
Temperature Characteristic	0 \pm 30 ppm/°C (0 VDC)
Voltage Ratings	600, 630, 1000, 1500, 2000, 2500, 3000, 4000 & 5000 VDC (+125°C)
Insulation Resistance (+25°C, at 500 VDC)	100K M Ω min. or 1000 M Ω - μ F min., whichever is less
Insulation Resistance (+125°C, at 500 VDC)	10K M Ω min. or 100 M Ω - μ F min., whichever is less
Dielectric Strength	Minimum 120% rated voltage for 5 seconds at 50 mA max. current

HIGH VOLTAGE C0G CAPACITANCE VALUES

VOLTAGE	LD05 (0805)	LD06 (1206)	LD10 (1210)	LD08 (1808)	LD12 (1812)	LD13 (1825)	LD20 (2220)	LD14 (2225)	LD40 (3640)	
600/630	min.	10pF	10 pF	100 pF	100 pF	100 pF	1000 pF	1000 pF	1000 pF	1000 pF
	max.	330pF	1200 pF	2700 pF	3300 pF	5600 pF	0.012 μ F	0.012 μ F	0.018 μ F	0.047 μ F
1000	min.	10pF	10 pF	10 pF	100 pF	100 pF	100 pF	1000 pF	1000 pF	1000 pF
	max.	180pF	560 pF	1500 pF	2200 pF	3300 pF	8200 pF	0.010 μ F	0.010 μ F	0.022 μ F
1500	min.	—	10 pF	10 pF	10 pF	10 pF	100 pF	100 pF	100 pF	100 pF
	max.	—	270 pF	680 pF	820 pF	1800 pF	4700 pF	4700 pF	5600 pF	0.010 μ F
2000	min.	—	10 pF	10 pF	10 pF	10 pF	100 pF	100 pF	100 pF	100 pF
	max.	—	120 pF	270 pF	330 pF	1000 pF	1800 pF	2200 pF	2700 pF	6800 pF
2500	min.	—	—	—	10 pF	10 pF	10 pF	100 pF	100 pF	100 pF
	max.	—	—	—	180 pF	470 pF	1200 pF	1500 pF	1800 pF	3900 pF
3000	min.	—	—	—	10 pF	10 pF	10 pF	10 pF	10 pF	100 pF
	max.	—	—	—	120 pF	330 pF	820 pF	1000 pF	1200 pF	2700 pF
4000	min.	—	—	—	10 pF	10 pF	10 pF	10 pF	10 pF	100 pF
	max.	—	—	—	47 pF	150 pF	330 pF	470 pF	560 pF	1200 pF
5000	min.	—	—	—	—	—	—	10 pF	10 pF	10 pF
	max.	—	—	—	—	—	—	220 pF	270 pF	820 pF

X7R Dielectric

Performance Characteristics

Capacitance Range	10 pF to 0.56 μ F (25°C, 1.0 \pm 0.2 Vrms at 1kHz)
Capacitance Tolerances	\pm 10%; \pm 20%; +80%, -20%
Dissipation Factor	2.5% max. (+25°C, 1.0 \pm 0.2 Vrms, 1kHz)
Operating Temperature Range	-55°C to +125°C
Temperature Characteristic	\pm 15% (0 VDC)
Voltage Ratings	600, 630, 1000, 1500, 2000, 2500, 3000, 4000 & 5000 VDC (+125°C)
Insulation Resistance (+25°C, at 500 VDC)	100K M Ω min. or 1000 M Ω - μ F min., whichever is less
Insulation Resistance (+125°C, at 500 VDC)	10K M Ω min. or 100 M Ω - μ F min., whichever is less
Dielectric Strength	Minimum 120% rated voltage for 5 seconds at 50 mA max. current

HIGH VOLTAGE X7R MAXIMUM CAPACITANCE VALUES

VOLTAGE	0805	1206	1210	1808	1812	1825	2220	2225	3640	
600/630	min.	100pF	1000 pF	1000 pF	1000 pF	1000 pF	0.010 μ F	0.010 μ F	0.010 μ F	0.010 μ F
	max.	6800pF	0.022 μ F	0.056 μ F	0.068 μ F	0.120 μ F	0.270 μ F	0.270 μ F	0.330 μ F	0.560 μ F
1000	min.	100pF	100 pF	1000 pF	1000 pF	1000 pF	1000 pF	1000 pF	1000 pF	0.010 μ F
	max.	1500pF	6800 pF	0.015 μ F	0.018 μ F	0.039 μ F	0.100 μ F	0.120 μ F	0.150 μ F	0.220 μ F
1500	min.	—	100 pF	100 pF	100 pF	100 pF	1000 pF	1000 pF	1000 pF	1000 pF
	max.	—	2700 pF	5600 pF	6800 pF	0.015 μ F	0.056 μ F	0.056 μ F	0.068 μ F	0.100 μ F
2000	min.	—	10 pF	100 pF	100 pF	100 pF	1000 pF	1000 pF	1000 pF	1000 pF
	max.	—	1500 pF	3300 pF	3300 pF	8200 pF	0.022 μ F	0.027 μ F	0.033 μ F	0.027 μ F
2500	min.	—	—	—	10 pF	10 pF	100 pF	100 pF	100 pF	1000 pF
	max.	—	—	—	2200 pF	5600 pF	0.015 μ F	0.018 μ F	0.022 μ F	0.022 μ F
3000	min.	—	—	—	10 pF	10 pF	100 pF	100 pF	100 pF	1000 pF
	max.	—	—	—	1800 pF	3900 pF	0.010 μ F	0.012 μ F	0.015 μ F	0.018 μ F
4000	min.	—	—	—	—	—	—	—	—	100 pF
	max.	—	—	—	—	—	—	—	—	6800 pF
5000	min.	—	—	—	—	—	—	—	—	100 pF
	max.	—	—	—	—	—	—	—	—	3300 pF

High Voltage MLC Chips FLEXITERM®

For 600V to 5000V Applications

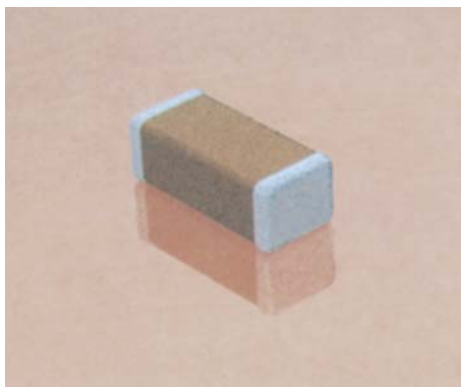

High value, low leakage and small size are difficult parameters to obtain in capacitors for high voltage systems. AVX special high voltage MLC chips capacitors meet these performance characteristics and are designed for applications such as snubbers in high frequency power converters, resonators in SMPS, and high voltage coupling/DC blocking. These high voltage chip designs exhibit low ESRs at high frequencies.

To make high voltage chips, larger physical sizes than are normally encountered are necessary. These larger sizes require that special precautions be taken in applying these chips in surface mount assemblies. In response to this, and to follow from the success of the FLEXITERM® range of low voltage parts, AVX is delighted to offer a FLEXITERM® high voltage range of capacitors, FLEXITERM®.

The FLEXITERM® layer is designed to enhance the mechanical flexure and temperature cycling performance of a standard ceramic capacitor, giving customers a solution where board flexure or temperature cycle damage are concerns.

HOW TO ORDER

1808	A	C	272	K	A	Z	1	A
AVX Style	Voltage	Temperature Coefficient	Capacitance Code (2 significant digits + no. of zeros) Examples:	Capacitance Tolerance COG: J = ±5% K = ±10% M = ±20% X7R: K = ±10% M = ±20% Z = +80%, -20%	Test Level	Termination* Z = FLEXITERM® 100% Tin (RoHS Compliant)	Packaging 2 = 7" Reel 4 = 13" Reel	Special Code A = Standard
0805	600V/630V = C	COG = A	10 pF = 100					
1206	1000V = A	X7R = C	100 pF = 101					
1210	1500V = S		1,000 pF = 102					
1808	2000V = G		22,000 pF = 223					
1812	2500V = W		220,000 pF = 224					
1825	3000V = H		1 μF = 105					
1825	4000V = J							
2220	5000V = K							
2225								

Notes: Capacitors with X7R dielectrics are not intended for applications across AC supply mains or AC line filtering with polarity reversal. Contact plant for recommendations. Contact factory for availability of Termination and Tolerance options for Specific Part Numbers.

*** AVX offers nonstandard chip sizes. Contact factory for details.

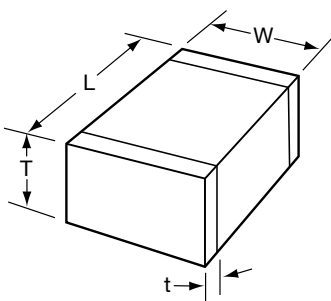

DIMENSIONS

millimeters (inches)

SIZE	0805	1206	1210*	1808*	1812*	1825*	2220*	2225*
(L) Length	2.10 ± 0.20 (0.083 ± 0.008)	3.30 ± 0.30 (0.130 ± 0.012)	3.30 ± 0.40 (0.130 ± 0.016)	4.60 ± 0.50 (0.181 ± 0.020)	4.60 ± 0.50 (0.181 ± 0.020)	4.60 ± 0.50 (0.181 ± 0.020)	5.70 ± 0.50 (0.224 ± 0.020)	5.70 ± 0.50 (0.224 ± 0.020)
(W) Width	1.25 ± 0.20 (0.049 ± 0.008)	1.60 ^{+0.30} _{-0.10} (0.063 ^{+0.012} _{-0.004})	2.50 ± 0.30 (0.098 ± 0.012)	2.00 ± 0.20 (0.079 ± 0.008)	3.20 ± 0.30 (0.126 ± 0.012)	6.30 ± 0.40 (0.248 ± 0.016)	5.00 ± 0.40 (0.197 ± 0.016)	6.30 ± 0.40 (0.248 ± 0.016)
(T) Thickness Max.	1.35 (0.053)	1.80 (0.071)	2.80 (0.110)	2.20 (0.087)	2.80 (0.110)	3.40 (0.134)	3.40 (0.134)	3.40 (0.134)
(t) terminal min. max.	0.50 ± 0.20 (0.020 ± 0.008)	0.60 ± 0.20 (0.024 ± 0.008)	0.75 ± 0.35 (0.030 ± 0.014)	0.75 ± 0.35 (0.030 ± 0.014)	0.75 ± 0.35 (0.030 ± 0.014)	0.75 ± 0.35 (0.030 ± 0.014)	0.85 ± 0.35 (0.033 ± 0.014)	0.85 ± 0.35 (0.033 ± 0.014)

*Reflow Soldering Only



Performance of SMPS capacitors can be simulated by downloading SpiCalci software program - <http://www.avx.com/SpiApps/default.asp#spicalci>
Custom values, ratings and configurations are also available.



High Voltage MLC Chips FLEXITERM®

For 600V to 5000V Applications

NP0 (C0G) Dielectric Performance Characteristics

Capacitance Range	10 pF to 0.100 µF (+25°C, 1.0 ±0.2 Vrms, 1kHz)
Capacitance Tolerances	±5%, ±10%, ±20%
Dissipation Factor	0.1% max. (+25°C, 1.0 ±0.2 Vrms, 1kHz)
Operating Temperature Range	-55°C to +125°C
Temperature Characteristic	0 ±30 ppm/°C (0 VDC)
Voltage Ratings	600, 630, 1000, 1500, 2000, 2500, 3000, 4000 & 5000 VDC (+125°C)
Insulation Resistance (+25°C, at 500 VDC)	100K MΩ min. or 1000 MΩ - µF min., whichever is less
Insulation Resistance (+125°C, at 500 VDC)	10K MΩ min. or 100 MΩ - µF min., whichever is less
Dielectric Strength	Minimum 120% rated voltage for 5 seconds at 50 mA max. current

NP0 (C0G) CAPACITANCE RANGE PREFERRED SIZES ARE SHADED

Case Size	0805			1206				1210					1808							1812									
	Reflow/Wave			Reflow/Wave				Reflow Only					Reflow Only							Reflow Only									
(L) Length mm (in.)	2.10 ± 0.20 (0.083 ± 0.008)			3.30 ± 0.30 (0.130 ± 0.012)				3.30 ± 0.40 (0.130 ± 0.016)					4.60 ± 0.50 (0.181 ± 0.020)							4.60 ± 0.50 (0.181 ± 0.020)									
(W) Width mm (in.)	1.25 ± 0.20 (0.049 ± 0.008)			1.60 +0.30/-0.10 (0.063 +0.012/-0.004)				2.50 ± 0.30 (0.098 ± 0.012)					2.00 ± 0.20 (0.079 ± 0.008)							3.20 ± 0.30 (0.126 ± 0.012)									
(T) Thickness mm (in.)	1.35 (0.053)			1.80 (0.071)				2.80 (0.110)					2.20 (0.087)							2.80 (0.110)									
(t) Terminal min max	0.50 ± 0.20 (0.020 ± 0.008)			0.60 ± 0.20 (0.024 ± 0.008)				0.75 ± 0.35 (0.030 ± 0.014)					0.75 ± 0.35 (0.030 ± 0.014)							0.75 ± 0.35 (0.030 ± 0.014)									
Voltage (V)	600	630	1000	600	630	1000	1500	2000	600	630	1000	1500	2000	600	630	1000	1500	2000	2500	3000	4000	600	630	1000	1500	2000	2500	3000	4000
Cap (pF) 1.5 1R5	A	A		X	X	X	X	X																					
1.8 1R8	A	A		X	X	X	X	X																					
2.2 2R2	A	A		X	X	X	X	X																					
2.7 2R7	A	A		X	X	X	X	X																					
3.3 3R3	A	A		X	X	X	X	X																					
3.9 3R9	A	A		X	X	X	X	X																					
4.7 4R7	A	A		X	X	X	X	X																					
5.6 5R6	A	A		X	X	X	X	X																					
6.8 6R8	A	A		X	X	X	X	X																					
8.2 8R2	A	A		X	X	X	X	X																					
10 100	A	A	A	X	X	X	X	X	C	C	D	D	D	C	C	C	C	C	C	C	C	C	C	C	C	C	C	C	E
12 120	A	A	A	X	X	X	X	X	C	C	D	D	D	C	C	C	C	C	C	C	C	C	C	C	C	C	C	C	E
15 150	A	A	A	X	X	X	X	X	C	C	D	D	D	C	C	C	C	C	C	C	C	C	C	C	C	C	C	C	E
18 180	A	A	A	X	X	X	X	X	C	C	D	D	D	C	C	C	C	C	C	C	C	C	C	C	C	C	C	C	E
22 220	A	A	A	X	X	X	X	X	C	C	D	D	D	C	C	C	C	C	C	C	C	C	C	C	C	C	C	C	E
27 270	A	A	A	X	X	X	X	X	C	C	D	D	D	C	C	C	C	C	C	C	C	C	C	C	C	C	C	C	E
33 330	A	A	A	X	X	X	X	D	D	C	D	D	D	C	C	C	C	C	C	C	C	C	C	C	C	C	C	C	E
39 390	A	A	A	X	X	X	X	D	D	C	D	D	D	C	C	C	C	C	C	C	C	C	C	C	C	C	C	C	E
47 470	A	A	A	X	X	M	D	D	C	C	D	D	D	C	C	C	C	C	C	C	C	C	C	C	C	C	C	C	E
56 560	A	A	A	X	X	M	C	C	C	C	D	C	C	C	C	C	C	C	C	C	C	C	C	C	C	C	C	C	F
68 680	A	A	A	X	X	M	C	C	C	C	D	C	C	C	C	C	C	C	C	C	C	C	C	C	C	C	C	C	F
82 820	X	X	X	X	X	C	C	C	C	C	D	C	C	C	C	C	C	C	C	C	C	C	C	C	C	C	C	C	F
100 101	X	X	X	X	X	C	C	C	C	C	C	C	C	C	C	C	C	C	C	C	C	C	C	C	C	C	C	C	F
120 121	C	C	C	X	X	C	E	E	C	C	C	C	C	C	C	C	C	C	C	C	C	C	C	C	C	C	C	C	G
150 151	C	C	C	X	X	C	E	E	C	C	C	C	E	E	C	C	C	F	F	F	F	F	F	F	F	F	F	F	G
180 181	C	C	C	X	X	E	E	E	C	C	E	E	E	E	C	C	C	F	F	F	F	F	F	F	F	F	F	F	G
220 221	C	C	C	X	X	E	E	E	C	C	E	E	E	E	C	C	C	F	F	F	F	F	F	F	F	F	F	F	G
270 271	C	C	C	X	X	E	E	E	C	C	E	E	E	E	C	C	C	F	F	F	F	F	F	F	F	F	F	F	G
330 331	C	C	C	X	X	E	E	E	C	C	E	E	E	E	C	C	C	F	F	F	F	F	F	F	F	F	F	F	G
390 391	C	C	C	X	X	E	E	E	C	C	E	E	E	E	C	C	C	F	F	F	F	F	F	F	F	F	F	F	G
470 471	C	C	C	X	X	E	E	E	C	C	E	E	E	E	C	C	C	F	F	F	F	F	F	F	F	F	F	F	G
560 561	C	C	C	X	X	E	E	E	C	C	E	E	E	E	C	C	C	F	F	F	F	F	F	F	F	F	F	F	G
680 681	C	C	C	X	X	E	E	E	C	C	E	F	F	F	C	C	C	F	F	F	F	F	F	F	F	F	F	F	G
750 751	C	C	C	X	X	E	E	E	C	C	E	F	G	G	C	C	C	F	F	F	F	F	F	F	F	F	F	F	G
820 821	C	C	C	X	X	E	E	E	C	C	E	F	G	G	C	C	C	F	E	E	E	E	E	E	E	E	E	G	G
1000 102				E	E	E	E	E	C	C	E	E	E	E	C	C	C	F	E	E	E	E	E	E	E	E	E	E	G
1200 122				E	E	E	E	E	C	C	E	E	E	E	C	C	C	F	E	E	E	E	E	E	E	E	E	E	G
1500 152				E	E	E	E	E	C	C	E	E	E	E	C	C	C	F	E	E	E	E	E	E	E	E	E	E	G
1800 182				E	E	E	E	E	C	C	E	E	E	E	C	C	C	F	E	E	E	E	E	E	E	E	E	E	G
2200 222				E	E	E	E	E	E	E	E	E	E	E	C	C	C	F	E	E	E	E	E	E	E	E	E	E	G
2700 272				E	E	E	E	E	E	E	E	E	E	E	C	C	C	F	E	E	E	E	E	E	E	E	E	E	G
3300 332				E	E	E	E	E	E	E	E	E	E	E	C	C	C	F	E	E	E	E	E	E	E	E	E	E	G
3900 392				E	E	E	E	E	E	E	E	E	E	E	C	C	C	F	E	E	E	E	E	E	E	E	E	E	G
4700 472				E	E	E	E	E	E	E	E	E	E	E	C	C	C	F	E	E	E	E	E	E	E	E	E	E	G
5600 562				E	E	E	E	E	E	E	E	E	E	E	C	C	C	F	E	E	E	E	E	E	E	E	E	E	G
6800 682				E	E	E	E	E	E	E	E	E	E	E	C	C	C	F	E	E	E	E	E	E	E	E	E	E	G
8200 822				E	E	E	E	E	E	E	E	E	E	E	C	C	C	F	E	E	E	E	E	E	E	E	E	E	G
Cap (µF) 0.010 103				E	E	E	E	E	E	E	E	E	E	E	E	E	E	E	E	E	E	E	E	E	E	E	E	E	G
0.012 123				E	E	E	E	E	E	E	E	E	E	E	E	E	E	E	E	E	E	E	E	E	E	E	E	E	G
0.015 153				E	E	E	E	E	E	E	E	E	E	E	E	E	E	E	E	E	E	E	E	E	E	E	E	E	G
0.018 183				E	E	E	E	E	E	E	E	E	E	E	E	E	E	E	E	E	E	E	E	E	E	E	E	E	G
0.022 223				E	E	E	E	E	E	E	E	E	E	E	E	E	E	E	E	E	E	E	E	E	E	E	E	E	G
0.033 333				E	E	E	E	E	E	E	E	E	E	E	E	E	E	E	E	E	E	E	E	E	E	E	E	E	G
0.047 473				E	E	E	E	E	E	E	E	E	E	E	E	E	E	E	E	E	E	E	E	E	E	E	E	E	G
0.056 563				E	E	E	E	E	E	E	E	E	E	E	E	E	E	E	E	E	E	E	E	E	E	E	E	E	G
0.068 683				E	E	E	E	E	E	E	E	E	E	E	E	E	E	E	E	E	E	E	E	E	E	E	E	E	G
0.100 104				E	E	E	E	E	E	E	E	E	E	E	E	E	E	E	E	E	E	E	E	E	E	E	E	E	G
Voltage (V)	600	630	1000	600	630	1000	1500	2000	600	630	1000	1500	2000	600	630	1000	1500	2000	2500	3000	4000	600	630	1000	1500	2000	2500	3000	4000
Case Size	0805			1206				1210					1808							1812									

High Voltage MLC Chips FLEXITERM®

For 600V to 5000V Applications

NP0 (C0G) CAPACITANCE RANGE
PREFERRED SIZES ARE SHADED

Case Size	1825								2220								2225										
Soldering	Reflow Only								Reflow Only								Reflow Only										
(L) Length mm (in.)	4.60 ± 0.50 (0.181 ± 0.020)								5.70 ± 0.50 (0.224 ± 0.020)								5.72 ± 0.25 (0.225 ± 0.010)										
(W) Width mm (in.)	6.30 ± 0.40 (0.248 ± 0.016)								5.00 ± 0.40 (0.197 ± 0.016)								6.35 ± 0.25 (0.250 ± 0.010)										
(T) Thickness mm (in.)	3.40 (0.134)								3.40 (0.134)								2.54 (0.100)										
(t) Terminal min max	0.75 ± 0.35 (0.030 ± 0.014)								0.85 ± 0.35 (0.033 ± 0.014)								0.85 ± 0.35										
Voltage (V)	600	630	1000	1500	2000	2500	3000	4000	600	630	1000	1500	2000	2500	3000	4000	5000	600	630	1000	1500	2000	2500	3000	4000	5000	
Cap (pF) 1.5 1R5																											
1.8 1R8																											
2.2 2R2																											
2.7 2R7																											
3.3 3R3																											
3.9 3R9																											
4.7 4R7																											
5.6 5R6																											
6.8 6R8																											
8.2 8R2																											
10 100	E	E	E	E	E	E	E	E	E	E	E	E	E	E	E	E	E	E	E	E	E	E	E	E	F	F	
12 120	E	E	E	E	E	E	E	E	E	E	E	E	E	E	E	E	E	E	E	E	E	E	E	E	E	F	F
15 150	E	E	E	E	E	E	E	E	E	E	E	E	E	E	E	E	E	E	E	E	E	E	E	E	E	F	F
18 180	E	E	E	E	E	E	E	E	E	E	E	E	E	E	E	E	E	E	E	E	E	E	E	E	E	F	F
22 220	E	E	E	E	E	E	E	E	E	E	E	E	E	E	E	E	E	E	E	E	E	E	E	E	E	F	F
27 270	E	E	E	E	E	E	E	E	E	E	E	E	E	E	E	E	E	E	E	E	E	E	E	E	E	F	F
33 330	E	E	E	E	E	E	E	E	E	E	E	E	E	E	E	E	E	E	E	E	E	E	E	E	E	F	F
39 390	E	E	E	E	E	E	E	E	E	E	E	E	E	E	E	E	E	E	E	E	E	E	E	E	E	F	F
47 470	E	E	E	E	E	E	E	F	E	E	E	E	E	E	E	E	E	E	E	E	E	E	E	E	E	F	G
56 560	E	E	E	E	E	E	E	F	E	E	E	E	E	E	E	E	E	E	E	E	E	E	E	E	E	F	G
68 680	E	E	E	E	E	E	E	F	E	E	E	E	E	E	E	E	E	E	E	E	E	E	E	E	E	F	G
82 820	E	E	E	E	E	E	E	F	E	E	E	E	E	E	E	E	E	E	E	E	E	E	E	E	E	F	G
100 101	E	E	E	E	E	E	E	F	E	E	E	E	E	E	E	E	E	E	E	E	E	E	E	E	E	G	G
120 121	E	E	E	E	E	E	E	F	E	E	E	E	E	E	E	E	E	E	E	E	E	E	E	E	E	G	G
150 151	E	E	E	E	E	E	E	F	E	E	E	E	E	E	E	E	E	E	E	E	E	E	E	E	E	G	G
180 181	E	E	E	E	E	E	E	F	E	E	E	E	E	E	E	E	F	F	E	E	E	E	E	E	E	G	G
220 221	E	E	E	E	E	E	E	F	E	E	E	E	E	E	E	E	F	F	E	E	E	E	E	E	E	G	G
270 271	E	E	E	E	E	E	E	F	E	E	E	E	E	E	E											G	G
330 331	E	E	E	E	E	E	E	F	E	E	E	E	E	E												G	G
390 391	E	E	E	E	E	E	E		E	E	E	E	E	E												G	G
470 471	E	E	E	E	E	E	E		E	E	E	E	E	E												G	G
560 561	E	E	E	E	E	E	E		E	E	E	E	E	E												G	G
680 681	E	E	E	E	E	F	F		E	E	E	E	F	F													
750 751	E	E	E	E	E	F	F		E	E	E	E	F	F													
820 821	E	E	E	E	E	F	F		E	E	E	E	F	F													
1000 102	E	E	E	E	E	F	F		E	E	E	E	F	F													
1200 122	E	E	E	E	E	G	G		E	E	E	E	G	G												F	F
1500 152	E	E	E	F	F	G	G		E	E	E	F	F	G	G											F	F
1800 182	E	E	E	F	F	G	G		E	E	E	F	F	G	G											G	G
2200 222	E	E	E	G	G				E	E	E	G	G														
2700 272	E	E	E	G	G				E	E	E	G	G														
3300 332	E	E	E	G	G				E	E	E	G	G														
3900 392	E	E	E	G	G				E	E	E	G	G														
4700 472	E	E	E	G	G				E	E	E	G	G													F	F
5600 562	F	F	F	G	G				F	F	F	G	G													F	F
6800 682	F	F	F						F	F	F															G	G
8200 822	G	G	G						G	G	G																
Cap (µF) 0.010 103																											
0.012 123																											
0.015 153																											
0.018 183																											
0.022 223																											
0.033 333																											
0.047 473																											
0.056 563																											
0.068 683																											
0.100 104																											
Voltage (V)	600	630	1000	1500	2000	2500	3000	4000	600	630	1000	1500	2000	2500	3000	4000	5000	600	630	1000	1500	2000	2500	3000	4000	5000	
Case Size	1825								2220								2225										

Letter	A	C	E	F	G	X
Max. Thickness	0.813 (0.032)	1.448 (0.057)	1.8034 (0.071)	2.2098 (0.087)	2.794 (0.110)	0.940 (0.037)

NOTE: Contact factory for non-specified capacitance values

High Voltage MLC Chips FLEXITERM®

For 600V to 5000V Applications

X7R Dielectric Performance Characteristics

Capacitance Range	10 pF to 0.82 µF (25°C, 1.0 ±0.2 Vrms at 1kHz)
Capacitance Tolerances	±10%; ±20%; +80%, -20%
Dissipation Factor	2.5% max. (+25°C, 1.0 ±0.2 Vrms, 1kHz)
Operating Temperature Range	-55°C to +125°C
Temperature Characteristic	±15% (0 VDC)
Voltage Ratings	600, 630, 1000, 1500, 2000, 2500, 3000, 4000 & 5000 VDC (+125°C)
Insulation Resistance (+25°C, at 500 VDC)	100K MΩ min. or 1000 MΩ - µF min., whichever is less
Insulation Resistance (+125°C, at 500 VDC)	10K MΩ min. or 100 MΩ - µF min., whichever is less
Dielectric Strength	Minimum 120% rated voltage for 5 seconds at 50 mA max. current

X7R CAPACITANCE RANGE PREFERRED SIZES ARE SHADED

Case Size	0805			1206				1210				1808				1812															
	Soldering			Soldering				Soldering				Soldering				Soldering															
(L) Length	Reflow/Wave			Reflow/Wave				Reflow Only				Reflow Only				Reflow Only															
mm (in.)	2.10 ± 0.20 (0.083 ± 0.008)			3.30 ± 0.30 (0.130 ± 0.012)				3.30 ± 0.40 (0.130 ± 0.016)				4.60 ± 0.50 (0.181 ± 0.020)				4.60 ± 0.50 (0.181 ± 0.020)															
(W) Width	1.25 ± 0.20 (0.049 ± 0.008)			1.60 +0.30/-0.10 (0.063 +0.012/-0.004)				2.50 ± 0.30 (0.098 ± 0.012)				2.00 ± 0.20 (0.079 ± 0.008)				3.20 ± 0.30 (0.126 ± 0.012)															
(T) Thickness	1.35 (0.053)			1.80 (0.071)				2.80 (0.110)				2.20 (0.087)				2.80 (0.110)															
(t) Terminal	0.50 ± 0.20 (0.020 ± 0.008)			0.60 ± 0.20 (0.024 ± 0.008)				0.75 ± 0.35 (0.030 ± 0.014)				0.75 ± 0.35 (0.030 ± 0.014)				0.75 ± 0.35 (0.030 ± 0.014)															
min max																															
Voltage (V)	600	630	1000	600	630	1000	1500	2000	600	630	1000	1500	2000	600	630	1000	1500	2000	2500	3000	4000	600	630	1000	1500	2000	2500	3000	4000		
Cap (pF)	100	101	X	X	C	C	C	E	E	E	E	E	E																		
	120	121	X	X	C	C	C	E	E	E	E	E	E																		
	150	151	X	X	C	C	C	E	E	E	E	E	E																		
	180	181	X	X	C	C	C	E	E	E	E	E	E																		
	220	221	X	X	C	C	C	E	E	E	E	E	E																		
	270	271	X	X	C	C	C	E	E	E	E	E	E											E	E	E	E	E			
	330	331	X	X	C	C	C	E	E	E	E	E	E	E	E	E	E	E	E	E	F			E	E	E	E	E			
	390	391	X	X	C	C	C	E	E	E	E	E	E	E	E	E	E	E	E	E	F			E	E	E	E	E			
	470	471	X	X	C	C	C	E	E	E	E	E	E	E	E	E	E	E	E	F			E	E	E	E	E	E	E		
	560	561	X	X	C	C	C	E	E	E	E	E	E	E	E	E	E	E	E	F	F			E	E	E	E	E	E	E	
	680	681	X	X	C	C	C	E	E	E	E	E	E	E	E	E	E	E	E	F	F			E	E	E	E	E	F	F	
	750	751	X	X	C	C	C	E	E	E	E	E	E	E	E	E	E	E	E	F	F			E	E	E	E	E	F	F	
	820	821	X	X	C	C	C	E	E	E	E	E	E	E	E	E	E	E	E	F	F			E	E	E	E	E	F	F	
	1000	102	X	X	C	C	C	E	E	E	E	E	E	E	E	E	E	E	E	F	F			E	E	E	E	E	F	F	
	1200	122	X	X	C	C	C	E	E	E	E	E	E	E	E	E	E	E	E	F	F			E	E	E	E	E	F	F	
	1500	152	X	X	C	C	C	E	E	E	E	E	E	E	E	E	E	E	E	F	F			E	E	E	E	E	G	G	
	1800	182	X	X			C	C	E	E	E	E	E	E	E	E	E	E	E	F	F			E	E	E	E	E	G	G	
	2200	222	X	X			C	C	E	E	E	E	E	E	E	E	E	E	F	F			E	E	E	E	E	G	G		
	2700	272	X	X			C	C	E	E				E	E	E	F	E	E	E	F	F			E	E	E	E	E	G	G
	3300	332	X	X			C	C	E					E	E	E	F	E	E	E	F	F			E	E	E	F	F	G	G
	3900	392	X	X			C	C	E					E	E	E	G							E	E	E	F	F	G	G	
	4700	472	X	X			C	C	E					E	E	E	G							E	E	E	F	F	G	G	
	5600	562	X	X			C	C	E					E	E	E	G							E	E	E	G	G			
	6800	682	X	X			C	C	E					E	E	E								E	E	E	G	G			
	8200	822	X	X			C	C	E					E	E	E								E	E	E	G	G			
Cap (µF)	0.010	103	C	C			C	C	E					E	E	E								E	E	F	G	G			
	0.015	153	C	C			E	E	E					E	E	E								E	E	F	G				
	0.018	183	C	C			E	E	E					E	E	E								E	E	G					
	0.022	223	C	C			E	E						E	E	E								E	E	G					
	0.027	273					E	E						E	E									E	E	G					
	0.033	333					E	E						E	E									E	E	G					
	0.039	393												E	E									E	E	G					
	0.047	473												E	E									E	E	G					
	0.056	563												F	F									F	F						
	0.068	683												F	F									F	F						
	0.082	823												F	F									F	F						
	0.100	104												F	F									F	F						
	0.150	154																						G	G						
	0.220	224																						G	G						
	0.270	274																													
	0.330	334																													
	0.390	394																													
	0.470	474																													
	0.560	564																													
	0.680	684																													
	0.820	824																													
	1.000	105																													
Voltage (V)	600	630	1000	600	630	1000	1500	2000	600	630	1000	1500	2000	600	630	1000	1500	2000	2500	3000	4000	600	630	1000	1500	2000	2500	3000	4000		
Case Size	0805			1206				1210				1808				1812															

High Voltage MLC Chips FLEXITERM®

For 600V to 5000V Applications

X7R CAPACITANCE RANGE PREFERRED SIZES ARE SHADED

Case Size	1825								2220								2225									
Soldering	Reflow Only								Reflow Only								Reflow Only									
(L) Length mm (in.)	4.60 ± 0.50 (0.181 ± 0.020)								5.70 ± 0.50 (0.224 ± 0.020)								5.72 ± 0.25 (0.225 ± 0.010)									
(W) Width mm (in.)	6.30 ± 0.40 (0.248 ± 0.016)								5.00 ± 0.40 (0.197 ± 0.016)								6.35 ± 0.25 (0.250 ± 0.010)									
(T) Thickness mm (in.)	3.40 (0.134)								3.40 (0.134)								2.54 (0.100)									
(t) Terminal min max	0.75 ± 0.35 (0.030 ± 0.014)								0.85 ± 0.35 (0.033 ± 0.014)								0.85 ± 0.35									
Voltage (V)	600	630	1000	1500	2000	2500	3000	4000	600	630	1000	1500	2000	2500	3000	4000	5000	600	630	1000	1500	2000	2500	3000	4000	5000
Cap (pF) 100 101																										
120 121																										
150 151																										
180 181																										
220 221																										
270 271																										
330 331																										
390 391																										
470 471																										
560 561																										
680 681																										
750 751																										
820 821																										
1000 102	F	F	F	F	F	F	F	F	F	F	F	F	F	F	F	G		F	F	F	F	F	F	F	F	F
1200 122	F	F	F	F	F	F	F	F	F	F	F	F	F	F	F	G		F	F	F	F	F	F	F	F	F
1500 152	F	F	F	F	F	F	F	F	F	F	F	F	F	F	F	G		F	F	F	F	F	F	F	F	F
1800 182	F	F	F	F	F	F	F	F	F	F	F	F	F	F	F	G		F	F	F	F	F	F	F	F	F
2200 222	F	F	F	F	F	F	F	F	F	F	F	F	F	F	F	G		F	F	F	F	F	F	F	F	F
2700 272	F	F	F	F	F	F	F	F	F	F	F	F	F	F	F	G		F	F	F	F	F	F	F	F	F
3300 332	F	F	F	F	F	F	F	F	F	F	F	F	F	F	F	G		F	F	F	F	F	F	F	F	F
3900 392	F	F	F	F	F	F	F	F	F	F	F	F	F	F	F	G		F	F	F	F	F	F	F	F	F
4700 472	F	F	F	F	F	F	F	F	F	F	F	F	F	F	F	G		F	F	F	F	F	F	F	F	F
5600 562	F	F	F	F	F	F	F	F	F	F	F	F	F	F	F	G		F	F	F	F	F	F	F	F	F
6800 682	F	F	F	G	G	G	G	G	F	F	F	F	F	F	F	G	G	F	F	F	F	F	F	F	F	G
8200 822	F	F	F	G	G	G	G	G	F	F	F	G	G	G	G	G		F	F	F	F	F	G	G	G	G
Cap (µF) 0.010 103	F	F	F	G	G	G	G	G	F	F	F	G	G	G	G	G		F	F	F	F	F	G	G	G	G
0.015 153	F	F	F	G	G	G	G		F	F	F	G	G	G	G		F	F	F	G	G	G	G	G	G	G
0.018 183	F	F	F	G	G				F	F	F	G	G	G			F	F	F	G	G	G	G			
0.022 223	F	F	F	G	G				F	F	F	G	G				F	F	F	G	G	G	G			
0.027 273	F	F	F	G					F	F	F	G	G				F	F	F	G	G					
0.033 333	F	F	F	G					F	F	F	G					F	F	F	G	G					
0.039 393	F	F	F	G					F	F	F	G					F	F	F	G						
0.047 473	F	F	F	P					F	F	F	G					F	F	F	G						
0.056 563	F	F	F	G					F	F	F	G					F	F	F	G						
0.068 683	F	F	G						F	F	G						F	F	F	G						
0.082 823	F	F	G						F	F	G						F	F	G							
0.100 104	F	F	G						F	F	G						F	F	G							
0.150 154	F	F							F	F	G						F	F	G							
0.220 224	F	F							F	F	G						F	F								
0.270 274	F	F							F	F							F	F								
0.330 334	F	F							F	F							F	F								
0.390 394	F	F							F	F							F	F								
0.470 474	F	F							F	F							F	F								
0.560 564	G	G							G	G							F	F								
0.680 684									G	G							G	G								
0.820 824																	G	G								
1.000 105																										
Voltage (V)	600	630	1000	1500	2000	2500	3000	4000	600	630	1000	1500	2000	2500	3000	4000	5000	600	630	1000	1500	2000	2500	3000	4000	5000

Letter	A	C	E	F	G	P	X
Max. Thickness	0.813 (0.032)	1.448 (0.057)	1.8034 (0.071)	2.2098 (0.087)	2.794 (0.110)	3.048 (0.120)	0.940 (0.037)

NOTE: Contact factory for non-specified capacitance values

High Voltage MLC Chip Capacitors

For 600V to 3000V Automotive Applications – AEC-Q200

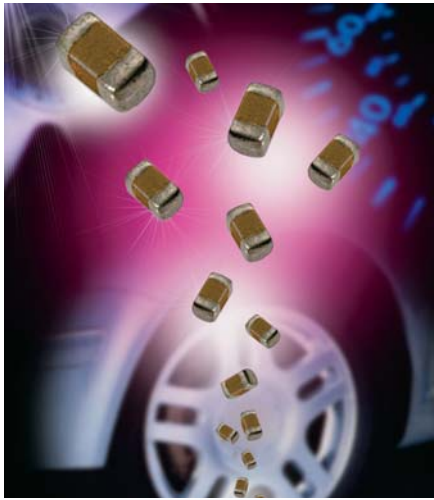

Modern automotive electronics could require components capable to work with high voltage (e.g. xenon lamp circuits or power converters in hybrid cars). AVX offer high voltage ceramic capacitors qualified according to AEC-Q200 standard.

High value, low leakage and small size are difficult parameters to obtain in capacitors for high voltage systems. AVX special high voltage MLC chip capacitors meet these performance characteristics and are designed for applications such as snubbers in high frequency power converters, resonators in SMPS, and high voltage coupling / dc blocking. These high voltage chip designs exhibit low ESRs at high frequencies.

Due to high voltage nature, larger physical dimensions are necessary. These larger sizes require special precautions to be taken in applying of MLC chips. The temperature gradient during heating or cooling cycles should not exceed 4°C per second. The preheat temperature must be within 50°C of the peak temperature reached by the ceramic bodies through the soldering process. Chip sizes 1210 and larger should be reflow soldered only. Capacitors may require protective surface coating to prevent external arcing.

To improve mechanical and thermal resistance, AVX recommend to use flexible terminations system - FLEXITERM®.

HOW TO ORDER

1210	C	C	223	K	4	T	1	A
AVX Style	Voltage	Dielectric	Capacitance Code	Capacitance Tolerance	Failure Rate	Termination	Packaging	Special Code
1206	C = 630V A = 1000V S = 1500V G = 2000V W = 2500V H = 3000V	C = X7R	(2 significant digits + no. of zeros) e.g. 103 = 10nF (223 = 22nF)	J = ±5% K = ±10% M = ±20%	4 = Automotive	T = Plated Ni/Sn Z = FLEXITERM®	1 or 2 = 7" Reel 3 or 4 = 13" Reel	A = Standard
1210								
1808								
1812								
2220								

*AVX offers nonstandard case sizes. Contact factory for details.

Notes: Capacitors with X7R dielectrics are not intended for applications across AC supply mains or AC line filtering with polarity reversal. Please contact AVX for recommendations.

CHIP DIMENSIONS DESCRIPTION (See capacitance range chart on page 106)

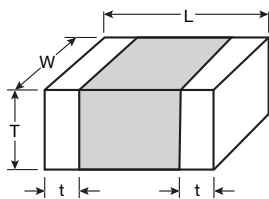

L = Length
W = Width
T = Thickness
t = Terminal

X7R DIELECTRIC PERFORMANCE CHARACTERISTICS

Parameter/Test	Specification Limits	Measuring Conditions
Operating Temperature Range	-55°C to +125°C	Temperature Cycle Chamber
Capacitance Dissipation Factor Capacitance Tolerance	within specified tolerance 2.5% max. ±5% (J), ±10% (K), ±20% (M)	Freq.: 1kHz ±10% Voltage: 1.0Vrms ±0.2Vrms T = +25°C, V = 0Vdc
Temperature Characteristics	X7R = ±15%	Vdc = 0V, T = (-55°C to +125°C)
Insulation Resistance	100GΩ min. or 1000MΩ • μF min. (whichever is less) 10GΩ min. or 100MΩ • μF min. (whichever is less)	T = +25°C, V = 500Vdc T = +125°C, V = 500Vdc (t ≥ 120 sec, I ≤ 50mA)
Dielectric Strength	No breakdown or visual defect	120% of rated voltage t ≤ 5 sec, I ≤ 50mA

High Voltage MLC Chip Capacitors

For 600V to 3000V Automotive Applications – AEC-Q200

X7R CAPACITANCE RANGE PREFERRED SIZES ARE SHADED

Case Size		1206					1210				1808				1812					2220						
Soldering		Reflow/Wave					Reflow Only				Reflow Only				Reflow Only					Reflow Only						
(L) Length	mm (in.)	3.20 ± 0.20 (0.126 ± 0.008)					3.20 ± 0.20 (0.126 ± 0.008)				4.57 ± 0.25 (0.180 ± 0.010)				4.50 ± 0.30 (0.177 ± 0.012)					5.70 ± 0.40 (0.224 ± 0.016)						
(W) Width	mm (in.)	1.60 ± 0.20 (0.063 ± 0.008)					2.50 ± 0.20 (0.098 ± 0.008)				2.03 ± 0.25 (0.080 ± 0.010)				3.20 ± 0.20 (0.126 ± 0.008)					5.00 ± 0.40 (0.197 ± 0.016)						
(T) Thickness	mm (in.)	1.52 (0.060)					1.70 (0.067)				2.03 (0.080)				2.54 (0.100)					3.30 (0.130)						
(t) Terminal	min max	0.25 (0.010) 0.75 (0.030)					0.25 (0.010) 0.75 (0.030)				0.25 (0.010) 1.02 (0.040)				0.25 (0.010) 1.02 (0.040)					0.25 (0.010) 1.02 (0.040)						
Voltage (V)		630	1000	1500	2000	2500	630	1000	1500	2000	630	1000	1500	2000	2500	3000	630	1000	1500	2000	2500	3000	630	1000	1500	2000
Cap (pF)	100	101																								
	120	121																								
	150	151																								
	180	181																								
	220	221																								
	270	271																								
	330	331																								
	390	391																								
	470	471																								
	560	561																								
	680	681																								
	820	821																								
	1000	102																								
	1200	122																								
	1500	152																								
	1800	182																								
	2200	222																								
	2700	272																								
	3300	332																								
	3900	392																								
	4700	472																								
	5600	562																								
	6800	682																								
	8200	822																								
Cap (µF)	0.01	103																								
	0.012	123																								
	0.015	153																								
	0.018	183																								
	0.022	223																								
	0.027	273																								
	0.033	333																								
	0.039	393																								
	0.047	473																								
	0.056	563																								
	0.068	683																								
	0.082	823																								
	0.100	104																								
	0.120	124																								
	0.150	154																								
Voltage (V)		630	1000	1500	2000	2500	630	1000	1500	2000	630	1000	1500	2000	2500	3000	630	1000	1500	2000	2500	3000	630	1000	1500	2000
Case Size		1206					1210				1808				1812					2220						

NOTE: Contact factory for non-specified capacitance values

MIL-PRF-55681/Chips

Part Number Example CDR01 thru CDR06

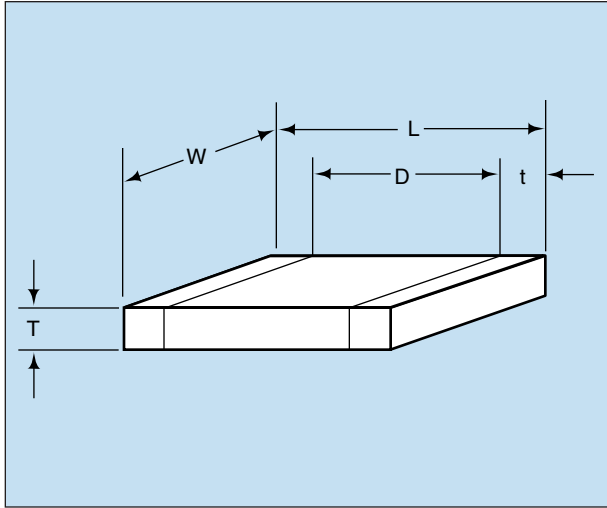

MILITARY DESIGNATION PER MIL-PRF-55681

Part Number Example

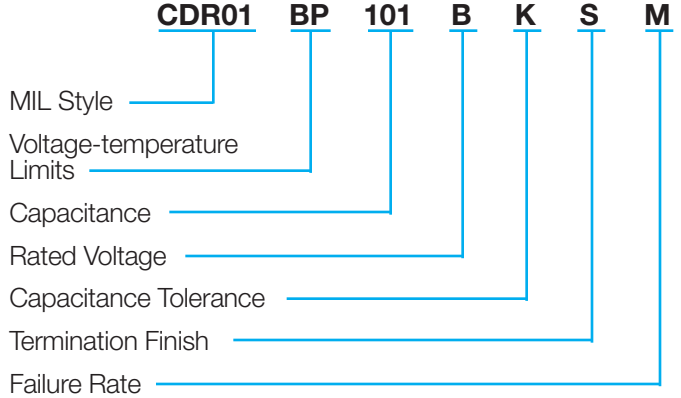

NOTE: Contact factory for availability of Termination and Tolerance Options for Specific Part Numbers.

MIL Style: CDR01, CDR02, CDR03, CDR04, CDR05, CDR06

Voltage Temperature Limits:

BP = 0 ± 30 ppm/°C without voltage; 0 ± 30 ppm/°C with rated voltage from -55°C to +125°C

BX = ±15% without voltage; +15 -25% with rated voltage from -55°C to +125°C

Capacitance: Two digit figures followed by multiplier (number of zeros to be added) e.g., 101 = 100 pF

Rated Voltage: A = 50V, B = 100V

Capacitance Tolerance: J ± 5%, K ± 10%, M ± 20%

Termination Finish:

- M = Palladium silver
- N = Silver-nickel-gold
- S = Solder coated final with a minimum of 4 percent lead
- T = Silver
- U = Base metallization-barrier metal-solder coated (tin/lead alloy, with a minimum of 4 percent lead)
- W = Base metallization-barrier metal-tinned (tin or tin/lead alloy)
- Y = Base metallization-barrier metal-tin (100 percent)
- Z = Base metallization-barrier metal-tinned (tin/lead alloy, with a minimum of 4 percent lead)

*See MIL-PRF-55681 Specification for more details

Failure Rate Level: M = 1.0%, P = .1%, R = .01%, S = .001%

Packaging: Bulk is standard packaging. Tape and reel per RS481 is available upon request.

Not RoHS Compliant

CROSS REFERENCE: AVX/MIL-PRF-55681/CDR01 THRU CDR06*

Per MIL-PRF-55681	AVX Style	Length (L)	Width (W)	Thickness (T)		D		Termination Band (t)	
				Min.	Max.	Min.	Max.	Min.	Max.
CDR01	0805	.080 ± .015	.050 ± .015	.022	.055	.030	—	.010	—
CDR02	1805	.180 ± .015	.050 ± .015	.022	.055	—	—	.010	.030
CDR03	1808	.180 ± .015	.080 ± .018	.022	.080	—	—	.010	.030
CDR04	1812	.180 ± .015	.125 ± .015	.022	.080	—	—	.010	.030
CDR05	1825	.180 ^{+0.020} _{-.015}	.250 ^{+0.020} _{-.015}	.020	.080	—	—	.010	.030
CDR06	2225	.225 ± .020	.250 ± .020	.020	.080	—	—	.010	.030

*For CDR11, 12, 13, and 14 see AVX Microwave Chip Capacitor Catalog

MIL-PRF-55681/Chips

Military Part Number Identification

CDR01 thru CDR06

CDR01 thru CDR06 to MIL-PRF-55681

Military Type Designation	Capacitance in pF	Capacitance tolerance	Rated temperature and voltage-temperature limits	WVDC
AVX Style 0805/CDR01				
CDR01BP100B---	10	J,K	BP	100
CDR01BP120B---	12	J	BP	100
CDR01BP150B---	15	J,K	BP	100
CDR01BP180B---	18	J	BP	100
CDR01BP220B---	22	J,K	BP	100
CDR01BP270B---	27	J	BP	100
CDR01BP330B---	33	J,K	BP	100
CDR01BP390B---	39	J	BP	100
CDR01BP470B---	47	J,K	BP	100
CDR01BP560B---	56	J	BP	100
CDR01BP680B---	68	J,K	BP	100
CDR01BP820B---	82	J	BP	100
CDR01BP101B---	100	J,K	BP	100
CDR01B--121B---	120	J,K	BP,BX	100
CDR01B--151B---	150	J,K	BP,BX	100
CDR01B--181B---	180	J,K	BP,BX	100
CDR01BX221B---	220	K,M	BX	100
CDR01BX271B---	270	K	BX	100
CDR01BX331B---	330	K,M	BX	100
CDR01BX391B---	390	K	BX	100
CDR01BX471B---	470	K,M	BX	100
CDR01BX561B---	560	K	BX	100
CDR01BX681B---	680	K,M	BX	100
CDR01BX821B---	820	K	BX	100
CDR01BX102B---	1000	K,M	BX	100
CDR01BX122B---	1200	K	BX	100
CDR01BX152B---	1500	K,M	BX	100
CDR01BX182B---	1800	K	BX	100
CDR01BX222B---	2200	K,M	BX	100
CDR01BX272B---	2700	K	BX	100
CDR01BX332B---	3300	K,M	BX	100
CDR01BX392A---	3900	K	BX	50
CDR01BX472A---	4700	K,M	BX	50
AVX Style 1805/CDR02				
CDR02BP221B---	220	J,K	BP	100
CDR02BP271B---	270	J	BP	100
CDR02BX392B---	3900	K	BX	100
CDR02BX472B---	4700	K,M	BX	100
CDR02BX562B---	5600	K	BX	100
CDR02BX682B---	6800	K,M	BX	100
CDR02BX822B---	8200	K	BX	100
CDR02BX103B---	10,000	K,M	BX	100
CDR02BX123A---	12,000	K	BX	50
CDR02BX153A---	15,000	K,M	BX	50
CDR02BX183A---	18,000	K	BX	50
CDR02BX223A---	22,000	K,M	BX	50

- Add appropriate failure rate
- Add appropriate termination finish
- Capacitance Tolerance

Military Type Designation	Capacitance in pF	Capacitance tolerance	Rated temperature and voltage-temperature limits	WVDC
AVX Style 1808/CDR03				
CDR03BP331B---	330	J,K	BP	100
CDR03BP391B---	390	J	BP	100
CDR03BP471B---	470	J,K	BP	100
CDR03BP561B---	560	J	BP	100
CDR03BP681B---	680	J,K	BP	100
CDR03BP821B---	820	J	BP	100
CDR03BP102B---	1000	J,K	BP	100
CDR03BX123B---	12,000	K	BX	100
CDR03BX153B---	15,000	K,M	BX	100
CDR03BX183B---	18,000	K	BX	100
CDR03BX223B---	22,000	K,M	BX	100
CDR03BX273B---	27,000	K	BX	100
CDR03BX333B---	33,000	K,M	BX	100
CDR03BX393A---	39,000	K	BX	50
CDR03BX473A---	47,000	K,M	BX	50
CDR03BX563A---	56,000	K	BX	50
CDR03BX683A---	68,000	K,M	BX	50
AVX Style 1812/CDR04				
CDR04BP122B---	1200	J	BP	100
CDR04BP152B---	1500	J,K	BP	100
CDR04BP182B---	1800	J	BP	100
CDR04BP222B---	2200	J,K	BP	100
CDR04BP272B---	2700	J	BP	100
CDR04BP332B---	3300	J,K	BP	100
CDR04BX393B---	39,000	K	BX	100
CDR04BX473B---	47,000	K,M	BX	100
CDR04BX563B---	56,000	K	BX	100
CDR04BX823A---	82,000	K	BX	50
CDR04BX104A---	100,000	K,M	BX	50
CDR04BX124A---	120,000	K	BX	50
CDR04BX154A---	150,000	K,M	BX	50
CDR04BX184A---	180,000	K	BX	50
AVX Style 1825/CDR05				
CDR05BP392B---	3900	J,K	BP	100
CDR05BP472B---	4700	J,K	BP	100
CDR05BP562B---	5600	J,K	BP	100
CDR05BX683B---	68,000	K,M	BX	100
CDR05BX823B---	82,000	K	BX	100
CDR05BX104B---	100,000	K,M	BX	100
CDR05BX124B---	120,000	K	BX	100
CDR05BX154B---	150,000	K,M	BX	100
CDR05BX224A---	220,000	K,M	BX	50
CDR05BX274A---	270,000	K	BX	50
CDR05BX334A---	330,000	K,M	BX	50
AVX Style 2225/CDR06				
CDR06BP682B---	6800	J,K	BP	100
CDR06BP822B---	8200	J,K	BP	100
CDR06BP103B---	10,000	J,K	BP	100
CDR06BX394A---	390,000	K	BX	50
CDR06BX474A---	470,000	K,M	BX	50

- Add appropriate failure rate
- Add appropriate termination finish
- Capacitance Tolerance

MIL-PRF-55681/Chips

Part Number Example

CDR31 thru CDR35

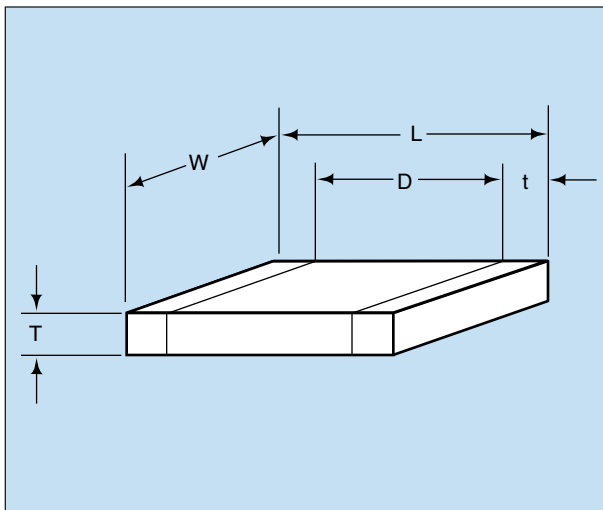

MILITARY DESIGNATION PER MIL-PRF-55681

Part Number Example

(example) **CDR31 BP 101 B K S M**

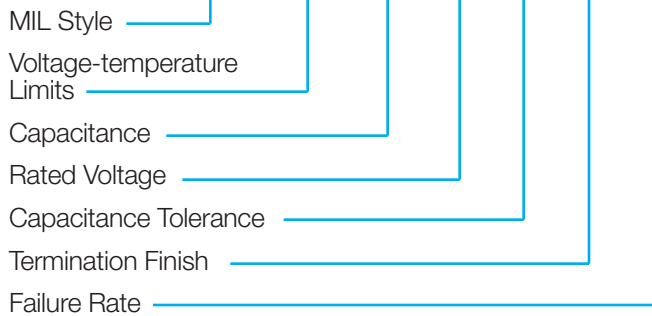

NOTE: Contact factory for availability of Termination and Tolerance Options for Specific Part Numbers.

MIL Style: CDR31, CDR32, CDR33, CDR34, CDR35

Voltage Temperature Limits:

BP = 0 ± 30 ppm/ $^{\circ}\text{C}$ without voltage; 0 ± 30 ppm/ $^{\circ}\text{C}$ with rated voltage from -55°C to $+125^{\circ}\text{C}$

BX = $\pm 15\%$ without voltage; $+15 -25\%$ with rated voltage from -55°C to $+125^{\circ}\text{C}$

Capacitance: Two digit figures followed by multiplier (number of zeros to be added) e.g., 101 = 100 pF

Rated Voltage: A = 50V, B = 100V

Capacitance Tolerance: B $\pm .10$ pF, C $\pm .25$ pF, D $\pm .5$ pF, F $\pm 1\%$, J $\pm 5\%$, K $\pm 10\%$, M $\pm 20\%$

Termination Finish:

Termination Finish:

M = Palladium silver

N = Silver-nickel-gold

S = Solder coated final with a minimum of 4 percent lead

T = Silver

U = Base metallization-barrier metal-solder coated (tin/lead alloy, with a minimum of 4 percent lead)

W = Base metallization-barrier metal-tinned (tin or tin/lead alloy)

Y = Base metallization-barrier metal-tin (100 percent)

Z = Base metallization-barrier metal-tinned (tin/lead alloy, with a minimum of 4 percent lead)

*See MIL-PRF-55681 Specification for more details

Failure Rate Level: M = 1.0%, P = .1%, R = .01%, S = .001%

Not RoHS Compliant

Packaging: Bulk is standard packaging. Tape and reel per RS481 is available upon request.

CROSS REFERENCE: AVX/MIL-PRF-55681/CDR31 THRU CDR35

Per MIL-PRF-55681 (Metric Sizes)	AVX Style	Length (L) (mm)	Width (W) (mm)	Thickness (T)	D	Termination Band (t)	
				Max. (mm)	Min. (mm)	Max. (mm)	Min. (mm)
CDR31	0805	2.00	1.25	1.3	.50	.70	.30
CDR32	1206	3.20	1.60	1.3	—	.70	.30
CDR33	1210	3.20	2.50	1.5	—	.70	.30
CDR34	1812	4.50	3.20	1.5	—	.70	.30
CDR35	1825	4.50	6.40	1.5	—	.70	.30

MIL-PRF-55681/Chips

Military Part Number Identification CDR31

CDR31 to MIL-PRF-55681/7

Military Type Designation 1/	Capacitance in pF	Capacitance tolerance	Rated temperature and voltage-temperature limits	WVDC
AVX Style 0805/CDR31 (BP)				
CDR31BP1R0B---	1.0	B,C	BP	100
CDR31BP1R1B---	1.1	B,C	BP	100
CDR31BP1R2B---	1.2	B,C	BP	100
CDR31BP1R3B---	1.3	B,C	BP	100
CDR31BP1R5B---	1.5	B,C	BP	100
CDR31BP1R6B---	1.6	B,C	BP	100
CDR31BP1R8B---	1.8	B,C	BP	100
CDR31BP2R0B---	2.0	B,C	BP	100
CDR31BP2R2B---	2.2	B,C	BP	100
CDR31BP2R4B---	2.4	B,C	BP	100
CDR31BP2R7B---	2.7	B,C,D	BP	100
CDR31BP3R0B---	3.0	B,C,D	BP	100
CDR31BP3R3B---	3.3	B,C,D	BP	100
CDR31BP3R6B---	3.6	B,C,D	BP	100
CDR31BP3R9B---	3.9	B,C,D	BP	100
CDR31BP4R3B---	4.3	B,C,D	BP	100
CDR31BP4R7B---	4.7	B,C,D	BP	100
CDR31BP5R1B---	5.1	B,C,D	BP	100
CDR31BP5R6B---	5.6	B,C,D	BP	100
CDR31BP6R2B---	6.2	B,C,D	BP	100
CDR31BP6R8B---	6.8	B,C,D	BP	100
CDR31BP7R5B---	7.5	B,C,D	BP	100
CDR31BP8R2B---	8.2	B,C,D	BP	100
CDR31BP9R1B---	9.1	B,C,D	BP	100
CDR31BP100B---	10	F,J,K	BP	100
CDR31BP110B---	11	F,J,K	BP	100
CDR31BP120B---	12	F,J,K	BP	100
CDR31BP130B---	13	F,J,K	BP	100
CDR31BP150B---	15	F,J,K	BP	100
CDR31BP160B---	16	F,J,K	BP	100
CDR31BP180B---	18	F,J,K	BP	100
CDR31BP200B---	20	F,J,K	BP	100
CDR31BP220B---	22	F,J,K	BP	100
CDR31BP240B---	24	F,J,K	BP	100
CDR31BP270B---	27	F,J,K	BP	100
CDR31BP300B---	30	F,J,K	BP	100
CDR31BP330B---	33	F,J,K	BP	100
CDR31BP360B---	36	F,J,K	BP	100
CDR31BP390B---	39	F,J,K	BP	100
CDR31BP430B---	43	F,J,K	BP	100
CDR31BP470B---	47	F,J,K	BP	100
CDR31BP510B---	51	F,J,K	BP	100
CDR31BP560B---	56	F,J,K	BP	100
CDR31BP620B---	62	F,J,K	BP	100
CDR31BP680B---	68	F,J,K	BP	100
CDR31BP750B---	75	F,J,K	BP	100
CDR31BP820B---	82	F,J,K	BP	100
CDR31BP910B---	91	F,J,K	BP	100

— Add appropriate failure rate
 — Add appropriate termination finish
 — Capacitance Tolerance

Military Type Designation 1/	Capacitance in pF	Capacitance tolerance	Rated temperature and voltage-temperature limits	WVDC
AVX Style 0805/CDR31 (BP) cont'd				
CDR31BP101B---	100	F,J,K	BP	100
CDR31BP111B---	110	F,J,K	BP	100
CDR31BP121B---	120	F,J,K	BP	100
CDR31BP131B---	130	F,J,K	BP	100
CDR31BP151B---	150	F,J,K	BP	100
CDR31BP161B---	160	F,J,K	BP	100
CDR31BP181B---	180	F,J,K	BP	100
CDR31BP201B---	200	F,J,K	BP	100
CDR31BP221B---	220	F,J,K	BP	100
CDR31BP241B---	240	F,J,K	BP	100
CDR31BP271B---	270	F,J,K	BP	100
CDR31BP301B---	300	F,J,K	BP	100
CDR31BP331B---	330	F,J,K	BP	100
CDR31BP361B---	360	F,J,K	BP	100
CDR31BP391B---	390	F,J,K	BP	100
CDR31BP431B---	430	F,J,K	BP	100
CDR31BP471B---	470	F,J,K	BP	100
CDR31BP511A---	510	F,J,K	BP	50
CDR31BP561A---	560	F,J,K	BP	50
CDR31BP621A---	620	F,J,K	BP	50
CDR31BP681A---	680	F,J,K	BP	50
AVX Style 0805/CDR31 (BX)				
CDR31BX471B---	470	K,M	BX	100
CDR31BX561B---	560	K,M	BX	100
CDR31BX681B---	680	K,M	BX	100
CDR31BX821B---	820	K,M	BX	100
CDR31BX102B---	1,000	K,M	BX	100
CDR31BX122B---	1,200	K,M	BX	100
CDR31BX152B---	1,500	K,M	BX	100
CDR31BX182B---	1,800	K,M	BX	100
CDR31BX222B---	2,200	K,M	BX	100
CDR31BX272B---	2,700	K,M	BX	100
CDR31BX332B---	3,300	K,M	BX	100
CDR31BX392B---	3,900	K,M	BX	100
CDR31BX472B---	4,700	K,M	BX	100
CDR31BX562A---	5,600	K,M	BX	50
CDR31BX682A---	6,800	K,M	BX	50
CDR31BX822A---	8,200	K,M	BX	50
CDR31BX103A---	10,000	K,M	BX	50
CDR31BX123A---	12,000	K,M	BX	50
CDR31BX153A---	15,000	K,M	BX	50
CDR31BX183A---	18,000	K,M	BX	50

— Add appropriate failure rate
 — Add appropriate termination finish
 — Capacitance Tolerance

1/ The complete part number will include additional symbols to indicate capacitance tolerance, termination and failure rate level.

MIL-PRF-55681/Chips

Military Part Number Identification CDR32

CDR32 to MIL-PRF-55681/8

Military Type Designation ^{1/}	Capacitance in pF	Capacitance tolerance	Rated temperature and voltage-temperature limits	WVDC
AVX Style 1206/CDR32 (BP)				
CDR32BP1R0B---	1.0	B,C	BP	100
CDR32BP1R1B---	1.1	B,C	BP	100
CDR32BP1R2B---	1.2	B,C	BP	100
CDR32BP1R3B---	1.3	B,C	BP	100
CDR32BP1R5B---	1.5	B,C	BP	100
CDR32BP1R6B---	1.6	B,C	BP	100
CDR32BP1R8B---	1.8	B,C	BP	100
CDR32BP2R0B---	2.0	B,C	BP	100
CDR32BP2R2B---	2.2	B,C	BP	100
CDR32BP2R4B---	2.4	B,C	BP	100
CDR32BP2R7B---	2.7	B,C,D	BP	100
CDR32BP3R0B---	3.0	B,C,D	BP	100
CDR32BP3R3B---	3.3	B,C,D	BP	100
CDR32BP3R6B---	3.6	B,C,D	BP	100
CDR32BP3R9B---	3.9	B,C,D	BP	100
CDR32BP4R3B---	4.3	B,C,D	BP	100
CDR32BP4R7B---	4.7	B,C,D	BP	100
CDR32BP5R1B---	5.1	B,C,D	BP	100
CDR32BP5R6B---	5.6	B,C,D	BP	100
CDR32BP6R2B---	6.2	B,C,D	BP	100
CDR32BP6R8B---	6.8	B,C,D	BP	100
CDR32BP7R5B---	7.5	B,C,D	BP	100
CDR32BP8R2B---	8.2	B,C,D	BP	100
CDR32BP9R1B---	9.1	B,C,D	BP	100
CDR32BP100B---	10	F,J,K	BP	100
CDR32BP110B---	11	F,J,K	BP	100
CDR32BP120B---	12	F,J,K	BP	100
CDR32BP130B---	13	F,J,K	BP	100
CDR32BP150B---	15	F,J,K	BP	100
CDR32BP160B---	16	F,J,K	BP	100
CDR32BP180B---	18	F,J,K	BP	100
CDR32BP200B---	20	F,J,K	BP	100
CDR32BP220B---	22	F,J,K	BP	100
CDR32BP240B---	24	F,J,K	BP	100
CDR32BP270B---	27	F,J,K	BP	100
CDR32BP300B---	30	F,J,K	BP	100
CDR32BP330B---	33	F,J,K	BP	100
CDR32BP360B---	36	F,J,K	BP	100
CDR32BP390B---	39	F,J,K	BP	100
CDR32BP430B---	43	F,J,K	BP	100
CDR32BP470B---	47	F,J,K	BP	100
CDR32BP510B---	51	F,J,K	BP	100
CDR32BP560B---	56	F,J,K	BP	100
CDR32BP620B---	62	F,J,K	BP	100
CDR32BP680B---	68	F,J,K	BP	100
CDR32BP750B---	75	F,J,K	BP	100
CDR32BP820B---	82	F,J,K	BP	100
CDR32BP910B---	91	F,J,K	BP	100

- Add appropriate failure rate
- Add appropriate termination finish
- Capacitance Tolerance

Military Type Designation ^{1/}	Capacitance in pF	Capacitance tolerance	Rated temperature and voltage-temperature limits	WVDC
AVX Style 1206/CDR32 (BP) cont'd				
CDR32BP101B---	100	F,J,K	BP	100
CDR32BP111B---	110	F,J,K	BP	100
CDR32BP121B---	120	F,J,K	BP	100
CDR32BP131B---	130	F,J,K	BP	100
CDR32BP151B---	150	F,J,K	BP	100
CDR32BP161B---	160	F,J,K	BP	100
CDR32BP181B---	180	F,J,K	BP	100
CDR32BP201B---	200	F,J,K	BP	100
CDR32BP221B---	220	F,J,K	BP	100
CDR32BP241B---	240	F,J,K	BP	100
CDR32BP271B---	270	F,J,K	BP	100
CDR32BP301B---	300	F,J,K	BP	100
CDR32BP331B---	330	F,J,K	BP	100
CDR32BP361B---	360	F,J,K	BP	100
CDR32BP391B---	390	F,J,K	BP	100
CDR32BP431B---	430	F,J,K	BP	100
CDR32BP471B---	470	F,J,K	BP	100
CDR32BP511B---	510	F,J,K	BP	100
CDR32BP561B---	560	F,J,K	BP	100
CDR32BP621B---	620	F,J,K	BP	100
CDR32BP681B---	680	F,J,K	BP	100
CDR32BP751B---	750	F,J,K	BP	100
CDR32BP821B---	820	F,J,K	BP	100
CDR32BP911B---	910	F,J,K	BP	100
CDR32BP102B---	1,000	F,J,K	BP	100
CDR32BP112A---	1,100	F,J,K	BP	50
CDR32BP122A---	1,200	F,J,K	BP	50
CDR32BP132A---	1,300	F,J,K	BP	50
CDR32BP152A---	1,500	F,J,K	BP	50
CDR32BP162A---	1,600	F,J,K	BP	50
CDR32BP182A---	1,800	F,J,K	BP	50
CDR32BP202A---	2,000	F,J,K	BP	50
CDR32BP222A---	2,200	F,J,K	BP	50
AVX Style 1206/CDR32 (BX)				
CDR32BX472B---	4,700	K,M	BX	100
CDR32BX562B---	5,600	K,M	BX	100
CDR32BX682B---	6,800	K,M	BX	100
CDR32BX822B---	8,200	K,M	BX	100
CDR32BX103B---	10,000	K,M	BX	100
CDR32BX123B---	12,000	K,M	BX	100
CDR32BX153B---	15,000	K,M	BX	100
CDR32BX183A---	18,000	K,M	BX	50
CDR32BX223A---	22,000	K,M	BX	50
CDR32BX273A---	27,000	K,M	BX	50
CDR32BX333A---	33,000	K,M	BX	50
CDR32BX393A---	39,000	K,M	BX	50

- Add appropriate failure rate
- Add appropriate termination finish
- Capacitance Tolerance

^{1/} The complete part number will include additional symbols to indicate capacitance tolerance, termination and failure rate level.

MIL-PRF-55681/Chips

Military Part Number Identification CDR33/34/35

CDR33/34/35 to MIL-PRF-55681/9/10/11

Military Type Designation ^{1/}	Capacitance in pF	Capacitance tolerance	Rated temperature and voltage-temperature limits	WVDC
AVX Style 1210/CDR33 (BP)				
CDR33BP102B---	1,000	F,J,K	BP	100
CDR33BP112B---	1,100	F,J,K	BP	100
CDR33BP122B---	1,200	F,J,K	BP	100
CDR33BP132B---	1,300	F,J,K	BP	100
CDR33BP152B---	1,500	F,J,K	BP	100
CDR33BP162B---	1,600	F,J,K	BP	100
CDR33BP182B---	1,800	F,J,K	BP	100
CDR33BP202B---	2,000	F,J,K	BP	100
CDR33BP222B---	2,200	F,J,K	BP	100
CDR33BP242A---	2,400	F,J,K	BP	50
CDR33BP272A---	2,700	F,J,K	BP	50
CDR33BP302A---	3,000	F,J,K	BP	50
CDR33BP332A---	3,300	F,J,K	BP	50
AVX Style 1210/CDR33 (BX)				
CDR33BX153B---	15,000	K,M	BX	100
CDR33BX183B---	18,000	K,M	BX	100
CDR33BX223B---	22,000	K,M	BX	100
CDR33BX273B---	27,000	K,M	BX	100
CDR33BX393A---	39,000	K,M	BX	50
CDR33BX473A---	47,000	K,M	BX	50
CDR33BX563A---	56,000	K,M	BX	50
CDR33BX683A---	68,000	K,M	BX	50
CDR33BX823A---	82,000	K,M	BX	50
CDR33BX104A---	100,000	K,M	BX	50
AVX Style 1812/CDR34 (BP)				
CDR34BP222B---	2,200	F,J,K	BP	100
CDR34BP242B---	2,400	F,J,K	BP	100
CDR34BP272B---	2,700	F,J,K	BP	100
CDR34BP302B---	3,000	F,J,K	BP	100
CDR34BP332B---	3,300	F,J,K	BP	100
CDR34BP362B---	3,600	F,J,K	BP	100
CDR34BP392B---	3,900	F,J,K	BP	100
CDR34BP432B---	4,300	F,J,K	BP	100
CDR34BP472B---	4,700	F,J,K	BP	100
CDR34BP512A---	5,100	F,J,K	BP	50
CDR34BP562A---	5,600	F,J,K	BP	50
CDR34BP622A---	6,200	F,J,K	BP	50
CDR34BP682A---	6,800	F,J,K	BP	50
CDR34BP752A---	7,500	F,J,K	BP	50
CDR34BP822A---	8,200	F,J,K	BP	50
CDR34BP912A---	9,100	F,J,K	BP	50
CDR34BP103A---	10,000	F,J,K	BP	50

- Add appropriate failure rate
- Add appropriate termination finish
- Capacitance Tolerance

Military Type Designation ^{1/}	Capacitance in pF	Capacitance tolerance	Rated temperature and voltage-temperature limits	WVDC
AVX Style 1812/CDR34 (BX)				
CDR34BX273B---	27,000	K,M	BX	100
CDR34BX333B---	33,000	K,M	BX	100
CDR34BX393B---	39,000	K,M	BX	100
CDR34BX473B---	47,000	K,M	BX	100
CDR34BX563B---	56,000	K,M	BX	100
CDR34BX104A---	100,000	K,M	BX	50
CDR34BX124A---	120,000	K,M	BX	50
CDR34BX154A---	150,000	K,M	BX	50
CDR34BX184A---	180,000	K,M	BX	50
AVX Style 1825/CDR35 (BP)				
CDR35BP472B---	4,700	F,J,K	BP	100
CDR35BP512B---	5,100	F,J,K	BP	100
CDR35BP562B---	5,600	F,J,K	BP	100
CDR35BP622B---	6,200	F,J,K	BP	100
CDR35BP682B---	6,800	F,J,K	BP	100
CDR35BP752B---	7,500	F,J,K	BP	100
CDR35BP822B---	8,200	F,J,K	BP	100
CDR35BP912B---	9,100	F,J,K	BP	100
CDR35BP103B---	10,000	F,J,K	BP	100
CDR35BP113A---	11,000	F,J,K	BP	50
CDR35BP123A---	12,000	F,J,K	BP	50
CDR35BP133A---	13,000	F,J,K	BP	50
CDR35BP153A---	15,000	F,J,K	BP	50
CDR35BP163A---	16,000	F,J,K	BP	50
CDR35BP183A---	18,000	F,J,K	BP	50
CDR35BP203A---	20,000	F,J,K	BP	50
CDR35BP223A---	22,000	F,J,K	BP	50
AVX Style 1825/CDR35 (BX)				
CDR35BX563B---	56,000	K,M	BX	100
CDR35BX683B---	68,000	K,M	BX	100
CDR35BX823B---	82,000	K,M	BX	100
CDR35BX104B---	100,000	K,M	BX	100
CDR35BX124B---	120,000	K,M	BX	100
CDR35BX154B---	150,000	K,M	BX	100
CDR35BX184A---	180,000	K,M	BX	50
CDR35BX224A---	220,000	K,M	BX	50
CDR35BX274A---	270,000	K,M	BX	50
CDR35BX334A---	330,000	K,M	BX	50
CDR35BX394A---	390,000	K,M	BX	50
CDR35BX474A---	470,000	K,M	BX	50

- Add appropriate failure rate
- Add appropriate termination finish
- Capacitance Tolerance

^{1/} The complete part number will include additional symbols to indicate capacitance tolerance, termination and failure rate level.

MQ Series – Medical Grade MLCC

General Specifications



GENERAL DESCRIPTION

AVX offers a wide variety of medically qualified passive components. Medical devices require the utmost reliability with respect to the components incorporated into the designs. Advanced design qualification requirements, in-process controls and requirements and lot acceptance testing are implemented to ensure these components will meet the superior reliability levels of a life supporting application. AVX medical MLCC reliability documents provide an advanced level of designing, manufacturing, testing and qualification that places AVX as the top supplier and industry leader of medically qualified MLCCs.

AVX MQ series of medically qualified ceramic capacitors are available in EIA case sizes ranging from 0402 to 2225, at typical voltage ratings between 4 – 200 Vdc with various termination options including Sn, SnPb solder, and Au.

APPLICATIONS

- Implantable cardioverter-defibrillator (ICD)
- Pacemakers
- Neuromodulation

FEATURES

- 0402 to 2225 case sizes
- Voltage range from 4v to 100v
- Capacitance up to 100 μ F
- Class I & II dielectric materials
- Tight tolerances on Class I dielectric materials
- Various terminations
- Customer specific requirements, screening, & testing

HOW TO ORDER

MQ02	Z	A	100	J	G	T	3	A
Size	Rated Voltage	Dielectric Code	Capacitance Code (In pF)	Capacitance Tolerance	Medical Grade	Termination Finish	Packaging	Special Code
MQ02 = 0402 MQ03 = 0603 MQ05 = 0805 MQ06 = 1206 MQ10 = 1210 MQ12 = 1812 MQ13 = 1825 MQ14 = 2225	4 = 4V 6 = 6.3V Z = 10V Y = 16V 3 = 25V 5 = 50V 1 = 100V	A = NP0 (C0G) C = X7R Z = X7S D = X5R	(2 significant digits + number of zeros) for values <10pF: letter R denotes decimal point. Example: 68pF = 680 8.2pF = 8R2	B = ± 0.1 pF C = ± 0.25 pF D = ± 0.5 pF F = $\pm 1\%$ (≥ 10 pF) G = $\pm 2\%$ (≥ 10 pF) J = $\pm 5\%$ K = $\pm 10\%$ M = $\pm 20\%$ N = $\pm 30\%$		T = Plated Ni & Sn J = 60/40 Sn/Pb B = 5% min Pb Plated Solder 7 = Gold Plated	1 = 7" Reel 2 = 7" Reel (0402 only) 3 = 13" Reel 4 = 13" Reel (0402 only) 6 = Waffle	A = Standard Contact AVX for others

MQ Series – Medical Grade MLCC

NP0 (C0G) – Capacitance & Voltage Range

PREFERRED SIZES ARE SHADED

SIZE	0402			0603				0805			1206				1210			1812			1825		2225						
Soldering	Reflow Only			Reflow/Wave				Reflow/Wave			Reflow/Wave				Reflow Only			Reflow Only			Reflow Only		Reflow Only						
Packaging	All Paper			All Embossed				All Embossed			All Embossed				All Embossed			All Embossed			All Embossed		All Embossed						
(L) Length	mm	1.00 ± 0.10 (0.040 ± 0.004)		1.60 ± 0.15 (0.063 ± 0.006)				2.01 ± 0.20 (0.079 ± 0.008)			3.20 ± 0.20 (0.126 ± 0.008)				3.20 ± 0.20 (0.126 ± 0.008)			4.50 ± 0.30 (0.177 ± 0.012)			4.50 ± 0.30 (0.177 ± 0.012)		5.72 ± 0.25 (0.225 ± 0.010)						
(W) Width	mm	0.50 ± 0.10 (0.020 ± 0.004)		0.81 ± 0.15 (0.032 ± 0.006)				1.25 ± 0.20 (0.049 ± 0.008)			1.60 ± 0.20 (0.063 ± 0.008)				2.50 ± 0.20 (0.098 ± 0.008)			3.20 ± 0.20 (0.126 ± 0.008)			6.40 ± 0.40 (0.252 ± 0.016)		6.35 ± 0.25 (0.250 ± 0.010)						
(t) Terminal	mm	0.25 ± 0.15 (0.010 ± 0.006)		0.35 ± 0.15 (0.037)				0.50 ± 0.25 (0.020 ± 0.010)			0.50 ± 0.25 (0.020 ± 0.010)				0.50 ± 0.25 (0.020 ± 0.010)			0.61 ± 0.36 (0.024 ± 0.014)			0.61 ± 0.36 (0.024 ± 0.014)		0.64 ± 0.39 (0.025 ± 0.015)						
Maximum Thickness	mm	0.56 (0.022)		0.94 (0.014 ± 0.006)				1.52 (0.060)			1.78 (0.070)				1.78 (0.070)			2.79 (0.110)			2.79 (0.110)		2.79 (0.110)						
WVDC		16	25	50	6.3	16	25	50	100	16	25	50	100	16	25	50	100	25	50	100	25	50	100	50	100	25	50	100	
Cap (pF)	0.5	Shaded																											
	1.0	Shaded																											
	1.2	Shaded																											
	1.5	Shaded																											
	1.8	Shaded																											
	2.2	Shaded																											
	2.7	Shaded																											
	3.3	Shaded																											
	3.9	Shaded																											
	4.7	Shaded																											
	5.6	Shaded																											
	6.8	Shaded																											
	8.2	Shaded																											
	10	Shaded																											
	12	Shaded																											
	15	Shaded																											
	18	Shaded																											
	22	Shaded																											
	27	Shaded																											
	33	Shaded																											
	39	Shaded																											
	47	Shaded																											
	56	Shaded																											
	68	Shaded																											
	82	Shaded																											
	100	Shaded																											
	120	Shaded																											
	150	Shaded																											
	180	Shaded																											
	220	Shaded																											
	270	Shaded																											
	330	Shaded																											
	390	Shaded																											
	470	Shaded																											
	560	Shaded																											
	680	Shaded																											
	820	Shaded																											
	1000	Shaded																											
	1200	Shaded																											
	1500	Shaded																											
	1800	Shaded																											
	2200	Shaded																											
	2700	Shaded																											
	3300	Shaded																											
	3900	Shaded																											
	4700	Shaded																											
	5600	Shaded																											
	6800	Shaded																											
	8200	Shaded																											
	10000	Shaded																											
WVDC		16	25	50	6.3	16	25	50	100	16	25	50	100	16	25	50	100	25	50	100	25	50	100	50	100	25	50	100	
SIZE		0402			0603				0805			1206				1210			1812			1825		2225					

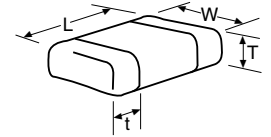

MQ Series – Medical Grade MLCC

NP0 (C0G) – General Specifications

TYPICAL ELECTRICAL CHARACTERISTICS

Temperature Coefficient

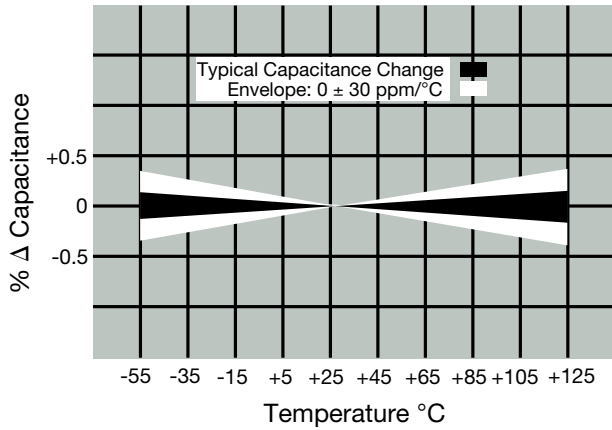

Δ Capacitance vs. Frequency

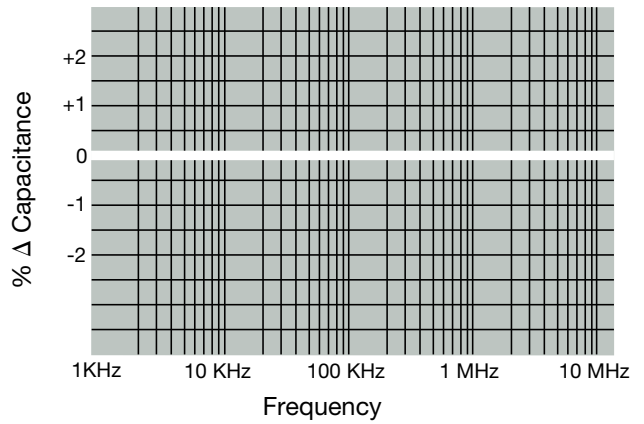

Insulation Resistance vs. Temperature

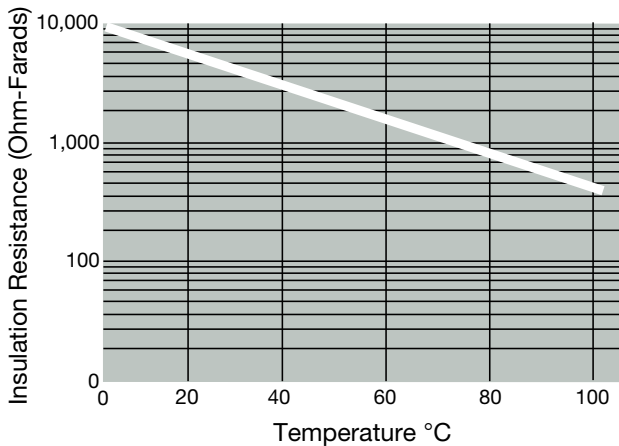

Variation of Impedance with Cap Value

Impedance vs. Frequency

0805 - C0G (NP0)

10 pF vs. 100 pF vs. 1000 pF

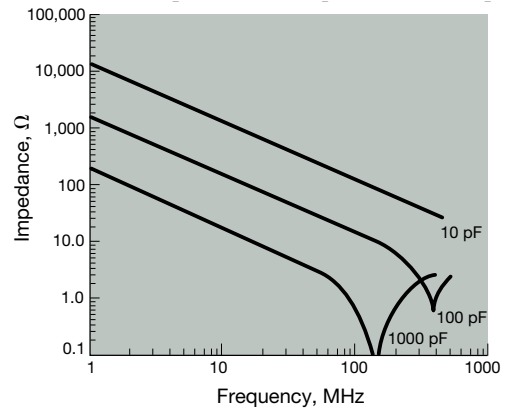

Variation of Impedance with Chip Size

Impedance vs. Frequency

1000 pF - C0G (NP0)

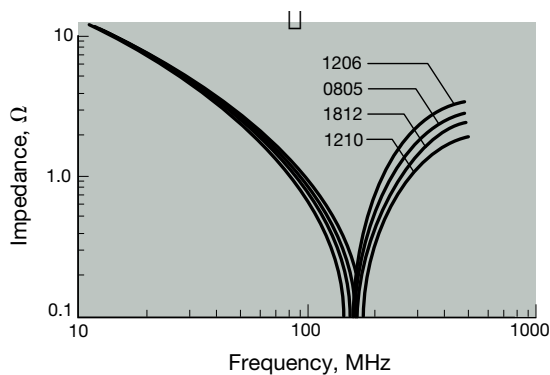

Variation of Impedance with Ceramic Formulation

Impedance vs. Frequency

1000 pF - C0G (NP0) vs. X7R

0805

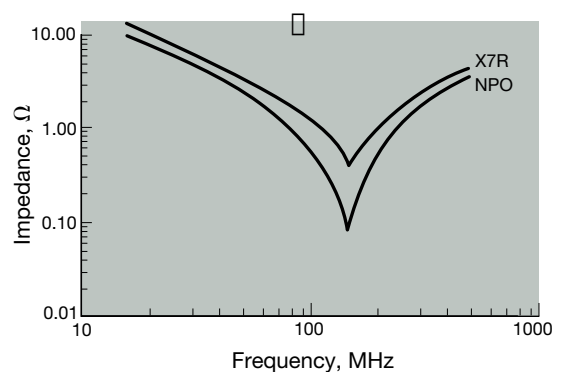

MQ Series – Medical Grade MLCC

NP0 (C0G) – Specifications & Test Methods

Parameter/Test		NP0 Specification Limits	Measuring Conditions	
Operating Temperature Range		-55°C to +125°C	Temperature Cycle Chamber	
Capacitance		Within specified tolerance	Freq.: 1.0 MHz ± 10% for cap ≤ 1000 pF 1.0 kHz ± 10% for cap > 1000 pF Voltage: 1.0Vrms ± .2V	
Q		<30 pF: Q ≥ 400+20 x Cap Value ≥30 pF: Q ≥ 1000	Charge device with rated voltage for 120 ± 5 secs @ room temp/humidity	
Insulation Resistance		100,000MΩ or 1000MΩ - μF, whichever is less	Charge device with 250% of rated voltage for 1-5 seconds, with charge and discharge current limited to 50 mA (max)	
Dielectric Strength		No breakdown or visual defects	Deflection: 2mm Test Time: 30 seconds	
Resistance to Flexure Stresses	Appearance	No defects		
	Capacitance Variation	±5% or ±.5 pF, whichever is greater		
	Q	Meets Initial Values (As Above)		
	Insulation Resistance	≥ Initial Value x 0.3		
Solderability		≥ 85% of each terminal should be covered with fresh solder	Dip device in eutectic solder at 245 ± 5°C for 5.0 ± 0.5 seconds	
Resistance to Solder Heat	Appearance	No defects, <25% leaching of either end terminal	MIL-STD-202 / Method 210 / Condition J (Reflow Mounting plus 1 Reflow Cycle @ 235°C ± 5°C)	
	Capacitance Variation	≤ ±2.5% or ±.25 pF, whichever is greater		
	Q	Meets Initial Values (As Above)		
	Insulation Resistance	Meets Initial Values (As Above)		
Thermal Shock	Appearance	No visual defects	Step 1: -55°C ± 2°	30 ± 3 minutes
	Capacitance Variation	≤ ±3.0% or ±0.3 pF, whichever is greater	Step 2: Room Temp	≤ 3 minutes
	Q	Meets Initial Values (As Above)	Step 3: +125°C ± 2°	30 ± 3 minutes
	Insulation Resistance	Meets Initial Values (As Above)	Step 4: Room Temp	≤ 3 minutes
	Dielectric Strength	Meets Initial Values (As Above)	Repeat for 5 cycles and measure after 24 hours at room temperature	
Load Life	Appearance	No visual defects	Load in test chamber set at 125°C ± 2°C for 1000 hours (+48, -0) with twice rated voltage applied. Remove from test chamber and stabilize at room temperature before measuring.	
	Capacitance Variation	≤ ±3.0% or ± 0.3 pF, whichever is greater		
	Q	≥ 30 pF: Q ≥ 350 ≥10 pF, <30 pF: Q ≥ 275 +5C/2 <10 pF: Q ≥ 200 +10C		
	Insulation Resistance	≥ Initial Value x 0.3 (See Above)		
	Dielectric Strength	Meets Initial Values (As Above)		
Load Humidity	Appearance	No visual defects	Load in a test chamber set at 85°C ± 2°C/85% ± 5% relative humidity for 1000 hours (+48, -0) with rated voltage applied. Remove from chamber and stabilize at room temperature before measuring.	
	Insulation Resistance	≥ Initial Value x 0.3 (See Above)		

MQ Series – Medical Grade MLCC

X7R/X7S – General Specifications

TYPICAL ELECTRICAL CHARACTERISTICS

X7R Dielectric
Typical Temperature Coefficient

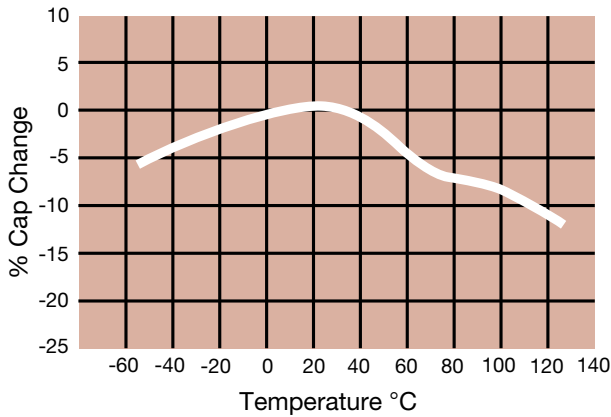

Δ Capacitance vs. Frequency

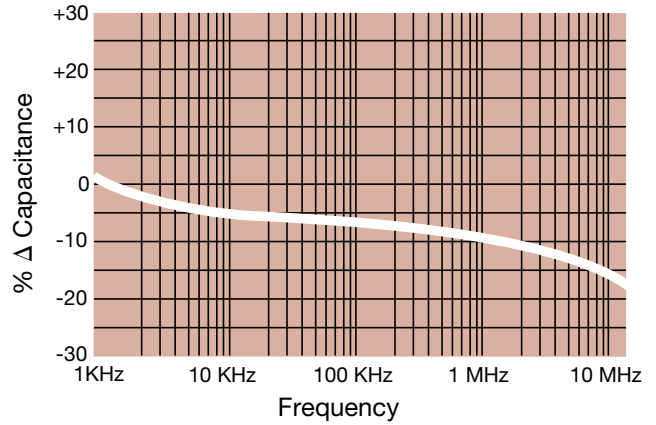

Insulation Resistance vs. Temperature

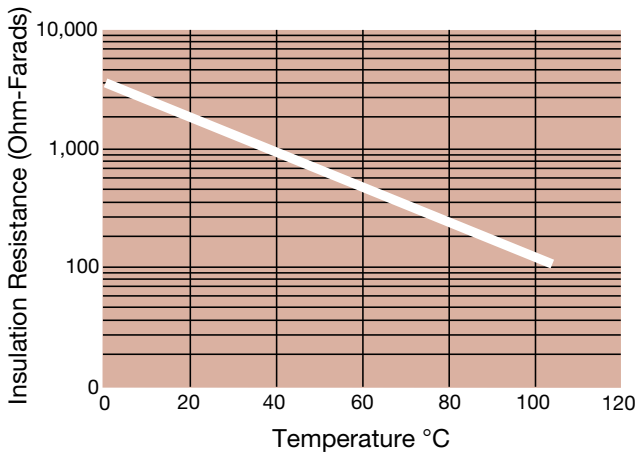

Variation of Impedance with Cap Value
Impedance vs. Frequency
1,000 pF vs. 10,000 pF - X7R
0805

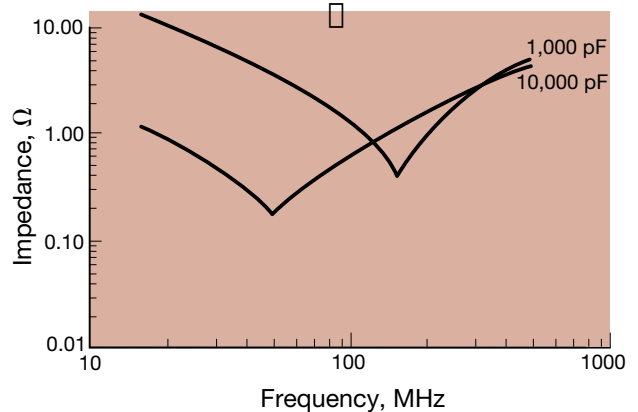

Variation of Impedance with Chip Size
Impedance vs. Frequency
10,000 pF - X7R

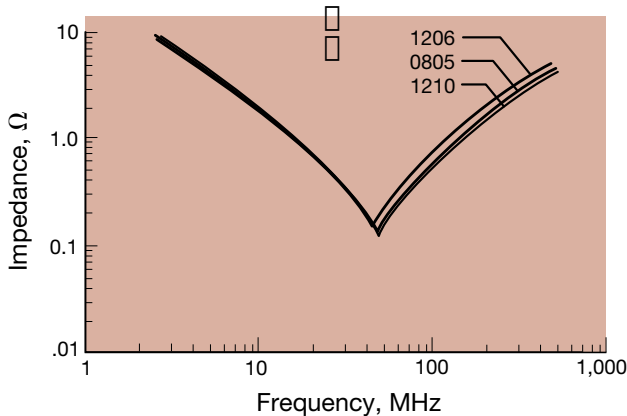

Variation of Impedance with Chip Size
Impedance vs. Frequency
100,000 pF - X7R

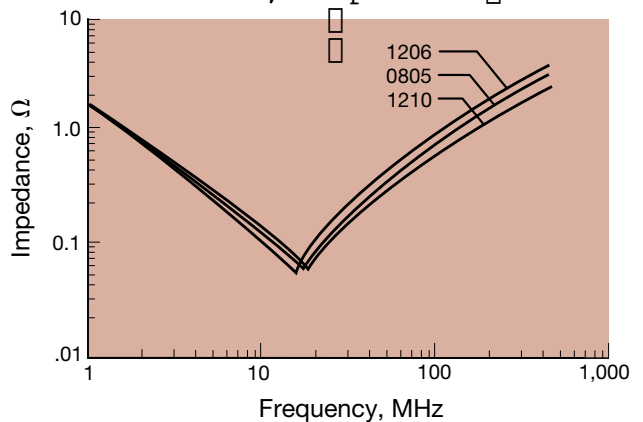

MQ Series – Medical Grade MLCC

X7R/X7S – Specifications & Test Methods

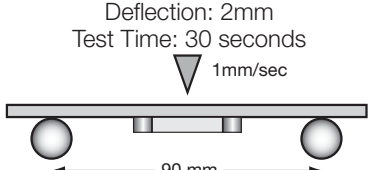
Parameter/Test		NPO Specification Limits	Measuring Conditions	
Operating Temperature Range		-55°C to +125°C	Temperature Cycle Chamber	
Capacitance		Within specified tolerance	Frequency: 1.0kHz ± 10% Voltage: 1.0Vrms ± 0.2V	
Dissipation Factor		≤ 2.5% for ≥ 50V DC rating ≤ 3.0% for 25V & 35V DC rating ≤ 12.5% for 16V DC rating and lower Contact factory for DF by PN		
Insulation Resistance		100,000MΩ or 1000MΩ - μF, whichever is less		
Dielectric Strength		No breakdown or visual defects	Charge device with 250% of rated voltage for 1-5 seconds, with charge and discharge current limited to 50 mA (max)	
Resistance to Flexure Stresses	Appearance	No defects	Deflection: 2mm Test Time: 30 seconds 	
	Capacitance Variation	≤ ±12%		
	Dissipation Factor	Meets Initial Values (As Above)		
	Insulation Resistance	≥ Initial Value x 0.3		
Solderability		≥ 85% of each terminal should be covered with fresh solder	Dip device in eutectic solder at 245 ± 5°C for 5.0 ± 0.5 seconds	
Resistance to Solder Heat	Appearance	No defects, <25% leaching of either end terminal	MIL-STD-202 / Method 210 / Condition J (Reflow Mounting plus 1 Reflow Cycle @ 235°C ± 5°C)	
	Capacitance Variation	≤ ±7.5%		
	Dissipation Factor	Meets Initial Values (As Above)		
	Insulation Resistance	Meets Initial Values (As Above)		
Thermal Shock	Appearance	No visual defects	Step 1: -55°C ± 2°	30 ± 3 minutes
	Capacitance Variation	≤ ±7.5%	Step 2: Room Temp	≤ 3 minutes
	Dissipation Factor	Meets Initial Values (As Above)	Step 3: +125°C ± 2°	30 ± 3 minutes
	Insulation Resistance	Meets Initial Values (As Above)	Step 4: Room Temp	≤ 3 minutes
	Dielectric Strength	Meets Initial Values (As Above)	Repeat for 5 cycles and measure after 24 hours at room temperature	
Load Life	Appearance	No visual defects	Load in test chamber set at 125°C ± 2°C for 1000 hours (+48, -0) with twice rated voltage applied. Remove from test chamber and stabilize at room temperature before measuring.	
	Capacitance Variation	≤ ±12.5%		
	Dissipation Factor	≤ initial value x 2.0 (see above)		
	Insulation Resistance	≥ Initial Value x 0.3 (See Above)		
	Dielectric Strength	Meets Initial Values (As Above)		
Load Humidity	Appearance	No visual defects	Load in a test chamber set at 85°C ± 2°C/85% ± 5% relative humidity for 1000 hours (+48, -0) with rated voltage applied. Remove from chamber and stabilize at room temperature before measuring.	
	Insulation Resistance	≥ Initial Value x 0.3 (See Above)		

MQ Series – Medical Grade MLCC

X5R – Capacitance & Voltage Range

PREFERRED SIZES ARE SHADED

SIZE	0402					0603					0805					1206					1210					1812																																																																															
Soldering	Reflow Only					Reflow/Wave					Reflow/Wave					Reflow/Wave					Reflow Only					Reflow Only																																																																															
Packaging	All Paper					All Embossed					All Embossed					All Embossed					All Embossed					All Embossed																																																																															
(L) Length (mm)	1.00 ± 0.10 (0.040 ± 0.004)					1.60 ± 0.15 (0.063 ± 0.006)					2.01 ± 0.20 (0.079 ± 0.008)					3.20 ± 0.20 (0.126 ± 0.008)					3.20 ± 0.20 (0.126 ± 0.008)					4.50 ± 0.30 (0.177 ± 0.012)																																																																															
(W) Width (mm)	0.50 ± 0.10 (0.020 ± 0.004)					0.81 ± 0.15 (0.032 ± 0.006)					1.25 ± 0.20 (0.049 ± 0.008)					1.60 ± 0.20 (0.063 ± 0.008)					2.50 ± 0.20 (0.098 ± 0.008)					3.20 ± 0.20 (0.126 ± 0.008)																																																																															
(t) Terminal (mm)	0.25 ± 0.15 (0.010 ± 0.006)					0.35 ± 0.15 (0.037)					0.50 ± 0.25 (0.020 ± 0.010)					0.50 ± 0.25 (0.020 ± 0.010)					0.50 ± 0.25 (0.020 ± 0.010)					0.61 ± 0.36 (0.024 ± 0.014)																																																																															
Maximum Thickness (mm)	0.56 (0.022)					0.94 (0.014 ± 0.006)					1.52 (0.060)					1.78 (0.070)					1.78 (0.070)					2.79 (0.110)																																																																															
WVDC	4	6.3	10	16	25	50	4	6.3	10	16	25	50	6.3	10	16	25	50	6.3	10	16	25	50	4	6.3	10	16	25	50	6.3	10	25	50																																																																									
Cap (µF)	0.01					0.015					0.022					0.033					0.047					0.068					0.1					0.15					0.22					0.33					0.47					0.68					1.0					1.5					2.2					3.3					4.7					10					22					47					100				
WVDC	4	6.3	10	16	25	50	4	6.3	10	16	25	50	6.3	10	16	25	50	6.3	10	16	25	50	4	6.3	10	16	25	50	6.3	10	25	50																																																																									
SIZE	0402					0603					0805					1206					1210					1812																																																																															

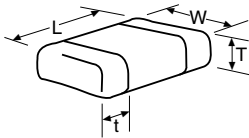

TYPICAL ELECTRICAL CHARACTERISTICS

Temperature Coefficient

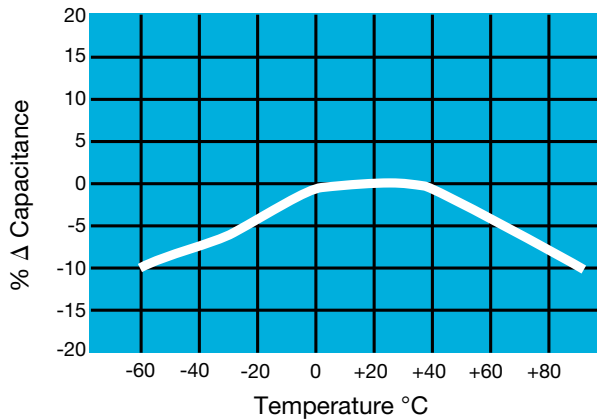

Insulation Resistance vs. Temperature

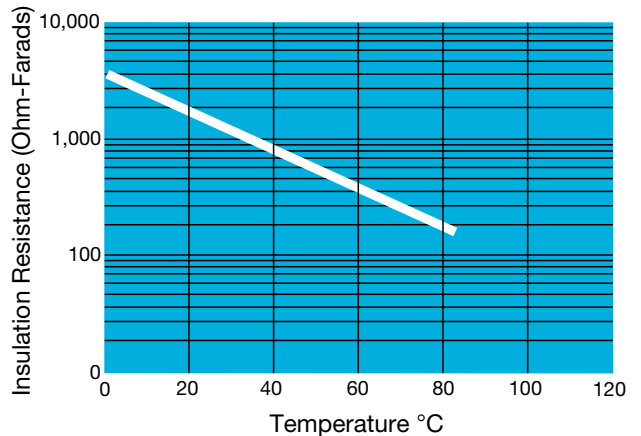

MQ Series – Medical Grade MLCC

X5R – Specifications & Test Methods

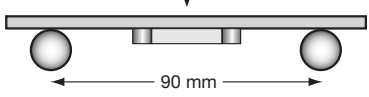
Parameter/Test		X5R Specification Limits	Measuring Conditions	
Operating Temperature Range		-55°C to +85°C	Temperature Cycle Chamber	
Capacitance		Within specified tolerance	Freq.: 1.0 kHz ± 10% Voltage: 1.0Vrms ± .2V For Cap > 10 µF, 0.5Vrms @ 120Hz	
Dissipation Factor		≤ 2.5% for ≥ 50V DC rating ≤ 3.0% for 25V, 35V DC rating ≤ 12.5% Max. for 16V DC rating and lower Contact Factory for DF by PN		
Insulation Resistance		10,000MΩ or 500MΩ - µF, whichever is less	Charge device with rated voltage for 120 ± 5 secs @ room temp/humidity	
Dielectric Strength		No breakdown or visual defects	Charge device with 150% of rated voltage for 1-5 seconds, w/charge and discharge current limited to 50 mA (max)	
Resistance to Flexure Stresses	Appearance	No defects	Deflection: 2mm Test Time: 30 seconds 	
	Capacitance Variation	≤ ±12%		
	Dissipation Factor	Meets Initial Values (As Above)		
	Insulation Resistance	≥ Initial Value x 0.3		
Solderability		≥ 85% of each terminal should be covered with fresh solder	Dip device in eutectic solder at 245 ± 5°C for 5.0 ± 0.5 seconds	
Resistance to Solder Heat	Appearance	No defects, <25% leaching of either end terminal	MIL-STD-202 / Method 210 / Condition J (Reflow Mounting plus 1 Reflow Cycle @ 235°C ± 5°C)	
	Capacitance Variation	≤ ±7.5%		
	Dissipation Factor	Meets Initial Values (As Above)		
	Insulation Resistance	Meets Initial Values (As Above)		
Thermal Shock	Appearance	No visual defects	Step 1: -55°C ± 2°	30 ± 3 minutes
	Capacitance Variation	≤ ±7.5%	Step 2: Room Temp	≤ 3 minutes
	Dissipation Factor	Meets Initial Values (As Above)	Step 3: +85°C ± 2°	30 ± 3 minutes
	Insulation Resistance	Meets Initial Values (As Above)	Step 4: Room Temp	≤ 3 minutes
	Dielectric Strength	Meets Initial Values (As Above)	Repeat for 5 cycles and measure after 24 ± 2 hours at room temperature	
Load Life	Appearance	No visual defects	Load in test chamber set at 85°C ± 2°C for 1000 hours (+48, -0) with twice rated voltage applied. Remove from test chamber and stabilize at room temperature before measuring.	
	Capacitance Variation	≤ ±12.5%		
	Dissipation Factor	≤ Initial Value x 2.0 (See Above)		
	Insulation Resistance	≥ Initial Value x 0.3 (See Above)		
	Dielectric Strength	Meets Initial Values (As Above)		
Load Humidity	Appearance	No visual defects	Load in a test chamber set at 85°C ± 2°C/85% ± 5% relative humidity for 1000 hours (+48, -0) with rated voltage applied. Remove from chamber and stabilize at room temperature before measuring.	
	Insulation Resistance	≥ Initial Value x 0.3 (See Above)		

Packaging of Chip Components

Automatic Insertion Packaging

TAPE & REEL QUANTITIES

All tape and reel specifications are in compliance with RS481.

	4mm	8mm	12mm	
Paper or Embossed Carrier		0612, 0508, 0805, 1206, 1210		
Embossed Only	0101		1808	1812, 1825 2220, 2225
Paper Only		0101, 0201, 0306, 0402, 0603		
Qty. per Reel/7" Reel	4,000	1,000, 2,000, 3,000 or 4,000, 10,000, 15,000, 20,000 Contact factory for exact quantity	3,000	500, 1,000 Contact factory for exact quantity
Qty. per Reel/13" Reel		5,000, 10,000, 50,000 Contact factory for exact quantity	10,000	4,000

REEL DIMENSIONS

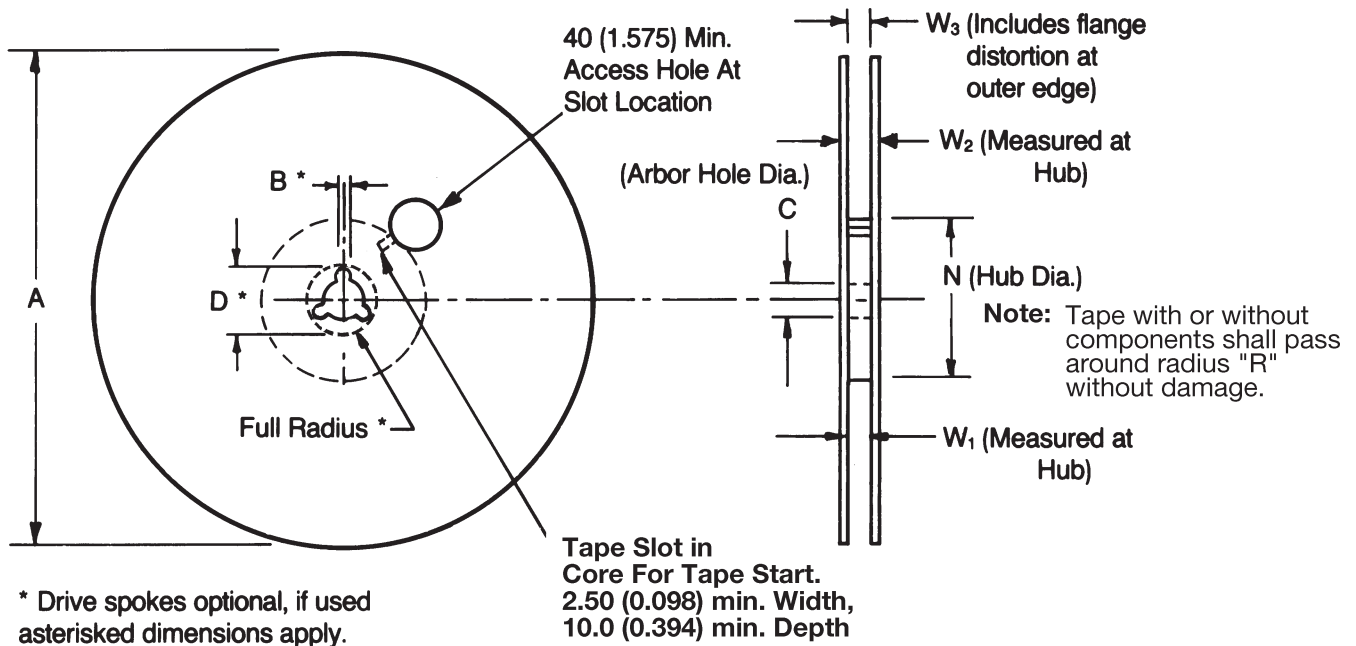

Tape Size ⁽¹⁾	A Max.	B* Min.	C	D* Min.	N Min.	W ₁	W ₂ Max.	W ₃
4mm	1.80 (7.087)	1.5 (0.059)	13.0±0.5 (0.522±0.020)	20.2 (0.795)	60.0 (2.362)	4.35±0.3 (0.171±0.011)	7.95 (0.312)	
8mm						8.40 ^{+1.5} _{-0.0} (0.331 ^{+0.059} _{-0.0})	14.4 (0.567)	7.90 Min. (0.311) 10.9 Max. (0.429)
12mm	330 (12.992)	1.5 (0.059)	13.0 ^{+0.50} _{-0.20} (0.512 ^{+0.020} _{-0.008})	20.2 (0.795)	50.0 (1.969)	12.4 ^{+2.0} _{-0.0} (0.488 ^{+0.079} _{-0.0})	18.4 (0.724)	11.9 Min. (0.469) 15.4 Max. (0.607)

Metric dimensions will govern.

English measurements rounded and for reference only.

(1) For tape sizes 16mm and 24mm (used with chip size 3640) consult EIA RS-481 latest revision.

Embossed Carrier Configuration

4, 8 & 12mm Tape Only

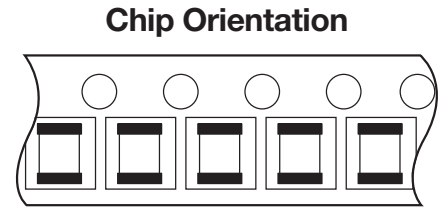
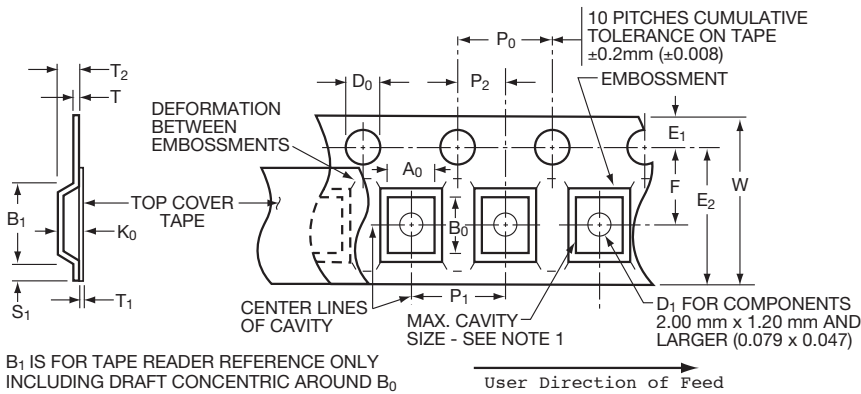

4, 8 & 12mm Embossed Tape Metric Dimensions Will Govern

CONSTANT DIMENSIONS

Tape Size	D ₀	E ₁	P ₀	P ₂	S ₁ Min.	T Max.	T ₁ Max.
4mm	0.80±0.04 (0.031±0.001)	0.90±0.05 (0.035±0.001)	2.0±0.04 (0.078±0.001)	1.00±0.02 (0.039±0.0007)	1.075 (0.042)	0.26 (0.010)	0.06 (0.002)
8mm & 12mm	1.50 ^{+0.10} _{-0.0} (0.059 ^{+0.004} _{-0.0})	1.75 ± 0.10 (0.069 ± 0.004)	4.0 ± 0.10 (0.157 ± 0.004)	2.0 ± 0.05 (0.079 ± 0.002)	0.60 (0.024)	0.60 (0.024)	0.10 (0.004)

VARIABLE DIMENSIONS

Tape Size	B ₁ Max.	D ₁ Min.	E ₂ Min.	F	P ₁ See Note 5	R Min. See Note 2	T ₂	W Max.	A ₀ B ₀ K ₀
8mm	4.35 (0.171)	1.00 (0.039)	6.25 (0.246)	3.50 ± 0.05 (0.138 ± 0.002)	4.00 ± 0.10 (0.157 ± 0.004)	25.0 (0.984)	2.50 Max. (0.098)	8.30 (0.327)	See Note 1
12mm	8.20 (0.323)	1.50 (0.059)	10.25 (0.404)	5.50 ± 0.05 (0.217 ± 0.002)	4.00 ± 0.10 (0.157 ± 0.004)	30.0 (1.181)	6.50 Max. (0.256)	12.3 (0.484)	See Note 1
8mm 1/2 Pitch	4.35 (0.171)	1.00 (0.039)	6.25 (0.246)	3.50 ± 0.05 (0.138 ± 0.002)	2.00 ± 0.10 (0.079 ± 0.004)	25.0 (0.984)	2.50 Max. (0.098)	8.30 (0.327)	See Note 1
12mm Double Pitch	8.20 (0.323)	1.50 (0.059)	10.25 (0.404)	5.50 ± 0.05 (0.217 ± 0.002)	8.00 ± 0.10 (0.315 ± 0.004)	30.0 (1.181)	6.50 Max. (0.256)	12.3 (0.484)	See Note 1

NOTES:

1. The cavity defined by A₀, B₀, and K₀ shall be configured to provide the following:

Surround the component with sufficient clearance such that:

- the component does not protrude beyond the sealing plane of the cover tape.
- the component can be removed from the cavity in a vertical direction without mechanical restriction, after the cover tape has been removed.
- rotation of the component is limited to 20° maximum (see Sketches D & E).
- lateral movement of the component is restricted to 0.5mm maximum (see Sketch F).

2. Tape with or without components shall pass around radius "R" without damage.

3. Bar code labeling (if required) shall be on the side of the reel opposite the round sprocket holes. Refer to EIA-556.

4. B₀ dimension is a reference dimension for tape feeder clearance only.

5. If P₁ = 2.0mm, the tape may not properly index in all tape feeders.

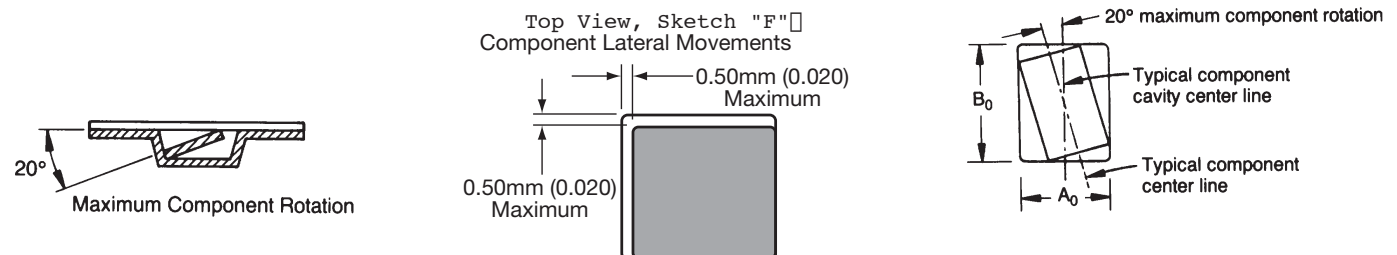

Paper Carrier Configuration

8 & 12mm Tape Only

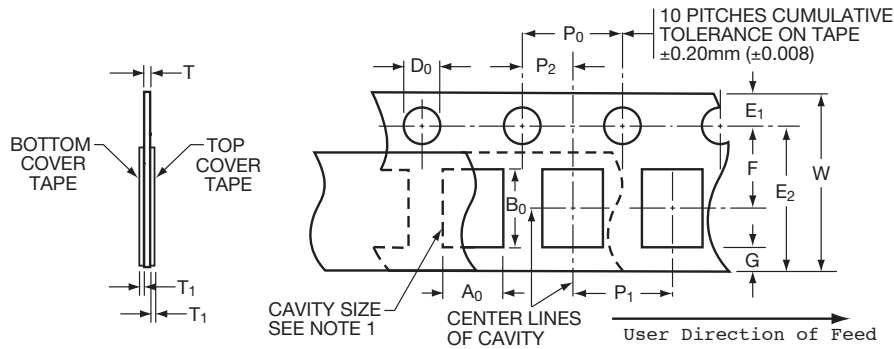

8 & 12mm Paper Tape Metric Dimensions Will Govern

CONSTANT DIMENSIONS

Tape Size	D_0	E	P_0	P_2	T_1	G. Min.	R Min.
8mm and 12mm	$1.50^{+0.10}_{-0.004}$ (0.059 \pm 0.004)	1.75 ± 0.10 (0.069 \pm 0.004)	4.00 ± 0.10 (0.157 \pm 0.004)	2.00 ± 0.05 (0.079 \pm 0.002)	0.10 (0.004) Max.	0.75 (0.030) Min.	25.0 (0.984) See Note 2 Min.

VARIABLE DIMENSIONS

Tape Size	P_1 See Note 4	E_2 Min.	F	W	$A_0 B_0$	T
8mm	4.00 ± 0.10 (0.157 \pm 0.004)	6.25 (0.246)	3.50 ± 0.05 (0.138 \pm 0.002)	$8.00^{+0.30}_{-0.10}$ (0.315 \pm 0.012)	See Note 1	1.10mm (0.043) Max. for Paper Base Tape and 1.60mm (0.063) Max. for Non-Paper Base Compositions
12mm	4.00 ± 0.10 (0.157 \pm 0.004)	10.25 (0.404)	5.50 ± 0.05 (0.217 \pm 0.002)	12.0 ± 0.30 (0.472 \pm 0.012)		
8mm 1/2 Pitch	2.00 ± 0.05 (0.079 \pm 0.002)	6.25 (0.246)	3.50 ± 0.05 (0.138 \pm 0.002)	$8.00^{+0.30}_{-0.10}$ (0.315 \pm 0.012)		
12mm Double Pitch	8.00 ± 0.10 (0.315 \pm 0.004)	10.25 (0.404)	5.50 ± 0.05 (0.217 \pm 0.002)	12.0 ± 0.30 (0.472 \pm 0.012)		

NOTES:

- The cavity defined by A_0 , B_0 , and T shall be configured to provide sufficient clearance surrounding the component so that:
 - the component does not protrude beyond either surface of the carrier tape;
 - the component can be removed from the cavity in a vertical direction without mechanical restriction after the top cover tape has been removed;
 - rotation of the component is limited to 20° maximum (see Sketches A & B);
 - lateral movement of the component is restricted to 0.5mm maximum (see Sketch C).
- Tape with or without components shall pass around radius "R" without damage.
- Bar code labeling (if required) shall be on the side of the reel opposite the sprocket holes. Refer to EIA-556.
- If $P_1 = 2.0\text{mm}$, the tape may not properly index in all tape feeders.

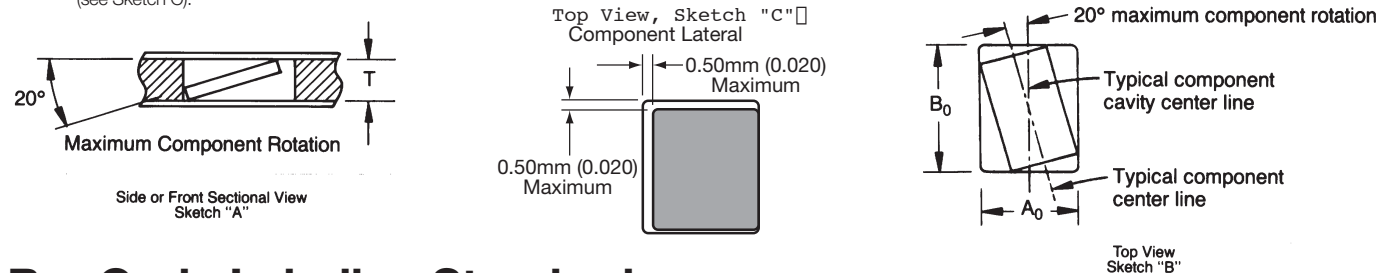

Bar Code Labeling Standard

AVX bar code labeling is available and follows latest version of EIA-556

Basic Capacitor Formulas

I. Capacitance (farads)

$$\text{English: } C = \frac{.224 \text{ K A}}{T_D}$$

$$\text{Metric: } C = \frac{.0884 \text{ K A}}{T_D}$$

II. Energy stored in capacitors (Joules, watt - sec)

$$E = \frac{1}{2} CV^2$$

III. Linear charge of a capacitor (Amperes)

$$I = C \frac{dV}{dt}$$

IV. Total Impedance of a capacitor (ohms)

$$Z = \sqrt{R_S^2 + (X_C - X_L)^2}$$

V. Capacitive Reactance (ohms)

$$X_C = \frac{1}{2 \pi fC}$$

VI. Inductive Reactance (ohms)

$$X_L = 2 \pi fL$$

VII. Phase Angles:

Ideal Capacitors: Current leads voltage 90°

Ideal Inductors: Current lags voltage 90°

Ideal Resistors: Current in phase with voltage

VIII. Dissipation Factor (%)

$$\text{D.F.} = \tan \delta \text{ (loss angle)} = \frac{\text{E.S.R.}}{X_C} = (2 \pi fC) (\text{E.S.R.})$$

IX. Power Factor (%)

P.F. = Sine δ (loss angle) = Cos ϕ (phase angle)

P.F. = (when less than 10%) = DF

X. Quality Factor (dimensionless)

$$Q = \text{Cotan } \delta \text{ (loss angle)} = \frac{1}{\text{D.F.}}$$

XI. Equivalent Series Resistance (ohms)

$$\text{E.S.R.} = (\text{D.F.}) (X_C) = (\text{D.F.}) / (2 \pi fC)$$

XII. Power Loss (watts)

$$\text{Power Loss} = (2 \pi fCV^2) (\text{D.F.})$$

XIII. KVA (Kilowatts)

$$\text{KVA} = 2 \pi fCV^2 \times 10^{-3}$$

XIV. Temperature Characteristic (ppm/°C)

$$\text{T.C.} = \frac{C_t - C_{25}}{C_{25} (T_t - 25)} \times 10^6$$

XV. Cap Drift (%)

$$\text{C.D.} = \frac{C_1 - C_2}{C_1} \times 100$$

XVI. Reliability of Ceramic Capacitors

$$L_t = \left(\frac{V_t}{V_o} \right)^X \left(\frac{T_t}{T_o} \right)^Y$$

XVII. Capacitors in Series (current the same)

$$\text{Any Number: } \frac{1}{C_T} = \frac{1}{C_1} + \frac{1}{C_2} \dots \frac{1}{C_N}$$

$$\text{Two: } C_T = \frac{C_1 C_2}{C_1 + C_2}$$

XVIII. Capacitors in Parallel (voltage the same)

$$C_T = C_1 + C_2 \dots + C_N$$

XIX. Aging Rate

$$\text{A.R.} = \% \Delta C / \text{decade of time}$$

XX. Decibels

$$\text{db} = 20 \log \frac{V_1}{V_2}$$

METRIC PREFIXES

Pico	X 10 ⁻¹²
Nano	X 10 ⁻⁹
Micro	X 10 ⁻⁶
Milli	X 10 ⁻³
Deci	X 10 ⁻¹
Deca	X 10 ⁺¹
Kilo	X 10 ⁺³
Mega	X 10 ⁺⁶
Giga	X 10 ⁺⁹
Tera	X 10 ⁺¹²

SYMBOLS

K = Dielectric Constant	f = frequency	L _t = Test life
A = Area	L = Inductance	V _t = Test voltage
T _D = Dielectric thickness	δ = Loss angle	V _O = Operating voltage
V = Voltage	ϕ = Phase angle	T _t = Test temperature
t = time	X & Y = exponent effect of voltage and temp.	T _O = Operating temperature
R _S = Series Resistance	L _O = Operating life	

General Description

Basic Construction – A multilayer ceramic (MLC) capacitor is a monolithic block of ceramic containing two sets of offset, interleaved planar electrodes that extend to two opposite surfaces of the ceramic dielectric. This simple

structure requires a considerable amount of sophistication, both in material and manufacture, to produce it in the quality and quantities needed in today's electronic equipment.

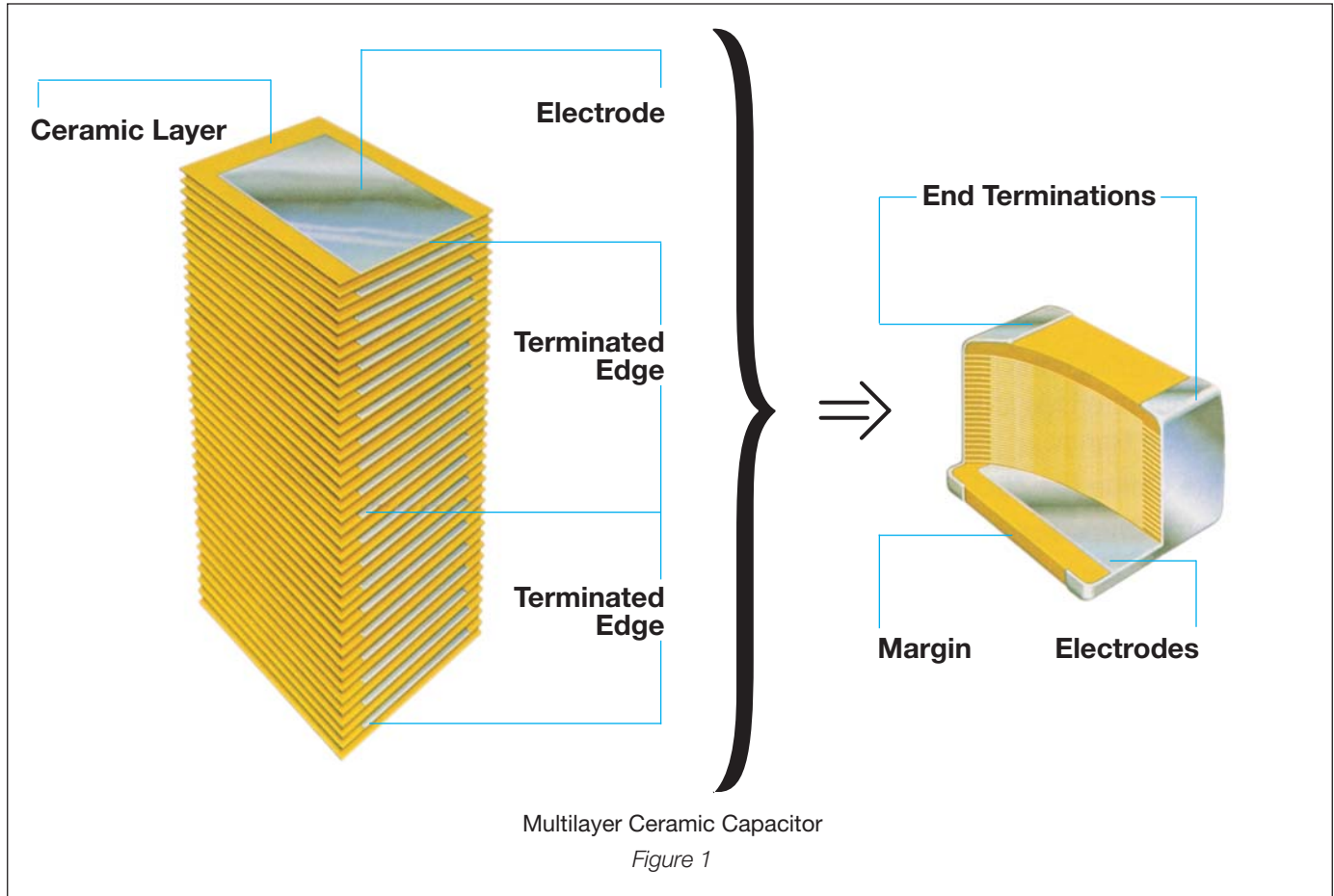

Formulations – Multilayer ceramic capacitors are available in both Class 1 and Class 2 formulations. Temperature compensating formulations are Class 1 and temperature stable and general application formulations are classified as Class 2.

Class 1 – Class 1 capacitors or temperature compensating capacitors are usually made from mixtures of titanates where barium titanate is normally not a major part of the mix. They have predictable temperature coefficients and in general, do not have an aging characteristic. Thus they are the most stable capacitor available. The most popular Class 1 multilayer ceramic capacitors are C0G (NP0) temperature compensating capacitors (negative-positive 0 ppm/°C).

Class 2 – EIA Class 2 capacitors typically are based on the chemistry of barium titanate and provide a wide range of capacitance values and temperature stability. The most commonly used Class 2 dielectrics are X7R and Y5V. The X7R provides intermediate capacitance values which vary only $\pm 15\%$ over the temperature range of -55°C to 125°C . It finds applications where stability over a wide temperature range is required.

The Y5V provides the highest capacitance values and is used in applications where limited temperature changes are expected. The capacitance value for Y5V can vary from 22% to -82% over the -30°C to 85°C temperature range.

All Class 2 capacitors vary in capacitance value under the influence of temperature, operating voltage (both AC and DC), and frequency. For additional information on performance changes with operating conditions, consult AVX's software, SpiCap.

General Description

Table 1: EIA and MIL Temperature Stable and General Application Codes

EIA CODE	
Percent Capacity Change Over Temperature Range	
RS198	Temperature Range
X7	-55°C to +125°C
X6	-55°C to +105°C
X5	-55°C to +85°C
Y5	-30°C to +85°C
Z5	+10°C to +85°C
Code	Percent Capacity Change
D	±3.3%
E	±4.7%
F	±7.5%
P	±10%
R	±15%
S	±22%
T	+22%, -33%
U	+22%, -56%
V	+22%, -82%

EXAMPLE – A capacitor is desired with the capacitance value at 25°C to increase no more than 7.5% or decrease no more than 7.5% from -30°C to +85°C. EIA Code will be Y5F.

MIL CODE		
Symbol	Temperature Range	
A	-55°C to +85°C	
B	-55°C to +125°C	
C	-55°C to +150°C	
Symbol	Cap. Change Zero Volts	Cap. Change Rated Volts
R	+15%, -15%	+15%, -40%
S	+22%, -22%	+22%, -56%
W	+22%, -56%	+22%, -66%
X	+15%, -15%	+15%, -25%
Y	+30%, -70%	+30%, -80%
Z	+20%, -20%	+20%, -30%

Temperature characteristic is specified by combining range and change symbols, for example BR or AW. Specification slash sheets indicate the characteristic applicable to a given style of capacitor.

In specifying capacitance change with temperature for Class 2 materials, EIA expresses the capacitance change over an operating temperature range by a 3 symbol code. The first symbol represents the cold temperature end of the temperature range, the second represents the upper limit of the operating temperature range and the third symbol represents the capacitance change allowed over the operating temperature range. Table 1 provides a detailed explanation of the EIA system.

Effects of Voltage – Variations in voltage have little effect on Class 1 dielectric but does affect the capacitance and dissipation factor of Class 2 dielectrics. The application of DC voltage reduces both the capacitance and dissipation factor while the application of an AC voltage within a reasonable range tends to increase both capacitance and dissipation factor readings. If a high enough AC voltage is applied, eventually it will reduce capacitance just as a DC voltage will. Figure 2 shows the effects of AC voltage.

**Cap. Change vs. A.C. Volts
X7R**

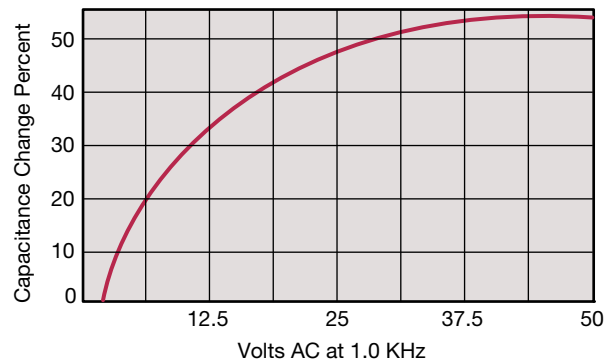

Figure 2

Capacitor specifications specify the AC voltage at which to measure (normally 0.5 or 1 VAC) and application of the wrong voltage can cause spurious readings. Figure 3 gives the voltage coefficient of dissipation factor for various AC voltages at 1 kilohertz. Applications of different frequencies will affect the percentage changes versus voltages.

**D.F. vs. A.C. Measurement Volts
X7R**

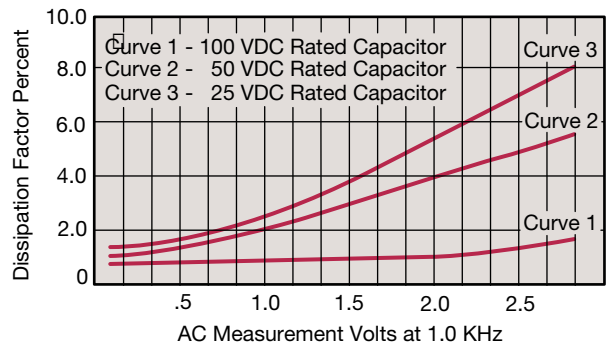

Figure 3

Typical effect of the application of DC voltage is shown in Figure 4. The voltage coefficient is more pronounced for higher K dielectrics. These figures are shown for room temperature conditions. The combination characteristic known as voltage temperature limits which shows the effects of rated voltage over the operating temperature range is shown in Figure 5 for the military BX characteristic.

General Description

**Typical Cap. Change vs. D.C. Volts
X7R**

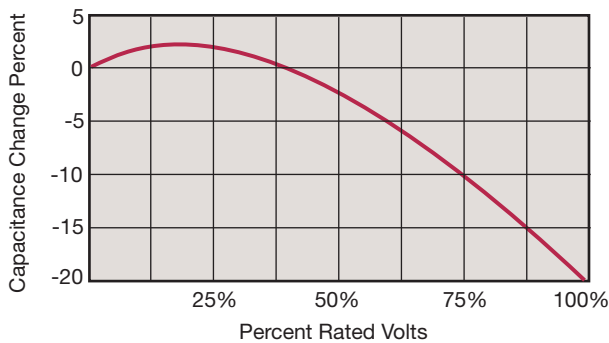

Figure 4

**Typical Cap. Change vs. Temperature
X7R**

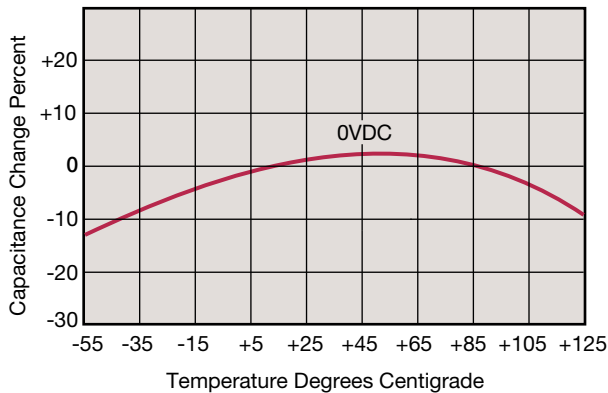

Figure 5

Effects of Time – Class 2 ceramic capacitors change capacitance and dissipation factor with time as well as temperature, voltage and frequency. This change with time is known as aging. Aging is caused by a gradual re-alignment of the crystalline structure of the ceramic and produces an exponential loss in capacitance and decrease in dissipation factor versus time. A typical curve of aging rate for semistable ceramics is shown in Figure 6.

If a Class 2 ceramic capacitor that has been sitting on the shelf for a period of time, is heated above its curie point, (125°C for 4 hours or 150°C for ½ hour will suffice) the part will de-age and return to its initial capacitance and dissipation factor readings. Because the capacitance changes rapidly, immediately after de-aging, the basic capacitance measurements are normally referred to a time period sometime after the de-aging process. Various manufacturers use different time bases but the most popular one is one day or twenty-four hours after “last heat.” Change in the aging curve can be caused by the application of voltage and other stresses. The possible changes in capacitance due to de-aging by heating the unit explain why capacitance changes are allowed after test, such as temperature cycling, moisture resistance, etc., in MIL specs. The application of high voltages such as dielectric withstanding voltages also tends to de-age

capacitors and is why re-reading of capacitance after 12 or 24 hours is allowed in military specifications after dielectric strength tests have been performed.

**Typical Curve of Aging Rate
X7R**

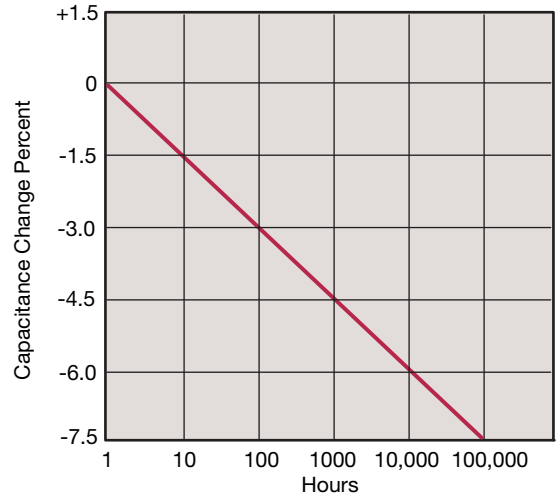

Characteristic	Max. Aging Rate %/Decade
C0G (NP0)	None
X7R, X5R	2
Y5V	7

Figure 6

Effects of Frequency – Frequency affects capacitance and impedance characteristics of capacitors. This effect is much more pronounced in high dielectric constant ceramic formulation than in low K formulations. AVX’s SpiCap software generates impedance, ESR, series inductance, series resonant frequency and capacitance all as functions of frequency, temperature and DC bias for standard chip sizes and styles. It is available free from AVX and can be downloaded for free from AVX website: www.avx.com.



General Description

Effects of Mechanical Stress – High “K” dielectric ceramic capacitors exhibit some low level piezoelectric reactions under mechanical stress. As a general statement, the piezoelectric output is higher, the higher the dielectric constant of the ceramic. It is desirable to investigate this effect before using high “K” dielectrics as coupling capacitors in extremely low level applications.

Reliability – Historically ceramic capacitors have been one of the most reliable types of capacitors in use today. The approximate formula for the reliability of a ceramic capacitor is:

$$\frac{L_o}{L_t} = \left(\frac{V_t}{V_o}\right)^X \left(\frac{T_t}{T_o}\right)^Y$$

where

L_o = operating life T_t = test temperature and
 L_t = test life T_o = operating temperature
 V_t = test voltage in °C
 V_o = operating voltage X, Y = see text

Historically for ceramic capacitors exponent X has been considered as 3. The exponent Y for temperature effects typically tends to run about 8.

A capacitor is a component which is capable of storing electrical energy. It consists of two conductive plates (electrodes) separated by insulating material which is called the dielectric. A typical formula for determining capacitance is:

$$C = \frac{.224 KA}{t}$$

C = capacitance (picofarads)
 K = dielectric constant (Vacuum = 1)
 A = area in square inches
 t = separation between the plates in inches
 (thickness of dielectric)
 $.224$ = conversion constant
 (.0884 for metric system in cm)

Capacitance – The standard unit of capacitance is the farad. A capacitor has a capacitance of 1 farad when 1 coulomb charges it to 1 volt. One farad is a very large unit and most capacitors have values in the micro (10^{-6}), nano (10^{-9}) or pico (10^{-12}) farad level.

Dielectric Constant – In the formula for capacitance given above the dielectric constant of a vacuum is arbitrarily chosen as the number 1. Dielectric constants of other materials are then compared to the dielectric constant of a vacuum.

Dielectric Thickness – Capacitance is indirectly proportional to the separation between electrodes. Lower voltage requirements mean thinner dielectrics and greater capacitance per volume.

Area – Capacitance is directly proportional to the area of the electrodes. Since the other variables in the equation are usually set by the performance desired, area is the easiest parameter to modify to obtain a specific capacitance within a material group.

Energy Stored – The energy which can be stored in a capacitor is given by the formula:

$$E = \frac{1}{2}CV^2$$

E = energy in joules (watts-sec)
 V = applied voltage
 C = capacitance in farads

Potential Change – A capacitor is a reactive component which reacts against a change in potential across it. This is shown by the equation for the linear charge of a capacitor:

$$I_{ideal} = C \frac{dV}{dt}$$

where

I = Current
 C = Capacitance
 dV/dt = Slope of voltage transition across capacitor

Thus an infinite current would be required to instantly change the potential across a capacitor. The amount of current a capacitor can “sink” is determined by the above equation.

Equivalent Circuit – A capacitor, as a practical device, exhibits not only capacitance but also resistance and inductance. A simplified schematic for the equivalent circuit is:

C = Capacitance

L = Inductance

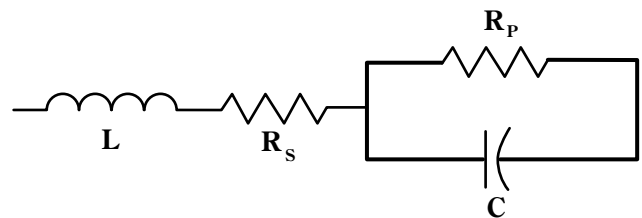

R_s = Series Resistance R_p = Parallel Resistance

Reactance – Since the insulation resistance (R_p) is normally very high, the total impedance of a capacitor is:

$$Z = \sqrt{R_s^2 + (X_C - X_L)^2}$$

where

Z = Total Impedance
 R_s = Series Resistance
 X_C = Capacitive Reactance = $\frac{1}{2\pi fC}$
 X_L = Inductive Reactance = $2\pi fL$

The variation of a capacitor’s impedance with frequency determines its effectiveness in many applications.

Phase Angle – Power Factor and Dissipation Factor are often confused since they are both measures of the loss in a capacitor under AC application and are often almost identical in value. In a “perfect” capacitor the current in the capacitor will lead the voltage by 90°.

General Description

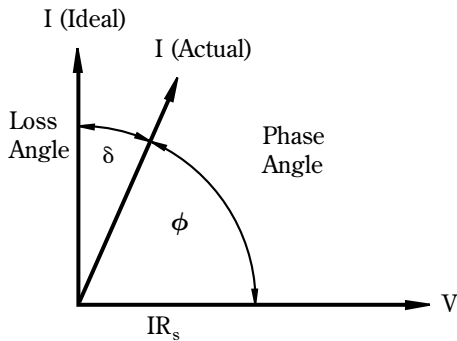

In practice the current leads the voltage by some other phase angle due to the series resistance R_s . The complement of this angle is called the loss angle and:

$$\text{Power Factor (P.F.)} = \cos \phi \text{ or } \sin \delta$$

$$\text{Dissipation Factor (D.F.)} = \tan \delta$$

for small values of δ the tan and sine are essentially equal which has led to the common interchangeability of the two terms in the industry.

Equivalent Series Resistance – The term E.S.R. or Equivalent Series Resistance combines all losses both series and parallel in a capacitor at a given frequency so that the equivalent circuit is reduced to a simple R-C series connection.

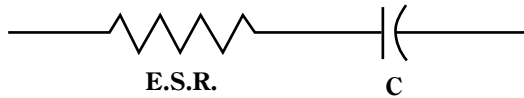

Dissipation Factor – The DF/PF of a capacitor tells what percent of the apparent power input will turn to heat in the capacitor.

$$\text{Dissipation Factor} = \frac{\text{E.S.R.}}{X_C} = (2 \pi fC) (\text{E.S.R.})$$

The watts loss are:

$$\text{Watts loss} = (2 \pi fCV^2) (\text{D.F.})$$

Very low values of dissipation factor are expressed as their reciprocal for convenience. These are called the “Q” or Quality factor of capacitors.

Parasitic Inductance – The parasitic inductance of capacitors is becoming more and more important in the decoupling of today’s high speed digital systems. The relationship between the inductance and the ripple voltage induced on the DC voltage line can be seen from the simple inductance equation:

$$V = L \frac{di}{dt}$$

The $\frac{di}{dt}$ seen in current microprocessors can be as high as 0.3 A/ns, and up to 10A/ns. At 0.3 A/ns, 100pH of parasitic inductance can cause a voltage spike of 30mV. While this does not sound very drastic, with the V_{cc} for microprocessors decreasing at the current rate, this can be a fairly large percentage.

Another important, often overlooked, reason for knowing the parasitic inductance is the calculation of the resonant frequency. This can be important for high frequency, bypass capacitors, as the resonant point will give the most signal attenuation. The resonant frequency is calculated from the simple equation:

$$f_{res} = \frac{1}{2\pi\sqrt{LC}}$$

Insulation Resistance – Insulation Resistance is the resistance measured across the terminals of a capacitor and consists principally of the parallel resistance R_P shown in the equivalent circuit. As capacitance values and hence the area of dielectric increases, the I.R. decreases and hence the product ($C \times IR$ or RC) is often specified in ohm farads or more commonly megohm-microfarads. Leakage current is determined by dividing the rated voltage by IR (Ohm’s Law).

Dielectric Strength – Dielectric Strength is an expression of the ability of a material to withstand an electrical stress. Although dielectric strength is ordinarily expressed in volts, it is actually dependent on the thickness of the dielectric and thus is also more generically a function of volts/mil.

Dielectric Absorption – A capacitor does not discharge instantaneously upon application of a short circuit, but drains gradually after the capacitance proper has been discharged. It is common practice to measure the dielectric absorption by determining the “reappearing voltage” which appears across a capacitor at some point in time after it has been fully discharged under short circuit conditions.

Corona – Corona is the ionization of air or other vapors which causes them to conduct current. It is especially prevalent in high voltage units but can occur with low voltages as well where high voltage gradients occur. The energy discharged degrades the performance of the capacitor and can in time cause catastrophic failures.

Surface Mounting Guide

MLC Chip Capacitors

REFLOW SOLDERING

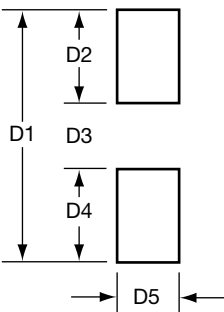

Case Size	D1	D2	D3	D4	D5
0201	0.85 (0.033)	0.30 (0.012)	0.25 (0.010)	0.30 (0.012)	0.35 (0.014)
0402	1.70 (0.067)	0.60 (0.024)	0.50 (0.020)	0.60 (0.024)	0.50 (0.020)
0603	2.30 (0.091)	0.80 (0.031)	0.70 (0.028)	0.80 (0.031)	0.75 (0.030)
0805	3.00 (0.118)	1.00 (0.039)	1.00 (0.039)	1.00 (0.039)	1.25 (0.049)
1206	4.00 (0.157)	1.00 (0.039)	2.00 (0.079)	1.00 (0.039)	1.60 (0.063)
1210	4.00 (0.157)	1.00 (0.039)	2.00 (0.079)	1.00 (0.039)	2.50 (0.098)
1808	5.60 (0.220)	1.00 (0.039)	3.60 (0.142)	1.00 (0.039)	2.00 (0.079)
1812	5.60 (0.220)	1.00 (0.039)	3.60 (0.142)	1.00 (0.039)	3.00 (0.118)
1825	5.60 (0.220)	1.00 (0.039)	3.60 (0.142)	1.00 (0.039)	6.35 (0.250)
2220	6.60 (0.260)	1.00 (0.039)	4.60 (0.181)	1.00 (0.039)	5.00 (0.197)
2225	6.60 (0.260)	1.00 (0.039)	4.60 (0.181)	1.00 (0.039)	6.35 (0.250)

Dimensions in millimeters (inches)

Component Pad Design

Component pads should be designed to achieve good solder fillets and minimize component movement during reflow soldering. Pad designs are given below for the most common sizes of multilayer ceramic capacitors for both wave and reflow soldering. The basis of these designs is:

- Pad width equal to component width. It is permissible to decrease this to as low as 85% of component width but it is not advisable to go below this.
- Pad overlap 0.5mm beneath component.
- Pad extension 0.5mm beyond components for reflow and 1.0mm for wave soldering.

WAVE SOLDERING

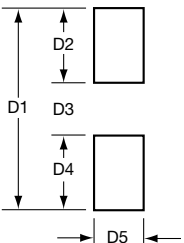

Case Size	D1	D2	D3	D4	D5
0603	3.10 (0.12)	1.20 (0.05)	0.70 (0.03)	1.20 (0.05)	0.75 (0.03)
0805	4.00 (0.15)	1.50 (0.06)	1.00 (0.04)	1.50 (0.06)	1.25 (0.05)
1206	5.00 (0.19)	1.50 (0.06)	2.00 (0.09)	1.50 (0.06)	1.60 (0.06)

Dimensions in millimeters (inches)

Component Spacing

For wave soldering components, must be spaced sufficiently far apart to avoid bridging or shadowing (inability of solder to penetrate properly into small spaces). This is less important for reflow soldering but sufficient space must be allowed to enable rework should it be required.

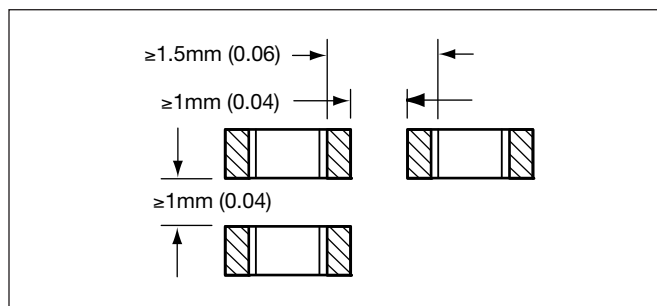

Preheat & Soldering

The rate of preheat should not exceed 4°C/second to prevent thermal shock. A better maximum figure is about 2°C/second.

For capacitors size 1206 and below, with a maximum thickness of 1.25mm, it is generally permissible to allow a temperature differential from preheat to soldering of 150°C. In all other cases this differential should not exceed 100°C.

For further specific application or process advice, please consult AVX.

Cleaning

Care should be taken to ensure that the capacitors are thoroughly cleaned of flux residues especially the space beneath the capacitor. Such residues may otherwise become conductive and effectively offer a low resistance bypass to the capacitor.

Ultrasonic cleaning is permissible, the recommended conditions being 8 Watts/litre at 20-45 kHz, with a process cycle of 2 minutes vapor rinse, 2 minutes immersion in the ultrasonic solvent bath and finally 2 minutes vapor rinse.

Surface Mounting Guide

Recommended Soldering Profiles

REFLOW SOLDER PROFILES

AVX RoHS compliant products utilize termination finishes (e.g. Sn or SnAg) that are compatible with all Pb-Free soldering systems and are fully reverse compatible with SnPb soldering systems. A recommended SnPb profile is shown for comparison; for Pb-Free soldering, IPC/JEDECJ-STD-020C may be referenced. The upper line in the chart shows the maximum envelope to which products are qualified (typically 3x reflow cycles at 260°C max). The center line gives the recommended profile for optimum wettability and soldering in Pb-Free Systems.

Preheat:

The pre-heat stabilizes the part and reduces the temperature differential prior to reflow. The initial ramp to 125°C may be rapid, but from that point (2-3)°C/sec is recommended to allow ceramic parts to heat uniformly and plastic encapsulated parts to stabilize through the glass transition temperature of the body (~ 180°C).

Reflow:

In the reflow phase, the maximum recommended time > 230°C is 40secs. Time at peak reflow is 10secs max.; optimum reflow is achieved at 250°C, (see wetting balance chart opposite) but products are qualified to 260°C max. Please reference individual product datasheets for maximum limits

Cool Down:

Cool down should not be forced and 6°C/sec is recommended. A slow cool down will result in a finer grain structure of the reflow solder in the solder fillet.

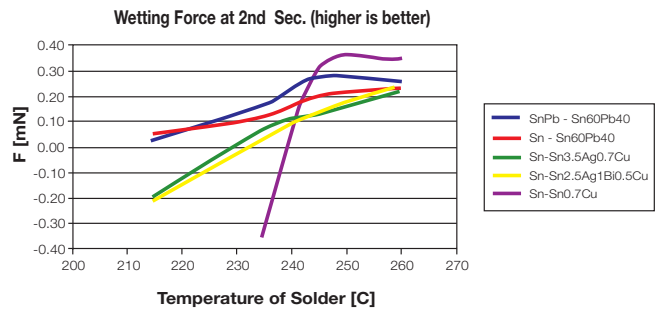
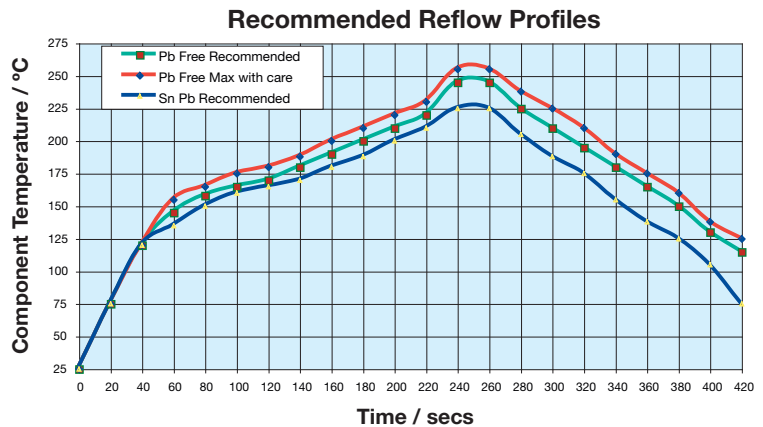

IMPORTANT NOTE: Typical Pb-Free reflow solders have a more dull and grainy appearance compared to traditional SnPb. Elevating the reflow temperature will not change this, but extending the cool down can help improve the visual appearance of the joint.

WAVE SOLDER PROFILES

For wave solder, there is no change in the recommended wave profile; all standard Pb-Free (SnCu/SnCuAg) systems operate at the same 260°C max recommended for SnPb systems.

Preheat:

This is more important for wave solder; a higher temperature preheat will reduce the thermal shock to SMD parts that are immersed (please consult individual product data sheets for SMD parts that are suited to wave solder). SMD parts should ideally be heated from the bottom-Side prior to wave. PTH (Pin through hole) parts on the topside should not be separately heated.

Wave:

250°C – 260°C recommended for optimum solderability.

Cool Down:

As with reflow solder, cool down should not be forced and 6°C/sec is recommended. Any air knives at the end of the 2nd wave should be heated.

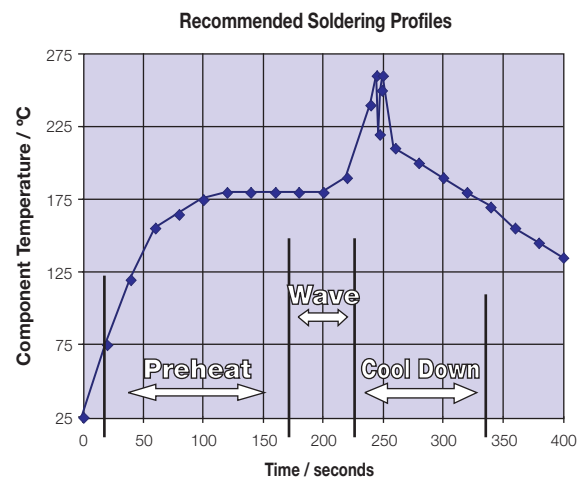

Surface Mounting Guide

MLC Chip Capacitors

APPLICATION NOTES

Storage

The components should be stored in their “as received packaging” where possible. If the components are removed from their original packaging then they should be stored in an airtight container (e.g. a heat sealed plastic bag) with desiccant (e.g. silica gel). Storage area temperature should be kept between +5 degrees C and +30 degrees C with humidity < 70% RH. Storage atmosphere must be free of gas containing sulfur and chlorine. Avoid exposing the product to saline moisture or to temperature changes that might result in the formation of condensation. To assure good solderability performance we recommend that the product be used within 6 months from our shipping date, but can be used for up to 12 months. Chip capacitors may crack if exposed to hydrogen (H₂) gas while sealed or if coated with silicon, which generates hydrogen gas.

Solderability

Terminations to be well soldered after immersion in a 60/40 tin/lead solder bath at 235 ± 5°C for 2 ± 1 seconds.

Leaching

Terminations will resist leaching for at least the immersion times and conditions shown below.

Termination Type	Solder Tin/Lead/Silver	Solder Temp. °C	Immersion Time Seconds
Nickel Barrier	60/40/0	260 ± 5	30 ± 1

Lead-Free Wave Soldering

The recommended peak temperature for lead-free wave soldering is 250°C-260°C for 3-5 seconds. The other parameters of the profile remains the same as above.

The following should be noted by customers changing from lead based systems to the new lead free pastes.

- The visual standards used for evaluation of solder joints will need to be modified as lead free joints are not as bright as with tin-lead pastes and the fillet may not be as large.
- Lead-free solder pastes do not allow the same self alignment as lead containing systems. Standard mounting pads are acceptable, but machine set up may need to be modified.

General

Surface mounting chip multilayer ceramic capacitors are designed for soldering to printed circuit boards or other substrates. The construction of the components is such that they will withstand the time/temperature profiles used in both wave and reflow soldering methods.

Handling

Chip multilayer ceramic capacitors should be handled with care to avoid damage or contamination from perspiration and skin oils. The use of tweezers or vacuum pick ups is strongly recommended for individual components. Bulk

handling should ensure that abrasion and mechanical shock are minimized. Taped and reeled components provides the ideal medium for direct presentation to the placement machine. Any mechanical shock should be minimized during handling chip multilayer ceramic capacitors.

Preheat

It is important to avoid the possibility of thermal shock during soldering and carefully controlled preheat is therefore required. The rate of preheat should not exceed 4°C/second and a target figure 2°C/second is recommended. Although an 80°C to 120°C temperature differential is preferred, recent developments allow a temperature differential between the component surface and the soldering temperature of 150°C (Maximum) for capacitors of 1210 size and below with a maximum thickness of 1.25mm. The user is cautioned that the risk of thermal shock increases as chip size or temperature differential increases.

Soldering

Mildly activated rosin fluxes are preferred. The minimum amount of solder to give a good joint should be used. Excessive solder can lead to damage from the stresses caused by the difference in coefficients of expansion between solder, chip and substrate. AVX terminations are suitable for all wave and reflow soldering systems. If hand soldering cannot be avoided, the preferred technique is the utilization of hot air soldering tools.

Cooling

Natural cooling in air is preferred, as this minimizes stresses within the soldered joint. When forced air cooling is used, cooling rate should not exceed 4°C/second. Quenching is not recommended but if used, maximum temperature differentials should be observed according to the preheat conditions above.

Cleaning

Flux residues may be hygroscopic or acidic and must be removed. AVX MLC capacitors are acceptable for use with all of the solvents described in the specifications MIL-STD-202 and EIA-RS-198. Alcohol based solvents are acceptable and properly controlled water cleaning systems are also acceptable. Many other solvents have been proven successful, and most solvents that are acceptable to other components on circuit assemblies are equally acceptable for use with ceramic capacitors.

Prevention of Metallic Migration

Note that when components with Sn plating on the end terminations are to be used in applications that are likely to experience conditions of high humidity under bias voltage, we strongly recommend that the circuit boards be conformally coated to protect the Sn from moisture that might lead to migration and eventual current leakage.

When using Capacitor Arrays we recommend that there is no differential in applied voltage between adjacent elements.

Surface Mounting Guide

MLC Chip Capacitors

POST SOLDER HANDLING

Once SMP components are soldered to the board, any bending or flexure of the PCB applies stresses to the soldered joints of the components. For leaded devices, the stresses are absorbed by the compliancy of the metal leads and generally don't result in problems unless the stress is large enough to fracture the soldered connection.

Ceramic capacitors are more susceptible to such stress because they don't have compliant leads and are brittle in nature. The most frequent failure mode is low DC resistance or short circuit. The second failure mode is significant loss of capacitance due to severing of contact between sets of the internal electrodes.

Cracks caused by mechanical flexure are very easily identified and generally take one of the following two general forms:

Mechanical cracks are often hidden underneath the termination and are difficult to see externally. However, if one end termination falls off during the removal process from PCB, this is one indication that the cause of failure was excessive mechanical stress due to board warping.



Type A:
Angled crack between bottom of device to top of solder joint.

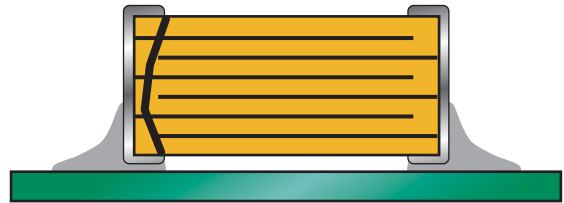

Type B:
Fracture from top of device to bottom of device.

Surface Mounting Guide

MLC Chip Capacitors

COMMON CAUSES OF MECHANICAL CRACKING

The most common source for mechanical stress is board depanelization equipment, such as manual breakapart, v-cutters and shear presses. Improperly aligned or dull cutters may cause torqueing of the PCB resulting in flex stresses being transmitted to components near the board edge. Another common source of flexural stress is contact during parametric testing when test points are probed. If the PCB is allowed to flex during the test cycle, nearby ceramic capacitors may be broken.

A third common source is board to board connections at vertical connectors where cables or other PCBs are connected to the PCB. If the board is not supported during the plug/unplug cycle, it may flex and cause damage to nearby components.

Special care should also be taken when handling large (>6" on a side) PCBs since they more easily flex or warp than smaller boards.

REWORKING OF MLCs

Thermal shock is common in MLCs that are manually attached or reworked with a soldering iron. *AVX strongly recommends that any reworking of MLCs be done with hot air reflow rather than soldering irons.* It is practically impossible to cause any thermal shock in ceramic capacitors when using hot air reflow.

However direct contact by the soldering iron tip often causes thermal cracks that may fail at a later date. If rework by soldering iron is absolutely necessary, it is recommended that the wattage of the iron be less than 30 watts and the tip temperature be <math><300^{\circ}\text{C}</math>. *Rework should be performed by applying the solder iron tip to the pad and not directly contacting any part of the ceramic capacitor.*

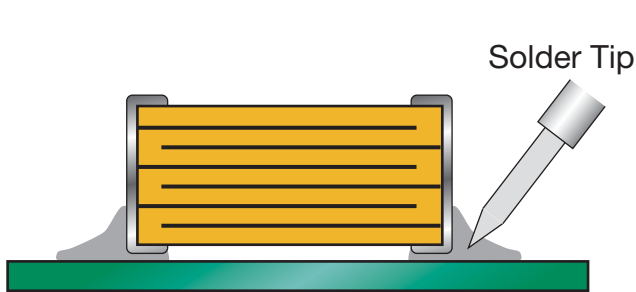

Preferred Method - No Direct Part Contact

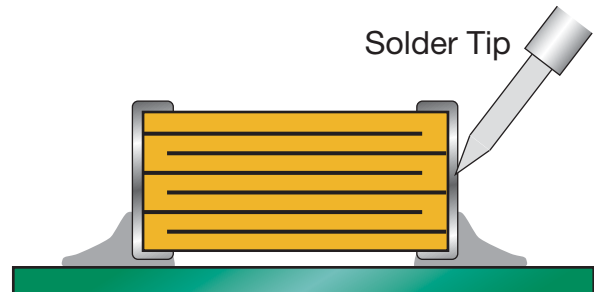

Poor Method - Direct Contact with Part

PCB BOARD DESIGN

To avoid many of the handling problems, AVX recommends that MLCs be located at least .2" away from nearest edge of board. However when this is not possible, AVX recommends that the panel be routed along the cut line, adjacent to where the MLC is located.

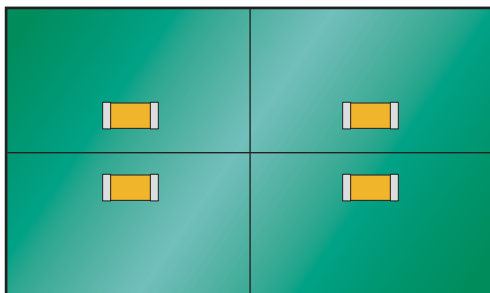

No Stress Relief for MLCs

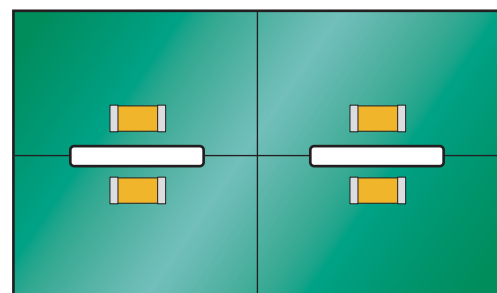

Routed Cut Line Relieves Stress on MLC

AMERICAS

AVX Greenville, SC
Tel: 864-967-2150

EUROPE

AVX Limited, England
Tel: +44-1276-697000

AVX S.A.S., France
Tel: +33-1-69-18-46-00

AVX GmbH, Germany
Tel: +49-0811-95949-0

AVX SRL, Italy
Tel: +39-02-614-571

AVX Czech Republic
Tel: +420-57-57-57-521

AVX/ELCO UK
Tel: +44-1638-675000

ELCO Europe GmbH
Tel: +49-2741-299-0

AVX S.A., Spain
Tel: +34-91-63-97-197

AVX Benelux
Tel: +31-187-489-337

ASIA-PACIFIC

AVX/Kyocera (S) Pte Ltd.,
Singapore
Tel: +65-6286-7555

AVX/Kyocera, Asia, Ltd.,
Hong Kong
Tel: +852-2363-3303

AVX/Kyocera Yuhan Hoesa,
South Korea
Tel: +82-2785-6504

AVX/Kyocera HK Ltd.,
Taiwan
Tel: +886-2-2656-0258

AVX/Kyocera (M) Sdn Bhd,
Malaysia
Tel: +60-4228-1190

AVX/Kyocera International
Trading Co. Ltd.,
Shanghai
Tel: +86-21-3255 1933

AVX/Kyocera Asia Ltd.,
Shenzen
Tel: +86-755-3336-0615

AVX/Kyocera International
Trading Co. Ltd.,
Beijing
Tel: +86-10-6588-3528

AVX/Kyocera India
Liaison Office
Tel: +91-80-6450-0715

ASIA-KED

(KYOCERA Electronic Devices)

KED Hong Kong Ltd.
Tel: +852-2305-1080/1223

KED Hong Kong Ltd.
Shenzen
Tel: +86-755-3398-9600

KED Company Ltd.
Shanghai
Tel: +86-21-3255-1833

KED Hong Kong Ltd.
Beijing
Tel: +86-10-5869-4655

KED Taiwan Ltd.
Tel: +886-2-2950-0268

KED Korea Yuhan Hoesa,
South Korea
Tel: +82-2-783-3604/6126

KED (S) Pte Ltd.
Singapore
Tel: +65-6509-0328

Kyocera Corporation
Japan
Tel: +81-75-604-3449

Contact:



<http://www.avx.com>

S-MLCC0716-C