

# DIN RAIL ENCLOSURES

## CVB-PLUS Series

- 22.5mm wide Vertical DIN Rail Mount Housing
- Clip together design for fast assembly
- Supplied with four 4-pole 5mm pitch pluggable terminal blocks
- 16 positions
- Moulded in UL94-V0, PA66
- Front and side label recesses
- Solid and vented versions available
- Top Hat 35mm DIN Rail or Surface Mounting

### SPECIFICATION

Rating Terminals	15A 300V
Contact resistance	20mΩ
Insulation resistance	500mΩ/DC500V
Withstand voltage	AC2000V/1min
Materials: Pin header	Brass, tin plated
Housing	PA66, UL94-V0

### TYPE NO.

TYPE NO.	DESCRIPTION	SIZE
CVB-PLUS1	Solid sides	112mm x 22.5mm x 99mm
CVB-PLUS1V	Vented Sides	112mm x 22.5mm x 99mm

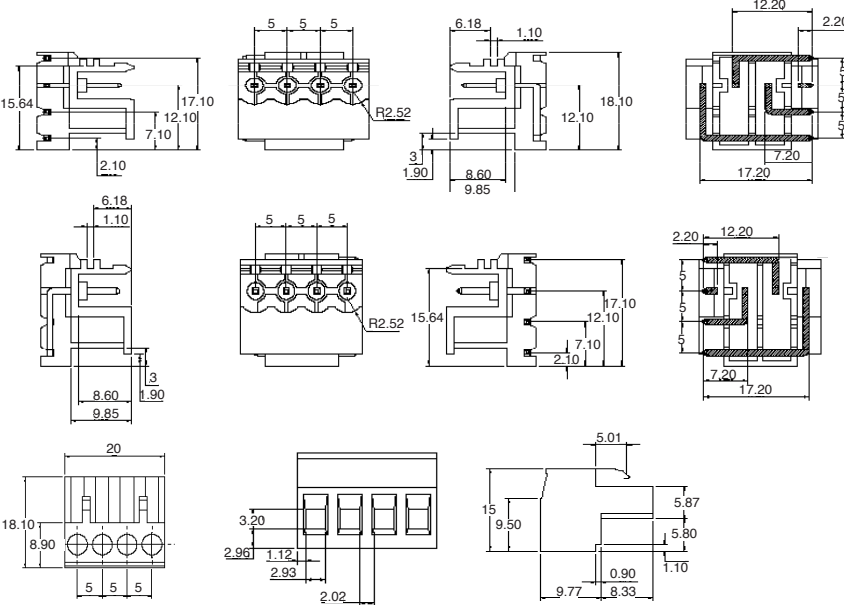
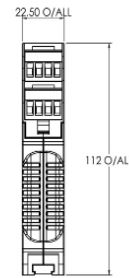
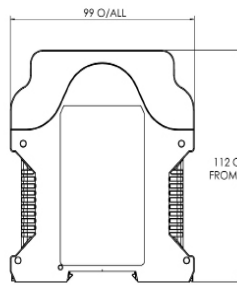
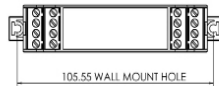
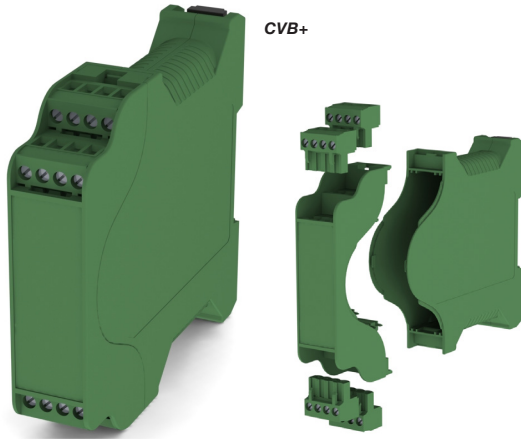

CVBP935L/4



CVBP935R/4



CVBP9200/4

## CVB-PLUS PCB

- Material: 2-layer FR4
- X826 1.3mm dia holes
- X16 1.5mm dia holes (reserved for Terminal Blocks)

TYPE NO.	DESCRIPTION	SIZE
CVB-PLUS-PCB	PCB	80mm x 99.2mm x 1.6mm

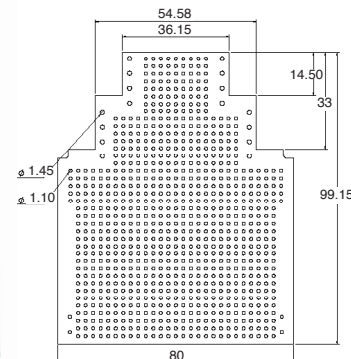
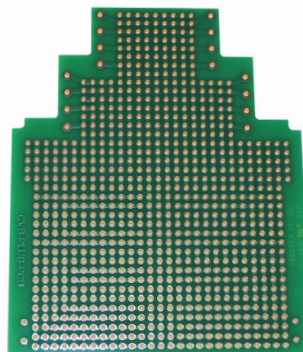

UNIVERSAL ENCLOSURES

HAND HELD CASES

HEAVY DUTY ENCLOSURES

DIN RAIL ENCLOSURES

INTERFACE SUPPORTS

ELECTRICAL ENCLOSURES

DIECAST & METAL ENCLOSURES

DESKTOP & INSTRUMENT CASES

POTTING BOXES

19" ENCLOSURES

19" CABINETS

DEVELOPMENT BOARD ENCLOSURES

CUSTOM SIZED ENCLOSURES

CUSTOM SERVICES