

Design Example Report

Title	<i>12 W Non-Dimmable Non-Isolated Buck-Boost LED Driver Using LYTSwitch™-5 LYT5226D</i>
Specification	90 VAC – 308 VAC Input; 69 V – 82 V, 160 mA _{TYP} Output
Application	LED Tube
Author	Applications Engineering Department
Document Number	DER-515
Date	March 30, 2016
Revision	1.1

Summary and Features

- Wide input voltage range
- Single-stage power factor corrected, PF >0.9
- Accurate constant LED current (CC) regulation, ±5%
- Highly energy efficient, >89% at 230 V
- Low cost and low component count for compact PCB solution
- Integrated protection features
 - No-load and output short-circuit protection
 - Thermal control protection
 - No damage during line brown-out or brown-in conditions
- A-THD <15% at 230 VAC
- Meets IEC 3.5 kV ring wave, 3 kV differential surge
- Meets EN55015 conducted EMI

PATENT INFORMATION

The products and applications illustrated herein (including transformer construction and circuits external to the products) may be covered by one or more U.S. and foreign patents, or potentially by pending U.S. and foreign patent applications assigned to Power Integrations. A complete list of Power Integrations' patents may be found at www.powerint.com. Power Integrations grants its customers a license under certain patent rights as set forth at <http://www.powerint.com/ip.htm>.

Power Integrations

5245 Hellyer Avenue, San Jose, CA 95138 USA.
Tel: +1 408 414 9200 Fax: +1 408 414 9201
www.power.com

Table of Contents

1	Introduction	4
2	Power Supply Specification	6
3	Schematic	7
4	Circuit Description	8
4.1	Input Stage	8
4.2	EMI Filters	8
4.3	LYTSwitch-5 Primary Control Circuit	8
5	PCB Layout	10
6	Bill of Materials	11
7	Transformer Specification	12
7.1	Electrical Diagram	12
7.2	Electrical Specifications	12
7.3	Material List	12
7.4	Transformer Build Diagram	13
7.5	Transformer Construction	13
7.6	Winding Illustrations	14
8	Inductor Design Spreadsheet	20
9	Performance Data	22
9.1	Efficiency	22
9.2	Line Regulation	23
9.3	Power Factor	24
9.4	%ATHD	25
9.5	Harmonics	26
9.5.1	70 V LED Load	26
9.5.2	75 V LED Load	27
9.5.3	81 V LED Load	28
10	Test Data	29
10.1	Test Data, 70 V LED Load	29
10.2	Test Data, 75 V LED Load	29
10.3	Test Data, 81 V LED Load	30
10.4	Test Data, Harmonic Content at 230 VAC with 70 V LED Load	30
10.5	Test Data, Harmonic Content at 230 VAC with 75 V LED Load	31
10.6	Test Data, Harmonic Content at 230 VAC with 81 V LED Load	32
11	Thermal Performance at 25 °C	33
11.1	Thermal Performance at 120 VAC	33
11.2	Thermal Performance at 230 VAC	34
12	Thermal Performance at 100 °C	36
12.1	Set-up	36
12.2	Thermal Performance with Respect to the Line Voltage	37
12.3	Output Current Regulation at 120 VAC Input	38
12.4	Output Current Regulation at 230 VAC Input	39
13	Waveforms	40



13.1	Input Voltage and Input Current Waveforms	40
13.2	Output Current Rise and Fall	42
13.3	Drain Voltage and Current in Normal Operation	45
13.4	Drain Voltage and Current Start-up Profile.....	49
13.5	Drain Voltage and Current during Output Short-Circuit Condition	53
13.6	Output Diode Voltage and Current in Normal Operation	57
13.7	Output Voltage and Current - Open LED Load	61
13.8	Output Ripple Current	63
14	AC Cycling Test.....	65
15	Conducted EMI	66
15.1	Test Set-up	66
15.1.1	Equipment and Load Used	66
15.2	EMI Test Result	67
16	Line Surge.....	69
17	Brown-in / Brown-out Test	82
18	Revision History	83

Important Note: Although this board is designed to satisfy safety isolation requirements, the engineering prototype has not been agency approved. Therefore, all testing should be performed using an isolation transformer to provide the AC input to the prototype board.

1 Introduction

This engineering report describes a non-dimmable, non-isolated buck-boost LED driver designed to drive a nominal LED voltage string of 75 V at 160 mA from a wide input voltage range of 90 VAC to 308 VAC. The LED driver utilizes the LYT5226D from the LYTSwitch-5 family of devices.

The LYTSwitch-5 is a family of devices which are designed especially for non-dimmable wide range ac input LED drivers with a single stage PFC function and accurate LED current control.

The DER-515 provides a single 12 W constant current output. The key design goals were high efficiency, low THD, low component count and low height profile. This design is intended for tube LED applications.

The document contains the power supply specification, schematic, bill of materials, transformer documentation, printed circuit layout, design spreadsheet and performance data.

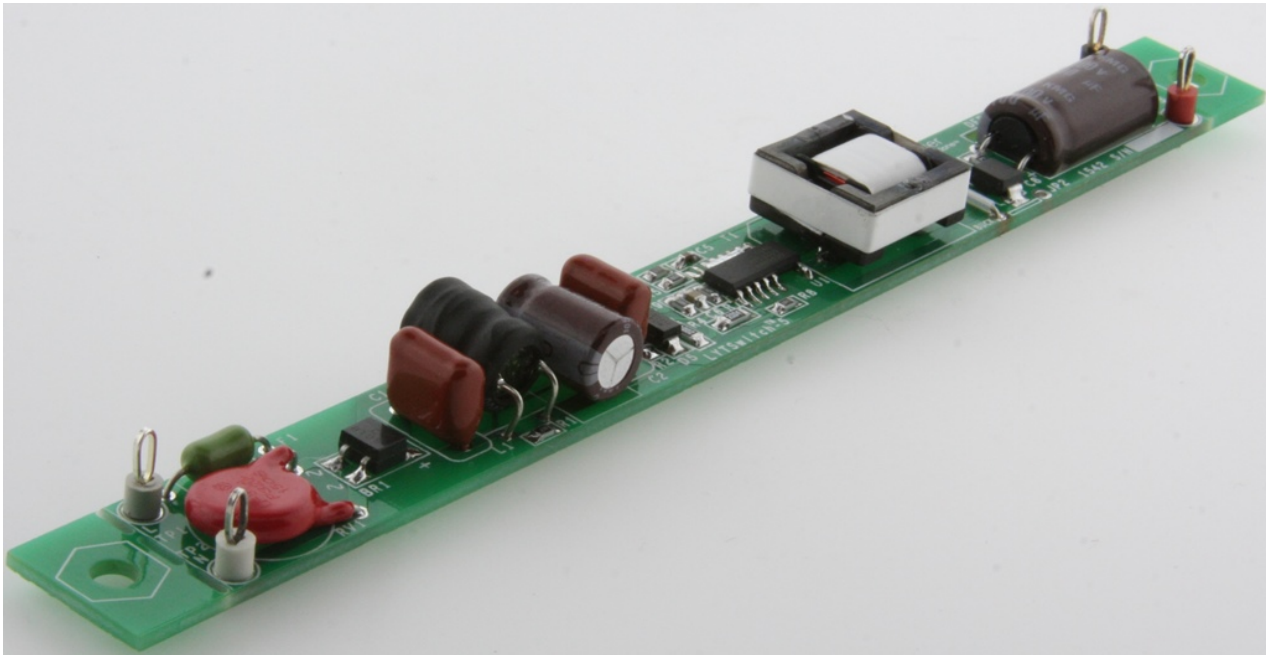

Figure 1 – Populated Circuit Board.



Figure 2 – Populated Circuit Board, Top View.



Figure 3 – Populated Circuit Board, Bottom View.

2 Power Supply Specification

The table below represents the minimum acceptable performance of the design. Actual performance is listed in the results section.

Description	Symbol	Min	Typ	Max	Units	Comment
Input						
Voltage (Low Line)	V_{IN}	90	120	132	VAC	2 Wire – no P.E.
Voltage (High Line)		185	230	308		
Frequency	f_{LINE}		50/60		Hz	
Output						
Output Voltage	V_{OUT}	69	75	82	V	
Output Current	I_{OUT}	152	160	168	mA	
Total Output Power						
Continuous Output Power	P_{OUT}		12		W	
Efficiency						
Full Load	η		89		%	Measured at 230 VAC, 25 °C.
Environmental						
Conducted EMI		CISPR 15B / EN55015B				
Safety		Isolated				
Ring Wave (100 kHz)			3.5		kV	
Differential Surge (L1-L2)			3		kV	
Power Factor		0.9				Measured at 230 VAC, 50 Hz.
Ambient Temperature	T_{AMB}			40	°C	Free convection, sea level.

3 Schematic

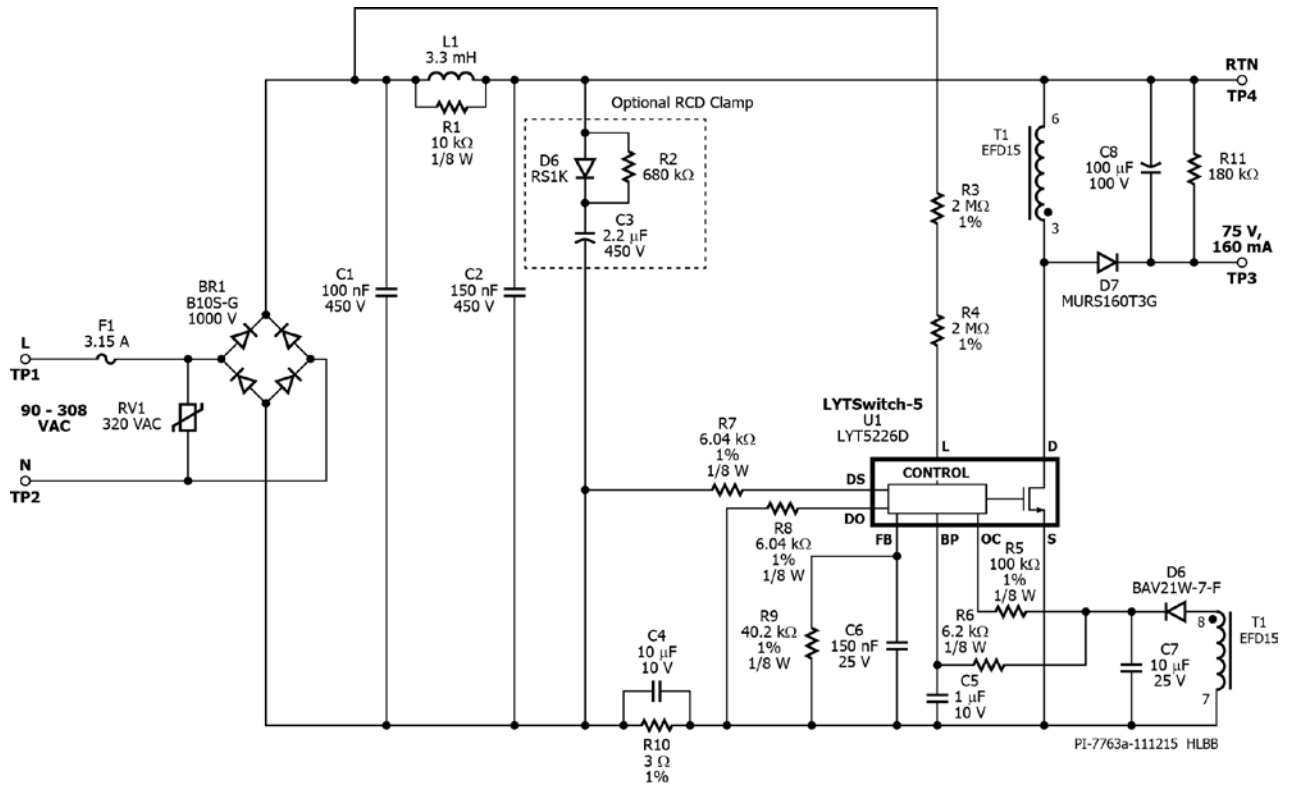

Figure 4 – Schematic.

Note: JP1 is mounted for the buck-boost topology, while JP2 is for the buck topology.



4 Circuit Description

The LYTSwitch-5 LYT5226D combines a high-voltage power MOSFET switch with a power supply controller in a single package. The LYTSwitch-5 controller provides a single-stage power factor correction and LED current control.

4.1 Input Stage

Fuse F1 provides protection against component short circuit failure drawing large current from the input. Varistor RV1 acts as a clamp to limit the maximum voltage spike on the primary during differential line surge events. A 320 VAC rated part was selected, being slightly above the maximum specified operating voltage (308 VAC).

To provide input line voltage information to U1, the input AC voltage is sense after the bridge rectifier diode. The (L) pin current set through resistor R3 and R4 is use to activate input OVP functions and to control the output LED current with respect to line.

The AC input is full wave rectified by BR1 to provide the pulsating DC input to the π filter.

4.2 EMI Filters

The differential choke L1, together with the input filter capacitor C1 and C2 work as an EMI π filter. These EMI filters, together with the LYTSwitch-5 frequency jittering feature ensure compliance with the EN55015 Class B emission limit.

The values of C1, C2 and L1 were chosen to provide the best balance between high efficiency, power factor and EMI performance.

4.3 LYTSwitch-5 Primary Control Circuit

The topology is a buck-boost with a low-side switch. The primary winding (buck-boost inductor) un-dotted end of the transformer (T1) is connected to the DC bus and the dotted end terminal to the DRAIN (D) pin of the LYTSwitch-5 IC. During the on-time of the power MOSFET, current ramps through the primary winding, storing energy in the magnetizing inductance which is then delivered to the output load via output diode D7 during the power MOSFET off-time. Output capacitor C8 provides output voltage filtering minimizing the output LED ripple current and helps to achieve good response of output current rise during start-up. Resistor R11 serves as a 30 mW pre-load.

Capacitor C5 provides local decoupling for the BYPASS (BP) pin of U1, which is the supply pin for the IC. During start-up, C5 is charged to ~5.25 V from an internal high-voltage current source connected to the D pin.

Diode D6 and C7 provides the primary bias supply for U1 from an auxiliary winding on the transformer. This external bias supply set through R6 is necessary to give the lowest device dissipation and provide sufficient supply to U1 after start-up.

With reference to the (FB) pin full conduction preset threshold of 300 mV, a corresponding voltage across R10 senses the output LED current through U1 drain current and then fed into the DS pin via R8 to maintain the output constant current regulation. This voltage is compared to the voltage across R9 internally to the 300 mV reference voltage. The capacitor C6 provides voltage filtering to generate a DC reference voltage and to reduce ripple voltage spike.

IC U1 (OC) pin senses the output voltage through R5 for the output OVP functions when open load and for optimized LED current regulation with respect to variation in LED string voltage. Output OVP is activated with the IC latching off when the (OC) pin voltage exceeds the OV threshold.



5 PCB Layout

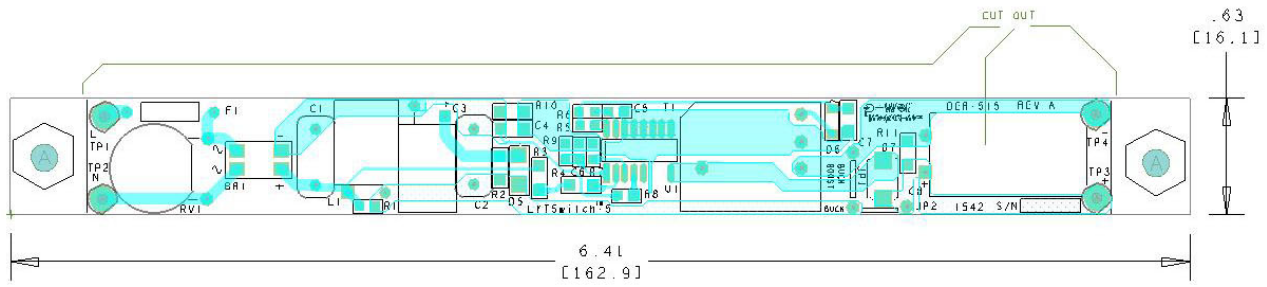

Figure 5 – Top Side.

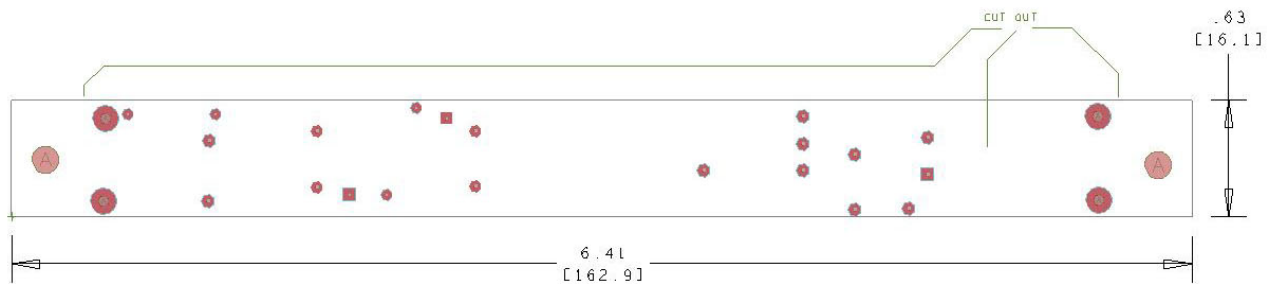

Figure 6 – Bottom Side.



6 Bill of Materials

Item	Qty	Ref Des	Description	Mfg Part Number	Manufacturer
1	1	BR1	1000 V, 0.8 A, Bridge Rectifier, SMD, MBS-1, 4-SOIC	B10S-G	Comchip
2	1	C1	100 nF, 450 V, Film	MEXXD31004JJ1	Duratech
3	1	C2	150 nF, 450 V, 10%, Polypropylene Metalized	C222S154K30	Faratronic
4	1	C3	2.2 μ F, 450 V, Electrolytic, (8 x 11.5)	UVK2W2R2MPD1TD	Nichicon
5	1	C4	10 μ F, 10 V, Ceramic, X7R, 1206	C3216X7R1A106M160AC	TDK
6	1	C5	1 μ F, 10 V, Ceramic, X7R, 0805	CL21B105MPFNNE	Samsung
7	1	C6	150 nF, 25 V, Ceramic, X7R, 0805	C0805C154K3RACTU	Kemet
8	1	C7	10 μ F, 25 V, Ceramic, X7R, 1206	C3216X7R1E106M	TDK
9	1	C8	100 μ F, 100 V, Electrolytic, Gen. Purpose, (10 x 20)	EKMG101ELL101MJ20S	United Chemi-con
10	1	D5	800 V, 1 A, Fast Recovery, 250 ns, SMA	RS1K-13-F	Diodes, Inc.
11	1	D6	250 V, 0.2 A, Fast Switching, 50 ns, SOD-123	BAV21W-7-F	Diodes, Inc.
12	1	D7	600 V, 1 A, Ultrafast Recovery, 35 ns, SMB Case	MURS160T3G	On Semi
13	1	F1	3.15 A, 250 V, Slow, 3.6 mm x 10 mm, Axial	08773.15MXEP	Littlefuse
14	1	L1	3.3 mH, 0.150 A, 20%	RL-5480-3-3300	Renco
15	1	R1	10 k Ω , 5%, 1/8 W, Thick Film, 0805	ERJ-6GEYJ103V	Panasonic
16	1	R2	680 k Ω , 5%, 1/4 W, Thick Film, 1206	ERJ-8GEYJ684V	Panasonic
17	1	R3	2.00 M Ω , 1%, 1/4 W, Thick Film, 1206	ERJ-8ENF2004V	Panasonic
18	1	R4	2.00 M Ω , 1%, 1/4 W, Thick Film, 1206	ERJ-8ENF2004V	Panasonic
19	1	R5	100 k Ω , 1%, 1/8 W, Thick Film, 0805	ERJ-6ENF1003V	Panasonic
20	1	R6	6.2 k Ω , 5%, 1/8 W, Thick Film, 0805	ERJ-6GEYJ622V	Panasonic
21	1	R7	6.04 k Ω , 1%, 1/8 W, Thick Film, 0805	ERJ-6ENF6041V	Panasonic
22	1	R8	6.04 k Ω , 1%, 1/8 W, Thick Film, 0805	ERJ-6ENF6041V	Panasonic
23	1	R9	40.2 k Ω , 1%, 1/8 W, Thick Film, 0805	ERJ-6ENF4022V	Panasonic
24	1	R10	3.00 Ω , 1%, 1/4 W, Thick Film, 1206	RC1206FR-073RL	Yageo
25	1	R11	180 k Ω , 5%, 1/4 W, Thick Film, 1206	ERJ-8GEYJ184V	Panasonic
26	1	RV1	320 V, 48 J, 10 mm, RADIAL	V320LA10P	Littlefuse
27	1	T1	Bobbin, EFD15, Horizontal, 8 pins Transformer	B66414-B1008-DA POL-LYT034	Epcos Premier Magnetics
28	1	U1	LYTSwitch-5, SO-16C	LYT5226D	Power Integrations

Miscellaneous Parts					
Item	Qty	Ref Des	Description	Mfg Part Number	Manufacturer
1	1	TP1	Test Point, BLU, THRU-HOLE MOUNT	5127	Keystone
2	1	TP2	Test Point, WHT, THRU-HOLE MOUNT	5012	Keystone
3	1	TP3	Test Point, RED, THRU-HOLE MOUNT	5010	Keystone
4	1	TP4	Test Point, BLK, THRU-HOLE MOUNT	5011	Keystone

7 Transformer Specification

7.1 Electrical Diagram

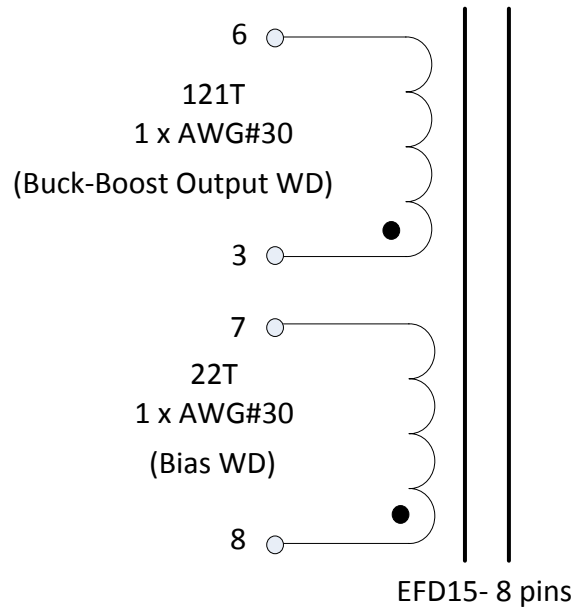

Figure 7 – Inductor Electrical Diagram.

7.2 Electrical Specifications

Parameter	Condition	Spec.
Nominal Primary Inductance	Measured at 1 V pk-pk, 100 kHz switching frequency, between pin 3 and pin 6, with all other windings open.	325 μ H
Tolerance	Tolerance of primary inductance.	\pm 5%

7.3 Material List

Item	Description
[1]	Core: EFD15.
[2]	Bobbin, EEF15, Horizontal, 8 pins, Part No: B66414-B1008-DA.
[3]	Magnet Wire: #30 AWG.
[4]	Transformer tape: 9.5 mm.
[5]	Transformer tape: 4 mm.
[6]	Transformer varnish.

7.4 Transformer Build Diagram

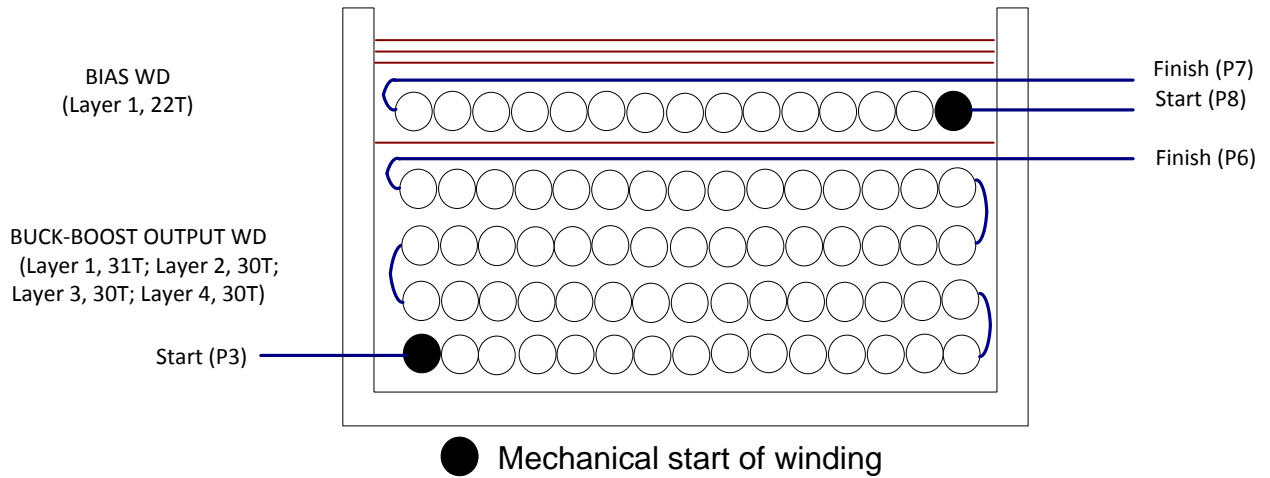

Figure 8 – Transformer Build Diagram.

7.5 Transformer Construction

Winding Directions	Bobbin is oriented on winder jig such that terminal pin 1-4 is at the top left side. The winding direction is counter-clockwise towards the operator.
Winding 1	Use wire item [3], start at pin 3 and wind 121 turns in 4 layers, then finish the winding at pin 6.
Insulation	Add 1 layer of tape, item [4], for insulation.
Winding 2	Use wire item [3], start at pin 8 and wind 22 turns in 1 layer, then finish the winding at pin 7.
Insulation	Add 3 layer of tape, item [4], for insulation.
Core Grinding	Grind the center leg of one core until it meets the nominal inductance of 325 μ H.
Assemble Core	Assemble the 2 cores on the bobbin and wrap with 3 layer of tape, Item (5).
Pins	Pull out terminal pin no. 1, 2, 4 and 5.
Finish	Dip the transformer assembly in varnish.

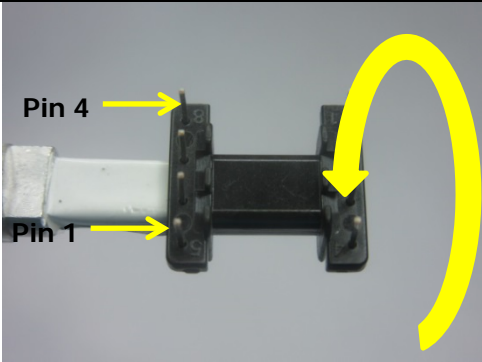
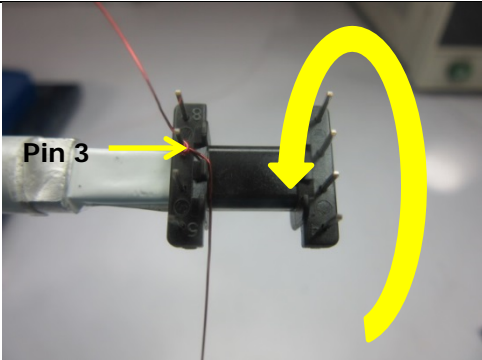
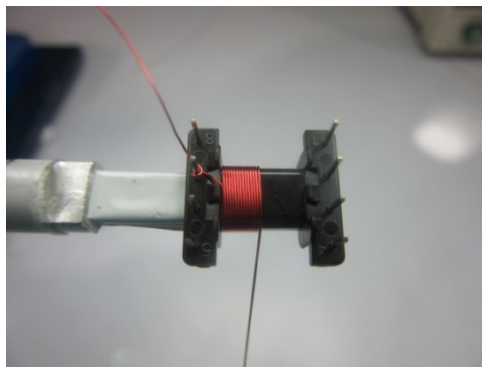
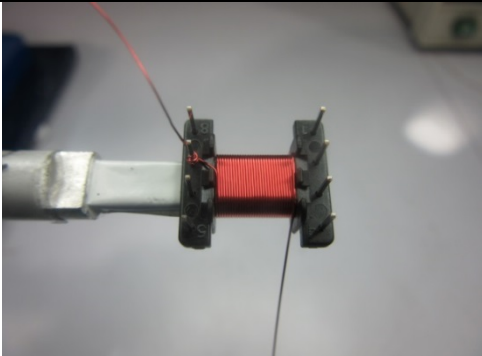

7.6 *Winding Illustrations*

<p>Winding Orientation</p>		<p>Bobbin is oriented on the mandrel winder jig such that terminal pins 1-4 are on the left-hand side.</p>
<p>Winding Procedure (Main Winding: 1st layer)</p>		<p>Use wire item [3], start at pin 3 and wind 31 turns in 1 layer. The winding direction is counter-clockwise towards the operator. Do not terminate yet. Continue winding as described in the next procedure.</p>
		<p>Midway through the 1st layer. Winding turns increment from left to right.</p>
		<p>At the end of the 1st layer and beginning of the 2nd layer.</p>

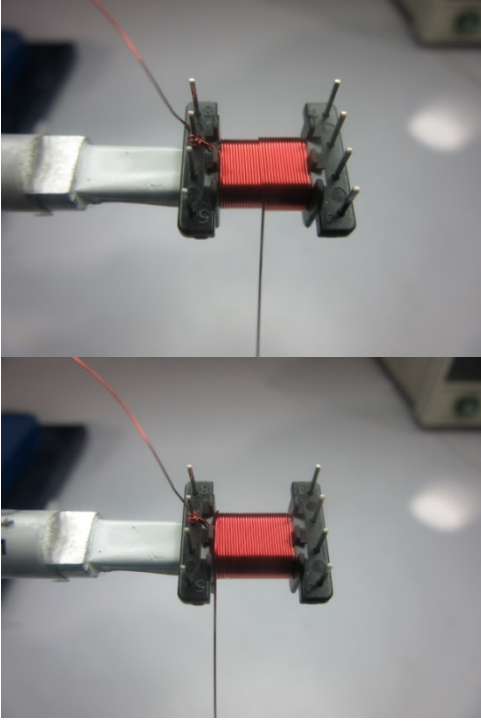
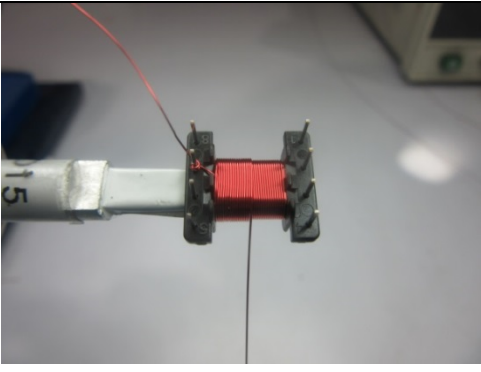
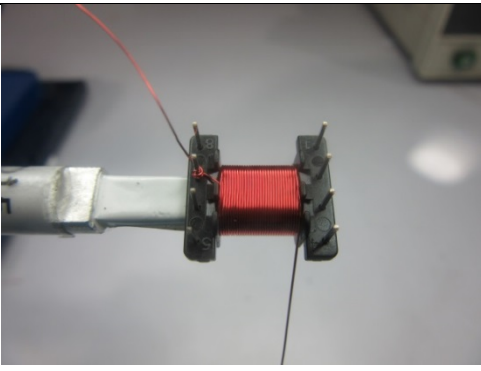
<p>Winding Procedure (Main Winding: 2nd to 4th Layer)</p>		<p>Midway through the 2nd layer. Winding turns increment from right to left. Coming from the previous procedure, for the 2nd layer, wind 30 turns on each layer from the 2nd up to the 4th layer to complete the 121 turns for the main winding.</p> <p>At the end of the 2nd layer and beginning of the 3rd layer.</p>
		<p>Midway through the 3rd layer. Winding turns increment from left to right.</p>
		<p>At the end of the 3rd layer and beginning of the 4th layer.</p>

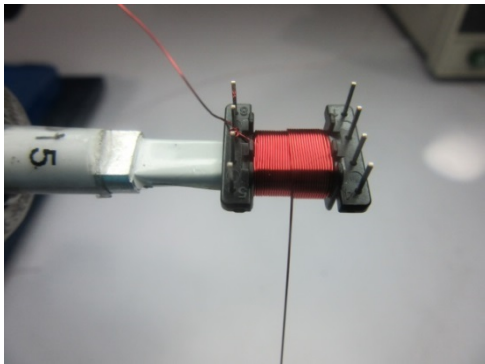
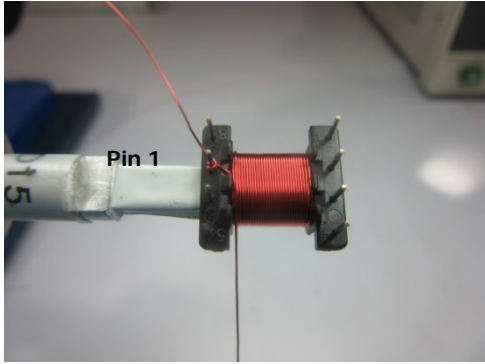
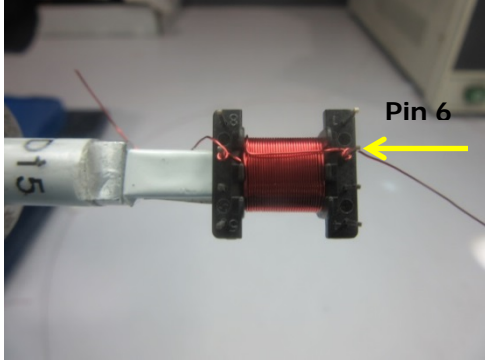
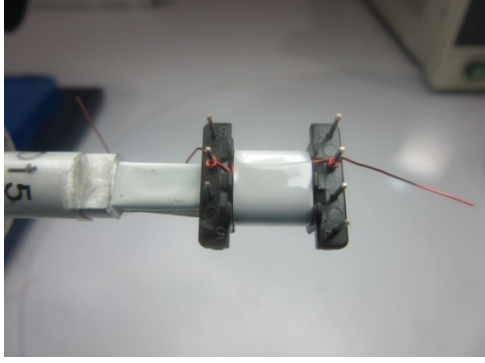
		<p>Midway through the 4th layer. Winding turns increment from right to left.</p>
		<p>At the end of the 4th and the last layer for the main winding.</p>
		<p>At the end of the last turn on the 4th layer, as soon as it made the turn as shown, bend it horizontally along the winding window towards the opposite side and terminate on pin 6.</p> <p><i>Note: Optional - Firmly fix in place the bended corner of the wire with a small tape before terminating it.</i></p>
<p>Insulation</p>		<p>Add 1 layer of tape, item [4], for insulation.</p>

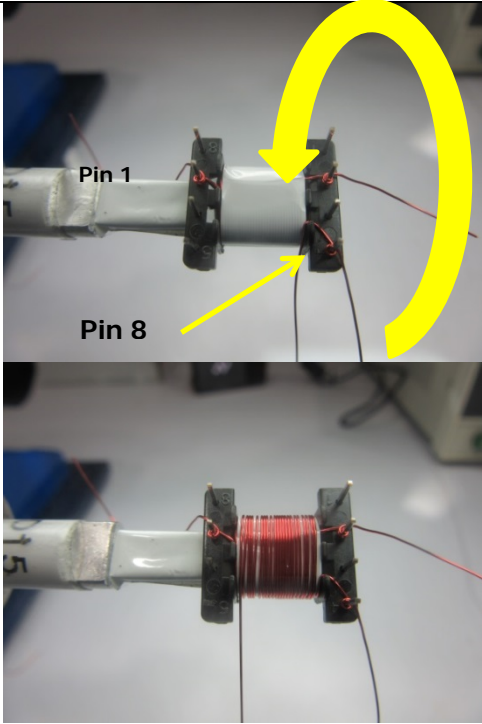
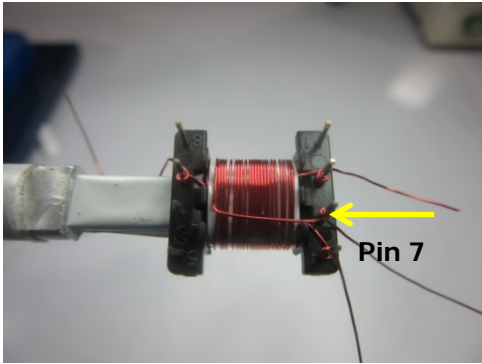
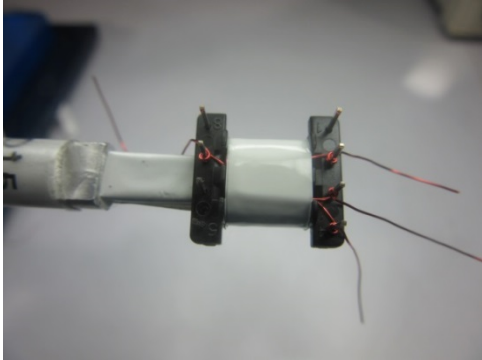
<p>Winding Procedure (Bias Winding)</p>		<p>Use wire item [3], start at pin 8 and wind 22 turns in 1 layer. The winding direction is counter-clockwise towards the operator. Winding turns increment from right to left. Evenly distribute the turns along the length of the winding window.</p> <p>At the end of the single layer of the bias winding.</p>
		<p>At the end of the last turn on the single layer of the bias winding, as soon as it made the turn as shown, bend it horizontally along the winding window towards the opposite side and terminate on pin 7.</p> <p><i>Note: Optional - Firmly fix in place the bended corner of the wire with a small tape before terminating it.</i></p>
<p>Insulation</p>		<p>Add 3 layers of tape, item [4], for insulation.</p>

<p>Finishing</p>		<p>Trim the wires and solder on the terminals.</p> <p><i>Note: Optional - The wire that was started on pin 8 should be removed from the wire-termination groove guide (slot separation) of pin 7 by pulling back a little in counter-clockwise towards the operator and should still be connected on pin 8.</i></p>
		<p>Get the EFD15 cores and grind it until it reaches the nominal inductance of 325uH.</p>
		<p>Measure the inductance between terminals 3 and 6. Should be 325 uH ±5%.</p>
		<p>Cut pins 1, 2, 4 and 5. Assemble the cores onto the bobbin accordingly.</p>

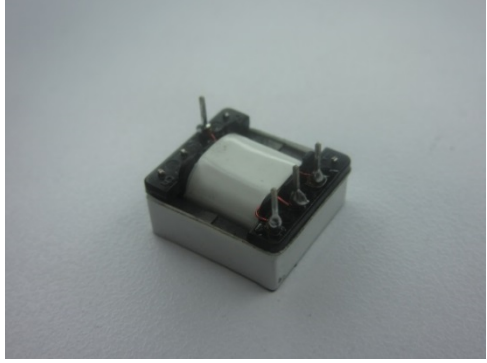
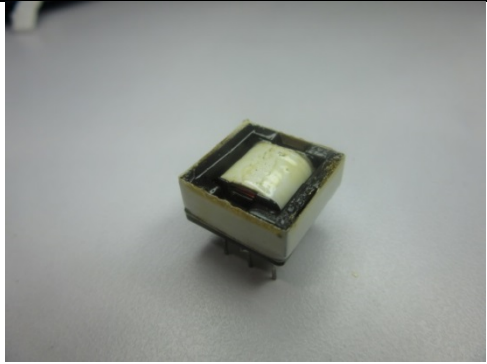
	 A photograph of a transformer assembly. It consists of a white cylindrical bobbin mounted on a black printed circuit board (PCB). The bobbin is secured to the PCB with three layers of clear adhesive tape. Several electrical leads are visible extending from the PCB.	<p>Secure the bobbin with 3 layers of tape, item [5].</p>
<p>Varnish</p>	 A photograph of the same transformer assembly as in the previous image, but now it is partially submerged in a clear liquid, which is the varnish. The liquid is covering the bottom and sides of the assembly.	<p>Dip the transformer assembly in varnish.</p>

8 Inductor Design Spreadsheet

ACDC_LYTSwitch-5-Buck-Boost_090415; Rev.0.1; Copyright Power Integrations 2015	INPUT	INFO	OUTPUT	UNIT	ACDC_LYTSwitch-5 Buck-Boost Transformer Design Spreadsheet
ENTER APPLICATION VARIABLES					
VACMIN	90		90	V	Minimum AC Input Voltage
VACMAX	308	Info	308	V	Recommend minimum input voltage is 306VAC. Please verify performance on bench
FL			50	Hz	Minimum line frequency
VO_MIN			67.5	V	Guaranteed minimum VO that maintains output regulation
VO	75		75	V	Worst case normal operating output voltage
VO_OVP_MIN			88.4	V	Minimum Voltage at which output voltage protection may be activated
IO	160		160	mA	Average output current specification
n	0.89		0.89	%/100	Total power supply efficiency
Z			0.50		Loss allocation factor
PO			12	W	Total output power
VD			0.70	V	Output diode forward voltage drop
LYTSwitch-5 DESIGN VARIABLES					
Select Breakdown Voltage	725		725	V	Choose between 650V and 725V
Device	LYT52X6		LYT52X6		Chosen LYTSwitch-5 Device
Final device code			LYT5226		
ILIMITMIN			1.77	A	Minimum device current limit
ILIMITTYP			1.90	A	Typical Current Limit
ILIMITMAX			2.03	A	Maximum Current Limit
TON			3.24	us	Expected on-time of MOSFET at low line and PO
FSW			120	kHz	Expected switching frequency at low line and PO
Duty Cycle			38.9	%	Expected operating duty cycle at low line and PO
IRMS			0.31	A	Nominal RMS current through the switch at low line
IPK			1.67	A	Worst Case Peak current
KDP			1.05		Ratio between off-time of switch and reset time of core at VACMIN
ENTER INDUCTOR CORE/CONSTRUCTION VARIABLES					
Core Type	EFD15		EFD15		Core Type
Core Part Number			EFD15-3F3		If custom core is used - Enter part number here
Bobbin part number			-		Bobbin Part number (if available)
AE			15	mm ²	Core Effective Cross Sectional Area
LE			34	mm	Core Effective Path Length
AL			700	nH/T ²	Ungapped Core Effective Inductance
BW			8.85	mm	Bobbin Physical Winding Width
INDUCTOR DESIGN PARAMETERS					
LPMIN			309	uH	Minimum Inductance
LP	325		325	uH	Typical value of Primary Inductance
LP Tolerance	5.00		5	%	Tolerance of Primary Inductance
N	121.00		121	Turns	Number of Turns
ALG			22	nH/T ²	Gapped Core Effective Inductance
BM			2987	Gauss	Operating Flux Density. Maintain value below 3300 G
BP			3826	Gauss	Calculated Worst Case Peak Flux Density (BP < 4200 G)
BAC			1494	Gauss	Worst case AC Flux Density for Core Loss



					Curves (0.5 X Peak to Peak)
LG			0.85	mm	Gap Length (Lg > 0.1 mm)
Layers			4.5		Estimated number of winding layers
IL_RMS			0.52	A	Worst case RMS Current through the inductor
AWG			29	AWG	Primary Wire Gauge (Rounded to next smaller standard AWG value)
CM			128	Cmils	Bare conductor effective area in circular mils
CMA			247	Cmils/A	Primary Winding Current Capacity (200 < CMA < 500)
Current Density (J)			8.08	A/mm ²	Inductor Winding Current density (3.8 < J < 9.75 A/mm ²)
BIAS SECTION					
TURNS_BIAS			22.00	Turns	Number of turns of Bias Winding
VBIAS	13.00		13.00	V	Bias Voltage. Check performance at minimum VO and maximum VAC.
PIVBS			92.20	V	Output Rectifier Maximum Peak Inverse Voltage (calculated at maximum VAC)
CURRENT WAVEFORM SHAPE PARAMETERS					
DMAX			38.94	%	Duty cycle measured at minimum input voltage
I AVG			0.26	A	Input average current measured on the Mosfet at the minimum input voltage
IP			1.21	A	Peak Drain current at minimum input voltage
ISW_RMS			0.31	A	MOSFET RMS current measured at the minimum input voltage
ID_RMS			0.12	A	RMS current of freewheeling diode at minimum input voltage
IL_RMS			0.33	A	RMS current of the of the inductor at the minimum input voltage
FEEDBACK AND BYPASS PIN PARAMETERS					
n_MEASURED			0.89		Measured efficiency (this value is used for resistor calculations only)
VBIAS_MEASURED			13	V	Bias voltage (across the bias capacitor) measured on a prototype unit
VOUT_MEASURED			75	V	Load voltage measured on a prototype unit
RDS_T			1.4775	ohm	Theoretical calculation for RDS sense resistor
RDS			1.47	ohm	Rds resistor calculation assuming E96 / 1%
CDS			10.00	uF	Cds Capacitor Calculation
ROVP			110	k-ohm	OC pin resistor (E96 / 1%)
RL			4.64	M-ohm	L pin resistor (E96 / 1%)
RFB_T			99600.74	ohm	Calculated value of RFB, using standard values for RDS, ROVP, and RL
RFB			100	k-ohm	Feedback pin resistor (E96 / 1%)
CFB_T			60.85	nF	Feedback pin capacitor (for 6ms time constant)
CFB			56	nF	Feedback pin capacitor E12 standard value
RSUP			6.80	k-ohm	Bias supply resistor assuming 1mA current necessary to supply BP
VOLTAGE STRESS PARAMETERS					
VDRAIN			555	V	Estimated worst case drain voltage at VACMAX and VO_MAX
PIVD			577.2	V	Peak Inverse Voltage at VO_MAX on output diode

9 Performance Data

All measurements were taken at room temperature using LED string loads. 1 minute soak time was applied with the AC Source turned-off for 5 seconds for every succeeding input line measurement. All were tested up to 300 VAC input only due to maximum VAC input supply limitation.

9.1 Efficiency

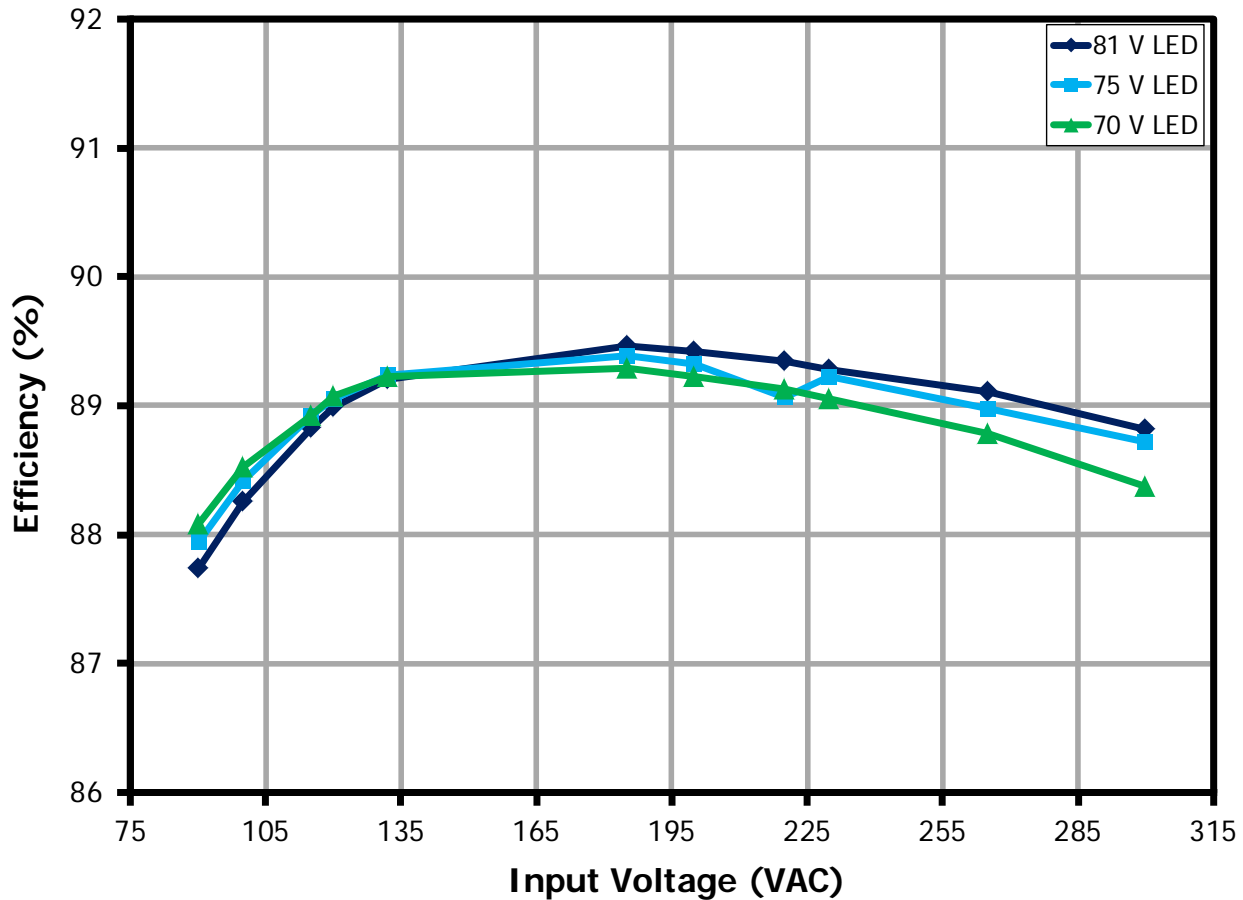

Figure 9 – Efficiency vs. Line and LED Load.

9.2 Line Regulation

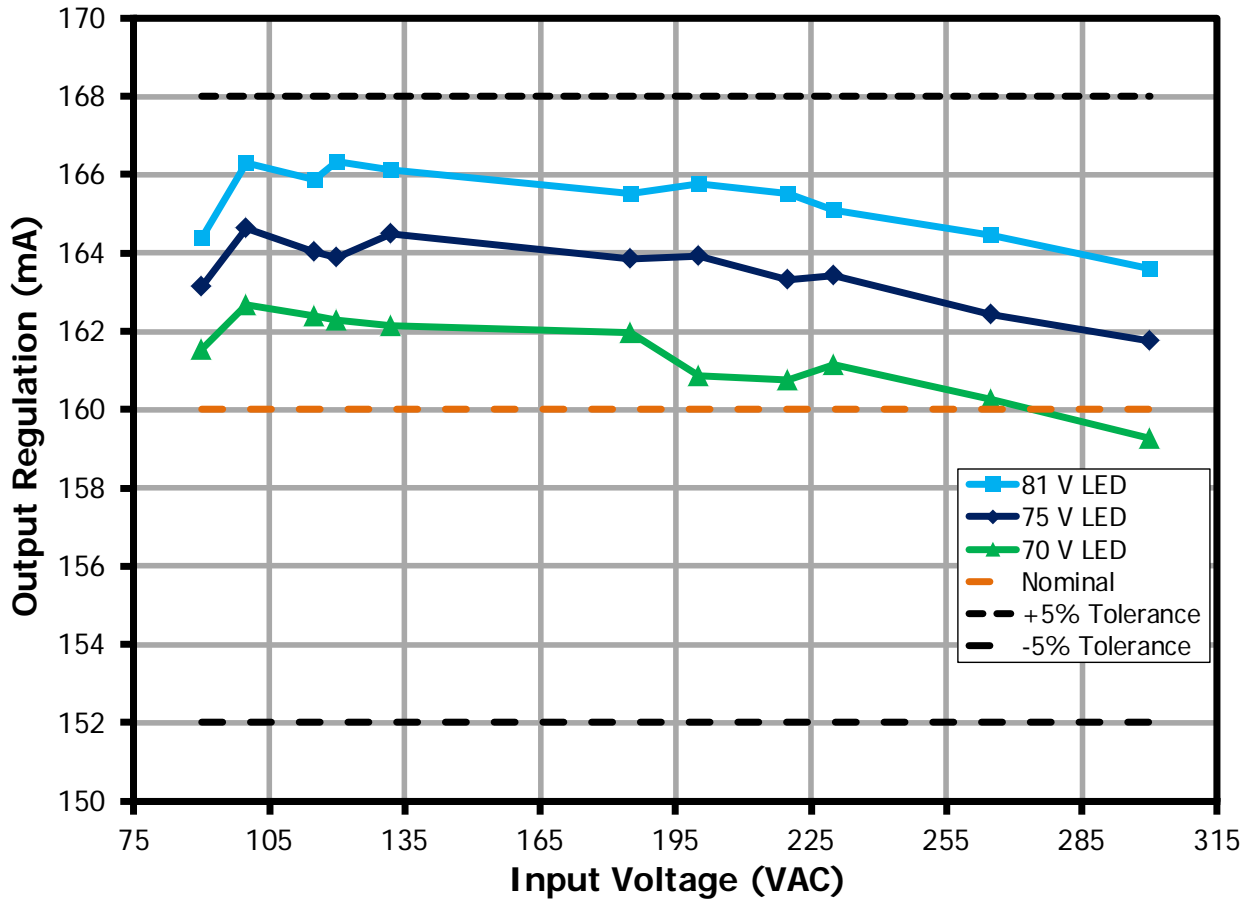

Figure 10 – Regulation vs. Line and LED Load.



9.3 Power Factor

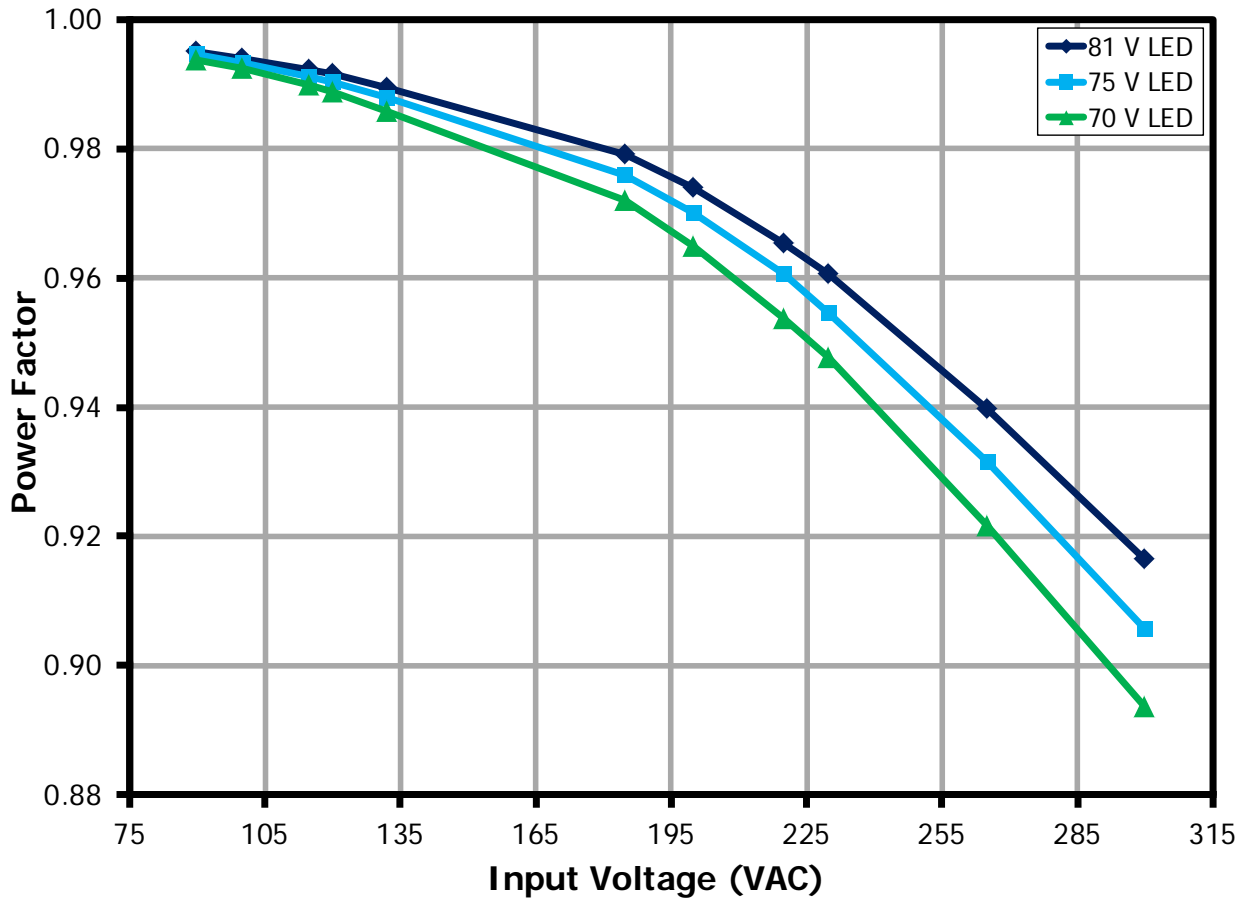

Figure 11 – Power Factor vs. Line and LED Load.

9.4 %ATHD

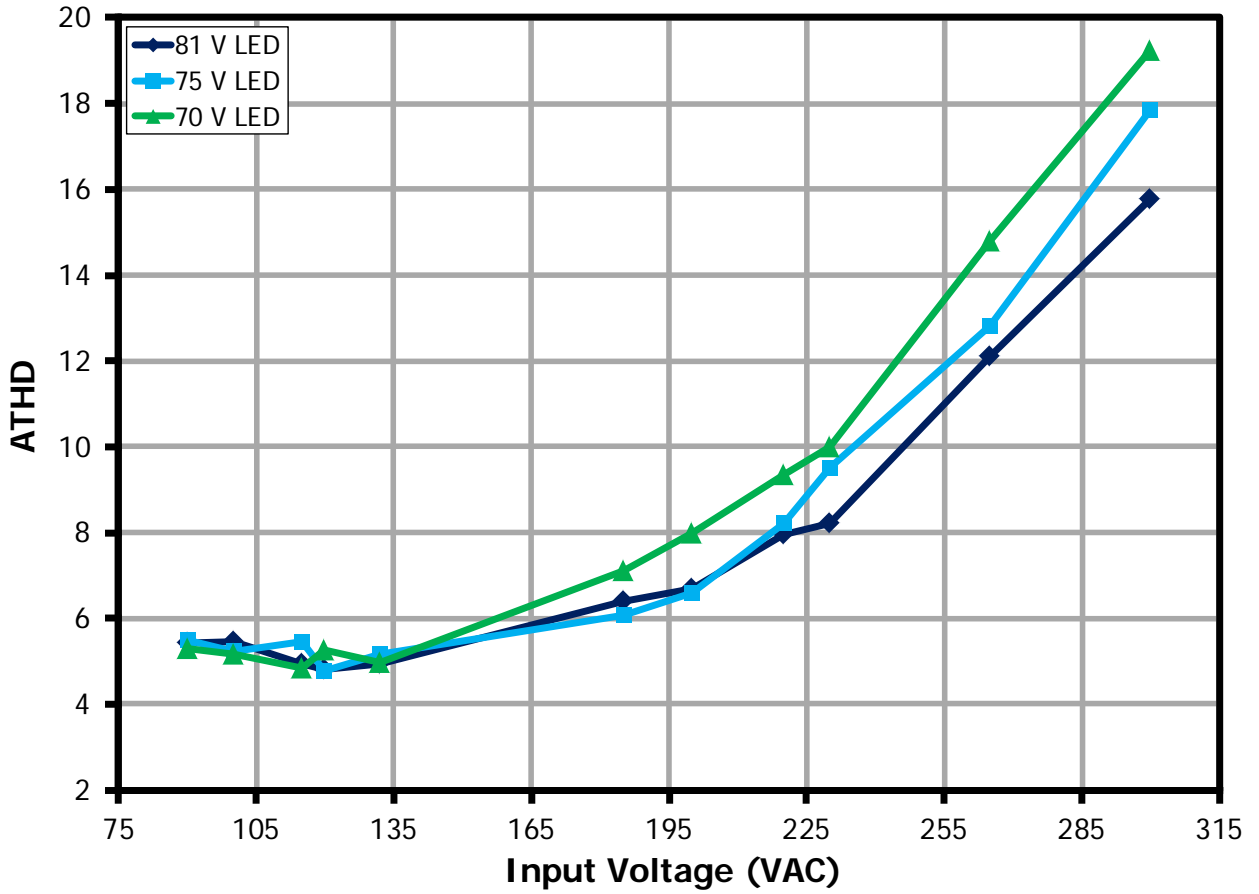

Figure 12 – %ATHD vs. Line and LED Load.



9.5 Harmonics

9.5.1 70 V LED Load

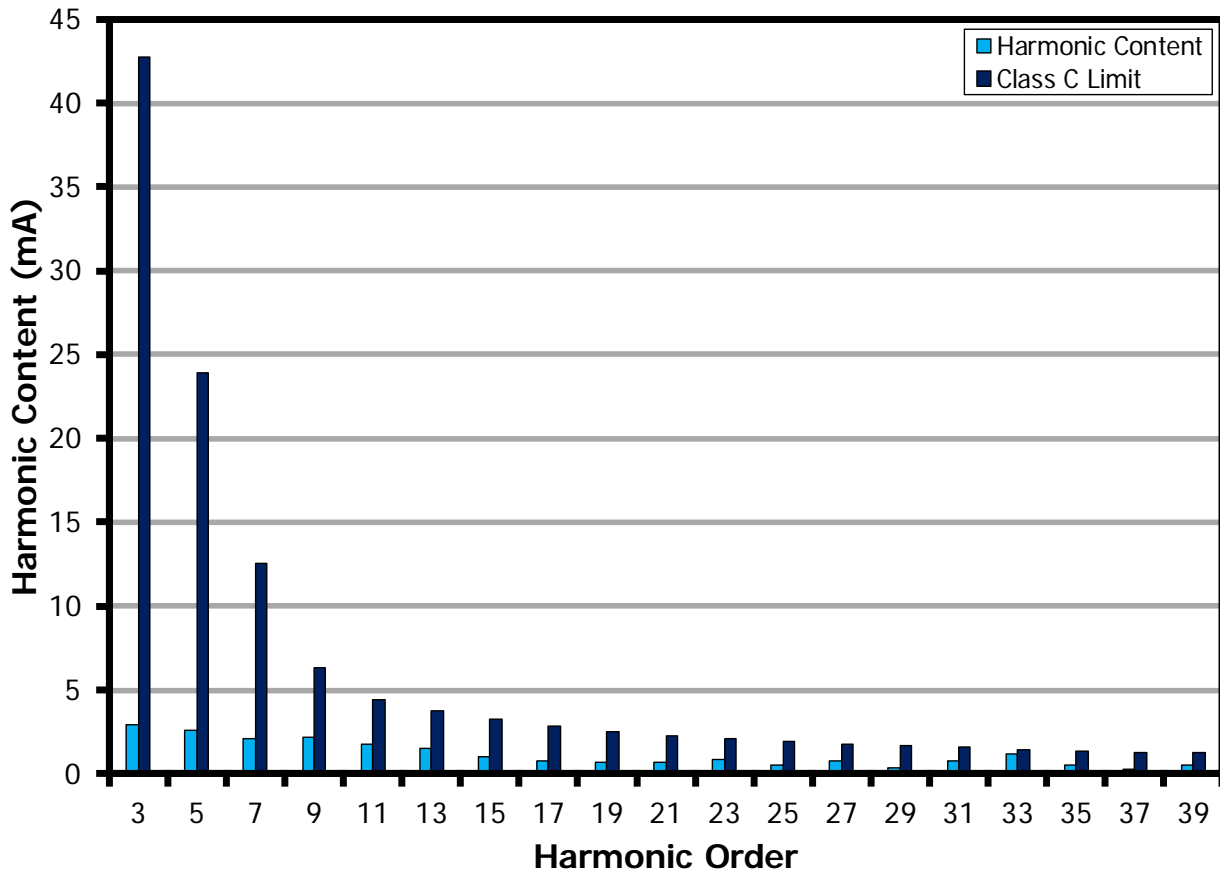

Figure 13 – 70 V LED Load Input Current Harmonics at 230 VAC, 50 Hz.

9.5.2 75 V LED Load

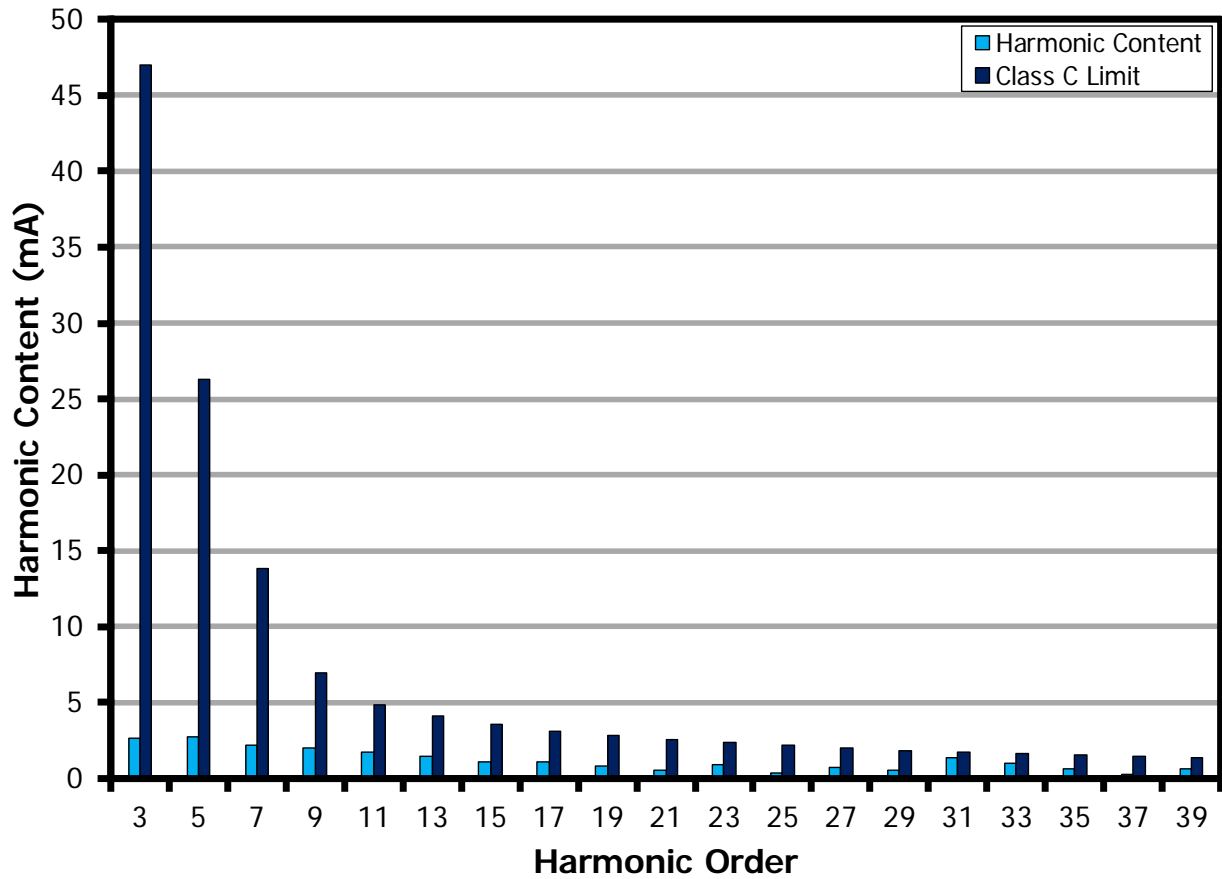

Figure 14 – 75 V LED Load Input Current Harmonics at 230 VAC, 50 Hz.



9.5.3 81 V LED Load

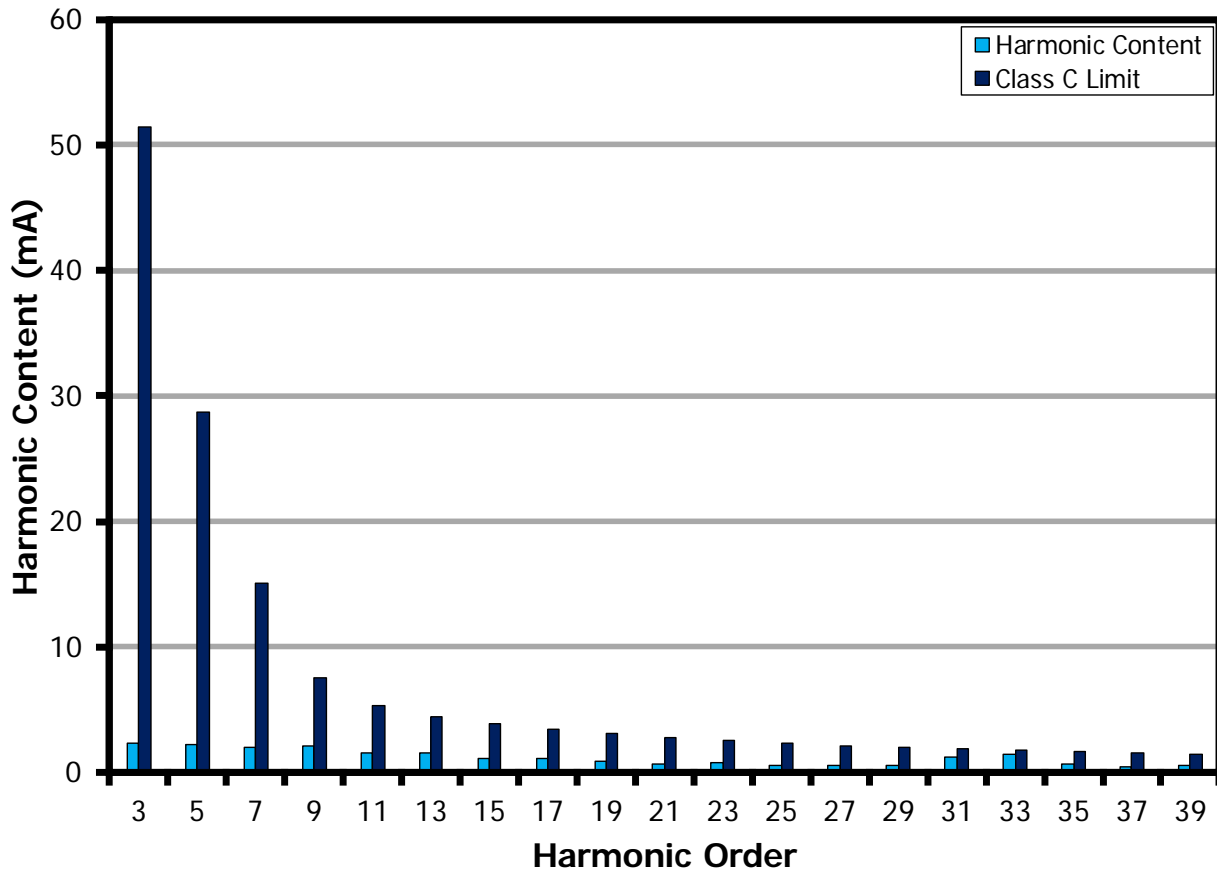

Figure 15 – 81 V LED Load Input Current Harmonics at 230 VAC, 50 Hz.

10 Test Data

10.1 Test Data, 70 V LED Load

Input		Input Measurement					LED Load Measurement			Efficiency (%)
VAC (V _{RMS})	Freq (Hz)	V _{IN} (V _{RMS})	I _{IN} (mA _{RMS})	P _{IN} (W)	PF	%ATHD	V _{OUT} (V _{DC})	I _{OUT} (mA _{DC})	P _{OUT} (W)	
90	60	89.89	145.26	12.98	0.994	5.31	70.26	161.54	11.43	88.08
100	60	99.93	131.24	13.02	0.992	5.18	70.29	162.67	11.52	88.52
115	60	114.93	113.62	12.93	0.990	4.84	70.27	162.40	11.49	88.92
120	60	119.90	108.83	12.90	0.989	5.26	70.31	162.29	11.49	89.08
132	60	131.89	98.97	12.87	0.986	4.97	70.29	162.16	11.48	89.22
185	50	184.93	71.51	12.85	0.972	7.10	70.21	161.98	11.48	89.29
200	50	199.92	66.19	12.77	0.965	7.99	70.18	160.88	11.39	89.23
220	50	219.96	60.89	12.77	0.954	9.35	70.20	160.75	11.38	89.13
230	50	229.99	58.78	12.81	0.948	9.99	70.18	161.15	11.41	89.06
265	50	264.96	52.32	12.78	0.922	14.78	70.18	160.27	11.35	88.79
300	50	300.01	47.56	12.75	0.894	19.23	70.17	159.28	11.27	88.38

10.2 Test Data, 75 V LED Load

Input		Input Measurement					LED Load Measurement			Efficiency (%)
VAC (V _{RMS})	Freq (Hz)	V _{IN} (V _{RMS})	I _{IN} (mA _{RMS})	P _{IN} (W)	PF	%ATHD	V _{OUT} (V _{DC})	I _{OUT} (mA _{DC})	P _{OUT} (W)	
90	60	89.88	88.08	14.19	0.995	5.51	75.99	163.13	12.48	87.94
100	60	99.92	143.52	14.24	0.993	5.25	75.97	164.63	12.59	88.42
115	60	114.92	123.85	14.11	0.991	5.46	75.96	164.04	12.54	88.92
120	60	119.90	118.45	14.06	0.990	4.76	75.92	163.87	12.53	89.06
132	60	131.89	108.18	14.09	0.988	5.16	75.94	164.48	12.58	89.24
185	50	184.92	77.72	14.03	0.976	6.07	75.88	163.85	12.54	89.38
200	50	199.92	72.32	14.03	0.970	6.59	75.80	163.91	12.53	89.32
220	50	219.96	66.31	14.01	0.961	8.23	75.76	163.33	12.48	89.06
230	50	229.98	63.74	13.99	0.955	9.52	75.78	163.41	12.49	89.23
265	50	264.96	56.47	13.94	0.931	12.82	75.74	162.41	12.40	88.98
300	50	300.01	51.19	13.91	0.906	17.84	75.71	161.74	12.34	88.72

10.3 Test Data, 81 V LED Load

Input		Input Measurement					LED Load Measurement			Efficiency (%)
VAC (V _{RMS})	Freq (Hz)	V _{IN} (V _{RMS})	I _{IN} (mA _{RMS})	P _{IN} (W)	PF	%ATHD	V _{OUT} (V _{DC})	I _{OUT} (mA _{DC})	P _{OUT} (W)	
90	60	89.87	172.38	15.42	0.995	5.42	81.78	164.38	13.52	87.73
100	60	99.91	156.16	15.51	0.994	5.45	81.78	166.30	13.69	88.26
115	60	114.91	134.67	15.36	0.992	4.93	81.75	165.86	13.64	88.83
120	60	119.89	129.26	15.37	0.992	4.80	81.69	166.35	13.67	88.99
132	60	131.88	117.23	15.30	0.989	4.93	81.62	166.13	13.64	89.21
185	50	184.91	83.93	15.20	0.979	6.39	81.51	165.52	13.59	89.46
200	50	199.91	78.21	15.23	0.974	6.69	81.51	165.78	13.62	89.42
220	50	219.95	71.65	15.22	0.965	7.96	81.50	165.51	13.59	89.35
230	50	229.98	68.74	15.18	0.961	8.23	81.49	165.09	13.56	89.28
265	50	264.95	60.80	15.14	0.940	12.10	81.42	164.45	13.49	89.11
300	50	300.00	54.94	15.11	0.917	15.75	81.42	163.59	13.42	88.82

10.4 Test Data, Harmonic Content at 230 VAC with 70 V LED Load

V _{IN} (V _{RMS})	Freq	I _{IN} (mA _{RMS})	P _{IN} (W)	%THD	
230	50	25.08	5.030		
nth Order	mA Content	% Content	mA Limit <25 W	% Limit >25 W	Remarks
1	56.69				
2	0.17	0.30%		2.00%	
3	2.89	5.10%	42.77	28.10%	Pass
5	2.64	4.66%	23.90	10.00%	Pass
7	2.13	3.76%	12.58	7.00%	Pass
9	2.16	3.81%	6.29	5.00%	Pass
11	1.74	3.07%	4.40	3.00%	Pass
13	1.49	2.63%	3.73	3.00%	Pass
15	1.02	1.80%	3.23	3.00%	Pass
17	0.76	1.34%	2.85	3.00%	Pass
19	0.69	1.22%	2.55	3.00%	Pass
21	0.73	1.29%	2.31	3.00%	Pass
23	0.88	1.55%	2.11	3.00%	Pass
25	0.53	0.93%	1.94	3.00%	Pass
27	0.80	1.41%	1.79	3.00%	Pass
29	0.34	0.60%	1.67	3.00%	Pass
31	0.77	1.36%	1.56	3.00%	Pass
33	1.17	2.06%	1.47	3.00%	Pass
35	0.53	0.93%	1.38	3.00%	Pass
37	0.29	0.51%	1.31	3.00%	Pass
39	0.50	0.88%	1.24	3.00%	Pass

10.5 Test Data, Harmonic Content at 230 VAC with 75 V LED Load

V_{IN} (V_{RMS})	Freq	I_{IN} (mA_{RMS})	P_{IN} (W)	%THD	
230	50	26.94	5.495		
nth Order	mA Content	% Content	mA Limit <25 W	% Limit >25 W	Remarks
1	62.03				
2	0.06	0.10%		2.00%	
3	2.67	4.30%	46.99	28.37%	Pass
5	2.70	4.35%	26.26	10.00%	Pass
7	2.20	3.55%	13.82	7.00%	Pass
9	1.97	3.18%	6.91	5.00%	Pass
11	1.69	2.72%	4.84	3.00%	Pass
13	1.48	2.39%	4.09	3.00%	Pass
15	1.08	1.74%	3.55	3.00%	Pass
17	1.03	1.66%	3.13	3.00%	Pass
19	0.81	1.31%	2.80	3.00%	Pass
21	0.54	0.87%	2.53	3.00%	Pass
23	0.85	1.37%	2.31	3.00%	Pass
25	0.38	0.61%	2.13	3.00%	Pass
27	0.74	1.19%	1.97	3.00%	Pass
29	0.49	0.79%	1.83	3.00%	Pass
31	1.39	2.24%	1.72	3.00%	Pass
33	0.98	1.58%	1.61	3.00%	Pass
35	0.59	0.95%	1.52	3.00%	Pass
37	0.25	0.40%	1.44	3.00%	Pass
39	0.59	0.95%	1.36	3.00%	Pass

10.6 Test Data, Harmonic Content at 230 VAC with 81 V LED Load

V_{IN} (V_{RMS})	Freq	I_{IN} (mA_{RMS})	P_{IN} (W)	%THD	
230	50	28.80	5.960		
nth Order	mA Content	% Content	mA Limit <25 W	% Limit >25 W	Remarks
1	67.56				
2	0.13	0.19%		2.00%	
3	2.32	3.43%	51.44	28.60%	Pass
5	2.27	3.36%	28.75	10.00%	Pass
7	2.05	3.03%	15.13	7.00%	Pass
9	2.14	3.17%	7.57	5.00%	Pass
11	1.53	2.26%	5.30	3.00%	Pass
13	1.50	2.22%	4.48	3.00%	Pass
15	1.08	1.60%	3.88	3.00%	Pass
17	1.06	1.57%	3.43	3.00%	Pass
19	0.93	1.38%	3.07	3.00%	Pass
21	0.66	0.98%	2.77	3.00%	Pass
23	0.76	1.12%	2.53	3.00%	Pass
25	0.58	0.86%	2.33	3.00%	Pass
27	0.59	0.87%	2.16	3.00%	Pass
29	0.53	0.78%	2.01	3.00%	Pass
31	1.17	1.73%	1.88	3.00%	Pass
33	1.44	2.13%	1.77	3.00%	Pass
35	0.64	0.95%	1.66	3.00%	Pass
37	0.39	0.58%	1.57	3.00%	Pass
39	0.51	0.75%	1.49	3.00%	Pass

11 Thermal Performance at 25 °C

Thermal measurements were performed with the power supply operating at 25 °C room ambient temperature with a 75 V LED load.

11.1 Thermal Performance at 120 VAC

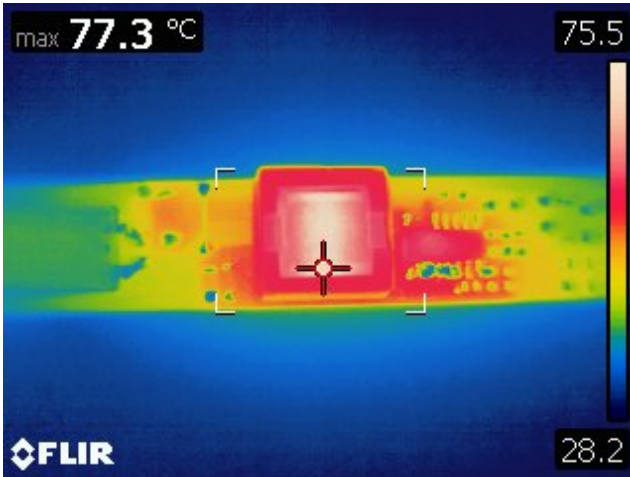

Figure 16 – 120 VAC, 75 V LED Load.
Spot 1: Transformer (T1): 77.3 °C.

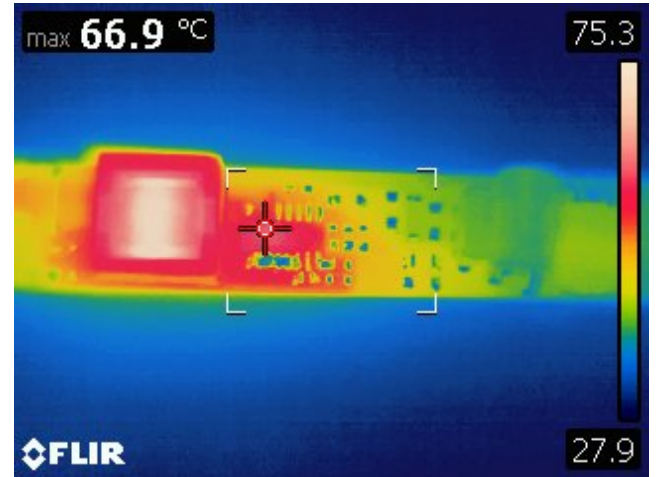

Figure 17 – 120 VAC, 75 V LED Load.
Spot 1: LYT5226D (U1): 66.9 °C.

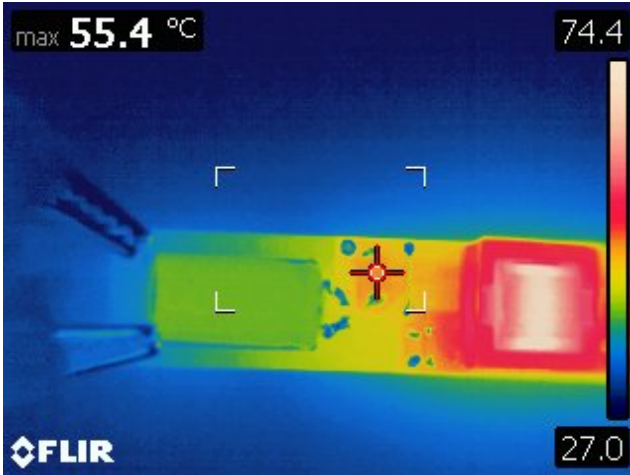

Figure 18 – 120 VAC, 75 V LED Load.
Spot 1: Output Rectifier (D7): 55.4 °C.

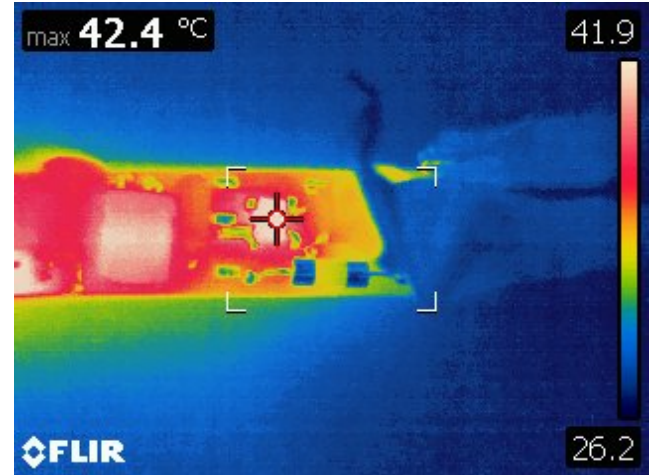

Figure 19 – 120 VAC, 75 V LED Load.
Spot 1: Bridge Rectifier (BR1): 42.4 °C.

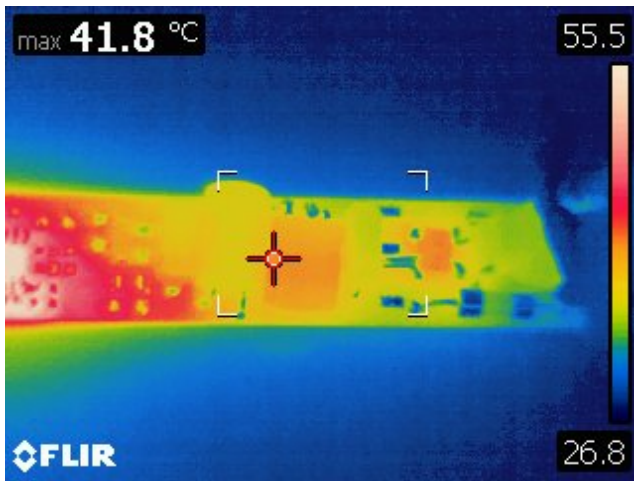

Figure 20 – 120 VAC, 75 V LED Load.
Spot 1: Input Filter Choke (L1): 41.8 °C.

11.2 Thermal Performance at 230 VAC

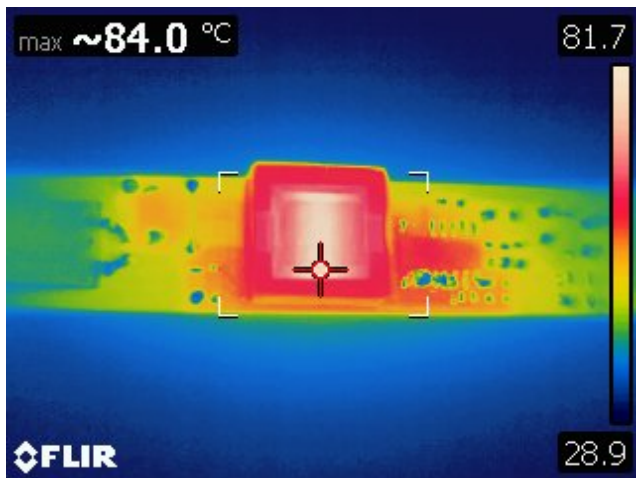

Figure 21 – 230 VAC, 75V LED Load.
Spot 1: Transformer (T1): 84 °C.

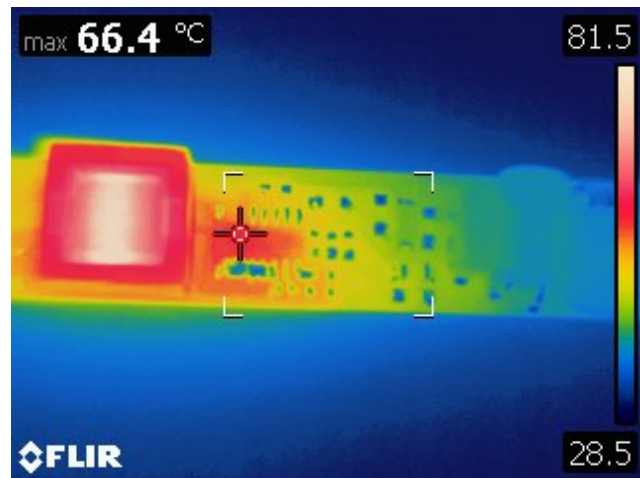

Figure 22 – 230 VAC, 75V LED Load.
Spot 1: LYT5226D (U1): 66.4 °C.

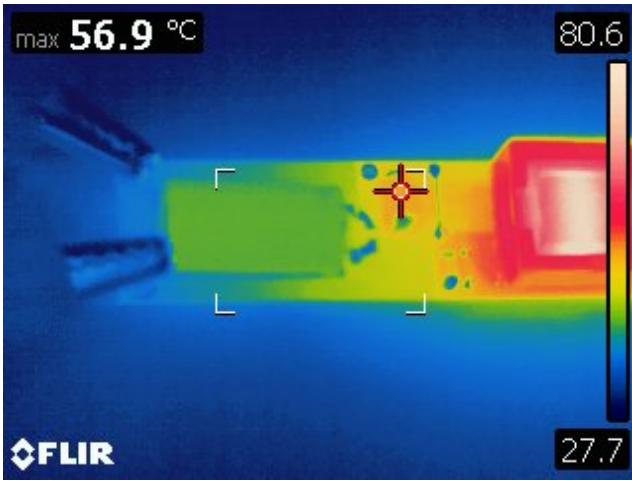

Figure 23 – 230 VAC, 75V LED Load.
Spot 1: Output Rectifier (D7): 56.9 °C.

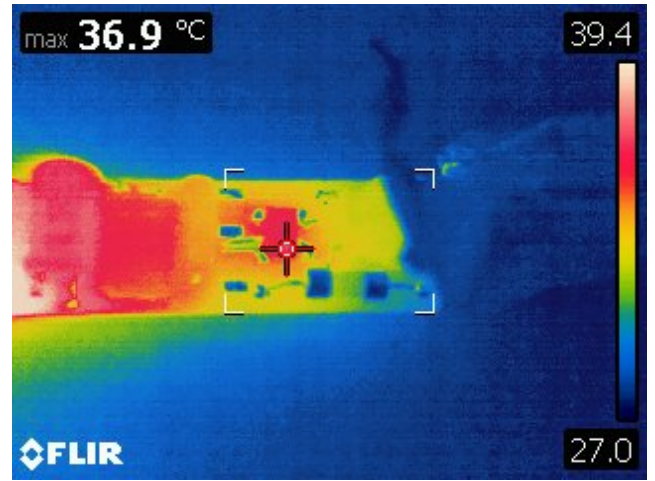

Figure 24 – 230 VAC, 75V LED Load.
Spot 1: Bridge Rectifier (BR1): 36.9 °C.

12 Thermal Performance at 100 °C

Thermal measurements were performed with the power supply operating inside the thermal chamber at 100 °C ambient temperature with a 75 V LED load.

12.1 Set-up

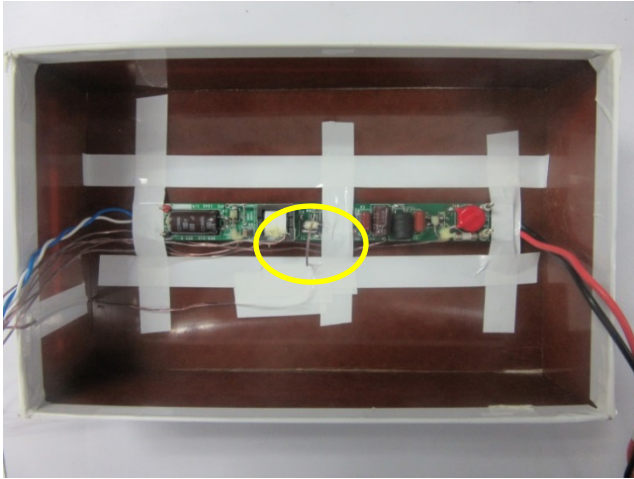

Figure 25 – Set-up, the board is placed inside a 5 x 8 x 2 inches box as shown. Thermocouple wire for the ambient temperature was placed directly above the LYTSwitch-5 IC.

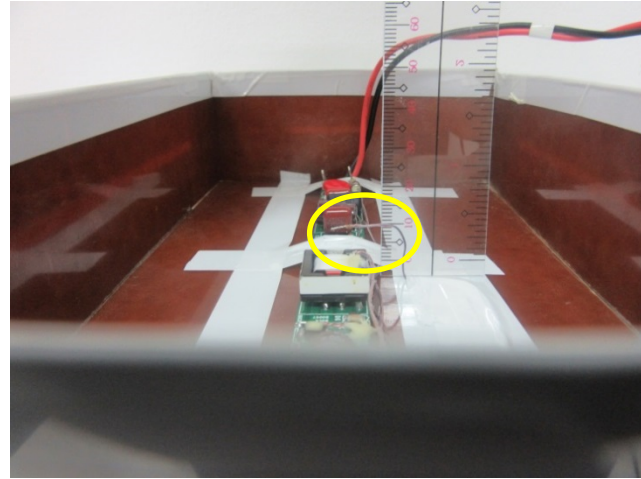

Figure 26 – Set-up, the thermocouple wire measuring the ambient temperature inside the box is placed about 10mm from the board above the LYTSwitch-5 IC.

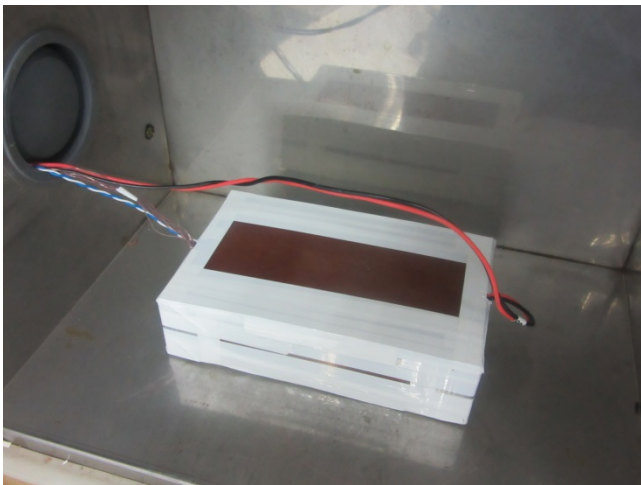

Figure 27 – Set-up, the box was fully sealed and placed inside the thermal chamber as shown.

12.2 Thermal Performance with Respect to the Line Voltage

Thermal Measurement (°C)	Ambient Temperature (°C)	LYTSwitch-5 (°C)	Transformer (°C)	BR1 (°C)	D7 (°C)	C8 (°C)
90 VAC	100	128.8	127.5	107.4	114.9	103.5
120 VAC	100	126.2	129.8	105.4	116.1	104.2
230 VAC	100	125.4	132.9	102.3	117.3	107.6
300 VAC	100	126.5	132.6	101.5	117.6	107.6



12.3 Output Current Regulation at 120 VAC Input

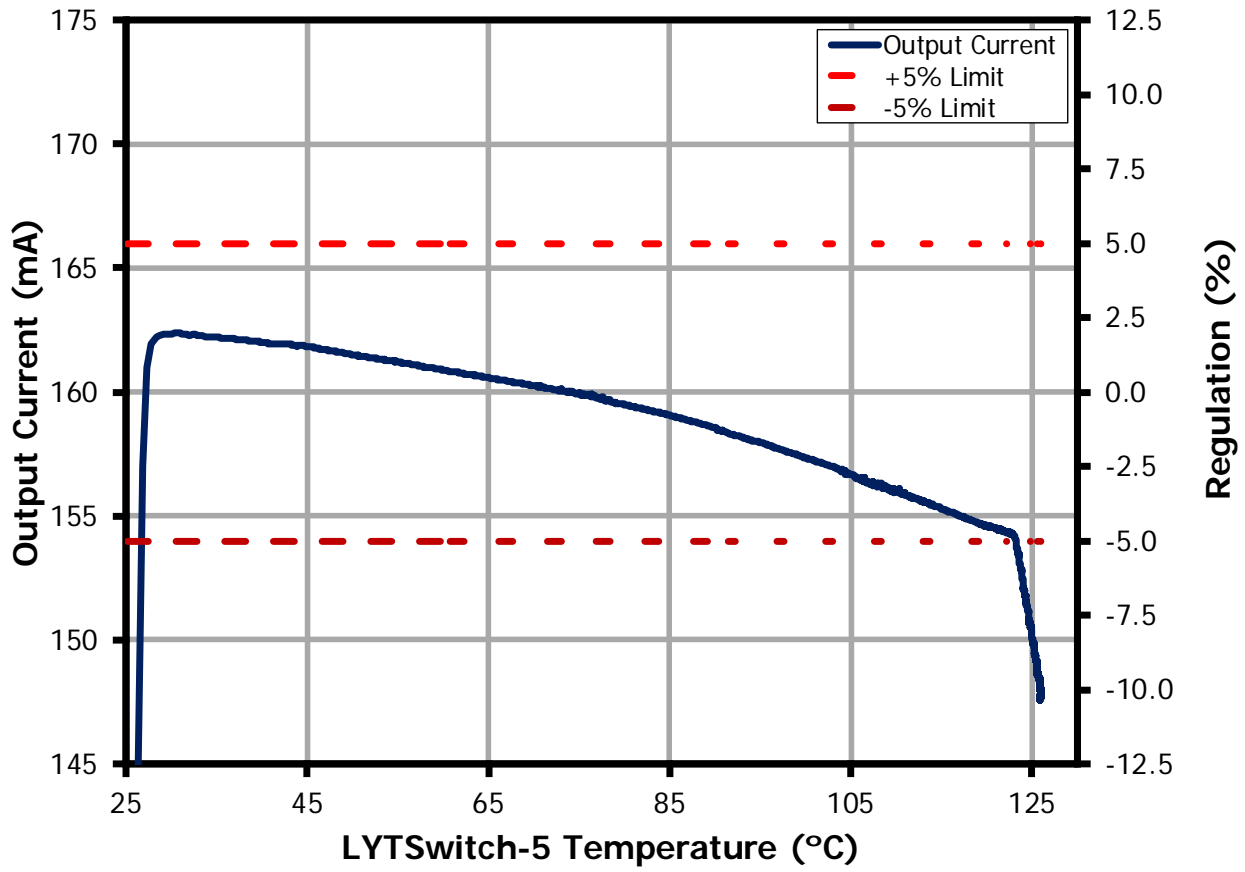

Figure 28 – Output Current Regulation at 120 VAC Input.

12.4 Output Current Regulation at 230 VAC Input

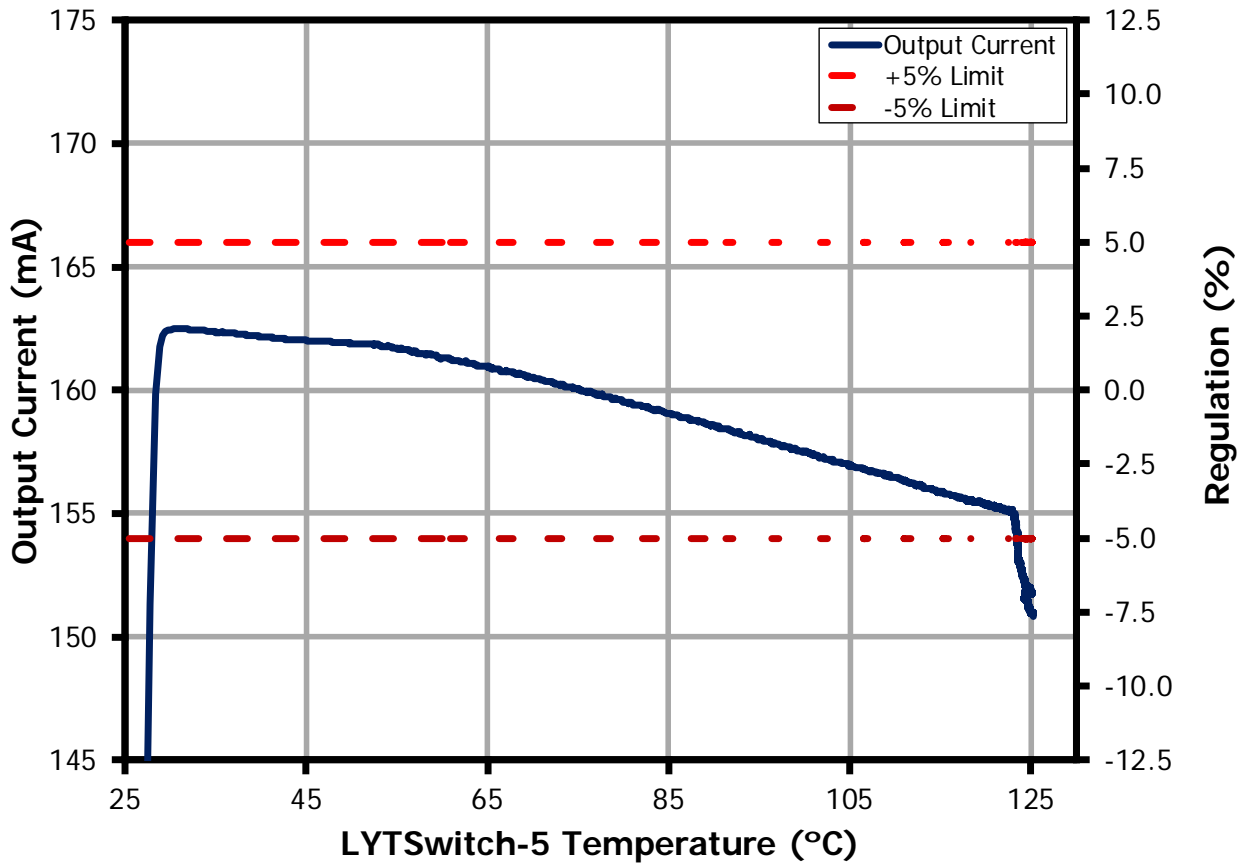

Figure 29 – Output Current Regulation at 230 VAC Input.



13 Waveforms

All were tested up to 300 VAC input only due to maximum VAC input supply limitation.

13.1 Input Voltage and Input Current Waveforms

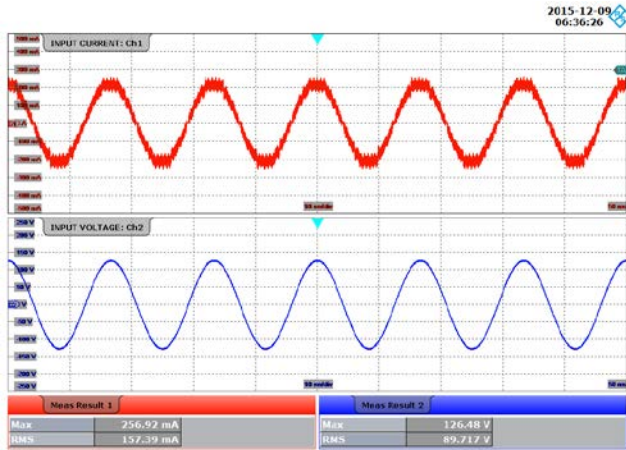

Figure 30 – 90 VAC, 75 V LED Load.
Upper: I_{IN} , 100 mA / div.
Lower: V_{IN} , 50 V / div., 10 ms / div.

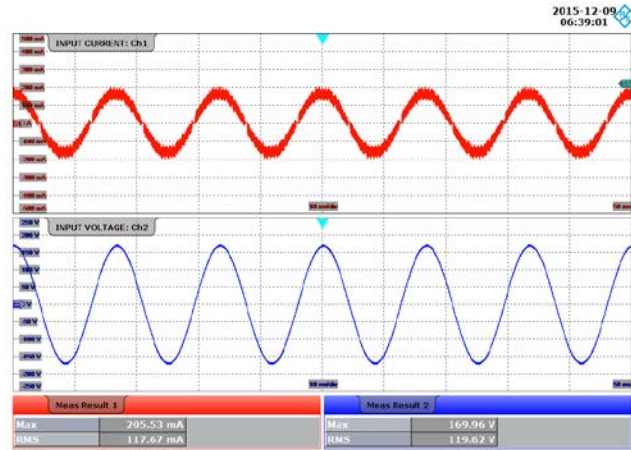

Figure 31 – 120 VAC, 75 V LED Load.
Upper: I_{IN} , 100 mA / div.
Lower: V_{IN} , 50 V / div., 10 ms / div.

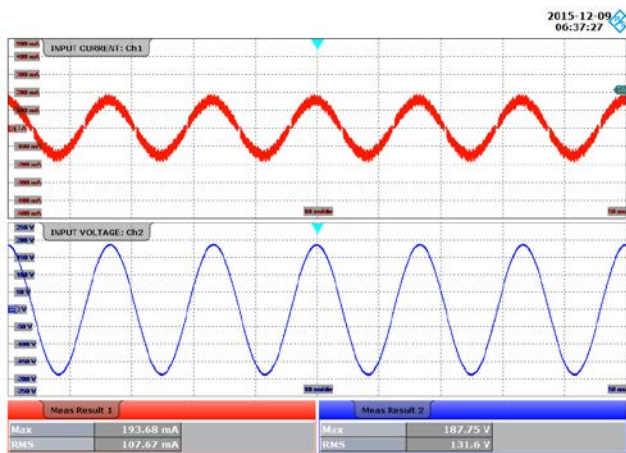

Figure 32 – 132 VAC, 75 V LED Load.
Upper: I_{IN} , 100 mA / div.
Lower: V_{IN} , 50 V / div., 10 ms / div.

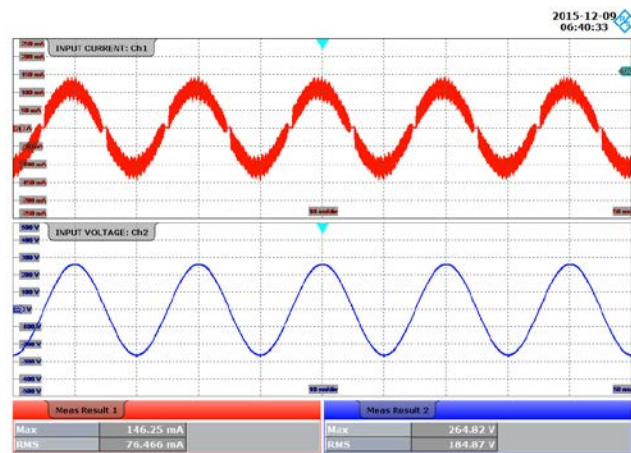

Figure 33 – 185 VAC, 75 V LED Load.
Upper: I_{IN} , 50 mA / div.
Lower: V_{IN} , 100 V / div., 10 ms / div.

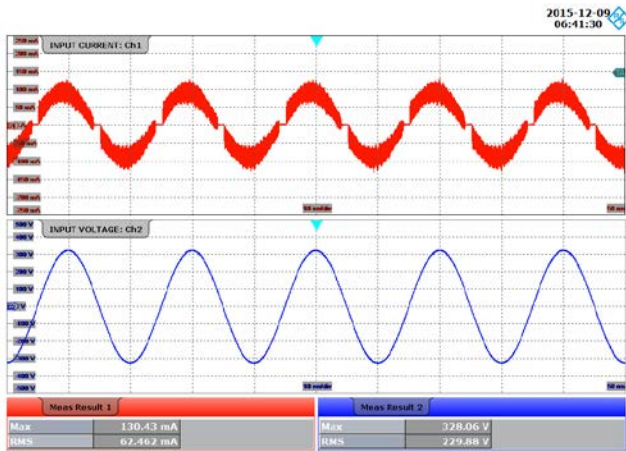

Figure 34 – 230 VAC, 75 V LED Load.
 Upper: I_{IN} , 50 mA / div.
 Lower: V_{IN} , 100 V / div., 10 ms / div.

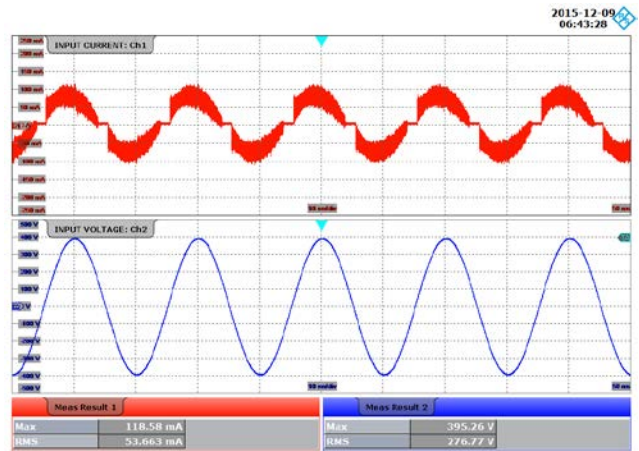

Figure 35 – 277 VAC, 75 V LED Load.
 Upper: I_{IN} , 50 mA / div.
 Lower: V_{IN} , 100 V / div., 10 ms / div.

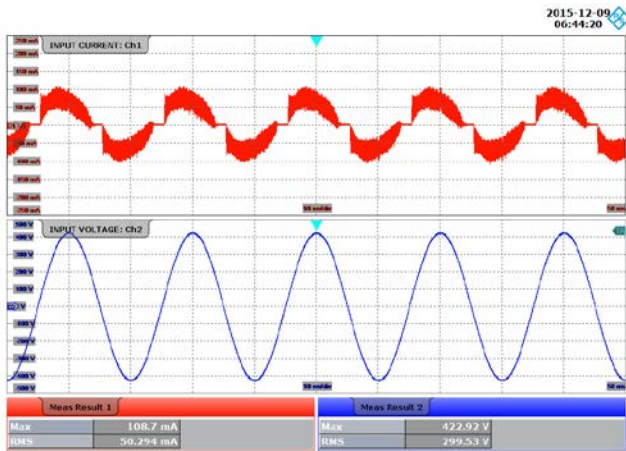

Figure 36 – 300 VAC, 75 V LED Load.
 Upper: I_{IN} , 50 mA / div.
 Lower: V_{IN} , 100 V / div., 10 ms / div.

13.2 Output Current Rise and Fall

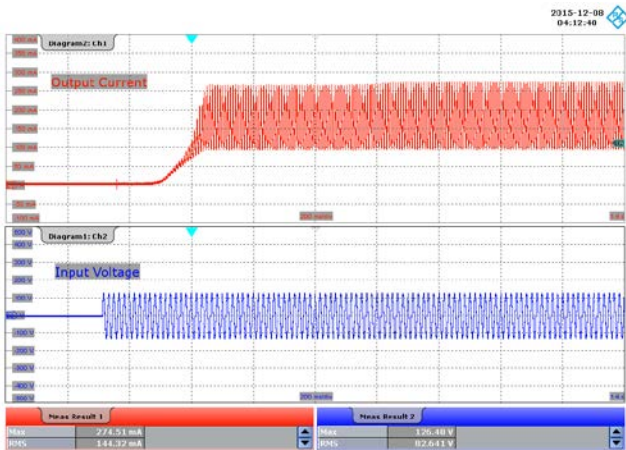

Figure 37 – 90 VAC, 75 V LED Load, Output Rise.
 Upper: I_{OUT} , 50 mA / div.
 Lower: V_{IN} , 100 V / div., 200 ms / div.

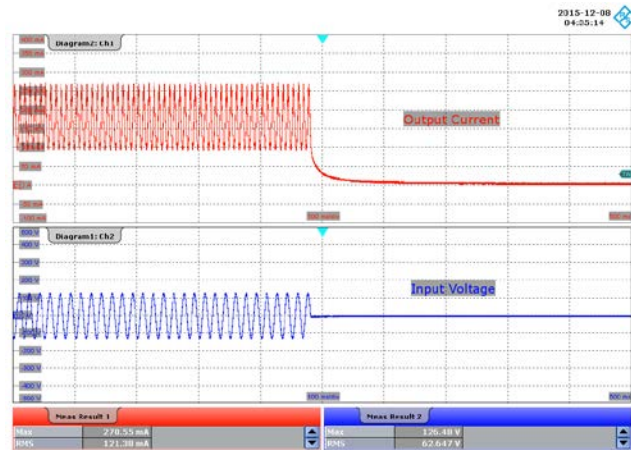

Figure 38 – 90 VAC, 75 V LED Load, Output Fall.
 Upper: I_{OUT} , 50 mA / div.
 Lower: V_{IN} , 100 V / div., 100 ms / div.

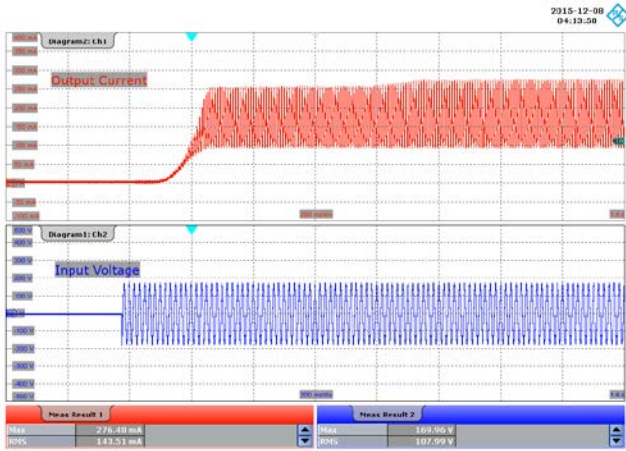

Figure 39 – 120 VAC, 75 V LED Load, Output Rise.
 Upper: I_{OUT} , 50 mA / div.
 Lower: V_{IN} , 100 V / div., 200 ms / div.

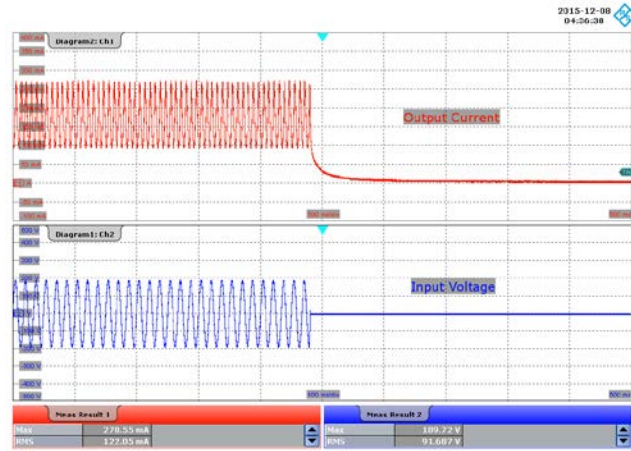

Figure 40 – 120 VAC, 75 V LED Load, Output Fall.
 Upper: I_{OUT} , 50 mA / div.
 Lower: V_{IN} , 100 V / div., 100 ms / div.

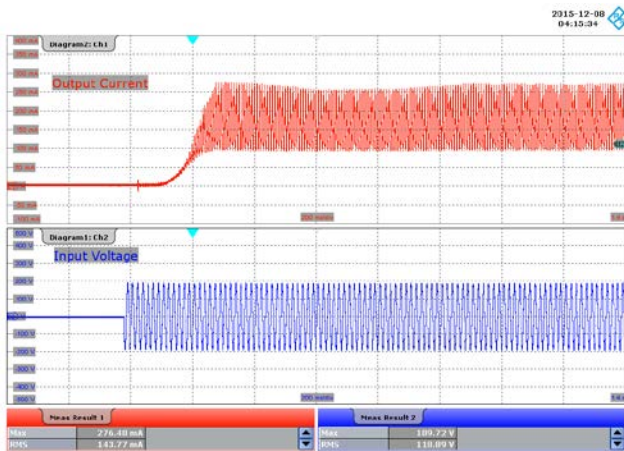

Figure 41 – 132 VAC, 75 V LED Load, Output Rise.
 Upper: I_{OUT} , 50 mA / div.
 Lower: V_{IN} , 100 V / div., 200 ms / div.

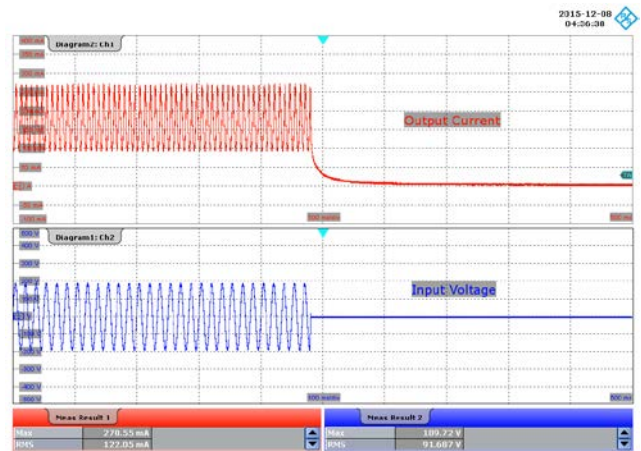

Figure 42 – 132 VAC, 75 V LED Load, Output Fall.
 Upper: I_{OUT} , 50 mA / div.
 Lower: V_{IN} , 100 V / div., 100 ms / div.

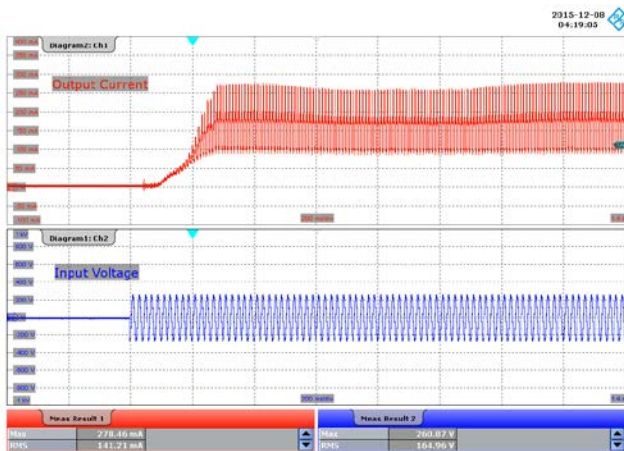

Figure 43 – 185 VAC, 75 V LED Load, Output Rise.
 Upper: I_{OUT} , 50 mA / div.
 Lower: V_{IN} , 200 V / div., 200 ms / div.

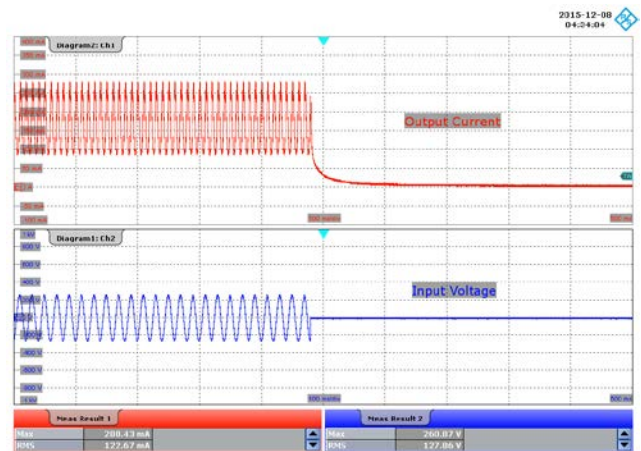

Figure 44 – 185 VAC, 75 V LED Load, Output Fall.
 Upper: I_{OUT} , 50 mA / div.
 Lower: V_{IN} , 200 V / div., 100 ms / div.



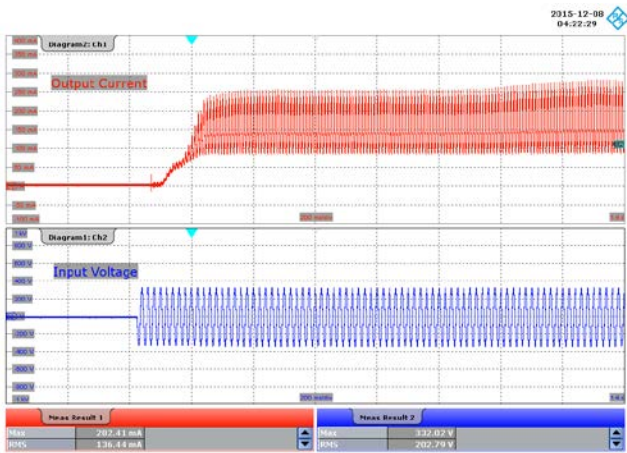

Figure 45 – 230 VAC, 75 V LED Load, Output Rise.
 Upper: I_{OUT} , 50 mA / div.
 Lower: V_{IN} , 200 V / div., 200 ms / div.

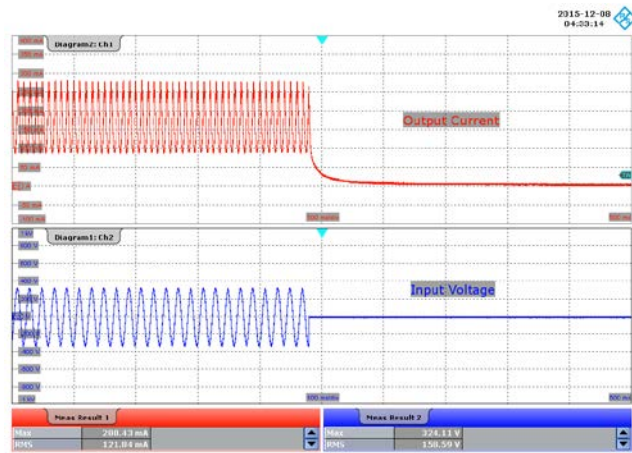

Figure 46 – 230 VAC, 75 V LED Load, Output Fall.
 Upper: I_{OUT} , 50 mA / div.
 Lower: V_{IN} , 200 V / div., 100 ms / div.

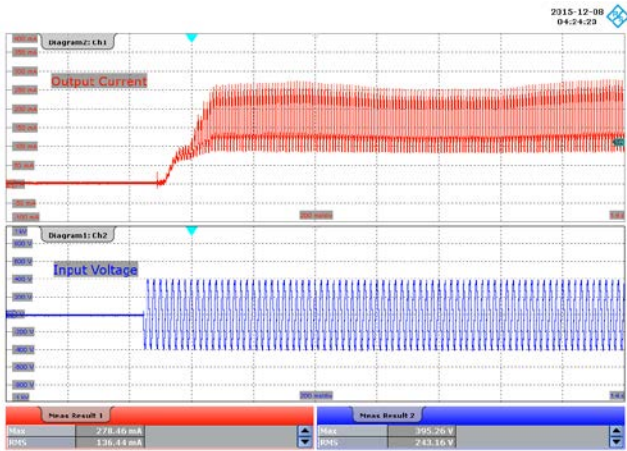

Figure 47 – 277 VAC, 75 V LED Load, Output Rise.
 Upper: I_{OUT} , 50 mA / div.
 Lower: V_{IN} , 200 V / div., 200 ms / div.

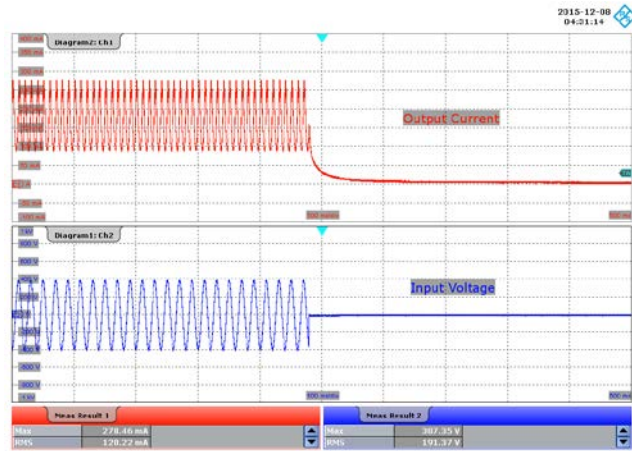

Figure 48 – 277 VAC, 75 V LED Load, Output Fall.
 Upper: I_{OUT} , 50 mA / div.
 Lower: V_{IN} , 200 V / div., 100 ms / div.

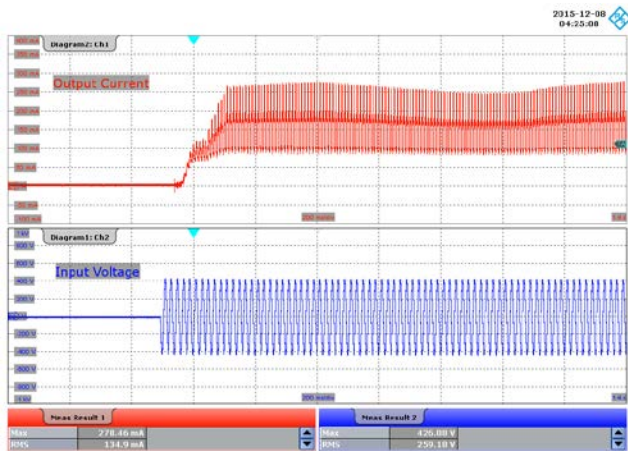

Figure 49 – 300 VAC, 75 V LED Load, Output Rise.
 Upper: I_{OUT} , 50 mA / div.
 Lower: V_{IN} , 200 V / div., 200 ms / div.

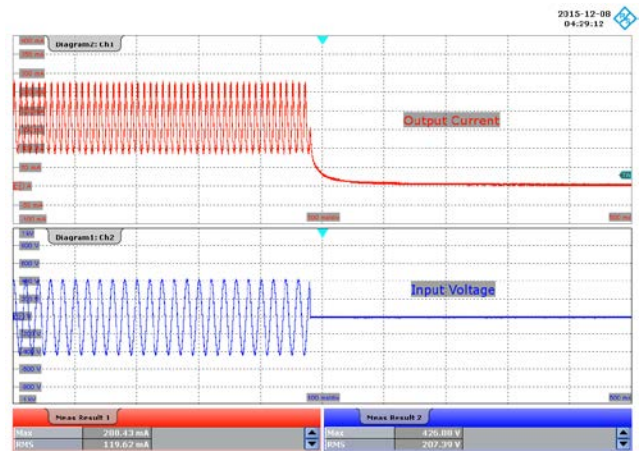

Figure 50 – 300 VAC, 75 V LED Load, Output Fall.
 Upper: I_{OUT} , 50 mA / div.
 Lower: V_{IN} , 200 V / div., 100 ms / div.

13.3 Drain Voltage and Current in Normal Operation

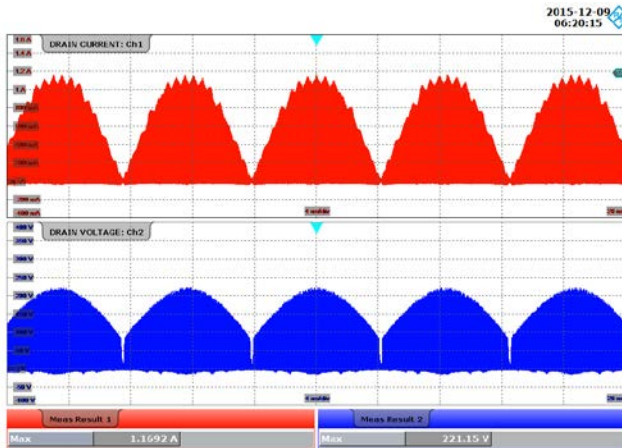

Figure 51 – 90 VAC, 75 V LED Load.
 Upper: I_{DRAIN} , 200 mA / div.
 Lower: V_{DRAIN} , 50 V / div., 4 ms / div.

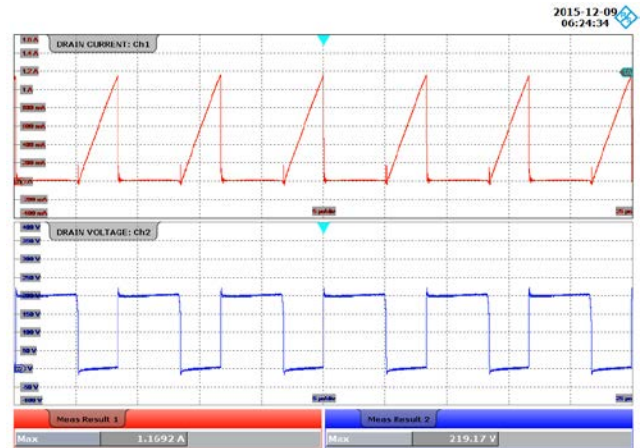

Figure 52 – 90 VAC, 75 V LED Load.
 Upper: I_{DRAIN} , 200 mA / div.
 Lower: V_{DRAIN} , 50 V / div., 5 μ s / div.

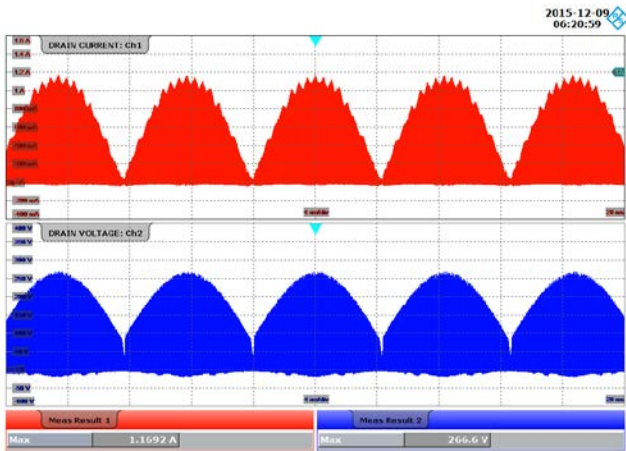

Figure 53 – 120 VAC, 75 V LED Load.
 Upper: I_{DRAIN} , 200 mA / div.
 Lower: V_{DRAIN} , 50 V / div., 4 ms / div.

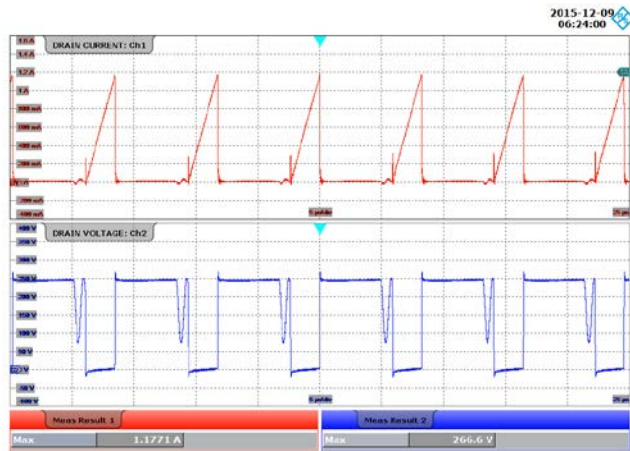

Figure 54 – 120 VAC, 75 V LED Load.
 Upper: I_{DRAIN} , 200 mA / div.
 Lower: V_{DRAIN} , 50 V / div., 5 μ s / div.

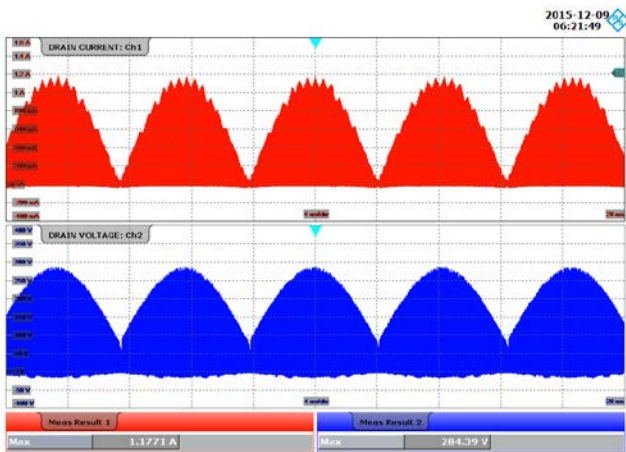

Figure 55 – 132 VAC, 75 V LED Load.
 Upper: I_{DRAIN} , 200 mA / div.
 Lower: V_{DRAIN} , 50 V / div., 4 ms / div.

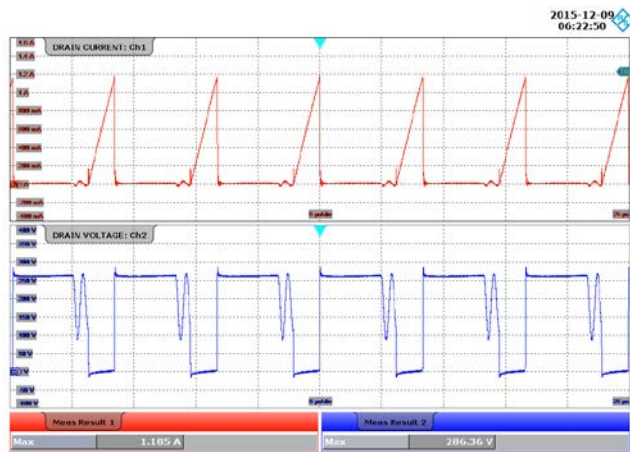

Figure 56 – 132 VAC, 75 V LED Load.
 Upper: I_{DRAIN} , 200 mA / div.
 Lower: V_{DRAIN} , 50 V / div., 5 μ s / div.

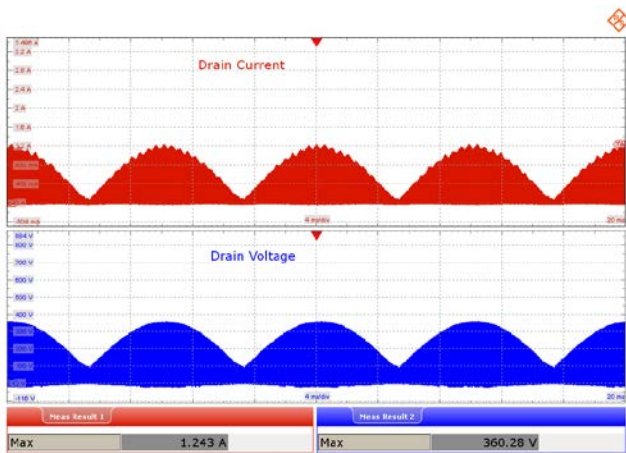

Figure 57 – 185 VAC, 75 V LED Load.
 Upper: I_{DRAIN} , 400 mA / div.
 Lower: V_{DRAIN} , 100 V / div., 4 ms / div.

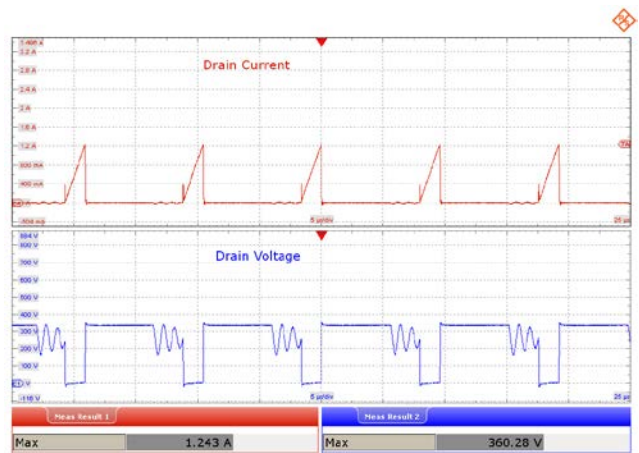

Figure 58 – 185 VAC, 75 V LED Load.
 Upper: I_{DRAIN} , 400 mA / div.
 Lower: V_{DRAIN} , 100 V / div., 5 μ s / div.

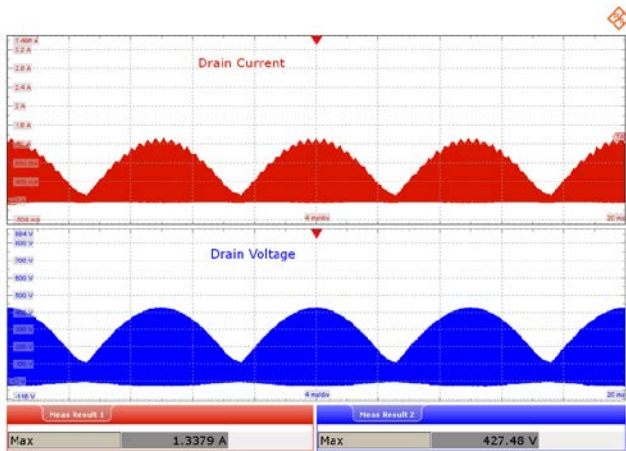

Figure 59 – 230 VAC, 75 V LED Load.
 Upper: I_{DRAIN} , 400 mA / div.
 Lower: V_{DRAIN} , 100 V / div., 4 ms / div.

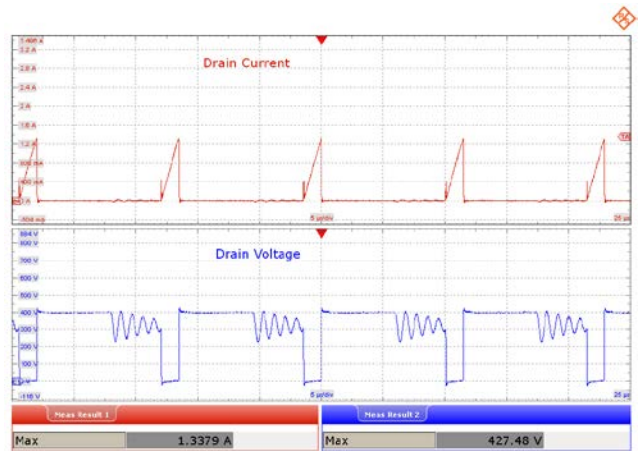

Figure 60 – 230 VAC, 75 V LED Load.
 Upper: I_{DRAIN} , 400 mA / div.
 Lower: V_{DRAIN} , 100 V / div., 5 μ s / div.

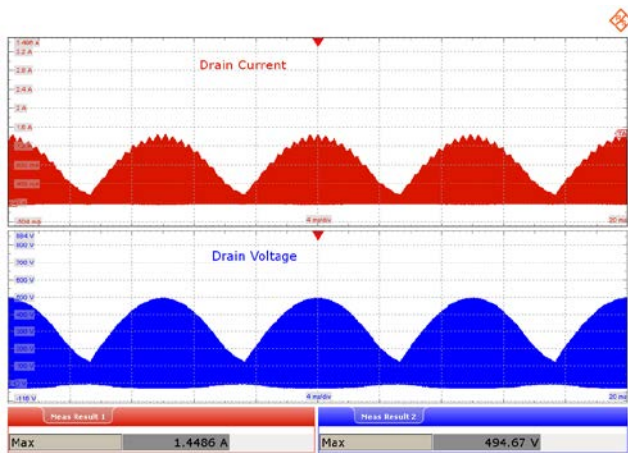

Figure 61 – 277 VAC, 75 V LED Load.
 Upper: I_{DRAIN} , 400 mA / div.
 Lower: V_{DRAIN} , 100 V / div., 4 ms / div.

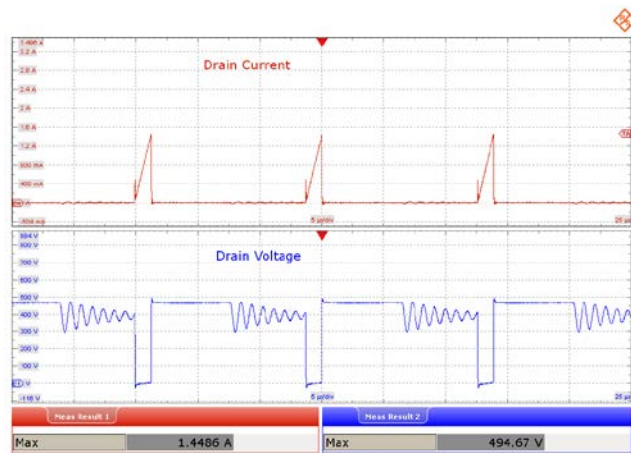

Figure 62 – 277 VAC, 75 V LED Load.
 Upper: I_{DRAIN} , 400 mA / div.
 Lower: V_{DRAIN} , 100 V / div., 5 μ s / div.

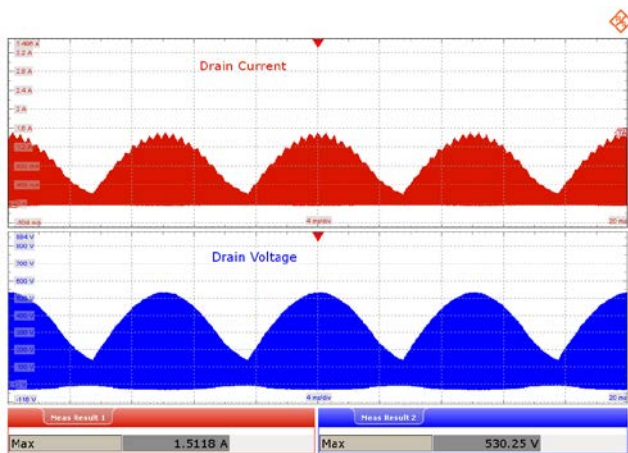

Figure 63 – 300 VAC, 75 V LED Load.
 Upper: I_{DRAIN} , 400 mA / div.
 Lower: V_{DRAIN} , 100 V / div., 4 ms / div.

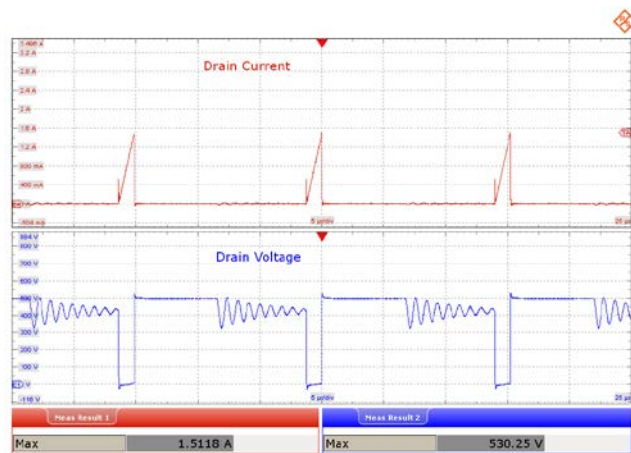

Figure 64 – 300 VAC, 75 V LED Load.
 Upper: I_{DRAIN} , 400 mA / div.
 Lower: V_{DRAIN} , 100 V / div., 5 μ s / div.

13.4 Drain Voltage and Current Start-up Profile

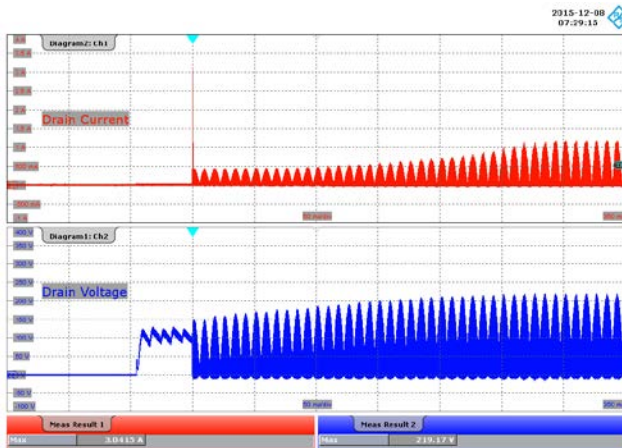

Figure 65 – 90 VAC, 75 V LED Load, Start-up.
 Upper: I_{DRAIN} , 500 mA / div.
 Lower: V_{DRAIN} , 50 V / div., 50 ms / div.

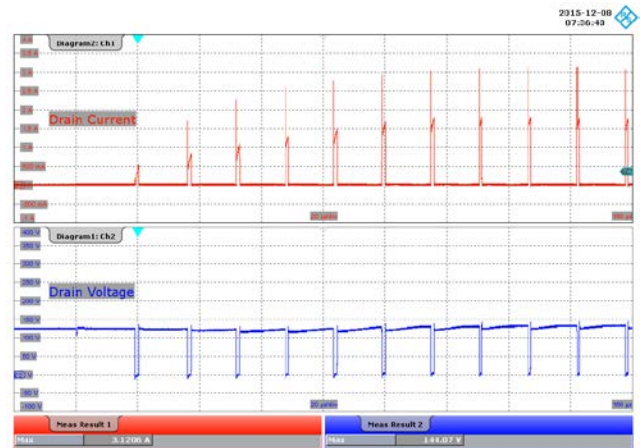

Figure 66 – 90 VAC, 75 V LED Load, Start-up.
 Upper: I_{DRAIN} , 500 mA / div.
 Lower: V_{DRAIN} , 50 V / div., 20 μ s / div.

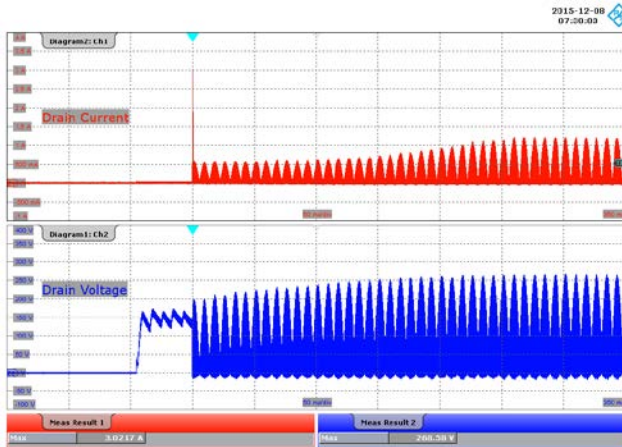

Figure 67 – 120 VAC, 75 V LED Load, Start-up.
 Upper: I_{DRAIN} , 500 mA / div.
 Lower: V_{DRAIN} , 50 V / div., 50 ms / div.

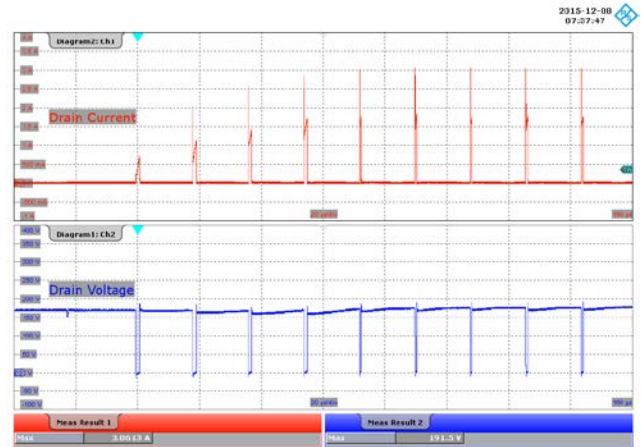

Figure 68 – 120 VAC, 75 V LED Load, Start-up.
 Upper: I_{DRAIN} , 500 mA / div.
 Lower: V_{DRAIN} , 50 V / div., 20 μ s / div.



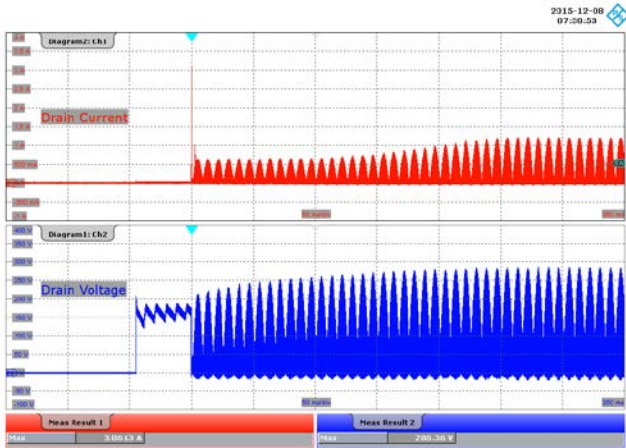

Figure 69 – 132 VAC, 75 V LED Load, Start-up.
 Upper: I_{DRAIN} , 500 mA / div.
 Lower: V_{DRAIN} , 50 V / div., 50 ms / div.

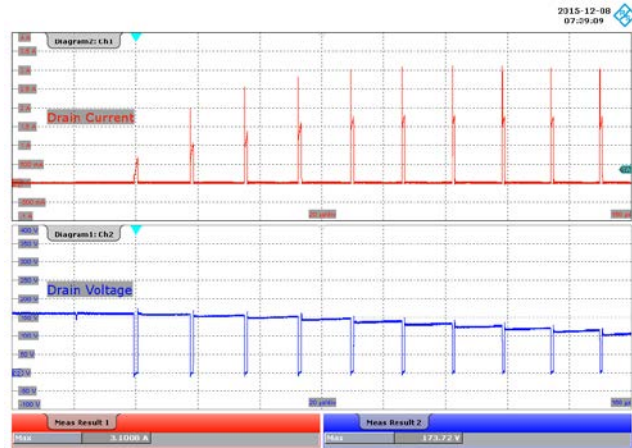

Figure 70 – 132 VAC, 75 V LED Load, Start-up.
 Upper: I_{DRAIN} , 500 mA / div.
 Lower: V_{DRAIN} , 50 V / div., 20 μ s / div.

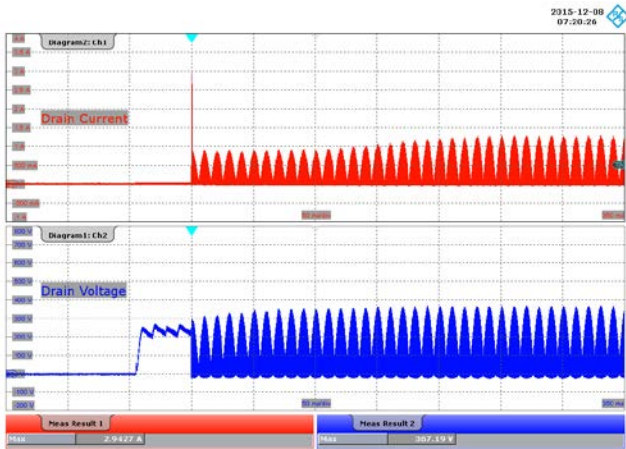

Figure 71 – 185 VAC, 75 V LED Load, Start-up.
 Upper: I_{DRAIN} , 500 mA / div.
 Lower: V_{DRAIN} , 100 V / div., 50 ms / div.

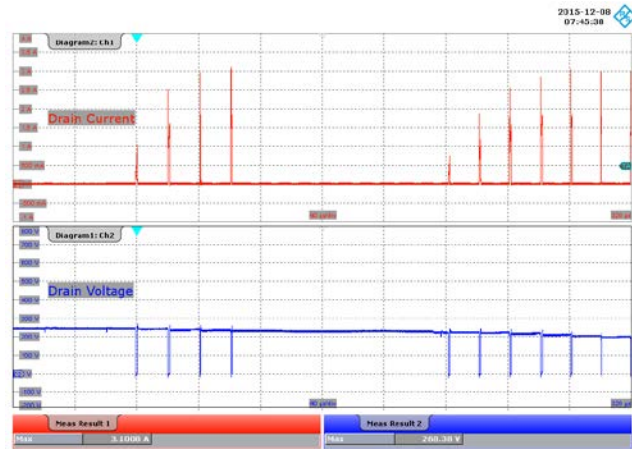

Figure 72 – 185 VAC, 75 V LED Load, Start-up.
 Upper: I_{DRAIN} , 500 mA / div.
 Lower: V_{DRAIN} , 100 V / div., 40 μ s / div.

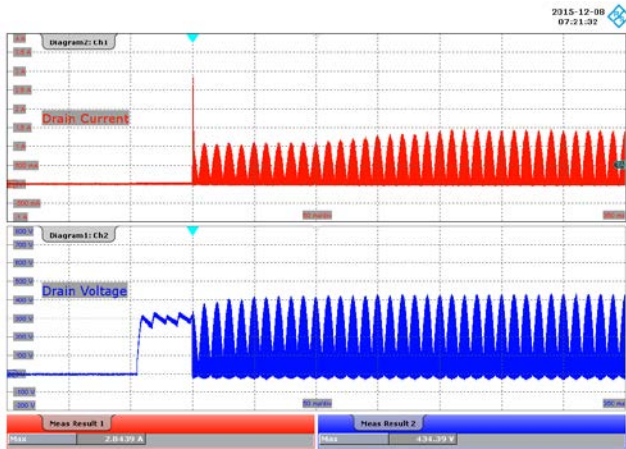

Figure 73 – 230 VAC, 75 V LED Load, Start-up.
 Upper: I_{DRAIN} , 500 mA / div.
 Lower: V_{DRAIN} , 100 V / div., 50 ms / div.

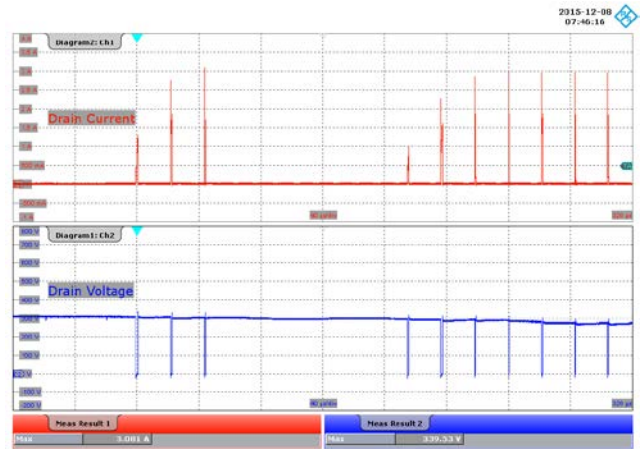

Figure 74 – 230 VAC, 75 V LED Load, Start-up.
 Upper: I_{DRAIN} , 500 mA / div.
 Lower: V_{DRAIN} , 100 V / div., 40 μ s / div.

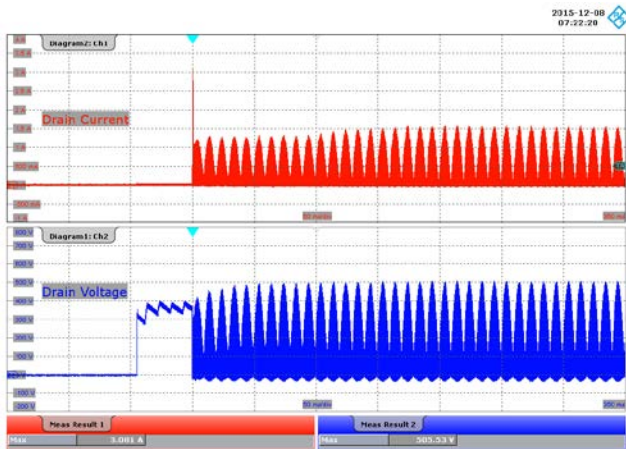

Figure 75 – 277 VAC, 75 V LED Load, Start-up.
 Upper: I_{DRAIN} , 500 mA / div.
 Lower: V_{DRAIN} , 100 V / div., 50 ms / div.

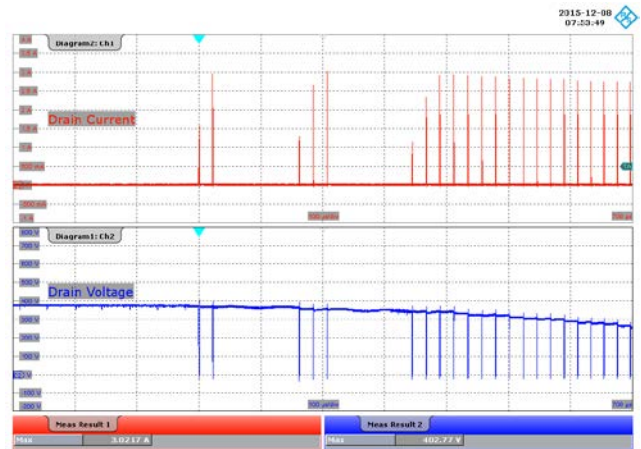

Figure 76 – 277 VAC, 75 V LED Load, Start-up.
 Upper: I_{DRAIN} , 500 mA / div.
 Lower: V_{DRAIN} , 100 V / div., 100 μ s / div.



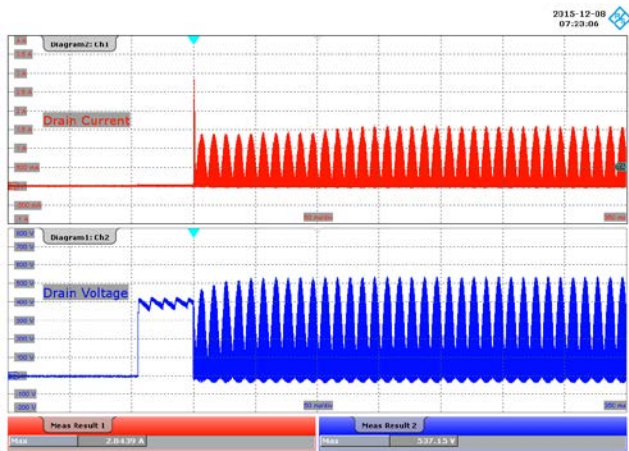

Figure 77 – 300 VAC, 75 V LED Load, Start-up.
 Upper: I_{DRAIN} , 500 mA / div.
 Lower: V_{DRAIN} , 100 V / div., 50 ms / div.

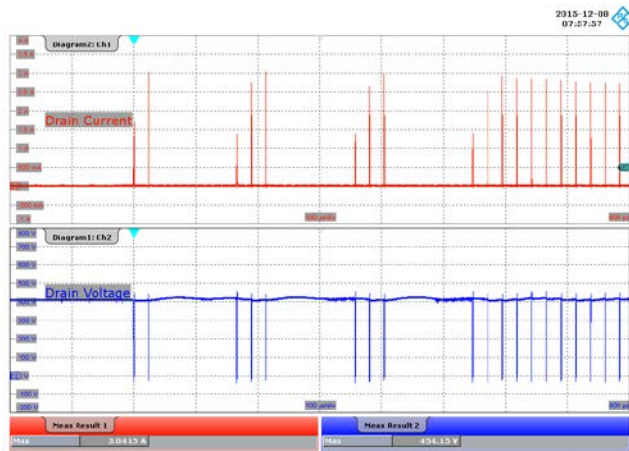

Figure 78 – 300 VAC, 75 V LED Load, Start-up.
 Upper: I_{DRAIN} , 500 mA / div.
 Lower: V_{DRAIN} , 100 V / div., 100 μ s / div.

13.5 Drain Voltage and Current during Output Short-Circuit Condition

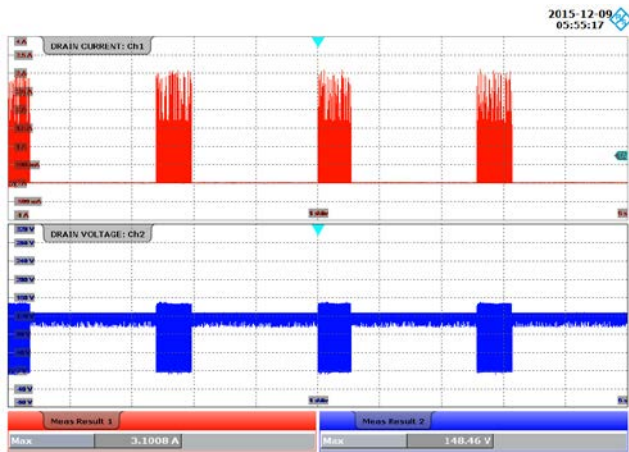

Figure 79 – 90 VAC, Output Short.
 Upper: I_{DRAIN} , 500 mA / div.
 Lower: V_{DRAIN} , 40 V / div., 1 s / div.

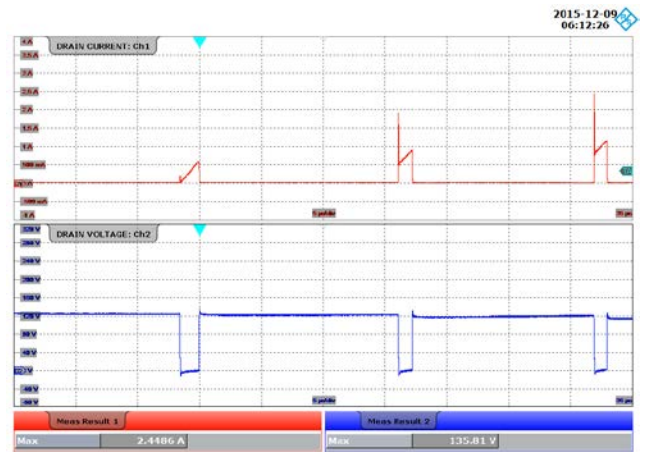

Figure 80 – 90 VAC, Output Short.
 Upper: I_{DRAIN} , 500 mA / div.
 Lower: V_{DRAIN} , 40 V / div., 5 μ s / div.

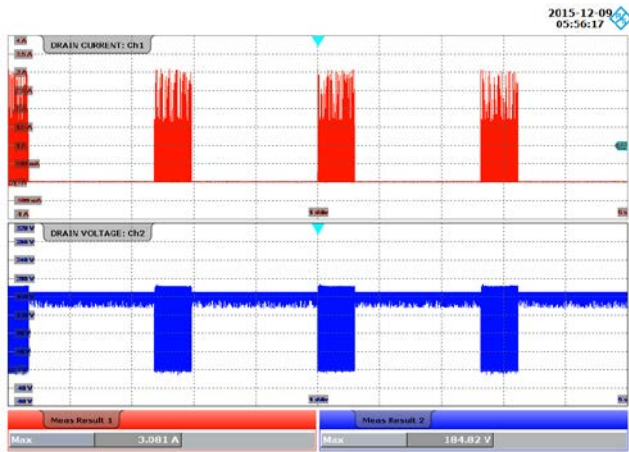

Figure 81 – 120 VAC, Output Short.
 Upper: I_{DRAIN} , 500 mA / div.
 Lower: V_{DRAIN} , 40 V / div., 1 s / div.

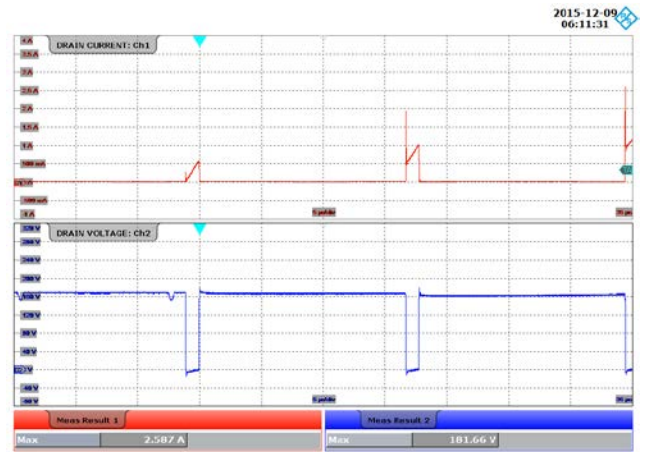

Figure 82 – 120 VAC, Output Short.
 Upper: I_{DRAIN} , 500 mA / div.
 Lower: V_{DRAIN} , 40 V / div., 5 μ s / div.



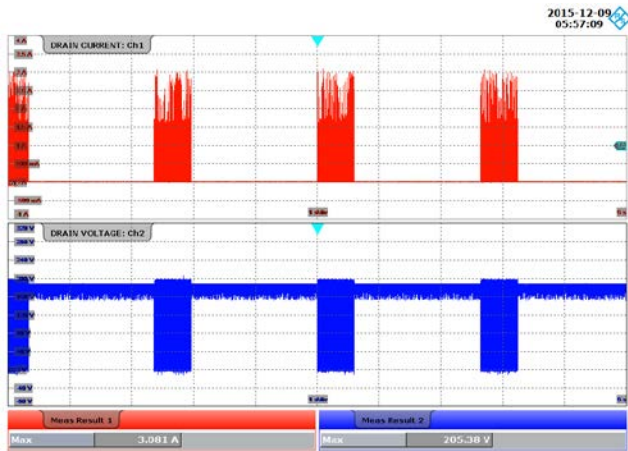

Figure 83 – 132 VAC, Output Short.
 Upper: I_{DRAIN} , 500 mA / div.
 Lower: V_{DRAIN} , 40 V / div., 1 s / div.

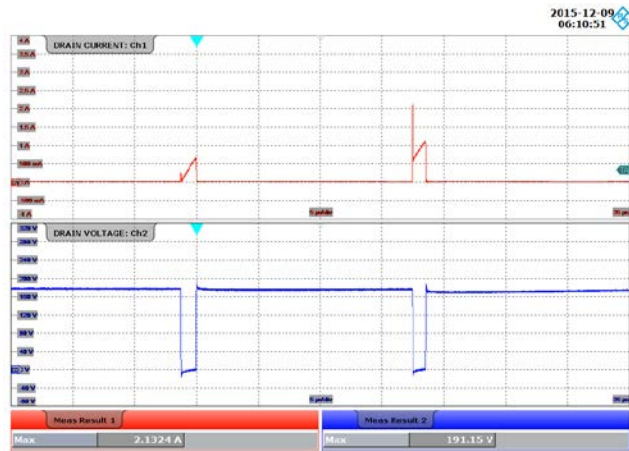

Figure 84 – 132 VAC, Output Short.
 Upper: I_{DRAIN} , 500 mA / div.
 Lower: V_{DRAIN} , 40 V / div., 5 μ s / div.

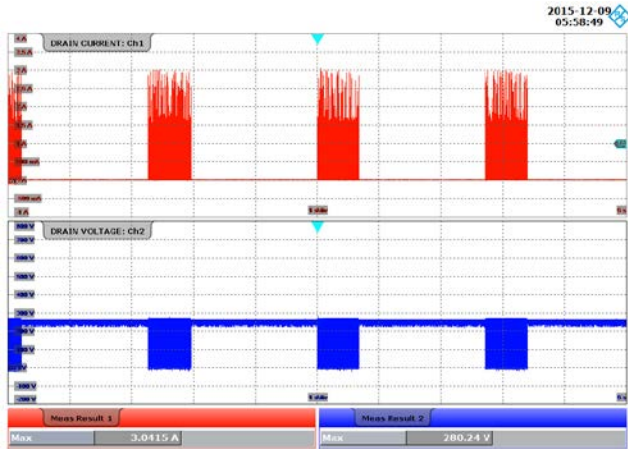

Figure 85 – 185 VAC, Output Short.
 Upper: I_{DRAIN} , 500 mA / div.
 Lower: V_{DRAIN} , 100 V / div., 1 s / div.

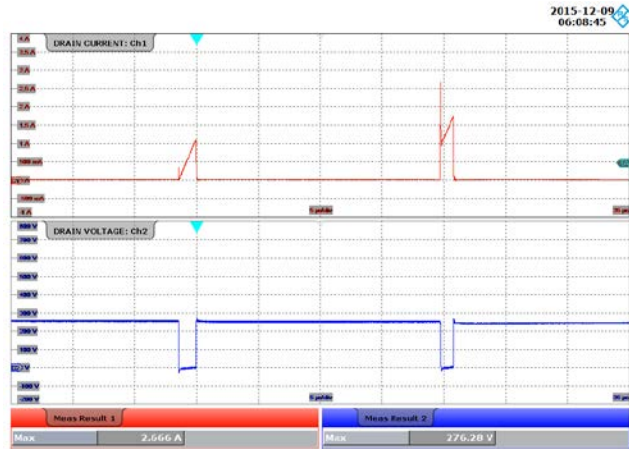

Figure 86 – 185 VAC, Output Short.
 Upper: I_{DRAIN} , 500 mA / div.
 Lower: V_{DRAIN} , 100 V / div., 5 μ s / div.

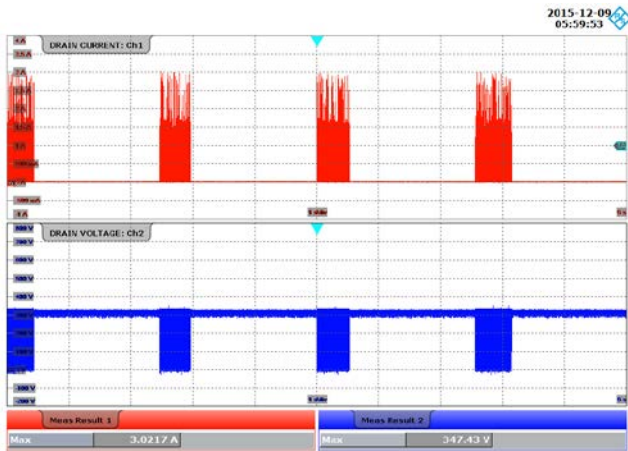

Figure 87 – 230 VAC, Output Short.
 Upper: I_{DRAIN} , 500 mA / div.
 Lower: V_{DRAIN} , 100 V / div., 1 s / div.

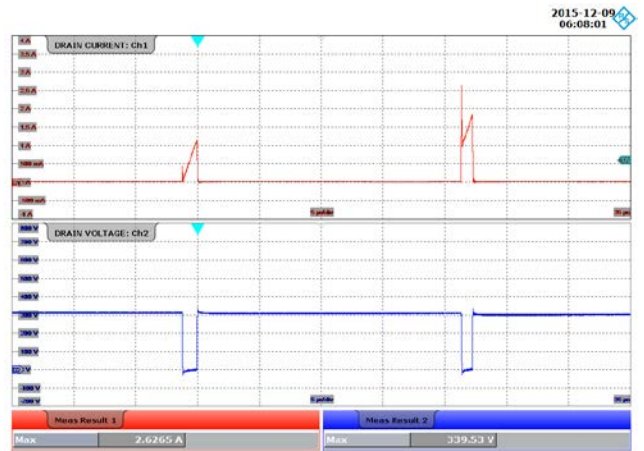

Figure 88 – 230 VAC, Output Short.
 Upper: I_{DRAIN} , 500 mA / div.
 Lower: V_{DRAIN} , 100 V / div., 5 μ s / div.

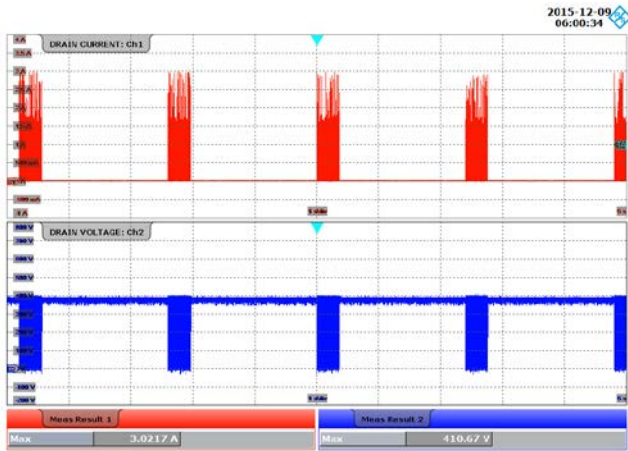

Figure 89 – 277 VAC, Output Short.
 Upper: I_{DRAIN} , 500 mA / div.
 Lower: V_{DRAIN} , 100 V / div., 1 s / div.

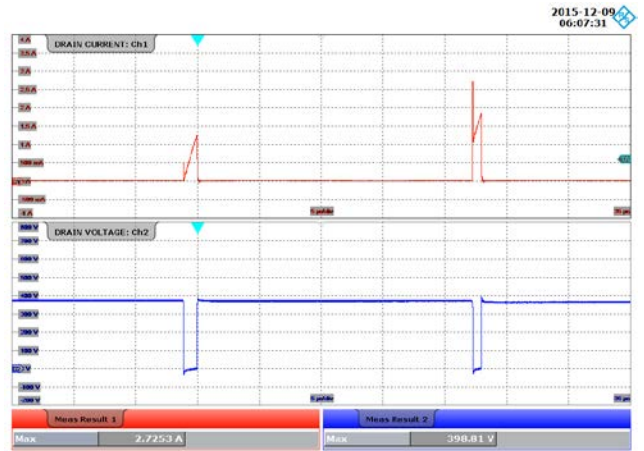

Figure 90 – 277 VAC, Output Short.
 Upper: I_{DRAIN} , 500 mA / div.
 Lower: V_{DRAIN} , 100 V / div., 5 μ s / div.



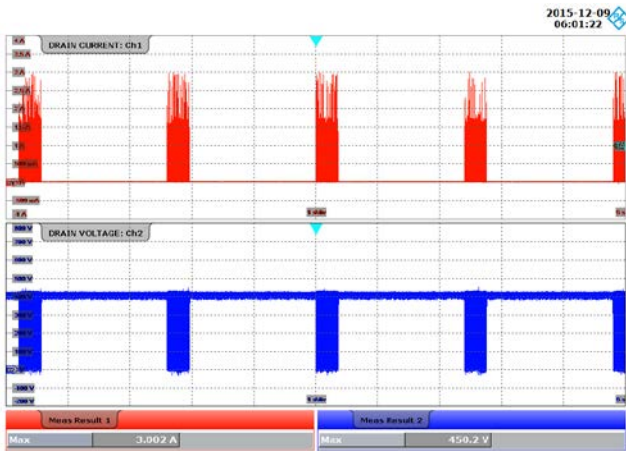

Figure 91 – 300 VAC, Output Short.
 Upper: I_{DRAIN} , 500 mA / div.
 Lower: V_{DRAIN} , 100 V / div., 1 s / div.

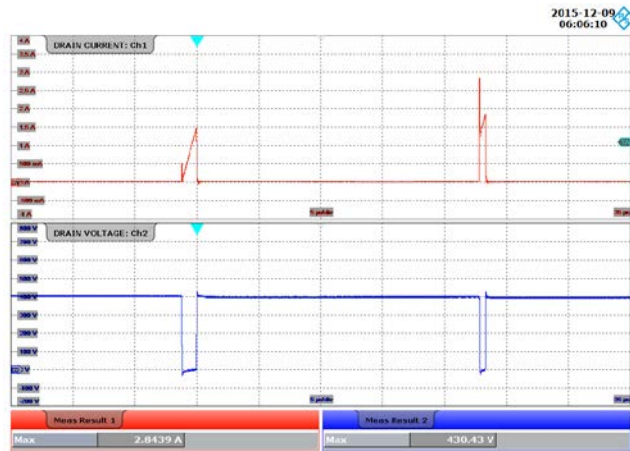

Figure 92 – 300 VAC, Output Short.
 Upper: I_{DRAIN} , 500 mA / div.
 Lower: V_{DRAIN} , 100 V / div., 5 μ s / div.

13.6 Output Diode Voltage and Current in Normal Operation

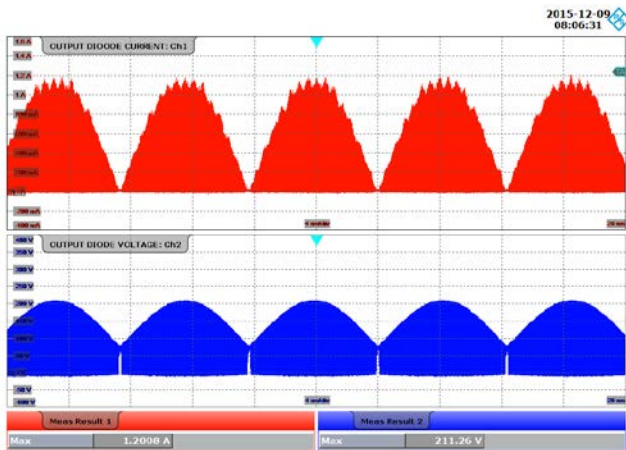

Figure 93 – 90 VAC, 75 V LED Load.
 Upper: I_{DIODE} , 200 mA / div.
 Lower: V_{DIODE} , 50 V / div., 4 ms / div.

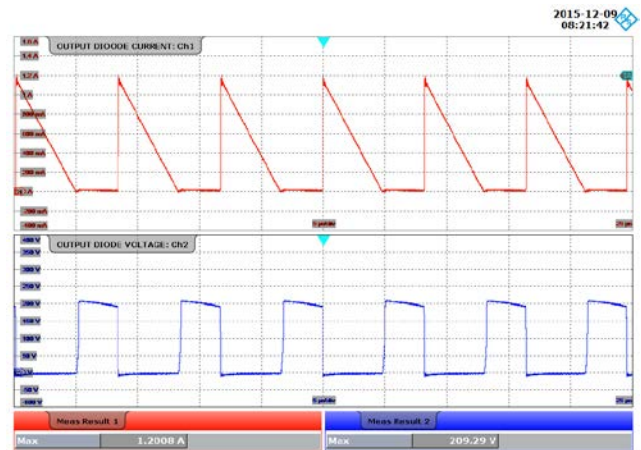

Figure 94 – 90 VAC, 75 V LED Load.
 Upper: I_{DIODE} , 200 mA / div.
 Lower: V_{DIODE} , 50 V / div., 5 μ s / div.

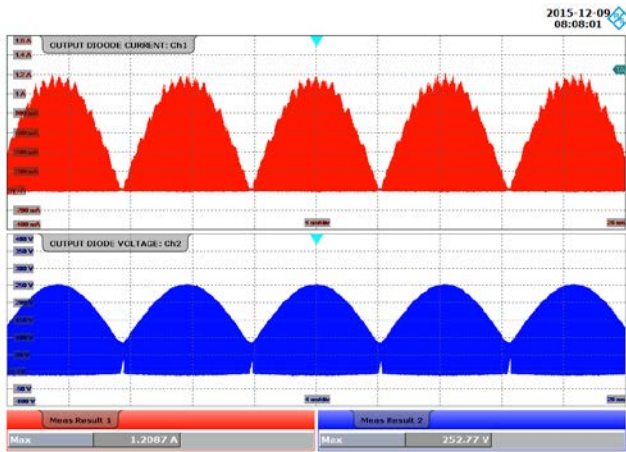

Figure 95 – 120 VAC, 75 V LED Load.
 Upper: I_{DIODE} , 200 mA / div.
 Lower: V_{DIODE} , 50 V / div., 4 ms / div.

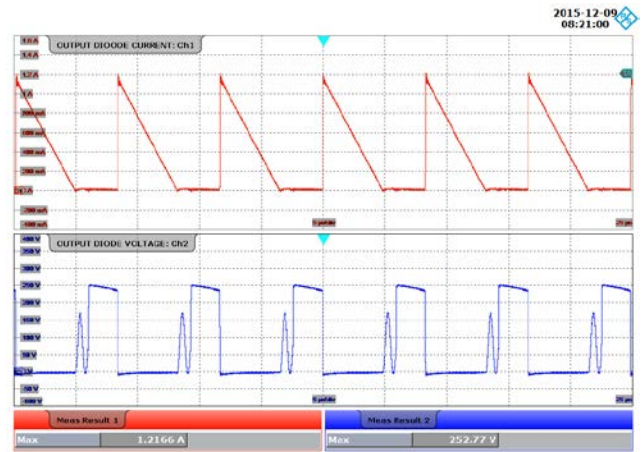

Figure 96 – 120 VAC, 75 V LED Load.
 Upper: I_{DIODE} , 200 mA / div.
 Lower: V_{DIODE} , 50 V / div., 5 μ s / div.

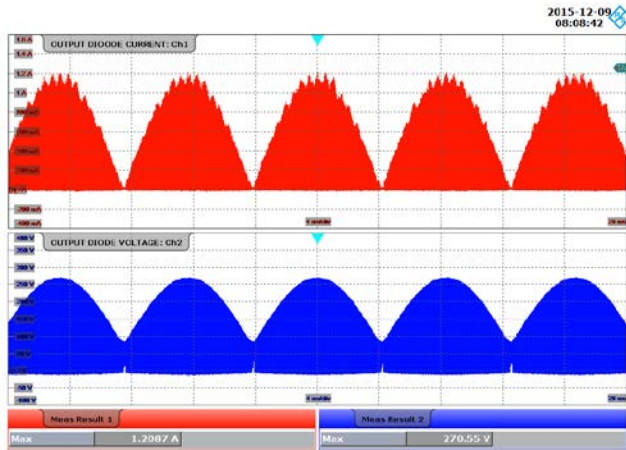

Figure 97 – 132 VAC, 75 V LED Load.
 Upper: I_{DIODE} , 200 mA / div.
 Lower: V_{DIODE} , 50 V / div., 4 ms / div.

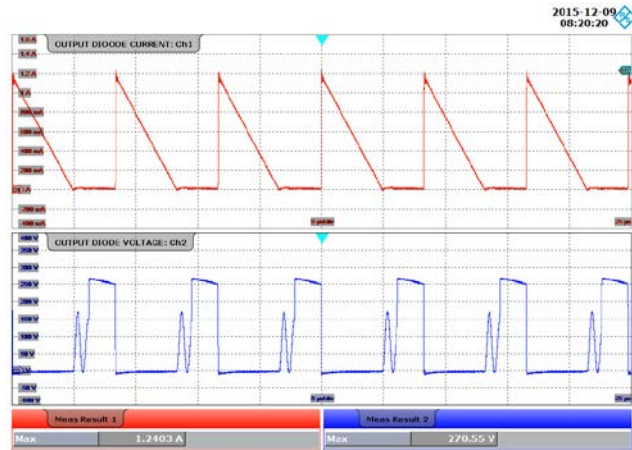

Figure 98 – 132 VAC, 75 V LED Load.
 Upper: I_{DIODE} , 200 mA / div.
 Lower: V_{DIODE} , 50 V / div., 5 μ s / div.

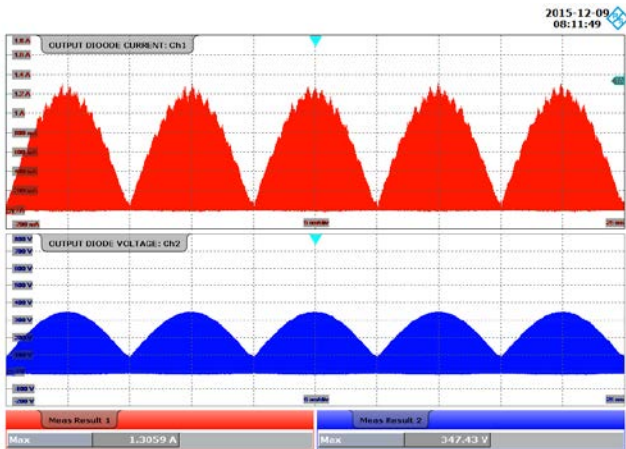

Figure 99 – 185 VAC, 75 V LED Load.
 Upper: I_{DIODE} , 200 mA / div.
 Lower: V_{DIODE} , 100 V / div., 5 ms / div.

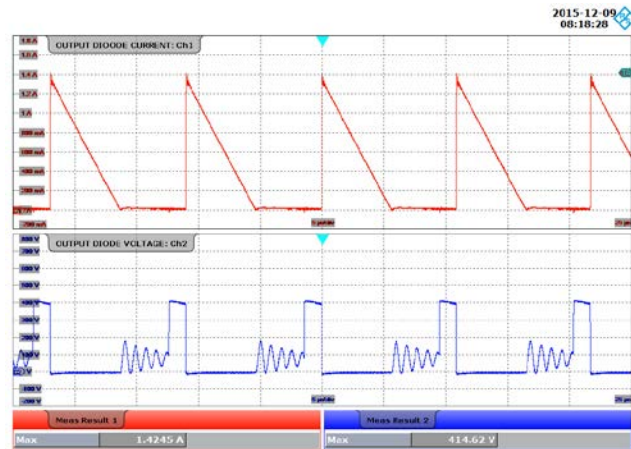

Figure 100 – 185 VAC, 75 V LED Load.
 Upper: I_{DIODE} , 200 mA / div.
 Lower: V_{DIODE} , 100 V / div., 5 μ s / div.

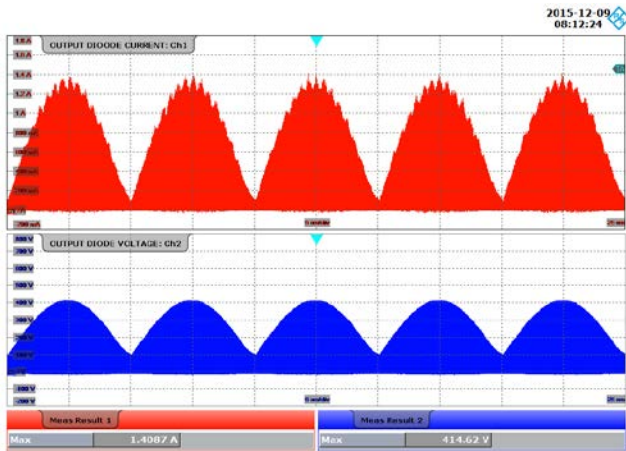

Figure 101 – 230 VAC, 75 V LED Load.
 Upper: I_{DIODE} , 200 mA / div.
 Lower: V_{DIODE} , 100 V / div., 5 ms / div.

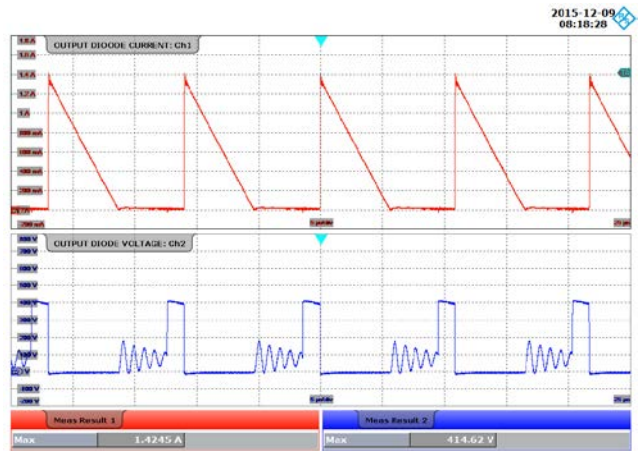

Figure 102 – 230 VAC, 75 V LED Load.
 Upper: I_{DIODE} , 200 mA / div.
 Lower: V_{DIODE} , 100 V / div., 5 μs / div.

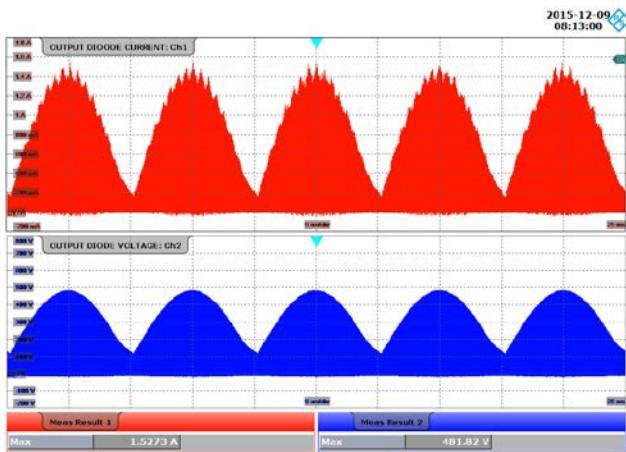

Figure 103 – 277 VAC, 75 V LED Load.
 Upper: I_{DIODE} , 200 mA / div.
 Lower: V_{DIODE} , 100 V / div., 5 ms / div.

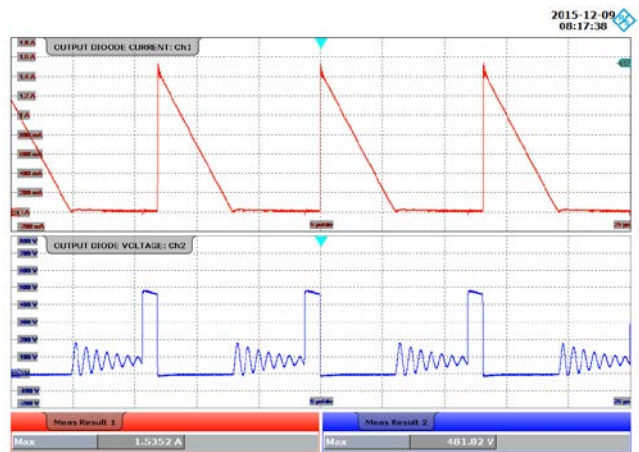

Figure 104 – 277 VAC, 75 V LED Load.
 Upper: I_{DIODE} , 200 mA / div.
 Lower: V_{DIODE} , 100 V / div., 5 μs / div.

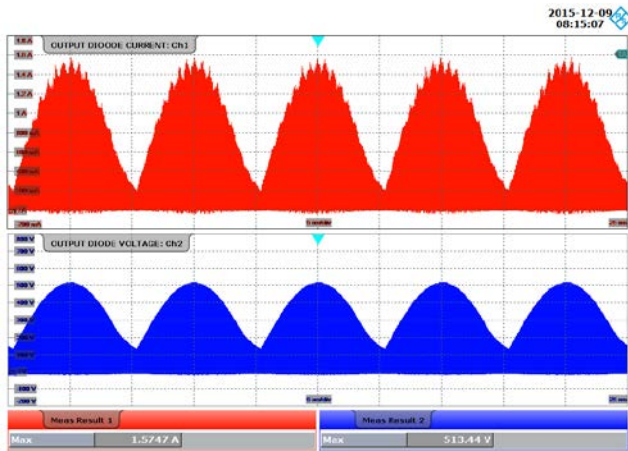

Figure 105 – 300 VAC, 75 V LED Load.
 Upper: I_{DIODE} , 200 mA / div.
 Lower: V_{DIODE} , 100 V / div., 5 ms / div.

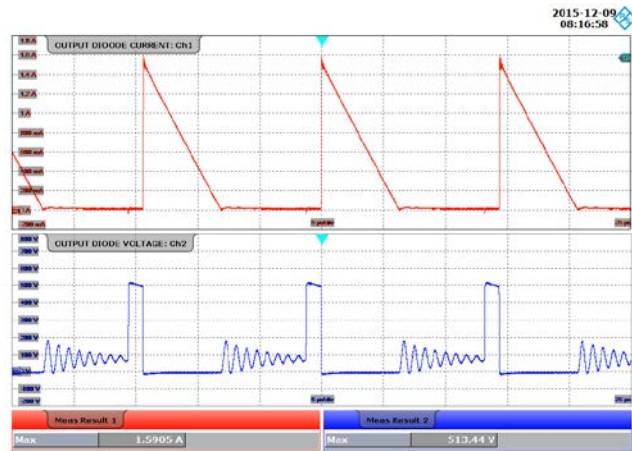

Figure 106 – 300 VAC, 75 V LED Load.
 Upper: I_{DIODE} , 200 mA / div.
 Lower: V_{DIODE} , 100 V / div., 5 μs / div.

13.7 Output Voltage and Current - Open LED Load

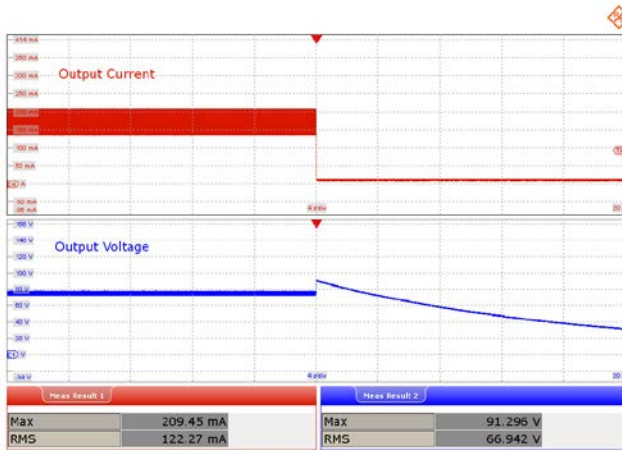

Figure 107 – 90 VAC, 75 V LED Load, Running Open Load.
Upper: I_{OUT} , 50 mA / div.
Lower: V_{OUT} , 20 V / div., 4 s / div.

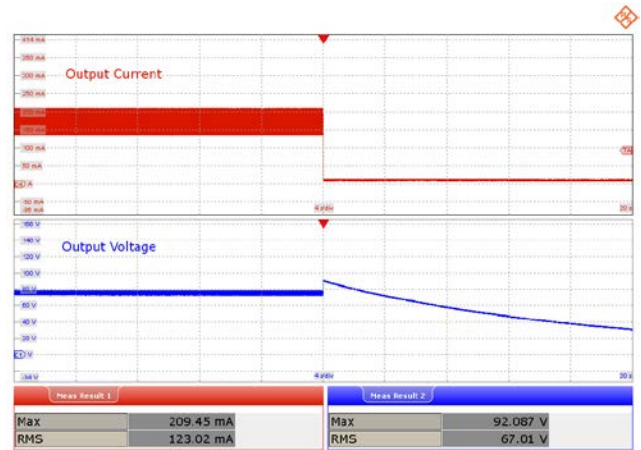

Figure 108 – 120 VAC, 75 V LED Load, Running Open Load.
Upper: I_{OUT} , 50 mA / div.
Lower: V_{OUT} , 20 V / div., 4 s / div.

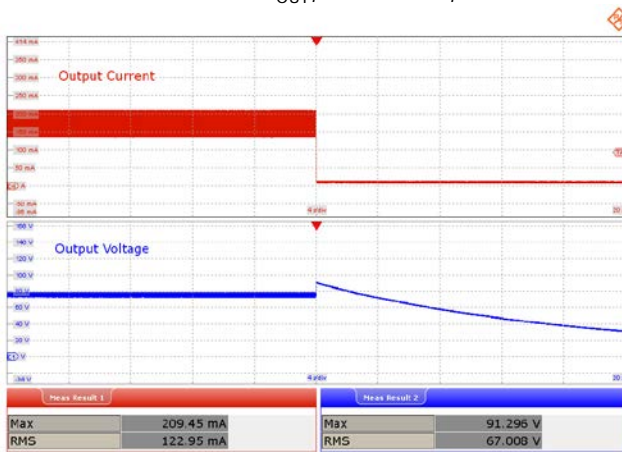

Figure 109 – 132 VAC, 75 V LED Load, Running Open Load.
Upper: I_{OUT} , 50 mA / div.
Lower: V_{OUT} , 20 V / div., 4 s / div.



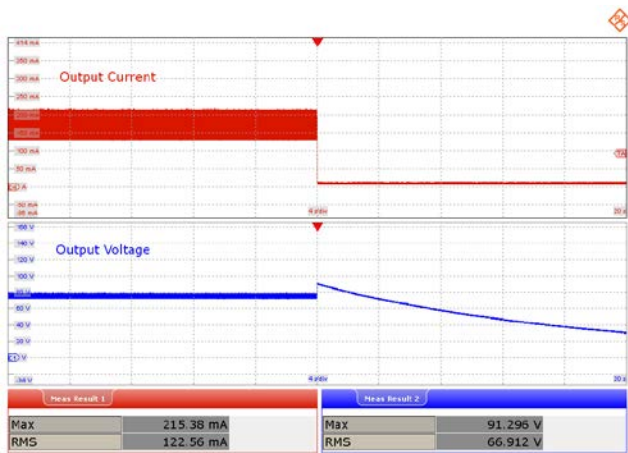

Figure 110 – 185 VAC, 75 V LED Load, Running Open Load.
 Upper: I_{OUT} , 50 mA / div.
 Lower: V_{OUT} , 20 V / div., 4 s / div.

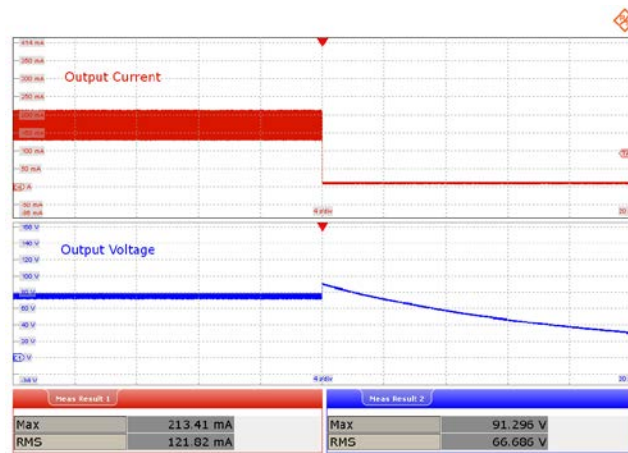

Figure 111 – 230 VAC, 75 V LED Load, Running Open Load.
 Upper: I_{OUT} , 50 mA / div.
 Lower: V_{OUT} , 20 V / div., 4 s / div.

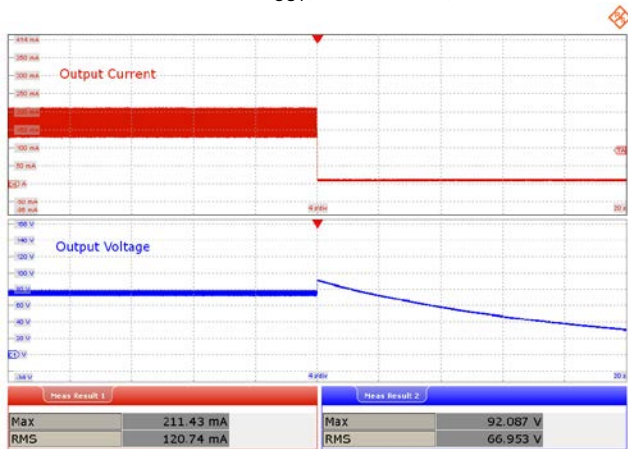

Figure 112 – 277 VAC, 75 V LED Load, Running Open Load.
 Upper: I_{OUT} , 50 mA / div.
 Lower: V_{OUT} , 20 V / div., 4 s / div.

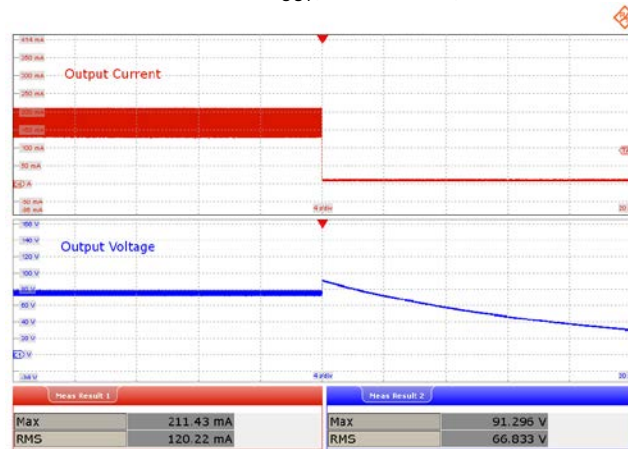

Figure 113 – 300 VAC, 75 V LED Load, Running Open Load.
 Upper: I_{OUT} , 50 mA / div.
 Lower: V_{OUT} , 20 V / div., 4 s / div.

13.8 Output Ripple Current

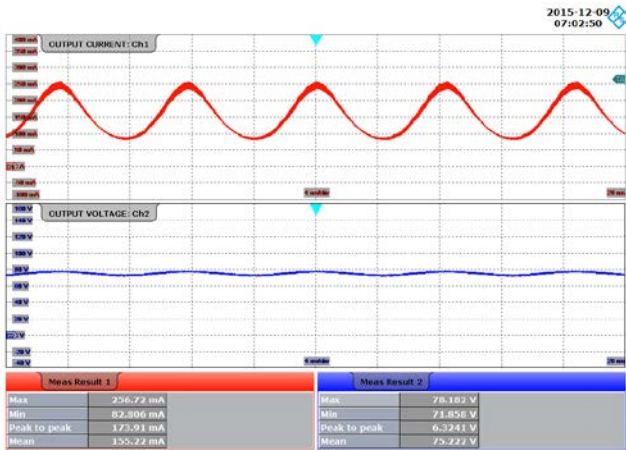

Figure 114 – 90 VAC, 60 Hz, 75 V LED Load.
Upper: I_{OUT} , 100 mA / div.
Lower: V_{OUT} , 20 V / div., 4 ms / div.

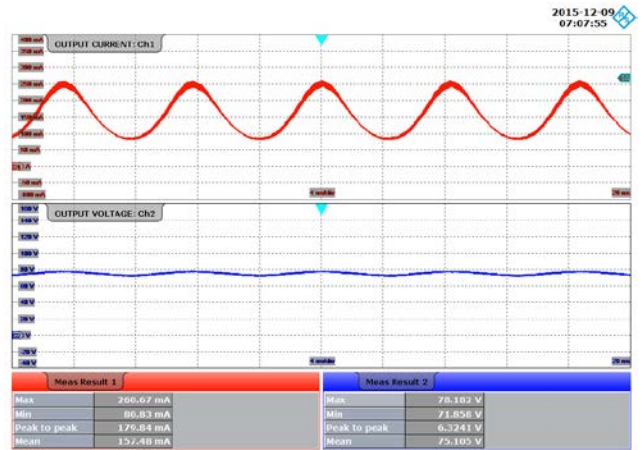

Figure 115 – 120 VAC, 60 Hz, 75 V LED Load.
Upper: I_{OUT} , 100 mA / div.
Lower: V_{OUT} , 20 V / div., 4 ms / div.

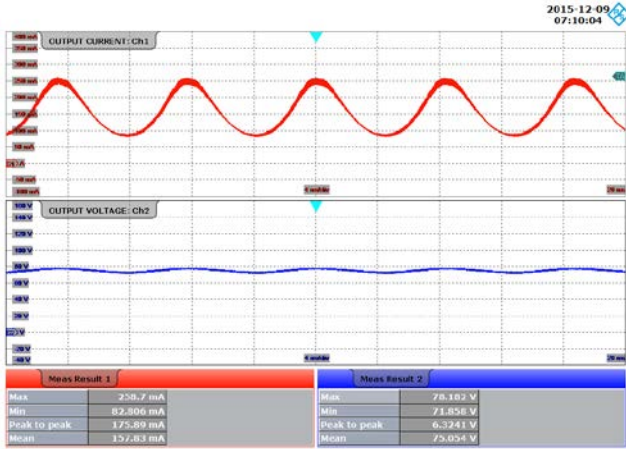

Figure 116 – 132 VAC, 60 Hz, 75 V LED Load.
Upper: I_{OUT} , 100 mA / div.
Lower: V_{OUT} , 20 V / div., 4 ms / div.

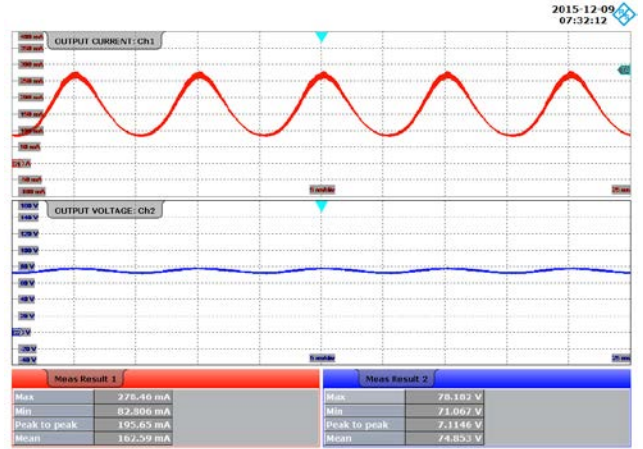

Figure 117 – 185 VAC, 50 Hz, 75 V LED Load.
Upper: I_{OUT} , 100 mA / div.
Lower: V_{OUT} , 20 V / div., 5 ms / div.



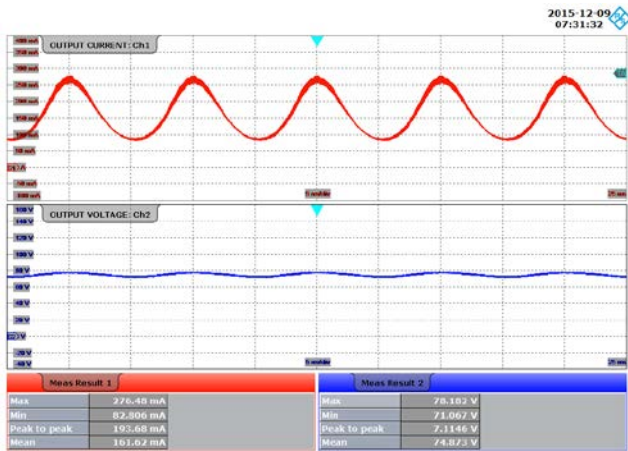

Figure 118 – 230 VAC, 50 Hz, 75 V LED Load.
Upper: I_{OUT} , 100 mA / div.
Lower: V_{OUT} , 20 V / div., 5 ms / div.

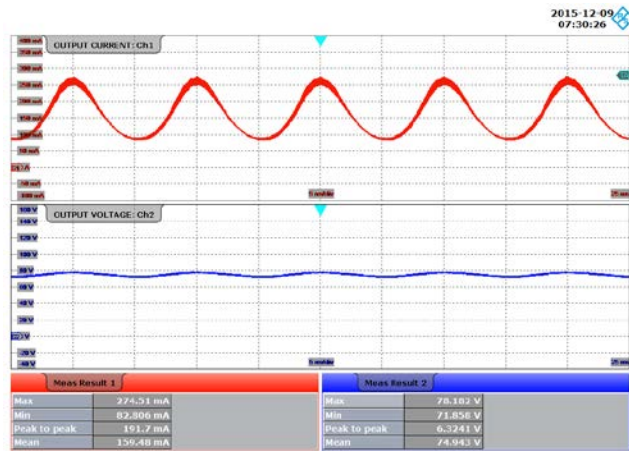

Figure 119 – 277 VAC, 50 Hz, 75 V LED Load.
Upper: I_{OUT} , 100 mA / div.
Lower: V_{OUT} , 20 V / div., 5 ms / div.

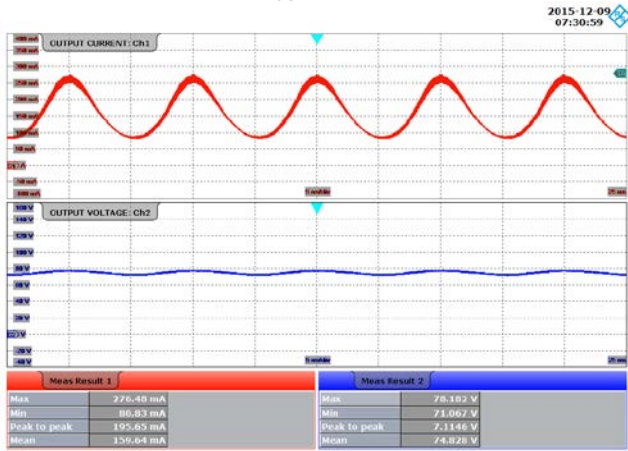

Figure 120 – 300 VAC, 50 Hz, 75 V LED Load.
Upper: I_{OUT} , 100 mA / div.
Lower: V_{OUT} , 20 V / div., 5 ms / div.

V_{IN}	$I_{OUT(MAX)}$ (mA)	$I_{OUT(MIN)}$ (mA)	I_{MEAN} (mA)	Ripple Ratio (I_{RP-P}/I_{MEAN})	% Flicker $100 \times (I_{RP-P} / I_{OUT(MAX)} + I_{OUT(MIN)})$
90 VAC	256.72	82.806	155.22	1.12	51.22
120 VAC	260.67	80.830	157.48	1.14	52.66
132 VAC	258.70	82.806	157.83	1.11	51.50
185 VAC	278.46	82.806	162.59	1.20	54.15
230 VAC	276.48	82.806	161.62	1.19	53.90
277 VAC	274.51	82.806	159.48	1.20	53.65
300 VAC	276.48	80.830	159.64	1.22	54.75

14 AC Cycling Test

No output current overshoot was observed during on - off cycling.

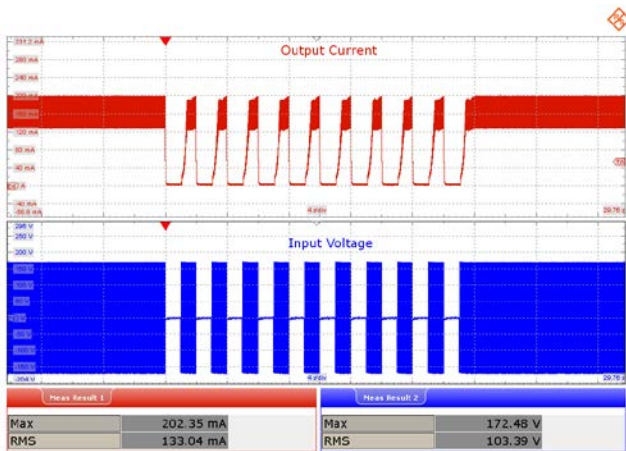

Figure 121 – 120 VAC, 75 V LED Load.
 1 s On – 1 s Off.
 Upper: I_{OUT} , 40 mA / div.
 Lower: V_{IN} , 50 V / div., 4 s / div.

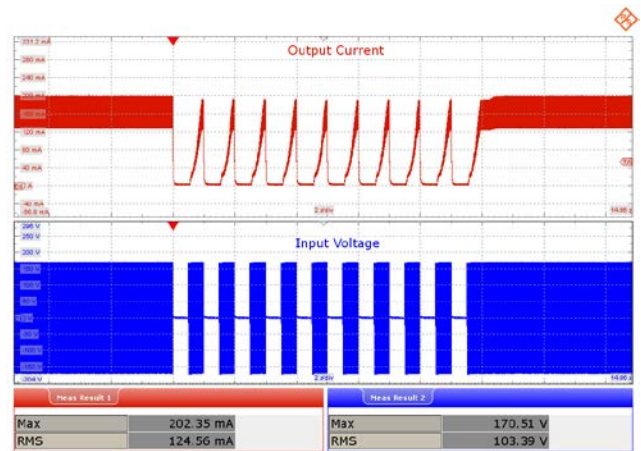

Figure 122 – 120 VAC, 75 V LED Load.
 500 ms On – 500 ms Off.
 Upper: I_{OUT} , 40 mA / div.
 Lower: V_{IN} , 50 V / div., 2 s / div.

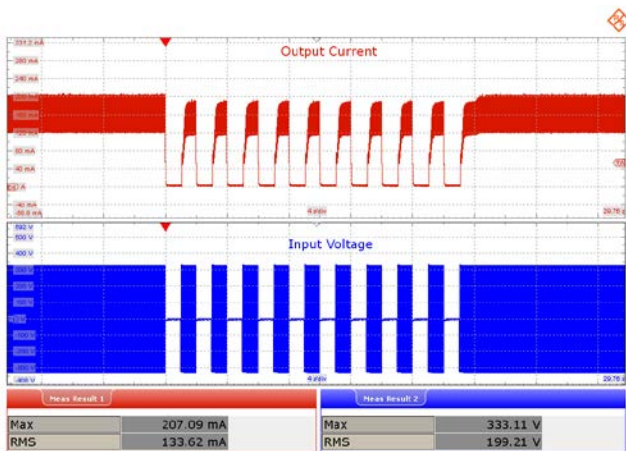

Figure 123 – 230 VAC, 75 V LED Load.
 1 s On – 1 s Off.
 Upper: I_{OUT} , 40 mA / div.
 Lower: V_{IN} , 100 V / div., 4 s / div.

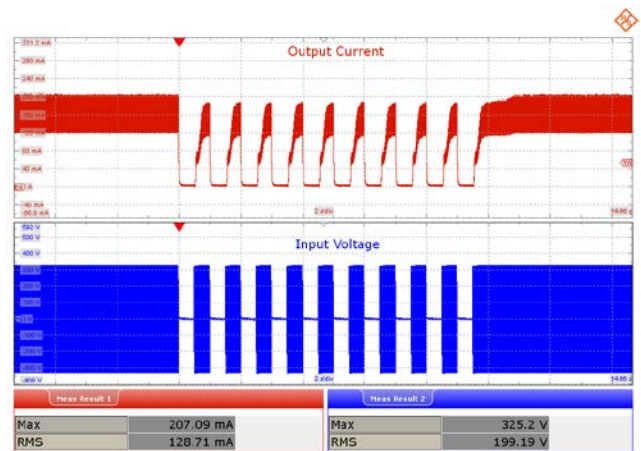

Figure 124 – 230 VAC, 75 V LED Load.
 500 ms On – 500 ms Off.
 Upper: I_{OUT} , 40 mA / div.
 Lower: V_{IN} , 100 V / div., 2 s / div.



15 Conducted EMI

15.1 Test Set-up

15.1.1 Equipment and Load Used

1. Rohde and Schwarz ENV216 two line V-network.
2. Rohde and Schwarz ESRP EMI test receiver.
3. Hioki 3322 power hitester.
4. Chroma measurement test fixture.
5. 75 V LED load with input voltage set at 230 VAC.

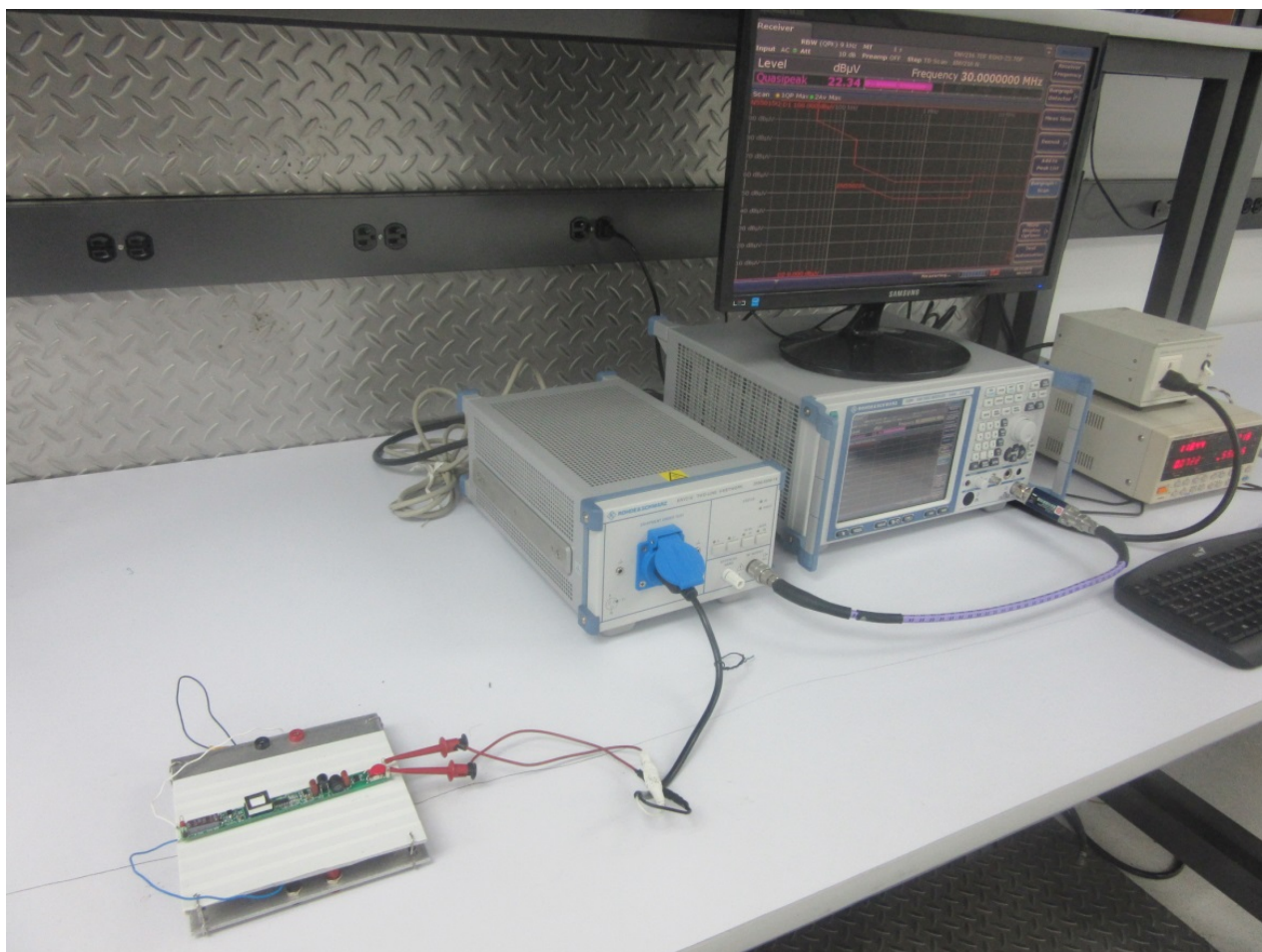

Figure 125 – Conducted EMI Test Set-up.

15.2 EMI Test Result

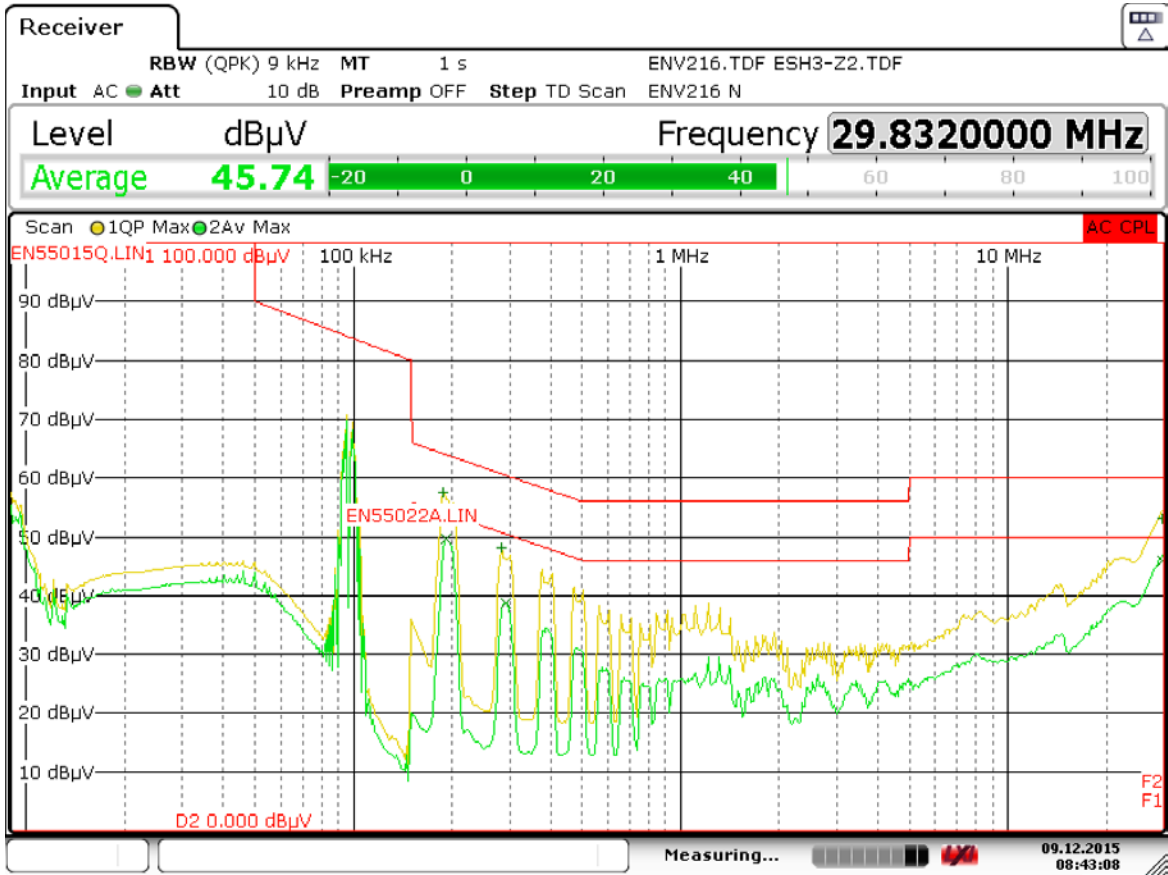

Figure 126 – Conducted EMI, 75 V LED Load, 230 VAC, 50 Hz, EN55015 B Limits.

Trace1: EN55015Q.LIN		Trace2: EN55022A.LIN	
Trace/Detector	Frequency	Level dBμV	DeltaLimit
1 Quasi Peak	188.2500 kHz	57.66 N	-6.45 dB
2 Average	192.7500 kHz	49.55 N	-4.37 dB
1 Quasi Peak	282.7500 kHz	48.14 N	-12.59 dB
2 Average	291.7500 kHz	38.63 N	-11.84 dB
1 Quasi Peak	29.8298 MHz	53.20 N	-6.80 dB
2 Average	29.8320 MHz	45.92 N	-4.08 dB

Figure 127 – Conducted EMI, 75 V LED Load, 230 VAC, 50 Hz, Final Measurement Results.



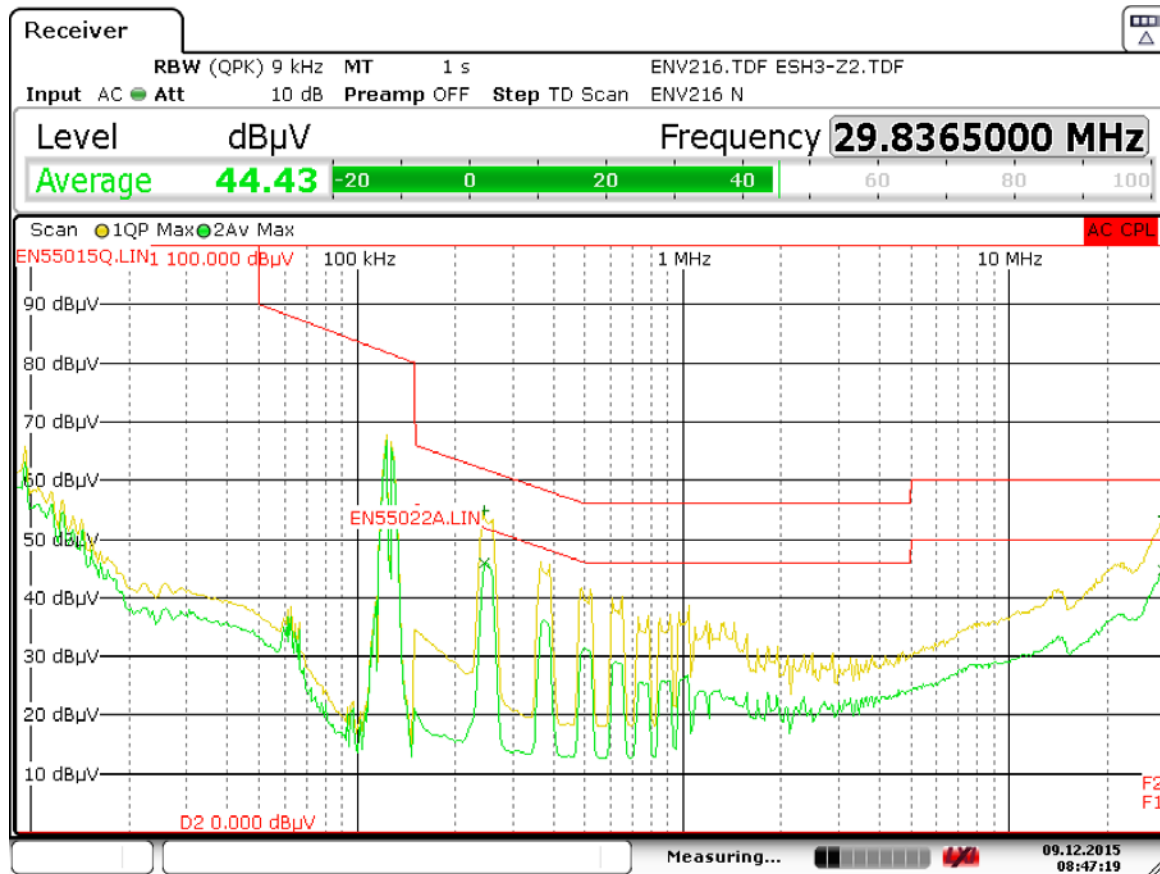

Figure 128 – Conducted EMI, 75 V LED Load, 115 VAC, 60 Hz, EN55015 B Limits.

Trace1: EN55015Q.LIN		Trace2: EN55022A.LIN	
Trace/Detector	Frequency	Level dBµV	DeltaLimit
1 Quasi Peak	244.5000 kHz	54.90 N	-7.04 dB
2 Average	246.7500 kHz	45.90 N	-5.97 dB
1 Quasi Peak	29.8028 MHz	53.84 N	-6.16 dB
2 Average	29.8365 MHz	44.57 N	-5.43 dB

Figure 129 – Conducted EMI, 75 V LED Load, 115 VAC, 60 Hz, Final Measurement Results.

16 Line Surge

The unit was subjected to ± 3500 V, 100 kHz ring wave and ± 3000 V differential surge using 10 strikes at each condition. A test failure was defined as a non-recoverable interruption of output requiring repair or recycling of input voltage.

DM Surge Level (V)	Input Voltage (VAC)	Injection Location	Injection Phase (°)	Test Result (Pass/Fail)
+3000	230	L to N	0	Pass
-3000	230	L to N	0	Pass
+3000	230	L to N	90	Pass
-3000	230	L to N	90	Pass
+3000	230	L to N	270	Pass
-3000	230	L to N	270	Pass

RW Surge Level (V)	Input Voltage (VAC)	Injection Location	Injection Phase (°)	Test Result (Pass/Fail)
+3500	230	L to N	0	Pass
-3500	230	L to N	0	Pass
+3500	230	L to N	90	Pass
-3500	230	L to N	90	Pass
+3500	230	L to N	270	Pass
-3500	230	L to N	270	Pass

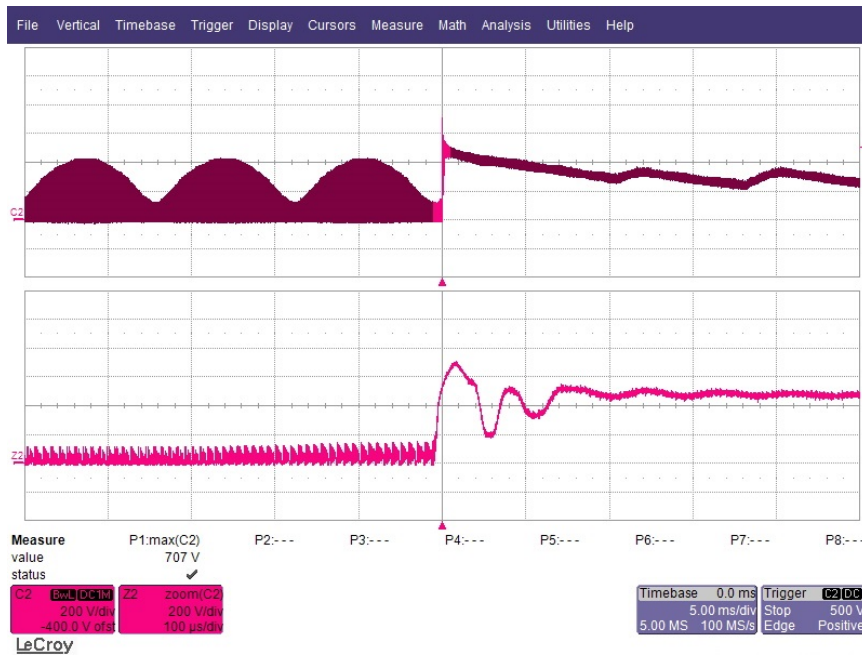

Figure 130 – (+)3.0 kV Differential Surge, 0° Phase.
 Upper: V_{DRAIN} , 200 V / div., 5 ms / div.
 Lower: $V_{DRAIN(ZOOMED)}$, 200 V / div., 100 μs / div.
 Peak V_{DRAIN} : 707 V.

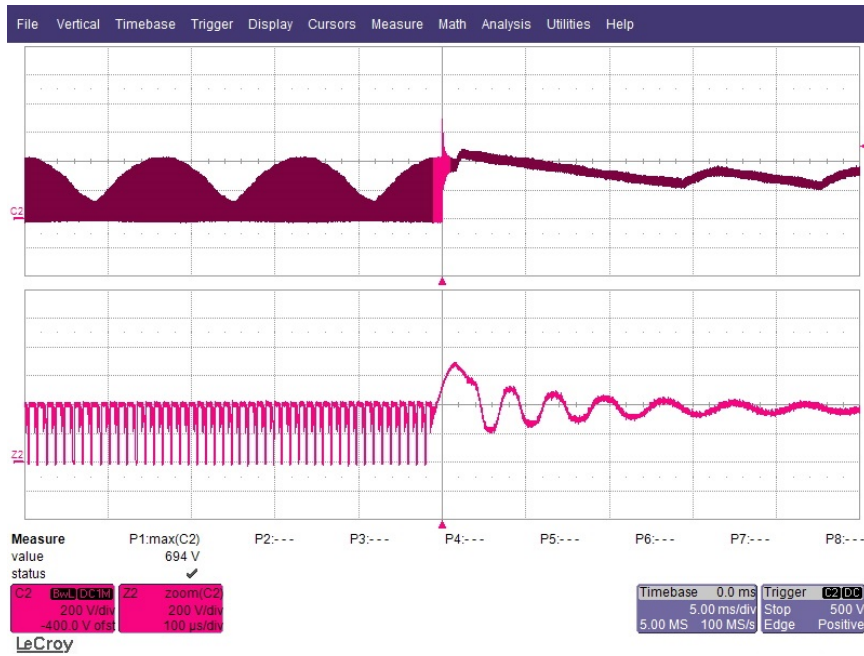

Figure 131 – (+)3.0 kV Differential Surge, 90° Phase.
 Upper: V_{DRAIN} , 200 V / div., 5 ms / div.
 Lower: $V_{DRAIN(ZOOMED)}$, 200 V / div., 100 μ s / div.
 Peak V_{DRAIN} : 694 V.



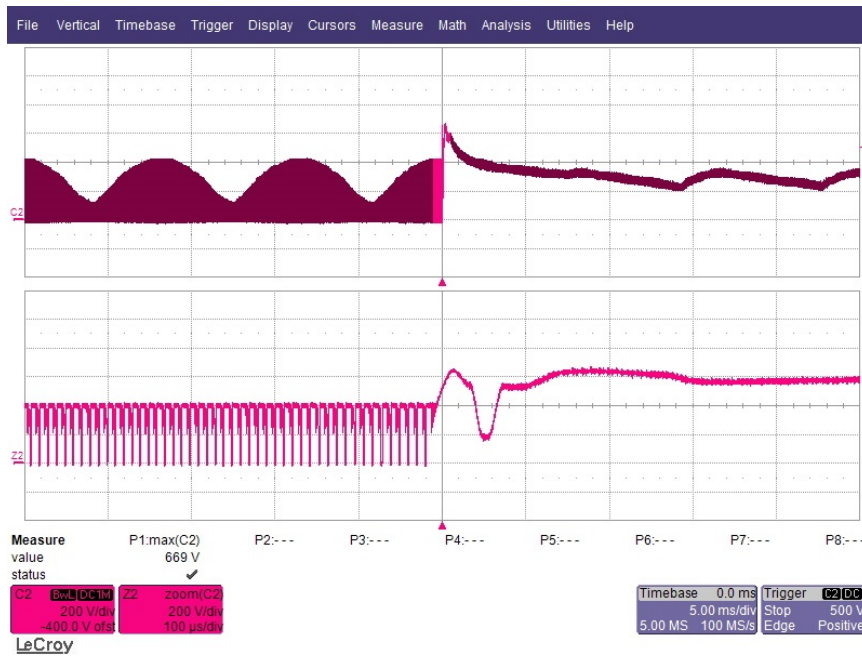

Figure 132 – (+)3.0 kV Differential Surge, 270° Phase.
 Upper: V_{DRAIN} , 200 V / div., 5 ms / div.
 Lower: $V_{DRAIN(ZOOMED)}$, 200 V / div., 100 μs / div.
 Peak V_{DRAIN} : 669 V.

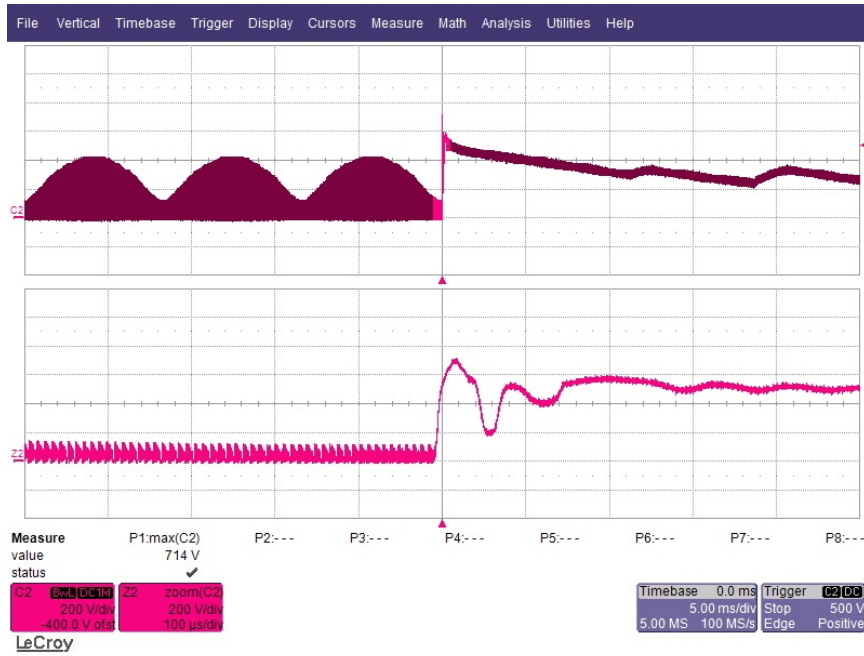

Figure 133 – (-)3.0 kV Differential Surge, 0° Phase.
 Upper: V_{DRAIN} , 200 V / div., 5 ms / div.
 Lower: $V_{DRAIN(ZOOMED)}$, 200 V / div., 100 μs / div.
 Peak V_{DRAIN} : 714 V.



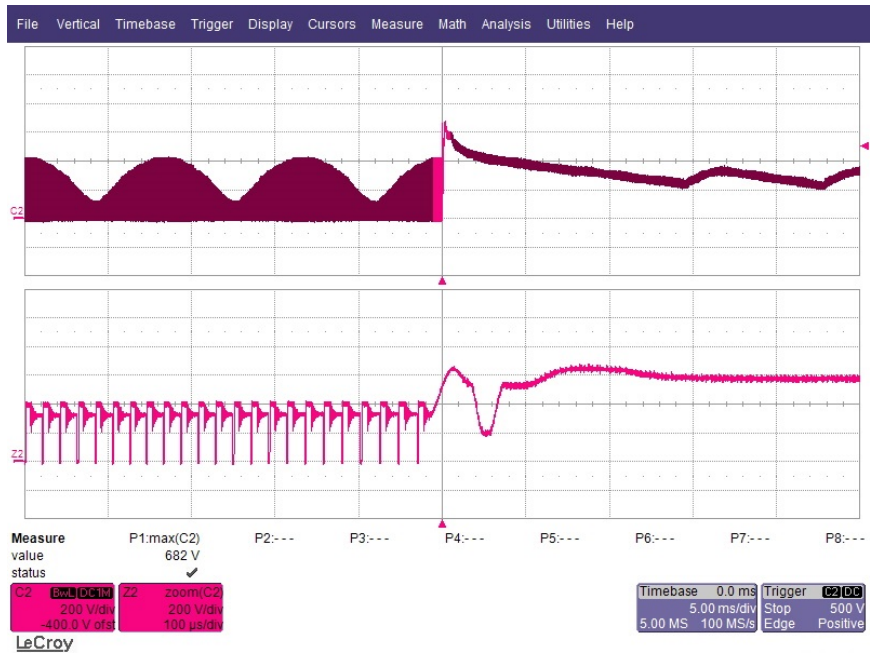

Figure 134 – (-)3.0 kV Differential Surge, 90° Phase.
 Upper: V_{DRAIN} , 200 V / div., 5 ms / div.
 Lower: $V_{DRAIN(ZOOMED)}$, 200 V / div., 100 µs / div.
 Peak V_{DRAIN} : 682 V.

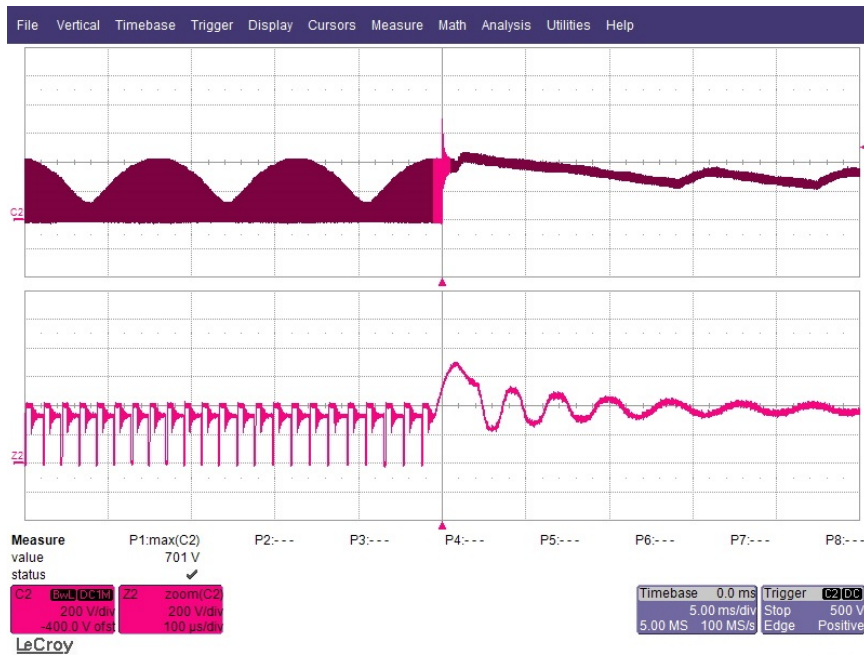

Figure 135 – (-)3.0 kV Differential Surge, 270° Phase.
 Upper: V_{DRAIN} , 200 V / div., 5 ms / div.
 Lower: $V_{DRAIN(ZOOMED)}$, 200 V / div., 100 µs / div.
 Peak V_{DRAIN} : 701 V.



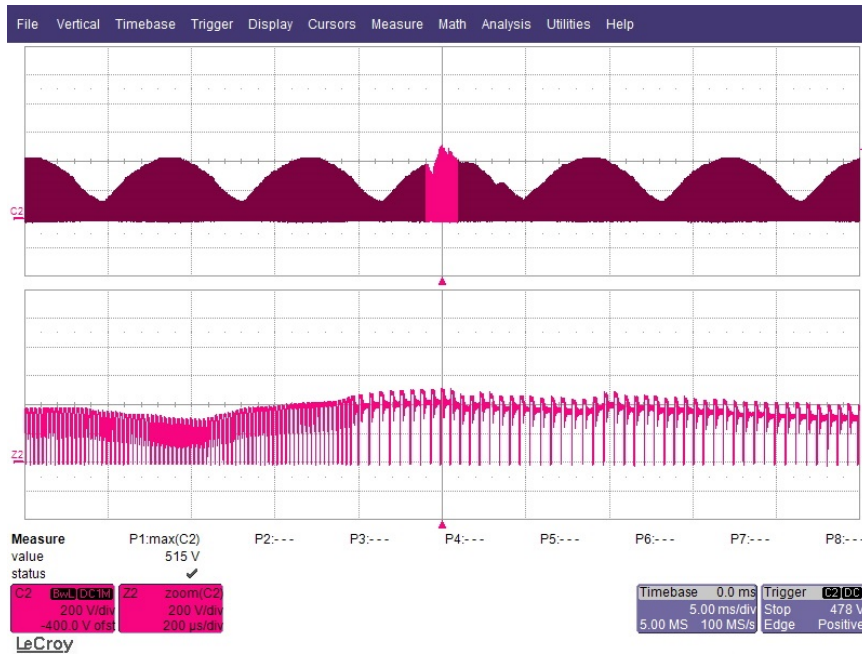
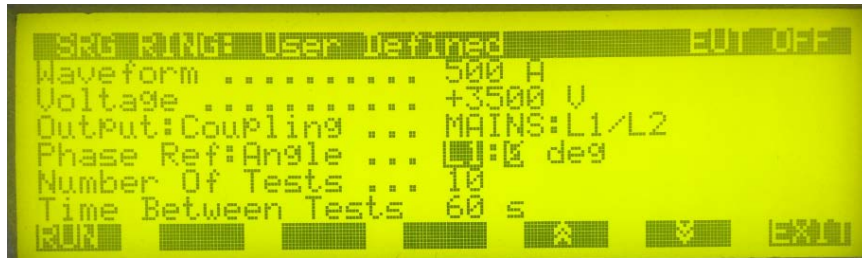

Figure 136 – (+)3.5 kV Ring Wave, 0° Phase.
 Upper: V_{DRAIN} , 200 V / div., 5 ms / div.
 Lower: $V_{DRAIN(ZOOMED)}$, 200 V / div., 100 μs / div.
 Peak V_{DRAIN} : 515 V.

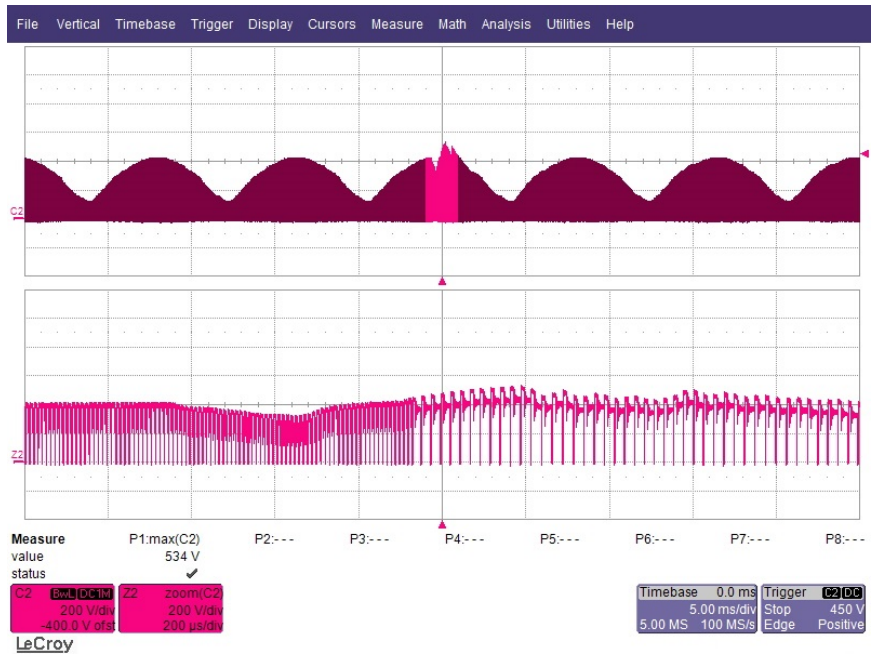
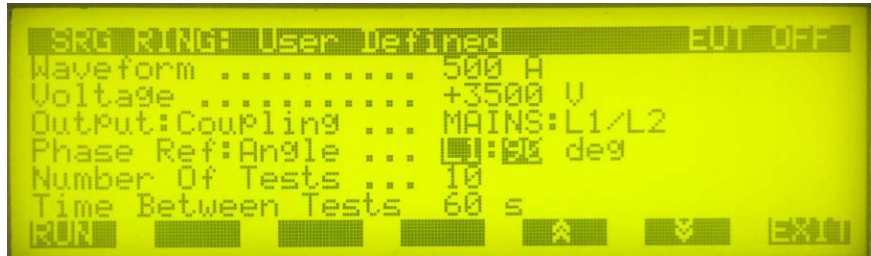

Figure 137 – (+)3.5 kV Ring Wave, 90° Phase.
Upper: V_{DRAIN} , 200 V / div., 5 ms / div.
Lower: $V_{DRAIN(ZOOMED)}$, 200 V / div., 100 μ s / div.
Peak V_{DRAIN} : 534 V.



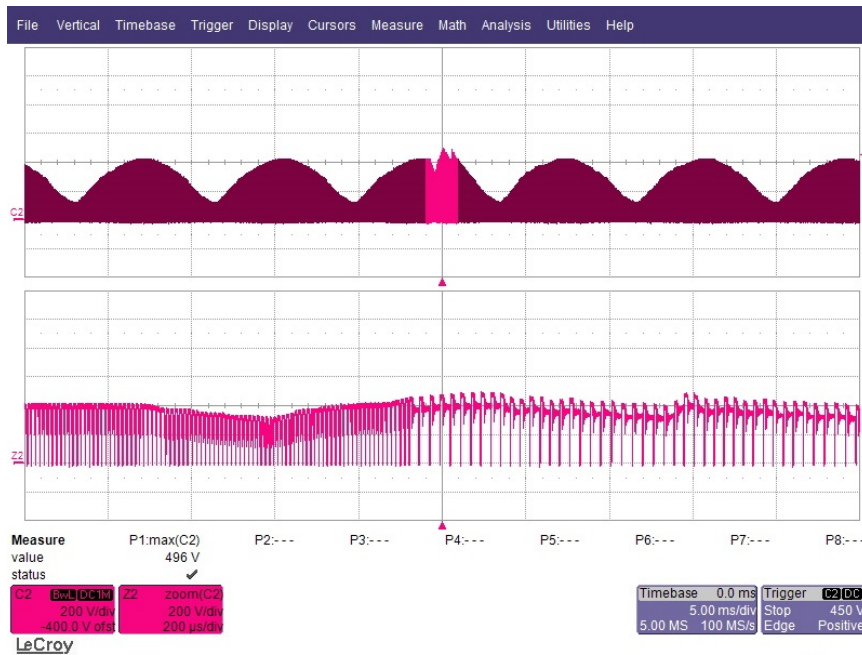

Figure 138 – (+)3.5 kV Ring Wave, 270° Phase.
 Upper: V_{DRAIN} , 200 V / div., 5 ms / div.
 Lower: $V_{DRAIN(ZOOMED)}$, 200 V / div., 100 μ s / div.
 Peak V_{DRAIN} : 515 V.

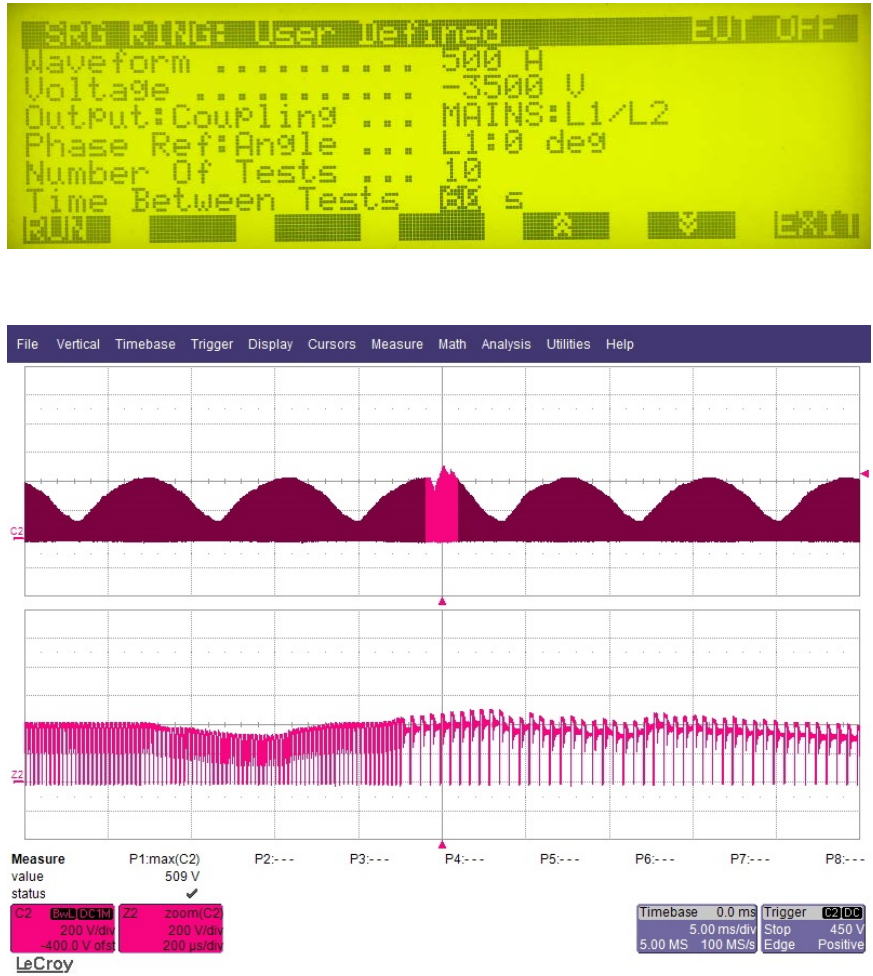

Figure 139 – (-)3.5 kV Ring Wave, 0° Phase.
 Upper: V_{DRAIN} , 200 V / div., 5 ms / div.
 Lower: $V_{DRAIN(ZOOMED)}$, 200 V / div., 100 μ s / div.
 Peak V_{DRAIN} : 509 V.

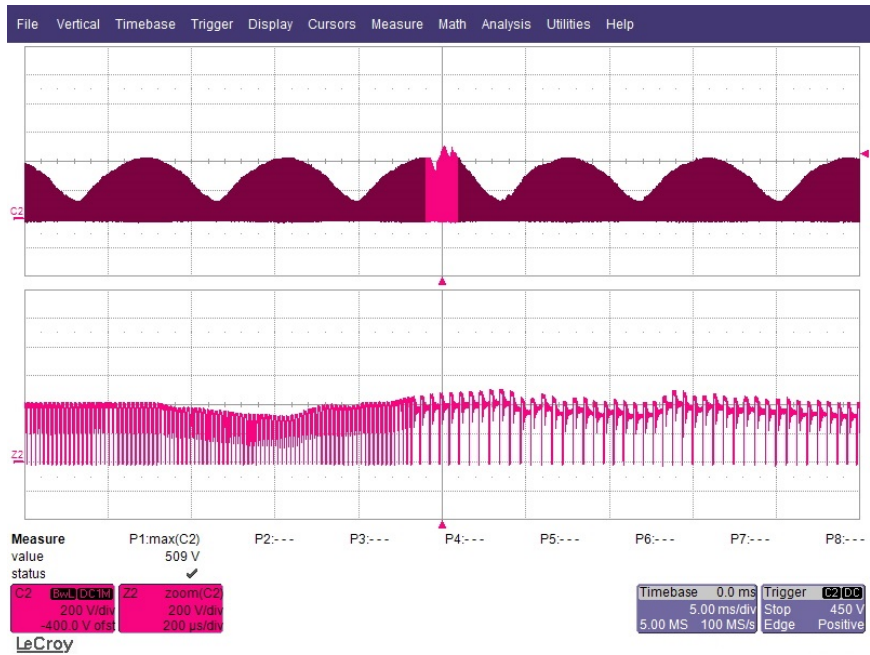
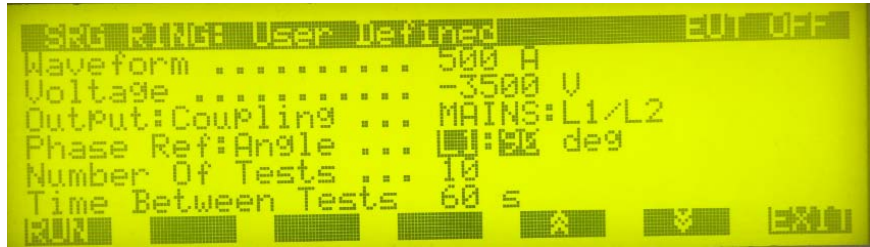

Figure 140 – (-)3.5 kV Ring Wave, 90° Phase.
 Upper: V_{DRAIN} , 200 V / div., 5 ms / div.
 Lower: $V_{DRAIN(ZOOMED)}$, 200 V / div., 100 μs / div.
 Peak V_{DRAIN} : 509 V.

17 Brown-in / Brown-out Test

No failure of any component was seen during brownout test of 1 V / sec AC cut-in and cut-off.

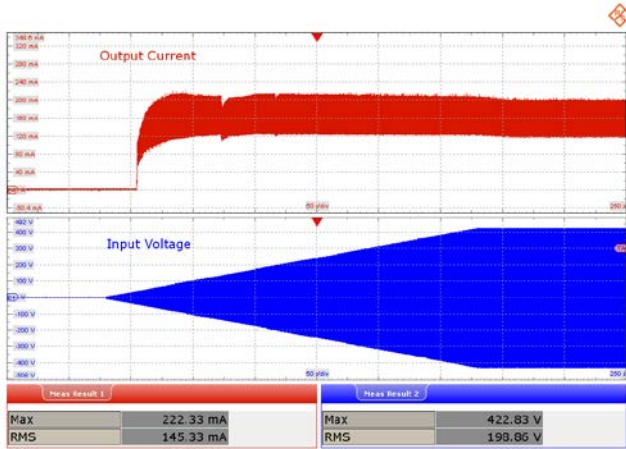

Figure 142 – Brown-in Test at 0.5 V / s, 300 VAC. The unit is able to operate normally without any failure and without flicker. Upper: I_{OUT} , 40 mA / div. Lower: V_{IN} , 100 V / div. Time Scale: 50 s / div.

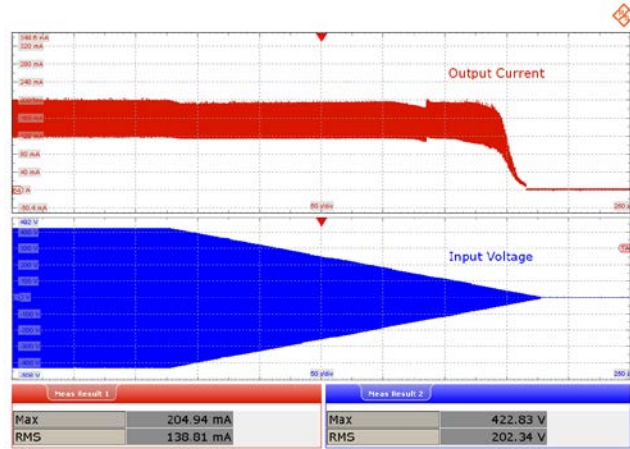

Figure 143 – Brown-out Test at 1 V / s, 0 VAC. The unit is able to operate normally without any failure and without flicker. Upper: I_{OUT} , 40 mA / div. Lower: V_{IN} , 100 V / div. Time Scale: 50 s / div.

18 Revision History

Date	Author	Revision	Description and Changes	Reviewed
25-Jan-16	AO	1.0	Initial Release.	Apps & Mktg
30-Mar-16	KM	1.1	Added Transformer Supplier.	



For the latest updates, visit our website: www.power.com

Power Integrations reserves the right to make changes to its products at any time to improve reliability or manufacturability. Power Integrations does not assume any liability arising from the use of any device or circuit described herein. POWER INTEGRATIONS MAKES NO WARRANTY HEREIN AND SPECIFICALLY DISCLAIMS ALL WARRANTIES INCLUDING, WITHOUT LIMITATION, THE IMPLIED WARRANTIES OF MERCHANTABILITY, FITNESS FOR A PARTICULAR PURPOSE, AND NON-INFRINGEMENT OF THIRD PARTY RIGHTS.

Patent Information

The products and applications illustrated herein (including transformer construction and circuits' external to the products) may be covered by one or more U.S. and foreign patents, or potentially by pending U.S. and foreign patent applications assigned to Power Integrations. A complete list of Power Integrations' patents may be found at www.power.com. Power Integrations grants its customers a license under certain patent rights as set forth at <http://www.power.com/ip.htm>.

The PI Logo, TOPSwitch, TinySwitch, LinkSwitch, LYTSwitch, InnoSwitch, DPA-Switch, PeakSwitch, CAPZero, SENZero, LinkZero, HiperPFS, HiperTFS, HiperLCS, Qspeed, EcoSmart, Clampless, E-Shield, Filterfuse, FluxLink, StackFET, PI Expert and PI FACTS are trademarks of Power Integrations, Inc. Other trademarks are property of their respective companies. ©Copyright 2015 Power Integrations, Inc.

Power Integrations Worldwide Sales Support Locations**WORLD HEADQUARTERS**

5245 Hellyer Avenue
San Jose, CA 95138, USA.
Main: +1-408-414-9200
Customer Service:
Phone: +1-408-414-9665
Fax: +1-408-414-9765
e-mail: usasales@power.com

GERMANY

Lindwurmstrasse 114
80337, Munich
Germany
Phone: +49-895-527-39110
Fax: +49-895-527-39200
e-mail: eurosales@power.com

JAPAN

Kosei Dai-3 Building
2-12-11, Shin-Yokohama,
Kohoku-ku, Yokohama-shi,
Kanagawa 222-0033
Japan
Phone: +81-45-471-1021
Fax: +81-45-471-3717
e-mail: japansales@power.com

TAIWAN

5F, No. 318, Nei Hu Rd.,
Sec. 1
Nei Hu District
Taipei 11493, Taiwan R.O.C.
Phone: +886-2-2659-4570
Fax: +886-2-2659-4550
e-mail:
taiwansales@power.com

CHINA (SHANGHAI)

Rm 2410, Charity Plaza, No. 88,
North Caoxi Road,
Shanghai, PRC 200030
Phone: +86-21-6354-6323
Fax: +86-21-6354-6325
e-mail: chinasales@power.com

INDIA

#1, 14th Main Road
Vasanthanagar
Bangalore-560052
India
Phone: +91-80-4113-8020
Fax: +91-80-4113-8023
e-mail: indiasales@power.com

KOREA

RM 602, 6FL
Korea City Air Terminal B/D,
159-6
Samsung-Dong, Kangnam-Gu,
Seoul, 135-728 Korea
Phone: +82-2-2016-6610
Fax: +82-2-2016-6630
e-mail: koreasales@power.com

UK

Cambridge Semiconductor,
a Power Integrations company
Westbrook Centre, Block 5,
2nd Floor
Milton Road
Cambridge CB4 1YG
Phone: +44 (0) 1223-446483
e-mail: eurosales@power.com

CHINA (SHENZHEN)

17/F, Hivac Building, No. 2, Keji
Nan 8th Road, Nanshan District,
Shenzhen, China, 518057
Phone: +86-755-8672-8689
Fax: +86-755-8672-8690
e-mail: chinasales@power.com

ITALY

Via Milanese 20, 3rd. Fl.
20099 Sesto San Giovanni (MI)
Italy
Phone: +39-024-550-8701
Fax: +39-028-928-6009
e-mail: eurosales@power.com

SINGAPORE

51 Newton Road,
#19-01/05 Goldhill Plaza
Singapore, 308900
Phone: +65-6358-2160
Fax: +65-6358-2015
e-mail: singaporesales@power.com

