

**KEMET Part Number: C315C220J2G5TA**  
(C315C220J2G5TABULK)

Capacitor, ceramic, 22 pF, +/-5% Tol, 200 V, COG, Lead Spacing=0.1"

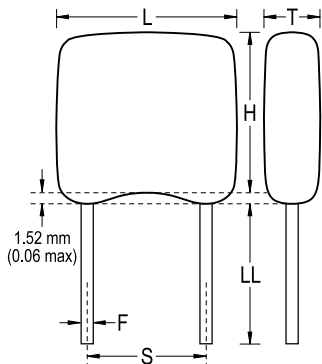

**Dimensions (mm)**

Symbol	Dimension	Tolerance
L	3.81	MAX
H	3.14	MAX
T	2.54	MAX
S	2.54	NOM
LL	7	MIN
F	0.51	NOM

**Packaging Specifications**

<b>Package Kind:</b>	Bulk
<b>Package Type:</b>	Bag
<b>Package Quantity:</b>	500

**General Information**

<b>Supplier:</b>	KEMET
<b>Application:</b>	General Purpose
<b>Temperature Coefficient:</b>	COG
<b>Body Type:</b>	Radial Conformal
<b>Lead Type:</b>	Wire Leads
<b>Termination Type:</b>	Tin (Sn)
<b>RoHS:</b>	Yes

**Specifications**

<b>Capacitance:</b>	22 pF
<b>Voltage:</b>	200 V
<b>Tolerance:</b>	+/-5%
<b>Temperature Range:</b>	-55/+125C
<b>Failure Rate:</b>	N/A
<b>Dissipation Factor:</b>	0.1%
<b>Insulation Resistance:</b>	100 GOhm
<b>Dielectric Strength:</b>	500 V