

KEMET Part Number: C320C103K5R5TA
(C320C103K5R5TABULK)

Capacitor, ceramic, 0.01 uF, +/-10% Tol, 50 V, X7R, Lead Spacing=0.1"

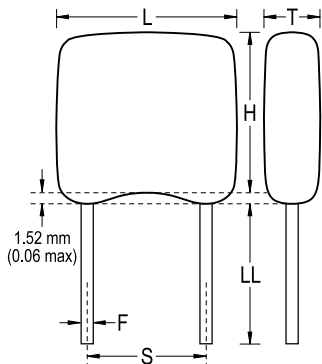

Dimensions (mm)

Symbol	Dimension	Tolerance
L	5.08	MAX
H	5.84	MAX
T	3.18	MAX
S	2.54	NOM
LL	7	MIN
F	0.51	NOM

Packaging Specifications

Package Kind:	Bulk
Package Type:	Bag
Package Quantity:	500

General Information

Supplier:	KEMET
Application:	General Purpose
Temperature Coefficient:	X7R
Body Type:	Radial Conformal
Lead Type:	Wire Leads
Termination Type:	Tin (Sn)
RoHS:	Yes

Specifications

Capacitance:	0.01 uF
Voltage:	50 V
Tolerance:	+/-10%
Temperature Range:	-55/+125C
Failure Rate:	N/A
Dissipation Factor:	2.5%
Insulation Resistance:	100 GOhm
Dielectric Strength:	125 V