

KEMET Part Number: LDEEA1120KA0N00
(DEEA1120KA0N00)

Capacitor, film, Metallized PEN (Stacked), 1200 pF, +/-10% Tol, General Purpose, 100 VDC@125C

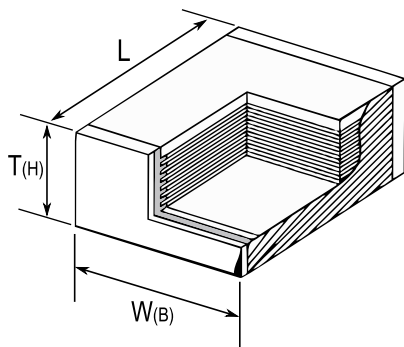

Note: '()' correspond to the letters used in the product bulletin

Dimensions (mm)		
Symbol	Dimension	Tolerance
L	3.3	+0.3/-0.1
W	1.7	+/-0.2
T	1.1	MAX

Packaging Specifications	
Package Kind:	T&R
Package Size:	Standard
Package Quantity:	3000

General Information	
Supplier:	KEMET
Dielectric:	Metallized PEN (Stacked)
Application:	General Purpose
Sub Application:	AEC-Q200
Style:	Surface Mount
Chip Size:	1206 (3216 metric)
RoHS:	Yes

Specifications	
Capacitance:	1200 pF
Voltage:	100 VDC
Tolerance:	+/-10%
Voltage AC:	63 VAC
Rated Temperature:	125C
Temperature Range:	-55/+125C
Dissipation Factor @ 1 kHz:	0.8%
Insulation Resistance:	1 GOhm
Maximum dVdT:	100 v/us