

KEMET Part Number: PZB300MC11R30
(P300PL104M275AC222)

Capacitor, film, Metallized Paper, 0.1 uF, +/-20% Tol, -40/+100C, Delta EMI (X2+Y2+Y2), Lead Spacing=20 mm

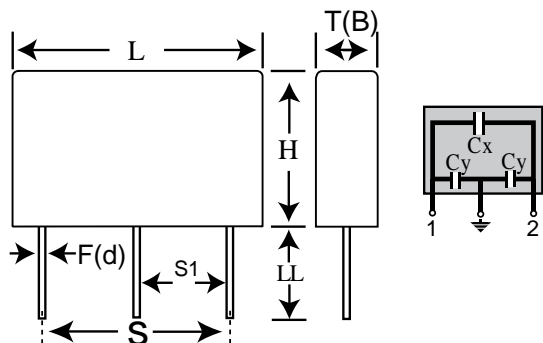

Note: '()' correspond to the letters used in the product bulletin

Dimensions (mm)		
Symbol	Dimension	Tolerance
L	24	MAX
H	16	MAX
T	12.5	MAX
S	20	+/-0.5
S1	10	NOM
LL	30	+5
F	0.8	+/-0.05

Packaging Specifications	
Package Kind:	Bulk
Package Quantity:	150

General Information	
Supplier:	KEMET
Dielectric:	Metallized Paper
Application:	Delta EMI (X2+Y2+Y2)
Style:	Radial Molded
Lead Form:	3 Lead
Features:	Pulse
RoHS:	Yes

Specifications	
Capacitance:	0.1 uF
Tolerance:	+/-20%
Voltage AC:	275 VAC
Rated Temperature:	100C
Temperature Range:	-40/+100C
Dissipation Factor @ 1 kHz:	1.3%
Insulation Resistance:	12 GOhm
Maximum dVdT:	600 v/us
Miscellaneous:	y2_cap_value= 0.0022 uF