

Capacitor, aluminum, 22 uF, +/-20% Tol, -25/+85C, 200 VDC@85C

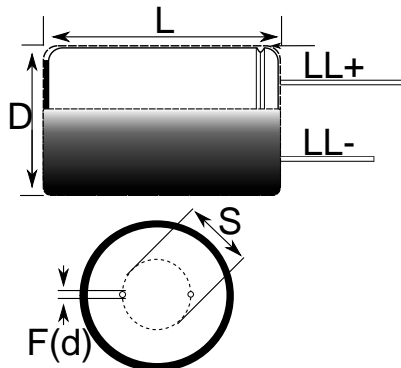

Note: '()' correspond to the letters used in the product bulletin

Dimensions (mm)		
Symbol	Dimension	Tolerance
D	10	+/-0.5
L	15	+2
S	5	+/-0.5
LLPos	20	MIN
LLNeg	15	MIN
F	0.6	NOM

Packaging Specifications	
Package Kind:	Bulk
Package Type:	Bag
Package Quantity:	3000

General Information	
Supplier:	KEMET
Application:	General Purpose
Part Type Description:	Single Ended, Aluminum Electrolytic
Lead Type:	Wire Leads
RoHS:	Yes

Specifications	
Capacitance:	22 uF
Voltage:	200 VDC
Tolerance:	+/-20%
Voltage:	250 VDC (Surge)
Life:	2000 Hrs
Rated Temperature:	85C
Temperature Range:	-25/+85C
Leakage Current:	142 uA
Leakage Condition:	uAmps (2min 20C)
Dissipation Factor:	15%
Impedance Ratio -25C:	7.0
Current/Ripple Current:	120 mAmps (120Hz 85C)